

**BAUMARKET**

Markat më të mira, shërbimi më i mirë



**KATALOGU  
2024-2025**



## Një mirëseardhje e ngrohtë në një nga filialet BAUMARKET!

Plot 75 filiale ku do të gjeni përzgjedhje fantastike produktesh me cilësi të lartë si dhe këshilla gjithëpërfshirëse nga specialistët tanë.

### Të nderuar klientë,

Pranvera zgjon energjinë tonë! Është koha më e mirë për të freskuar kopshtin dhe shtëpinë tuaj. Duke filluar nga korresët e barit dhe deri tek produktet për ambiente të jashtme. Mund të mbështeteni tek ne për të mirëmbajtur kopshtin tuaj. Përfitoni nga cilësia e lartë e produkteve tona.

Katalogu ynë i përgjithshëm ju ofron një përmbledhje gjithëpërfshirëse. Gama jonë e plotë e produkteve nga markat më cilësore deri te ato më të rejat dhe inovative.

### Nga frymëzimi tek zbatimi,

Në shumë faqe te veçanta të këtij katalogu mund të gjeni informacione të dobishme, udhëzime dhe ide frymezuese. Çfarëdo ideje që jeni duke kërkuar për projektin tuaj të radhës, në markatat tona do të gjeni zgjidhje. Tashmë me mbi 15,000 produkte nderimi, kopshtarie dhe shtëpie.

### Kultura e kreativitetit

Ne jemi të fokusuar vazhdimisht në ide, trende dhe inovacione.

### Ide dhe njohuri

Shumëllojshmëri e katalogëve dhe specialistëve tanë po rritet në menyrë të qëndrueshme.

Ne ju ofrojmë këshilla, histori frymëzuese dhe inovative. Pra, filloni të lexoni! Ju do të gjeni të gjitha informacionet që ju nevojiten në markatën tuaj me të afert kudo dhe në çdo kohë nëpërmjet telefonit, laptopit apo kompjuterit tuaj në adresën web:

[www.baumarket.al](http://www.baumarket.al)

Ekipi juaj **BAUMARKET**





**PRODUKTE EKSLUZIVE**  
Faqja A16-A160 & B1-B64

**MAKINERI**  
nga faqja 1

**AKSESORË**  
nga faqja 69

**MAKINERI NDËRTIMI**  
nga faqja 163

**MAKINERI SALDIMI**  
nga faqja 167

**KOMPRESORË AJRI**  
nga faqja 199

**PAISJE SERVISI**  
nga faqja 229

**VEGLA DORE**  
nga faqja 317

**SISTEME SIGURIE**  
nga faqja 393

**SISTEME FIKSIMI**  
nga faqja 415

**SPRAJ TEKNIK**  
nga faqja 441

**KORRËSE BARI**  
nga faqja 6

**MOTOKOSA**  
nga faqja 25

**MOTOSHARRA**  
nga faqja 43

**FREZA DHE SPËRKATËSE**  
nga faqja 69

**MOTOPOMPA**  
nga faqja 87

**LAVAZHE**  
nga faqja 121

**GËRSHËRË**  
nga faqja 136

**SHKALLË DHE SKELA**  
nga faqja 187

**ELEKTRIKE**  
nga faqja 211

**FAMILJARE**  
nga faqja 273



## **BAUMARKET ju ofron shumë përparësi në blerje:**

- ✔ **Markat tona ekskluzive me cilësi të lartë**  
(Faqe A14-A160, B1-B64)
  - ✔ **Praktike: Website BAUMARKET më shumë shërbime**  
(Me shumë informacion ne faqen 7)
  - ✔ **Shërbimi i qerasë me cmim fiks** (Me shumë ne faqen 8-9)
  - ✔ **Deri në 5% ulje per perdoruesit e kartës PRO\*** (Faqe 10)
  - ✔ **Shërbimi ynë për ju**  
(Përmbledhje në faqen 10)
  - ✔ **Deri në 5 vjet garanci për të gjitha makineritë tona elektrike dhe me bateri\*\*** (Faqe 10)
  - ✔ **Shërbimi i departamentit pas shitjes**  
(Më shumë në faqet 14 - 15)
  - ✔ **Karriera në BAUMARKET**  
(Përmbledhje në faqet 12 - 13)
- \* Përfshihet ofertat mujore dhe ato periodike
- \*\* Sipas kushteve të garancisë së prodhuesve



# ME NE JENI PLOTËSISHT I INFORMUAR



Për të gjithë profesionistët dhe të apasionuarit, katalogu ynë gjeneral sjell gjithcka që ju nevojitet për të ndryshuar, ridizajnuar dhe përmirësuar projektet tuaja.

KATALOGU YNË



Për më tepër vizitoni

Website **BAUMARKET**

[www.baumarket.al](http://www.baumarket.al)

Mund të na vizitoni edhe online. Në website BAUMARKET mund të gjeni shpejt produktin që kërkonte, të zbuloni lehtësisht gamën tonë të gjerë, të kontrolloni disponueshmërinë dhe të porosisni ose rezervoni lehtësisht në qendrën tuaj më të afërt. Ne jemi gjithashtu në dispozicion për t'ju ofruar një shumëllojshmëri këshillash në **baumarket.al**

## FLETËPALOSJA MUJORE



Përherë duke sjellë te ju produktet më cilësore dhe më të kërkuara të sezonit, më oferta dhe cmime konkurruese! Fletëpalosja BAUMARKET e bën më të thjeshtë fokusimin në produktet sezonale.



## NDËRTIMI

**FLEX**

**YATO**

**BOSCH** **airmec**

**TELWIN** **Fetti** **Henkel**

**Kistenberg** **heller**  
PREMIUM TOOLS

**AIR PRO** **BAU PRO**

## MAKINERI

**HIKOKI** **Einhell**

**INGCO** **WOLFOW**

## SALDIMI

**INGCO** **VOREL**

**TELWIN** **KEMPER**

## KOMPRESORË

**force** **FORCE**  
MACHINERY - TOOLS

**PREBENA** **CAV**

## LAVAZHE

**ANNOVI REVERBERI** **INGCO**  
The Power of Experience Professional Tools Made Affordable

**BORMANN** **KÄRCHER**

Ekskluzive në **BAUMARKET**

## MARKAT TONA EKSKLUZIVE ME CILËSI TË LARTË

Markat tona ofrojnë mundësi të pafundme për zgjedhje: produkte me cilësi të lartë, të testuara intesivisht në të gjitha fushat, me raportin më të mirë çmim - cilësi.

## VEGLA DORE

**MATADOR** **felo**  
SCHRAUBWERKZEUGE

**BMI** **Condor**  
werkzeug

## SIGURIA

**YUMA** **FORCE**  
MACHINERY - TOOLS

**WOLFOW** **YATO**

## BULLONERI

**KLIMAS** **orbofix**  
FASTENER TECHNOLOGIES

**NORM** **TORK**  
GROUP

## SPRAJ TEKNIK

**WD-40** **Selsil**

**TKK** **AMBRO-SOL**  
SINCE 1947 SPRAY

## GJELBËRIMI

**KÄRCHER** **STIGA**

**ANNOVI REVERBERI** **ABUS**  
The Power of Experience

**LIGHT PRO** **Ferretti**

**Steinbach** **Kfa**  
we are pool

**POWERED by HONDA** **INTEX**

## KORRËSE

**GARDENA** **AL-KO**  
QUALITY FOR LIFE

**Einhell** **solo**

## MOTOSHARRA

**INGCO** **McCULLOCH**  
Professional Tools Made Affordable

**NAKAYAMA** **OREGON**  
PRO

## GJENERATORË

**LAUNTOP** **FORCE**  
MACHINERY - TOOLS

**INGCO** **Einhell**  
Professional Tools Made Affordable

## POMPA UJI

**SPERONI** **FORCE**  
WATER PUMPS MACHINERY - TOOLS

**Einhell** **WOLFOW**



# NDIQNI BAUMARKET NË

## RRJETET SOCIALE

### #baumarketalbania

Frymëzim profesional, ide konkrete rinovimi dhe keshilla të rëndësishme për projektet, shtëpine dhe kopshtin tuaj. Të gjitha këto dhe më shumë mund ti gjeni në rrjetet tona sociale!



[facebook.com/baumarketalbania](https://facebook.com/baumarketalbania)

Tutoriale, keshilla, promovime dhe evente të përzgjedhura për ndjekësit tanë.

Linked 

[linkedin.com/baumarketalbania](https://linkedin.com/baumarketalbania)

Prezantimi i kompanisë dhe njoftime të periodike punësimi



[instagram.com/baumarket.albania](https://instagram.com/baumarket.albania)

Oferta, frymëzim dhe ide të vazhdueshme!

# BAUMARKET

 TikTok

[tiktok.com/baumarketalbania](https://tiktok.com/baumarketalbania)

Video demonstruese, reklamuese dhe humoristike.

YouTube 

[youtube.com/baumarketalbania](https://youtube.com/baumarketalbania)

Video udhëzuese dhe prezantuese të produkteve!



Të krijosh diçka me duart e tua,  
çfarë ndjesie e mrekullueshme!  
Klientë të panumërt BAUMARKET ndërtojnë,  
rinovojne, krasisin, sharrojnë, lyejnë dhe  
dizenjojnë çdo ditë me produktet më ciësore.



# REZERVO DHE BLI ONLINE. KËSHTU BËHET:

## GJEJ VENDENDDHJEN

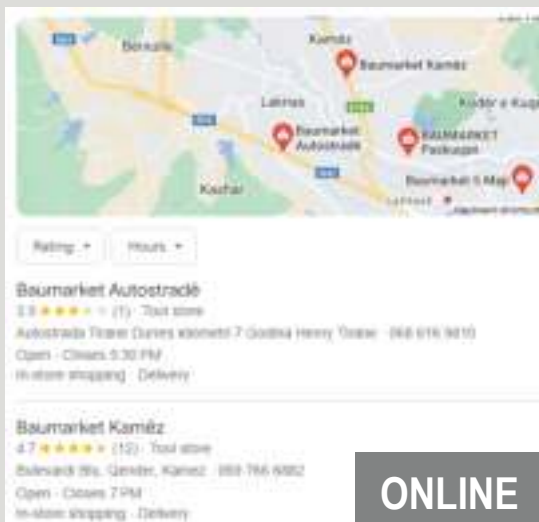

## ZGJIDHNI PRODUKTIN

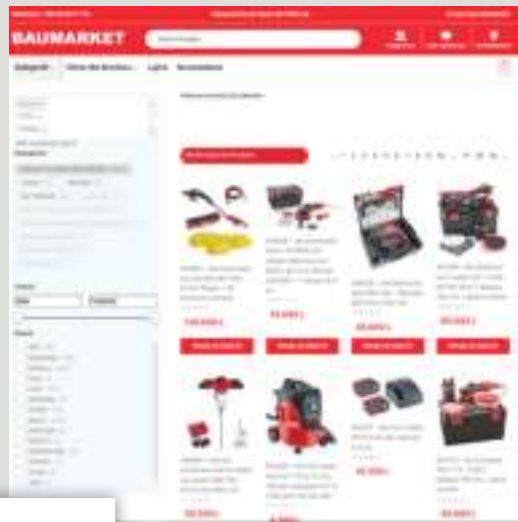

ONLINE

REZERVO



TËRHIQ

NË MARKATË

## FIZIKISHT

Produktet mund ti gjeni në të gjitha markatat BAUMARKET

## BLERJA ONLINE

Blerja Online është gjithashtu shumë e thjeshtë me anë të website [baumarket.al](http://baumarket.al)



NË QËNDRAT E SPECIALIZUARA BAUMARKET!



# SHËRBIMI YNË I MAKINERIVE ME QERA

Kurseni investimin në pajisjet që i përdorni rrallë. Me shërbimin tonë praktik të dhënies me qera, ju mund të merrni të gjitha makineritë që ju nevojiten, me cmime të përballueshme dhe fleksibël.



## Ne japim me qera makineritë për punët e mëposhtme:

- Shëmbje muresh
- Punimi i tokës
- Shpimi në beton
- Kopshtari
- Bujqësi
- Përzjerje
- Prerje dhe ndarje
- Punë në lartësi
- Transport
- Sharrim

## Të gjitha avantazhet e qerasë:

- ✓ Të gjitha makineritë mund të rezervohen me telefon ose email.
- ✓ Rimorkio makinash për transportin e makinerive të mëdha.
- ✓ Teknologjia dhe funksionimi i pajisjeve shpjegohen në detaje nga stafi ynë i specializuar.
- ✓ Tarifa e përcaktuar për çdo kohëzgjatje qiraje: afatshkurtër, ditore, fundjavë, etj.



Shfletoni më shumë në fletëpalosjen e **MAKINERIVE ME QERA**

Fletëpalosja online gjendet në linkun: [www.baumarket.al/makineri-me-qera](http://www.baumarket.al/makineri-me-qera)  
Skano kodin për ta aksesuar!

Shënim: Të gjitha produktet në këtë fletëpalosje mund të blihen në të gjitha markatat BAUMARKET!



**DUSS**

Matrapik për thyerje

**Husqvarna**

Makineri për prerje dhe kositje

**KRAUSE**

Shkallë dhe Skela

**HIKOKI**

Vidiator, Trapan, Matrapik

**FLEX**

Zmeriluese dhe Aspiratorë



## Kontrolli i garancisë



Për tu siguruar që të gjitha paisjet tona me qera janë në gjëndje të përsosur, ato mirëmbahen rregullisht. Sigurisht, ne përfshijmë në gamë vetëm ato produkte që plotësojnë kushtet e duhura të sigurisë dhe standartet e larta.

## Tarifat më të rëndësishme



**Tarifë Afatshkurtër**  
4 orë



**Tarifë Ditore**  
24 orë



**Tarifë Fundjave**  
Premte 13:00  
E Hënë 10:00



**Tarifë Javore**  
Duke nisur nga 7 ditë

## Shembull i paisjeve me qera:

### Matrapik PK 600 A

Matrapik për thyerje. Përdoret për punimet me daltë në beton, për hapjen e mureve etj. Me dorëzë shtesë për punë të rënda. Fuqi e lartë në cdo përdorim.

### Të dhënat teknike

Pesha: 17.4 kg  
Mandrino: 22 mm  
Fuqia: 2000 W



Paisje me qera: Matrapik

Duke filluar nga:

**25 €**

Tarifa e qerasë:

AFATSHKURTËR	DITORE	FUNDJAVË	JAVORE	KAPAR
25 €	35 €	59 €	150 €	250 €

## Shërbimi ynë i qerasë funksionon thjeshtë:

**1** Përzgjedhja e paisjes ose makinerisë me ndihmën e stafit tonë të specializuar BAUMARKET.



**2** Udhëzime nga specialistët tanë. Shpjegim gjithëpërfshirës i paisjeve dhe aksesoreve të nevojshëm.



**3** Përcaktimi i periudhës së përdorimit dhe paguani depozitën me para në dorë ose me kartë krediti duke treguar kartën tuaj të identitetit.



**4** Transportoni me automjetin tuaj ose nëpërmjet shërbimit të dërgesës të markatës BAUMARKET.



**5** Kthimi i kaparit pas dorëzimit të produktit në kohën e caktuar në gjendjen e tërhequr nga markata. Aksesoret e papërdorur mund të kthehen nga markata.



Makineri pastrimi dhe lëmimi



Makineri për përpunimin e betonit dhe asfaltit



Prerja dhe ndarje betoni



Gjeneratorë dhe Motopompa



Makineri pastrimi



Makineri për përpunimin e parketit

# PER CDO RAST: SHËRBIMI YNË PËR JU:

Përveç gamës tonë të madhe, ka shërbime të dobishme që e bëjnë blerjen në BAUMARKET një përvojë të kompletuar. Informacioni kryesor është pika kryesore e komunikimit. Këtu do të gjeni informacione për të gjithë gamën tonë të shërbimeve.

## TRANSPORTI

Ju nuk keni nevojë të mbani vetë mallra me peshë të rëndë, por BAUMARKET e sjell tek ju. Ne sjellim blerjet në vendndodhjen tuaj, për një tarifë minimale, duke bërë blerjen tek ne një eksperiencë sa më të thjeshtë.



## SHËRBIM ME QERA

Nëse është e nevojshme, mund të merrni me qera vegla dhe makineritë ndryshme nga markatat BAUMARKET, me kosto të ulët dhe të përshtatshme. Ne ofrojmë rekomandime dhe udhëzime mbi produktin.



## GARANCIA JONË

### Profesionalizëm dhe cilësi e garantuar



BAUMARKET

Ne jemi kaq të sigurt në cilësinë e produkteve tona sa që ofrojmë një zgjatje të garancisë deri në 5-vjet, për të gjitha paisjet tona elektrike dhe me bateri.

Cdo blerje malli në markatat BAUMARKET është i kontrolluar dhe i testuar për cilësinë që ofron. Mallrat me defekt i kthehen menjëherë furnitorit. Ne e përfshijmë një produkt në gamën tonë vetëm nëse ai produkt ka kaluar kontrollin tonë të brendshëm të cilësisë.

## INFORMACIONI

Këtu profesionistët dhe zejtarët e apasionuar mund të marrin përgjigje, për të gjitha pyetjet e tyre në lidhje me shërbimet tona. Qofshin ofertat për sasi të mëdha, pranimi i porosive dhe marrëveshjet e dorëzimit. Punonjësit tanë të specializuar janë pranë jush me këshilla profesionale.



## GAMA

Gjithmonë të përditësuar dhe të disponueshëm në sasi të mëdha, për cdo profesionist. Kjo ju jep një avantazh të rëndësishëm çmimi, pasi çmimi i negociuar, është i mundur kur shiten sasi të mëdha. Pyesni për kushtet tona në markatën më të afërt dhe merrni ofertën tuaj.



## CILËSI

BAUMARKET

E GARANTUAR

BAUMARKET

KARTA

PRO



## KARTA PRO

Cdo biznes apo individ mund të përfitojë nga karta pro një sërë avantazhesh të ndryshme, duke nisur nga uljet e ndryshme, si dhe kohëzgjatja e garancisë normale në 5 vjet për cdo produkt.

- Rritje e garancisë për cdo produkt
- 5% ulje për produktet ekskluzive
- Oferta të dedikuara
- Dhurata të ndryshme





# womens power

by **BAUMARKET**

Me produktet tona të ofertës mujore, projektet tuaja janë edhe më argëtuese! Sepse këto vegla do tju vijnë në ndihmë çdo ditë!



Çekic  
HMH82200 **360 L**



Kominoshe  
masa M  
KMP052.M

**1.250 L**

Nivelues Kit me  
metër dhe laps  
dhuratë  
HSL38040M

## Me shumë këshilla dhe informacione ne broshurat tona!

Broshurat tona "Women's Power" ju ofrojnë artikuj frymëzues për  
shtëpinë dhe kopështin tuaj. Mund ta gjeni në të gjitha markatat  
BAUMARKET ose online në [baumarket.al](http://baumarket.al)





**Ne po rritemi dhe  
ofrojmë rregullisht  
pozicione të reja pune.  
Filloje karrierën tënde  
2024, në rrjetin me të  
madh të markatave  
industriale në vend!**

**Apliko tani!**

[www.baumarket.al/pune/](http://www.baumarket.al/pune/)

# NDERTOJE TË ARDHMEN TËNDE!

## Karriera në #TeamBaumarket



- Pagesa të larta
- Planifikim i mirë i detyrave
- 30 ditë pushim, 5 ditë në javë



- Aktivitete argëtuese
- Mbështetje personale dhe profesionale
- Respekt dhe punë në ekip



- Rritje profesionale
- Përgjegjësi dhe vendimarrje
- Mundësi për trajnime të mëtejshme

**Ndiqni, pëlqeni dhe informohuni!**

Na ndiqni ne kanalet tona të rrjeteve sociale:







## Departamenti i Shërbimit pas Shitjes i kompletuar me pjesë këmbimi origjinale!



Kemi investuar në një **stok të qëndrueshëm** me rreth 5.000 pjesë këmbimi. Të gjitha pjesët e këmbimit janë **origjinale** për të siguruar cilësi dhe përputhshmëri totale.

Kthimi sa më shpejt i veglave tuaja përsëri funksionale është prioriteti ynë. Procedurat e mirëorganizuara, teknologjia e avancuar dhe specialistët e mirëtrajnuar, bëjnë të mundur që shumica e riparimeve mos të zgjasin më tepër se **5 ditë**.



# KUDO PRANË JUSH!



## Servis për të gjitha markat tona deri

në **5** ditë



**BOSCH**







## Servisi ynë kryen shërbime unike dhe të specializuara të riparimit për çdo produkt.

- ✓ Riparon dhe ofron garancinë për të gjitha markat sipas kushteve të parapërcaktuara.
- ✓ Staf i specializuar dhe i mirëtrajnuar, me përvojë shumë vjeçare në fushën e riparimit të veglave dhe makinerive.
- ✓ Ofrojmë informacion mbi fazat e riparimit të veglave falë organizimit dhe kompjuterizimit të proceseve.

### Kontrolli

- ✓ Pastrimi i veglave
- ✓ Diagnostikimi i motorit
- ✓ Kontrolli i bobinave
- ✓ Kontrolli i rrjedhjeve

### Riparimi

- ✓ Rivendosja e pajisjes në gjendje funksionale
- ✓ Zëvendësimi me pjesë këmbimi origjinale
- ✓ Kontrolli i funksionalitetit



*Sipërfaqe e re e Servisit prej 300m<sup>2</sup> me ambiente më moderne, për të përmirësuar organizimin dhe cilësinë e riparimeve*



#### Rrjeti më i madh gjerman për aksesoret e sporteve ujore

Nisni lundrimin dhe ngrini spirancën me BAUMARKET NAUTICA. Në një atmosferë të ndritshme dhe miqësore, të apasionuarit e sporteve ujore, si dhe operatorët e marinave dhe kantierëve detare, mund të gjejnë një gamë të gjerë produktesh, me cilësi të lartë dhe shërbim profesional, në dyqanet tona të specializuar.

#### Këshilla Kryesore

Kërkoni informacion nga punonjësit tanë specialist që pëlqejnë sportet ujore, të cilët kanë përvojë përkatëse në sektorin detar.



#### INFO

CILËSIA E LARTË NUK DUHET TË JETË E SHKURTËR

Markat cilësore prodhohen ekskluzivisht për BAUMARKET nga prodhues të përzgjedhur global.

Nga prodhimi te testimi i cilësisë, BAUMARKET monitoron çdo hap të procesit. Rezultati është produkte me cilësi të lartë me një raport optimal çmim - cilësi.

Cilësia dhe siguria është shumë e rëndësishme në aventurat ujore, dhe për këtë arsye BAUMARKET sigurohet që çdo aktivitet ujor të jetë i kënaqshëm për ju dhe miqtë tuaj, duke ofruar paisjet më të mira të këtij sektori dhe duke ruajtur një balancë të kënaqshme të raportit çmim - cilësi.

Mund të gjeni mbi 1000 produkte sportive ujore në website tonë: [www.baumarket.al](http://www.baumarket.al)



#### Markat më cilësore, me çmimet më të mira

Robline

Yachticon

TOHATSU

YACHTCARE

Henkel

TORQUEDO

SIMRAD

POWERED by HONDA

TALAMEX

INTEX



**100**  
**YEARS**  
**FLEX**

Ekskluzive në  
**BAUMARKET**



**FLEX**

SPONSOR ZYRTAR

**ERE**



**ERE**

Zmeriluese Muresh  
Trupi me fiber karboni  
Fuqia 500 w / 225 mm

Pistoletë Dadiçekësh 1/2"  
Motori pa karbonçina 18V  
Fuqia shtrënguese 406 Nm

# Tani me XLITHIUM POWER PLUS

Bateria e re FLEX 18 V me 8.0 Ah. Shërbim shtesë dhe kohë më të gjatë funksionimi për më shumë performancë.

## + Performancë

Dendësia më e lartë e energjisë së baterisë të re mundëson deri në 75% më shumë fuqi për produkte të përzgjedhura.\*\*

THERMA-TEC  
**X LITHIUM  
POWER PLUS**



**E RE**

## + Kohëzgjatje

Nëpërmjet teknologjisë moderne të qelizave arrihet deri në 60% kohë më e gjatë funksionimi.\*

\* Krahasuar me AP 18.0/5.0Ah  
\*\* - Sharrë rrethore me bateri CS 62 18.0-EC  
- Trapan me dy marshe me bateri PD 2G 18.0-EC HD  
- Tronkatrice me bateri 18.0-ECarritur.\*

## + Jetëgjatësi

FLEX Therma-Tech™  
Materiali i përdorur në të gjitha bateritë FLEX 18.0 V thith nxehtësinë e gjeneruar gjatë përdorimit, duke siguruar kohë më të gjatë të funksionimit të baterisë dhe cikle të larta të jetëgjatësisë.

### Paketat e baterive Li-Ion

Mbrojtje e integruar e karikimit dhe shkarkimit. Mbrojtje nga pluhuri dhe nga spërkatjet e ujit. Treguesi i integruar i nivelit të karikimit, informon menjëherë për gjendjen e ngarkimit të qelizave të baterisë.

#### AP 18.0 V

**E RE**

**18.0**  
Battery voltage



Kodi	417890	445894	521078
AP 18.0 V	2.5 Ah	5.0 Ah	8.0 Ah
Çmimi	8.900	15.900	24.900

#### AP 10.8 V

**10.8**  
Battery voltage



Kodi	418048	439657
AP 10.8 V	2.5 Ah	4.0 Ah
Çmimi	7.900	11.500

**3**

JAHRE

FLEX GARANTIE

### 3 vite garanci Gjithashtu vlen për paketat e baterive dhe karikuesëve!

Shikoni anën e pasme për detaje

#### P-Set 22 W

- Tensioni 10.8/18.0 Volt
- 2x Bateri 18 V / 5.0 Ah



Kodi	491349
Çmimi	29.500

#### P-Set 22 Q

- Tensioni 18.0 Volt
- 2x Bateri 18 V / 2.5 Ah



Kodi	491357
Çmimi	19.500



# Performancë e patentuar Sistemi i baterisë jep atë që premton!

Kohë e gjatë funksionimi, jetë e gjatë shërbimi, performancë e lartë.

Vetëm FLEX mund ta bëjë këtë: Me sistemin e patentuar të ftohjes, FLEX arrin mbrojtjen optimale të veglës dhe të qelizave të baterisë. Sistemi i menaxhimit të baterisë kontrollon shkëmbimin e përhershëm të të dhënave ndërmjet veglës, baterisë dhe karikuesit, në mënyrë që të gjithë parametrat të jenë optimale. Kjo siguron fuqi në bashkëpunimin midis baterisë dhe veglës dhe mundëson përdorimin pa humbje energjie



## Keep Control

Teknologjia SMART kontrollon dhe monitoron aktivitetin e veglës dhe procesin e karikimit të baterisë duke informuar nga Ekran LCD mbi gjendjen e karikimit.



## Therma-Tech™

Sistemi i veçantë i integruar i ftohjes siguron temperaturë konstante qoftë edhe në ngarkesa të larta pune



## Power Battery

Li-Ion i fuqishëm kujdesen qelizat Fuqia 18 V.



## Lithium-Ion

Asnjë vetë-shkarkim. Nuk ka efekt kujtese.



## EC-Motor

Me konsum të ulët dhe motor pa karboncina me teknologjinë EC për më shumë pune, më shumë fuqi dhe më shumë Jetëgjatësi.



Makineri me Bateri



Teknologjia  
Therma-Tech™



Karikues



## Karikues CA 10.8

- për bateritë 10,8 V
- Ftohje e integruar e baterive, mbrojtje mbinxehja, shkarkimi dhe mbingarkesa
- Me ekran LED të statusit të karikimit



**Koha e karikimit të baterive 10.8 V**  
 • 40 min për baterinë 2,5 Ah  
 • 50 min për baterinë 4,0 Ah

**Kodi** 418021  
**Çmimi** 8.5-00

## Karikues CA 10.8 / 18.0

- për bateritë 10,8 V / 18.0 V
- Ftohje e integruar e baterive, mbrojtje mbinxehja, shkarkimi dhe mbingarkesa
- Ekran LCD



**Koha e karikimit të baterive 10.8 V**  
 • 40 min për baterinë 2,5 Ah  
 • 50 min për baterinë 5,0 Ah

**Kodi** 417882  
**Çmimi** 8.900



Ekрани LCD me format të madh, me kohën e ngarkimit dhe treguesi i gjëndjes së karikimit tregon kohën e mbetur të karikimit.

# FLEX

## pack



### 3 MUNDËSI ZGJEDHJEJE

Ju mund të zgjidhni më shumë se një herë të njejtën makineri

! Kur te porositni vendosni edhe FLEX PAC numer 497.444 Perveç kodit te makinerise

**18.0**  
Battery voltage

ARTIKULLI. 491233



Trapan me goditje me 2 marshe me bateri PD 2G 18.0

ARTIKULLI. 515698



Trapan me goditje me 2 marshe me bateri PD 2G 18.0-EC HD C

ARTIKULLI. 491292



Trapan me 4 marshe me bateri DD 4G 18.0-EC C

ARTIKULLI. 520756



Vidiator me goditje me bateri ID 1/4" 18.0-EC HD C

ARTIKULLI. 491241



Vidiator me goditje me bateri ID 1/4" 18.0-EC C

ARTIKULLI. 492612



Pistoletë dadicekesh me bateri IW 3/4" 18.0-EC C

ARTIKULLI. 530189



Pistoletë dadicekesh me bateri IW 1/2" 950 18.0-EC C

ARTIKULLI. 491268



Pistoletë dadicekesh me bateri IW 1/2" 18.0-EC C

ARTIKULLI. 530231



Pistoletë dadicekesh me bateri IW 1/2" 750 18.0-EC C

ARTIKULLI. 491276



Vidiator gipsi me bateri DW 45 18.0-EC C

ARTIKULLI. 491314



Matrapik SDS-Plus me bateri CHE 2-26 18.0-EC C

ARTIKULLI. 491284



Matrapik SDS-Plus me bateri CHE 18.0-EC C

ARTIKULLI. 499285



Gurë fleksibel me reostat me bateri LBE 125 18.0-EC C

ARTIKULLI. 417939



Sharre rrethore me bateri CS 62 18.0-EC

ARTIKULLI. 489794



Sharre me lama vertikale me bateri JSB 18.0-EC C

ARTIKULLI. 485403



Sharre me lama vertikale me bateri JS 18.0-EC C

ARTIKULLI. 417874



Sharre me lama horizontale me bateri RS 29 18.0-EC C

ARTIKULLI. 481491



Aspirator me bateri VC 6 L MC

ARTIKULLI. 472921



Ndricues kantieri me bateri CL2000

ARTIKULLI. 486728



Llampe LED me bateri DWL 2500 10.8 / 18.0 V

ARTIKULLI. 504637



Ndricues me bateri WL 2800 18.0 V

ARTIKULLI. 484857



Radio kanteri me bateri RD 10.8/18.0/230

ARTIKULLI. 503002



Ventilator me bateri CF 18.0/230

ARTIKULLI. 506648



Kompresor me bateri CI 11 18.0



#### Set Baterie

Bateri Li-ion  
AP 18.0 / 5.0 Ah  
1 x Karikues i shpejte  
CA 10.8 / 18.0



#### Çante

1 x çante  
praktike per  
mbajtjen e  
veglave e perforcuar



**99.000**



**18.0**  
Battery  
voltage

**LI-ION**  
Lithium-ion  
technology

**KEEP CONTROL**  
Technology

**Therma-Tech™**  
Technology

**BRUSHLESS  
EC-MOTOR**



**18.0 V**  
**Li-Ion**  
Power System

**25.900**

**491314**  
Matrapik SDS-Plus  
me bateri  
**CHE 2-26 18.0-EC C**  
Forca Goditese: 2.6 J  
Motor pa karboncina  
Kapaciteti shpimit Beton  
/ dru / metal 26 / 30 / 13 mm  
Pesha: 3.18 kg



**22.500**



**29.900**

**491292**  
Vidiator / trapan me goditje  
me 2 marshe me bateri  
**PD 2G 18.0-EC FC C**  
Force shtrengimi: 65 Nm  
Motor pa karboncina  
Nr rrotullimeve 0 - 4200 rpm  
Pesha 1.5 kg

**520756**  
Vidiator me goditje  
me bateri  
**ID 1/4" 18.0-EC HD C**  
Force shtrengimi: 237 Nm  
Kapja 1/4"  
Pesha 1.2 kg



**48.500**

3 Bateri 18 V 5.0 Ah  
**AP 18.0/5.0**  
Pesha: 0.72 kg

Karikues baterie 18 V  
**CA 10.8/18.0**  
Amperazhi: 9.0 Ah



**6.500**

~~133.200~~

**99.000**

**Eksluzive**

Cante per vegla  
**FBL 700/400**

**18.0**  
Battery  
voltage

**LI-ION**  
Lithium-ion  
technology

**KEEP CONTROL**  
Technology

**Therma-Tech™**  
Technology

**BRUSHLESS  
EC-MOTOR**



**25.900**

**18.0 V**  
**Li-Ion**  
Power System

**491314**  
Matrapik SDS-Plus  
me bateri  
**CHE 2-26 18.0-EC C**  
Forca Goditese: 2.6 J  
Motor pa karboncina  
Kapaciteti shpimit Beton  
/ dru / metal 26 / 30 / 13 mm  
Pesha: 3.18 kg



**28.500**

**499307**  
Gure fleksibel me bateri  
**LB 125 18.0-EC C**  
Disku: 125 mm  
Kapja: M14  
Nr rrotullimeve bosh: 9000 rpm  
Pesha: 1.85 kg



**26.900**

**519049**  
Vidiator / Trapan me  
2 bateri 18 V / 2.5 Ah  
**DD 2G 18.0-EC LD**  
Force shtrengimi: 65 Nm  
Mandrino metalike  
Motor pa karboncina



**x2**

**520756**  
Vidiator  
me goditje  
me bateri  
**ID 1/4" 18.0-EC HD C**  
Force shtrengimi: 237 Nm  
Kapja 1/4"  
Pesha 1.2 kg

**29.900**

2 Bateri  
18 V / 5.0 Ah  
**P-Set 22 W**  
Pesha: 0.72 kg



**x2**

Karikues  
baterie 18 V  
**CA 10.8/18.0**



**33.500**



**6.500**

Cante per vegla  
**FBL 700/400**

~~151.200~~

**125.000**

**Eksluzive**

# FLEX starter pack

**18.0**  
Battery  
voltage

**LI-ION**  
Lithium-ion  
technology

**KEEP CONTROL**  
Technology

**Therma-Tech™**  
Technology

**BRUSHLESS  
EC-MOTOR**

**515698**

Vidiator / Trapan  
me goditje me bateri  
**PD 2G 18.0-EC HD C**  
Force shtrengimi: 158 Nm  
Mandrino: 1.5 - 13 mm  
Motor pa karboncina  
Pesha: 1.7 kg



**25.900**



**22.500**

**530231**

Pistoletë dadicekesh  
me bateri  
**IW 1/2" 18.0-EC C**  
Force shtrenguese: 750 Nm  
Kapja 1/2"  
Motor pa karboncina  
Pesha 1.9 kg

**417939**

Sharre rrethore  
me bateri  
**CS 62 18.0-EC**  
Disku 165 mm  
Kendi 0 / 22,5 / 45 / 50°  
Motor pa karboncina  
Nr rrotullimeve bosh: 5000 rpm  
Pesha 3.1 kg



**26.500**

2 Bateri 18 V 5.0 Ah  
**AP 18.0/5.0**  
Pesha:0.72 kg



**33.500**

**18.0 V**  
**Li-Ion**  
Power System



**6.500**

Cante per vegla  
**FBL 700/400**



~~114.900~~

**89.000**

**Ekskluzive**

**18.0**  
Battery  
voltage

**LI-ION**  
Lithium-ion  
technology

**KEEP CONTROL**  
Technology

**Therma-Tech™**  
Technology

**BRUSHLESS  
EC-MOTOR**

**519049**

Vidiator / Trapan me bateri  
**DD 2G 18.0-EC LD**  
Force shtrengimi: 65 Nm  
Mandrino metalike  
Motor pa karboncina  
N rrotullimeve 1800 / min

**18.0 V**  
**Li-Ion**  
Power System



**26.900**



2 Bateri + karikues  
18 V / 2.5 Ah  
Pesha:0.72 kg

**520756**

Vidiator  
me goditje me bateri  
**ID 1/4" 18.0-EC HD C**  
Force shtrengimi: 237 Nm  
Kapja 1/4"  
Pesha 1.2 kg

**29.900**

**22.900**



~~86.200~~

**59.000**

**Ekskluzive**

Cante per vegla  
**FBL 700/400**

**6.500**

**18.0**  
Battery  
voltage

**LI-ION**  
Lithium-ion  
technology

**KEEP CONTROL**  
Technology

**Therma-Tech™**  
Technology

**BRUSHLESS  
EC-MOTOR**

**18.0 V**  
**Li-Ion**  
Power System



**26.900**

**492612**

Pistoletë  
dadicekesh me bateri  
**IW 3/4" 18.0-EC C**  
Force shtrenguese max:  
1050 Nm  
Motor pa karboncina  
Pesha: 3.3 kg

**499285**

Gure fleksibel  
me reostat me bateri  
**LBE 125 18.0-EC C**  
Disku 125 mm  
Motor pa karboncina  
Pesha 1.85 kg



**26.500**



2 Bateri + karikues  
18 V / 5.0 Ah  
**P-Set 22 W**  
Pesha:0.72 kg

**33.500**

**6.500**

~~93.400~~

**79.000**

**Ekskluzive**

Cante per  
vegla  
**FBL 700/400**





## JENI NJË SPECIALIST GIPSI?

Zgjidhni FLEX PACK që ju përshtatet.

Me Çmimin më të mirë në treg.



**18.0**  
Battery voltage

**LI-ION**  
Lithium-ion technology

**EMS**  
KEEP CONTROL Technology

**Therma-Tech™**  
Technology

**BRUSHLESS EC-MOTOR**

**491276**  
Vidiator gipsi me bateri  
**DW 45 18.0-EC C**  
Kapja: 1/4"  
Force shtrengimi 250 Nm  
Motor pa karboncina  
Pesha: 1.7 kg

**21.500**

**BRUSHLESS EC-MOTOR**

**18.0**  
Battery voltage

**LI-ION**  
Lithium-ion technology

**EMS**  
KEEP CONTROL Technology

**Therma-Tech™**  
Technology

**504041**  
Zmeriluese muri me bateri  
**GE MH 18.0-EC/ 5.0 Set+MH-R**  
Rrotullimi kokes 100°  
Motor pa karboncina  
Gjatesia kabellit 5 m  
Pesha 2.8 kg

**49.900**



**23.900**

**491284**  
Matrapik SDS-Plus me bateri  
**CHE 18.0-EC**  
Force goditese: 1.7 J  
Motor pa karboncina  
Pesha 2.0 kg

**417874**  
Sharre me lama horizontale me bateri  
**RS 29 18.0**  
Kapacitet prerje 29 mm  
Motor pa karboncina  
Pesha

**18.900**

2 Bateri 18 V 5.0 Ah  
**AP 18.0/5.0**  
Pesha:0.72 kg

**33.500**

Karikues baterie 18 V  
**CA 10.8/18.0**  
Amperazhi: 9.0 Ah



Cante per vegla  
**FBL 700/400**

**6.500**

~~104.300~~

**89.000**

**Ekskluzive**



**11.500**

**472921**  
Ndricues kantieri me bateri  
**CL 2000 18.0**  
Ndricimi 1200 / 2000 lm  
Pesha 2.4 kg

2 Bateri 18 V 5.0 Ah  
**AP 18.0/5.0**  
Pesha:0.72 kg

**33.500**

Karikues baterie 18 V  
**CA 10.8/18.0**  
Amperazhi: 9.0 Ah



Cante per vegla  
**FBL 700/400**

**6.500**

~~122.900~~

**99.000**

**Ekskluzive**

**VIDIATOR / TRAPAN ME GODITJE 18 V**

**PD 2G 18.0-EC HD C**

**25.900**

**515698**



Bateri 18 V  
Force shtrengimi 158 Nm  
Mandrino 1.5 - 13 mm  
Motor Pa karboncina  
Pesha 1.7 kg  
Vetem trup

**VIDIATOR / TRAPAN ME GODITJE 18 V**

**PD 2G 18.0-EC C**

**19.900**

**491233**



Bateri 18 V  
Force shtrengimi 90 Nm  
Mandrino 1.5 - 13 mm  
Motor Pa karboncina  
Pesha 1.6 kg  
Me 2 marshe Vetem trup

**VIDIATOR / TRAPAN ME GODITJE 18 V**

**PD 2G 18.0-EC FS**

**29.900**

**516171**



Bateri 2 x 18 V / 5.0 Ah  
Force shtrengimi 75 Nm  
Mandrino 1.5 - 13 mm  
Motor Pa karboncina  
Me 2 marshe

**VIDIATOR / TRAPAN ME GODITJE 18 V**

**PD 2G 18.0-EC LD**

**25.900**

**519057**



Bateri 2 x 18 V / 2.5 Ah  
Force shtrengimi 65 Nm  
Mandrino 1.5 - 13 mm  
Motor Pa karboncina  
Me 2 marshe

**VIDIATOR / TRAPAN 18 V**

**DD 2G 18.0-EC C**

**19.500**

**491225**



Bateri 18 V Ah  
Force shtrengimi 90 Nm  
Mandrino 1.5 - 13 mm  
Nr rrotullimeve 0-2300 / min  
Pesha 1.5 kg  
Vetem trup

**VIDIATOR / TRAPAN 18 V**

**DD 2G 18.0-EC LD**

**24.900**

**519049**



Bateri 2 x 18 V / 2.5 Ah  
Force shtrengimi 65 Nm  
Mandrino Metalike  
Motor Pa karboncina  
Nr rrotullimeve 1800 / min  
Pesha 1.7 kg

**VIDIATOR / TRAPAN 18 V**

**DD 4G 18.0-EC C**

**22.500**

**491292**



Bateri 18 V  
Force shtrengimi 65 Nm  
Mandrino 1.5 - 13 mm  
Motor Pa karboncina  
Nr rrotullimeve 0 - 4200 rpm  
Pesha 1.5 kg  
Vetem trup

**VIDIATOR ME GODITJE 18 V**

**ID 1/4" 18.0-EC HD C**

**29.900**

**520756**



Bateri 18 V  
Kapja 1/4"  
Force shtrengimi 237 Nm  
Marshe 3  
Motor Pa karboncina  
Pesha 1.2 kg  
Vetem trup



### VIDIATOR ME GODITJE 18 V

**ID 1/4" 18.0-EC C**

**22.500**

491241



Bateri	18 V
Kapja	1/4"
Force shtrengimi	225 Nm
Nr rrotullimeve	0-2500/min
Pesha	1.1 kg
	Vetem trup



### PISTOLETE DADICEKESH 18 V

**E RE**

**IW 1/2" 400 18.0-EC C**

**24.900**

531502



Bateri	18 V
Kapja	1/2"
Force shtrenguese max	400 Nm
Motor	Pa karboncina
Pesha	1.2 kg
	Vetem trup



### PISTOLETE DADICEKESH 18 V

**IW 3/4" 18.0-EC C**

**26.900**

492612



Bateri	18 V
Kapja	3/4"
Force shtrenguese max	1060 Nm
Motor	Pa karboncina
Pesha	3.3 kg
	Vetem trup



### PISTOLETE DADICEKESH 18 V

**IW 1/2" 950 18.0-EC C**

**27.900**

530189



Bateri	18 V
Kapja	1/2"
Force shtrenguese max	950 Nm
Motor	Pa karboncina
Pesha	3.1 kg
	Vetem trup



### PISTOLETE DADICEKESH 18 V

**IW 1/2" 750 18.0-EC C**

**22.500**

530231



Bateri	18 V
Kapja	1/2"
Force shtrenguese max	750 Nm
Motor	Pa karboncina
Pesha	1.9 kg
	Vetem trup



### VIDIATOR GIPSI 18 V

**DW 45 18.0-EC C + P SET**

**31.900**

505943



Bateri	2 X 18 V / 2.5 Ah
Kapja	1/4"
Force shtrengimi	250 Nm
Motor	Pa karboncina



### VIDIATOR GIPSI 18 V

**DW 45 18.0-EC C**

**21.500**

491276



Bateri	18 V
Kapja	1/4"
Force shtrengimi	250 Nm
Motor	Pa karboncina
Pesha	0.975 kg
	Vetem trup



### KOKE AUTOMATIKE

**M-DW 55**

**14.900**

463698



Per vida	25-55 mm
Diametri i vides	4.2 mm
Koke e rrotullueshme	360°
Pesha	0.5 kg

### MATRAPIK SDS-PLUS 18 V

**CHE 2-26 18.0-EC C**

**25.900**

**491314**



Bateri 18 V  
Kapja SDS-Plus  
Force goditese 2.6 J  
Kapaciteti shpimit Beton /dru /metal 26 mm / 30 / 13 mm  
Motor Pa karboncina  
Vetem trup 3.18 kg

### MATRAPIK SDS-PLUS 18 V

**CHE 18.0-EC C**

**23.900**

**491284**



Bateri 18 V  
Kapja SDS-Plus  
Force goditese 1.7 J  
Kapaciteti shpimit Beton /dru /metal 18 mm / 20 / 13 mm  
Motor Pa karboncina  
Vetem trup 2.0 kg

### GURE FLEKSIBEL 18 V

**LBE 125 18.0-EC C**

**23.900**

**499285**



Me reostat



Bateri 18 V  
Disku 125 mm  
Nr rrotullimeve 3500/4500/6500/9000 rpm  
Kapja M14  
Motor Pa karboncina  
Pesha 1.85 kg  
Vetem trup

### SET LUCIDUESE 18 V

**XFE 15 150 18.0-EC/5.0 P-Set**

**39.900**

**461237**



Bateri 2 X 18 V / 5.0 Ah  
Max sip. punes 160 mm  
Nr rrotullimeve bosh 2300-3800 rpm  
Pesha 2.1 kg  
+ paste lucidimi



### SET POLIATRICE 18 V

**PE 150 18.0-EC/5.0 P-Set**

**39.900**

**461229**



Bateri 2 X 18 V / 5.0 AH  
Max sip. punes 160 mm  
Nr rrotullimeve bosh 150-1450 rpm  
Pesha 2.9 kg  
+ paste lucidimi



### SHARRE ME LAMA VERTIKALE 18 V

**JSB 18.0-0-EC C**

**23.900**

**489794**



Bateri 18 V  
Nr rrotullimeve bosh 0 - 3500 rpm  
Kapacitet prerje 120 mm  
Kendi prerjes 0 - 45°  
Motor Pa karboncina  
Pesha 2.1 kg  
Vetem trup

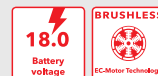

### SHARRE ME LAMA VERTIKALE 18 V

**JS 18.0-EC C**

**19.900**

**485403**



Bateri 18 V  
Nr rrotullimeve bosh 0 - 3500 rpm  
Kapacitet prerje 120 mm  
Kendi prerjes 0 - 45°  
Motor Pa karboncina  
Pesha 2.1 kg  
Vetem trup



### SHARRE ME LAMA HORIZONTALE 18 V

**RS 29 18.0 C**

**18.900**

**417874**



Bateri 18 V  
Nr rrotullimeve bosh 0 - 3100 rpm  
Kapacitet prerje 29 mm  
Pesha 2.9 kg  
Motor Pa karboncina  
Vetem trup

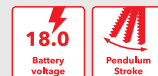



**SHARRE RRETHORE 18 V**
**CS 62 18.0-EC**
**19.900**
**417939**

Bateri 18 V  
 Disku 165 mm  
 Nr rrotullimeve bosh 5000 rpm  
 Kendi 0 / 22,5 / 45 / 50°  
 Motor Pa karboncina  
 Pesha 3.1 kg  
 Vetem trup

**SET ME PERZJERESE KOLLI 18 V**
**MXE 18.0-EC + SET**
**39.900**
**469092**

Bateri 2 X 18 V / 5.0 Ah  
 Kapja M14  
 Shufer 120 mm  
 Motor Pa karboncina  
 Pesha 4.1 kg

**SET ZMERILUESE GIRAFFE 18 V**
**GE MH 18.0-EC  
 5.0 Set+MH-R**
**49.900**
**504041**

Bateri 2 x 18 V / 5.0 Ah  
 Tamponi 225 mm  
 Rrotullimi kokes 100°  
 Nr rrotullimeve bosh 1150 - 1800 rpm  
 Motor Pa karboncina  
 Gjatesia e kabellit 5 m  
 Pesha 2.8 kg

**NDRICUES KANTIERI 18 V**
**CL 2000 18.0**
**9.900**
**472921**

Bateri 18 V  
 Ndricimi 1200 / 2000 lm  
 Pesha 2.4 kg

**ASPIRATOR 18 V**
**VC 6 L MC 18.0**
**18.500**
**481491**

Bateri 18 V  
 Depozite 6 Lt  
 Vakumi 12000 Pa  
 Shkalla e rrjedhjes 1400 m³/h  
 Pesha 3.3 kg  
 Vetem trup

**VIDIATOR / TRAPAN ME GODITJE 10.8 V**
**PD 2G 10.8-EC**
**19.900**
**501484**

Bateri 2 x 10.8 V / 2.5 Ah  
 Force shtrengimi 58 Nm  
 Mandrino 1.5 - 13 mm  
 Pesha 1.14 kg

**VIDIATOR / TRAPAN ME GODITJE 10.8 V**
**PD 2G 10.8-EC**
**15.900**
**501484/1**

Bateri 10.8 V  
 Force shtrengimi 58 Nm  
 Mandrino 1.5 - 13 mm  
 Pesha 1.14 kg

**VIDIATOR / TRAPAN 10.8 V**
**DD2G 10.8-LD/2.5**
**12.500**
**516155**

Bateri 2 X 10.8 V / 2.5 Ah  
 Force shtrengimi 34 Nm  
 Dia. Shpimit celik / dru 10 / 25 mm  
 Pesha 0.875 kg

### GURE FLEKSIBEL

**L8-11 125**

**8.900**

**494682**



Fuqja 800 W  
Disku 125 mm  
Nr rrotullimeve 12000 rpm  
Kapja M 14  
Gjatesia e kablilit 4.0 m  
Pesha 2.0 kg

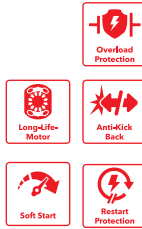

### GURE FLEKSIBEL ME REOSTAT

**LE 9-11 125**

**17.900**

**512818**



Me reostat

Fuqja 900 W  
Disku 125 mm  
Nr rrotullimeve 6000-11500 rpm  
Kapja M 14  
Gjatesia e kablilit 4.0 m  
Pesha 2.0 kg

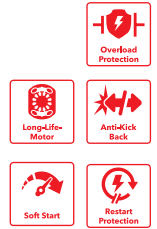

### GURE FLEKSIBEL

**L 1001 230**

**11.900**

**438340**



Fuqja 1010 W  
Disku 125 mm  
Nr rrotullimeve 10000 rpm  
Kapja M 14  
Gjatesia e kablilit 4.0 m  
Pesha 2.0 kg



### GURE FLEKSIBEL PA KARBONCINA

**L13-10 125-EC**

**22.500**

**495255**



BRUSHLESS

Fuqja 1300 W  
Disku 125 mm  
Nr rrotullimeve 10000 rpm  
Kapja M 14  
Gjatesia e kablilit 4.0 m  
Pesha 2.0 kg

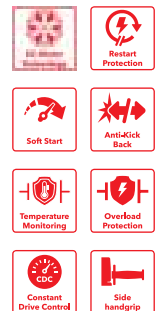

### GURE FLEKSIBEL ME REOSTAT

**LE 14-7 125**

**29.900**

**406546**



Me reostat

Fuqja 1400 W  
Disku 125 mm  
Nr rrotullimeve 2100-7500 rpm  
Kapja M 14  
Gjatesia e kablilit 4.0 m  
Pesha 2.4 kg

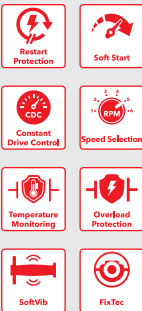

### GURE FLEKSIBEL

**L 2200 230**

**18.500**

**492280**



Fuqja 2.200 W  
Disku 230 mm  
Nr rrotullimeve 6500 rpm  
Kapja M 14  
Gjatesia e kablilit 4.0 m  
Pesha 5.8 kg



### GURE FLEKSIBEL

**L 26-6 230 TK-S**

**37.900**

**466239**



Fuqja 2600 W  
Disku 230 mm  
Nr rrotullimeve 6500 rpm  
Kapja M 14  
Gjatesia e kablilit 4.0 m  
Pesha 6.35 kg

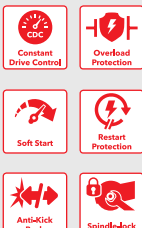

### GURE FLEKSIBEL ME ADAPTOR PLUHURI

**L 26-6 230**

**69.500**

**494631**



Fuqja 2.600 W  
Disku 230 mm  
Nr rrotullimeve 6500 rpm  
Kapja M 14  
Gjatesia e kablilit 4.0 m  
Pesha 9.18 kg  
+ Disk diamanti 230 mm





### HAPESE KANALI RF SET

**MS 1706**

**89.500**

**329673**

Fuqia 1.400 W  
Disku 140 mm  
Nr rrotullimeve 6500 rpm  
Thellesia e prerjes 0-35 mm  
Gjatesia e kabellit 4.0 m  
Pesha 4.6 kg



### MATRAPIK SDS-PLUS

**CHE 2-28**

**19.900**

**413666**

Fuqia 800 W  
Force goditese 2.7 J  
Nr rrotullimeve 0-1300 rpm  
Shpimi metal/beton/dru 13 / 26 / 30 mm  
Kapja SDS-Plus  
Pesha 2.65 kg



**E RE**



### MATRAPIK SDS-PLUS

**CHE 2-28**

**22.900**

**532028**

Fuqia 800 W  
Force goditese 2.7 J  
Nr rrotullimeve 0-1300 rpm  
Shpimi metal/beton/dru 13 / 26 / 30 mm  
Kapja SDS-Plus  
Pesha 2.65 kg

+ adaptor per thithjen e pluhurit



**I RI**

### MATRAPIK SDS-PLUS

**CHE 4-32**

**45.900**

**452335**

Fuqia 900 W  
Force goditese 4.8 J  
Nr rrotullimeve 0-650 rpm  
Shpimi metal/beton/dru 13 / 32 / 32 mm  
Kapja SDS-Plus  
Pesha 4.6 kg

+ 7 Punto + 7 dalta



### ZMERILUESE RRETHORE PA KARBONCINA

**ORE3-150 EC**

**37.500**

**447684**

Fuqia 400 W  
Nr rrotullimeve 6000-10000 rpm  
Diametri 150 mm  
Orbita oshilimit 3mm



### ZMERILUESE RRETHORE PA KARBONCINA

**ORE5-150 EC**

**37.500**

**447706**

Fuqia 400 W  
Nr rrotullimeve 4000-10000 rpm  
Diametri 150 mm  
Orbita oshilimit 5mm



### ZMERILUESE RRETHORE PA KARBONCINA

**ORE5-150 EC**

**39.900**

**507482**

Fuqia 400 W  
Nr rrotullimeve 4000-10000 rpm  
Diametri 150 mm  
Orbita oshilimit 5 mm  
Pesha 1.4 kg  
+ set me 200 letra

100 x P80



100 x P120



### POLIATRICE ELEKTRIKE

**PE 14-2 150**

**49.900**

**373680**

Fuqia 1400 W  
Nr rrotullimeve 2600 rpm  
Diametri 150 mm  
Orbita oshilimit 3 mm  
Pesha



## SET ASPIRATOR

**VC 21 L MC**

**29.500**

**409979**

Fuqja 1000 W  
Thithja 3600 l/min  
Vakumi 12000 PA  
Siperfaqja filtrit 3000 cm<sup>2</sup>  
Depozita 20 Lt  
Pesha 7.4 kg

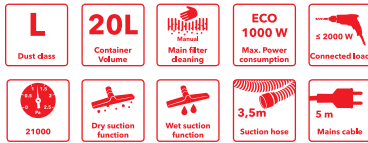

## SET ASPIRATOR

**VCE33LAC**

**79.000**

**471186**

Fuqja 1200 W  
Thithja 4500 l/min  
Vakumi 25000 PA  
Siperfaqja filtrit 5000 cm<sup>2</sup>  
Depozita 30 Lt  
Pesha 15.2 kg



## ASPIRATOR ME SHKUNDJE

**VCE 44 LAC**

**85.000**

**471208**

Fuqja 1200 W  
Thithja 4500 l/min  
Vakumi 25000 PA  
Siperfaqja filtrit 5000 cm<sup>2</sup>  
Depozita 42 Lt  
Pesha 16.7 kg



## PERZJERESE KOLLI ME 1 MARSH

**MXE 1000**

**E RE**

**24.900**

**531035**

Fuqja 1010 W  
Shufra perzjeresë 120 mm  
Kapja M14  
Gjatesia kabellit 4.0 m  
Nr rrot bosh 0-580 / 0-780 rpm  
Pesha 4.5 kg



## PERZJERESE KOLLI ME 2 MARSHE

**MXE 1202**

**29.900**

**497304**

Fuqja 1200 W  
Shufra perzjeresë 140 mm  
Kapja M14  
Gjatesia kabellit 4.0 m  
Nr rrot bosh 0-580 / 0-780 rpm  
Pesha 4.5 kg



## PERZJERESE KOLLI ME 2 MARSHE

**MXE 1602**

**47.500**

**497312**

Fuqja 1600 W  
Shufra perzjeresë 160 mm  
Kapja M14  
Gjatesia kabellit 4.0 m  
Nr rrot bosh 0-580 / 0-780 rpm  
Pesha 5.0 kg



## ZMERILUESE MURI GE 5 ECO

**GE 5 ECO**

**79.900**

**474835**

Fuqja 500 W  
Tamponi 225 mm  
Kendi rrotullimit 100°  
Gjatesia kabellit 5.0 m  
Nr rrot bosh 1100-1650 rpm  
Gjatesia totale 1520 mm  
Pesha 3.9 kg



## SET ZMERILUESE MURI GE 6 CARBON

**GE 6 R-EC**

**E RE**

**99.900**

**530900**

Fuqja 500 W  
Tamponi 225 mm  
Kendi rrotullimit 160°  
Gjatesia kabellit 5.0 m  
Nr rrot bosh 1100-1680 rpm  
Gjatesia totale 1520 mm  
Pesha 2.84 kg

**ME FIBER KARBONI**

**50% ME E LEHTE**





**ZMERILUESE MURESH**
**GE 7+MH-R+SH**
**135.000**
**494534**

Fuqja	710 W
Shufra perzjerese	225 mm
Kapja	M14
Gjatesia kabellit	4.0 m
Nr rrot bosh	1100-1650 rpm
Pesha	4.2 kg

**NIVELUES KRYQ ME LASER JESHIL**
**ALC 2/1-G/R**
**29.500**
**509833**

Preçizioni	± 0,3 mm/m
Numri i rrezeve	4
Largësia e veprimit	20 m
Autonomi	6 h
Vetenivelimi	± 4 °
Linjat	360°/90°
Shkalla e mbrojtjes	IP54
Pesha	1.2 kg

**NIVELUES KRYQ ME LASER**
**ALC 8**
**39.500**
**458600**

Preçizioni	± 0.3 mm
Nr i rrezeve	4
Largësia e veprimit	20 m
Autonomi	6 h
Katesgoria	2
Linjat	390°/90°
Shkalla e mbrojtjes	IP54
Pesha	1.2 kg

**NIVELUES DIXITAL**
**ADL 120-P**
**14.900**
**476110**

Vetenivelimi	0.029°
Gjatesia	1200 mm
Autonomi	100 h
Pesha	1.51 kg
Shkalla mbrojtjes	IP65

**MATES DISTANCE ME LASER**
**ADM30**
**7.900**
**504599**

Preçizioni	± 3 mm
Largësia e veprimit	0.03-30 m
Klasi	2
Shkalla e mbrojtjes	IP54
Numerimi ne ekran	3000
Pesha	0.038 kg

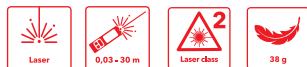
**MATES LARGESIE ME LASER**
**ADM 60 LI**
**14.900**
**447862**

Preçizioni	± 3 mm
Largësia e veprimit	0.15-60 m
Klasi	2
Shkalla e mbrojtjes	IP54
Pesha	0.13 kg

**MATES DISTANCE ME LASER**
**ADM70G**
**22.500**
**518956**

Preçizioni	± 3 mm
Largësia e veprimit	0.05-70 m
Klasi	2
Shkalla e mbrojtjes	IP54
Pesha	0.132 kg

**MATES DISTANCE ME LASER**
**ADM100G**
**27.900**
**518964**

Preçizioni	± 3 mm
Largësia e veprimit	0.05-100 m
Klasi	2
Shkalla e mbrojtjes	IP54
Pesha	0.132 kg



**KACAVIDE ME BATERI**

**SD 5-300**

**4.900**

530728



Bateri  
Nivele shpejtesie  
Nr rrotullimeve bosh  
Karikues  
Kapja

4.0 Ah  
3 Nivele  
5 - 300 rpm  
USB  
1/4"

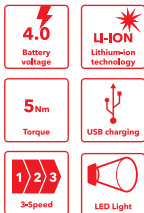

**SET ME 5 LAMA SHARRE 150 x 1.5 MM**

**Metal, plastik dhe dru**

462063

**1.990**



**SET ME 5 LAMA SHARRE 150 x 3 MM**

**Metal, plastik dhe dru**

462101

**1.990**



**SET ME 5 QESE FILTRI PER ASPIRATOR VC 21 L MC DHE VCE 26 LMC**

**5 x**

**FS-F VC/E 21-26 L**

502235

**4.900**



**FILTER ASPIRATORI PER VCE 35 L AC DHE VC 35 L MC**

**FS-F VC/E 35 VE5**

329630

**5.900**



**ADAPTOR PER ASPIRATOR**

**SAD-C D36/27 AS/NL**

408360

**2.900**



**TUB ASPIRATORI PER VCE 33/44 LAC ME ADAPTOR**

**SH-C 32x4m**

445037

**17.900**



**TAMPON PER ZMERILUESE MURESH**

**SP-X D225**

472603

**7.900**

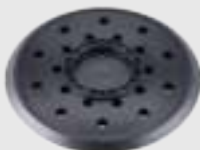

**TAMPON REZERVE PER ZMERILUESE MURESH**

**SP-EC S D150**

464112

**9.900**



**ADAPTOR PER TAMPONIN E ZMERILUESEVE GE 5, GE 5R, GSE 5 R**

**KAD D225/16 S**

483109

**3.500**



**ADAPTOR TAMPONI SFUNGJERE ME NGJITESE PER ZMERILUESE**

**KAD D225/16 H**

483117

**3.900**



**SFUNGJER PER ZMERILUESE MURESH**

**IP D225-10 VE2**

470678

**4.900**



**TAMPON PER ZMERILUESE MURESH**

**SP-M D225-10**

501352

**6.500**







Ekskluzive në **BAUMARKET**



**Vertetë Bosch!**  
**Vertetë Profesional!**



**VEGLA ME BATERI – PRO-MIX**

<p>1</p>  <p><b>1. Pistoletë dadiçekesh me bateri 'GDx 18V - 200 C Solo'</b> Bateria 18 V, 3 nivele shpejtesie 0 - 1,100 / 2,300 / 3,400 rpm, 0 - 4,000 rpm, Momenti i rrotullimit 200 Nm, me drite LED, pa bateri dhe karikues, 1,2 kg</p> <p><b>29.900</b></p>	<p>2</p>  <p><b>2. Matrapik SDS-Plus me bateri 'GBH 180 - LI Solo'</b> Bateria 18 V, Forca goditese 2 J, 51,000 ud / min, shpimi Ø ne dru / metal / beton: 30 / 13 / 4 - 20 mm, SDS plus, pa bateri dhe karikues, 2,3 kg</p> <p><b>39.900</b></p>	<p>3</p>  <p><b>3. Gure fleksibel me bateri 'GWS 180 - LI Solo'</b> Bateria 18 V, 11,000 rpm, disku Ø 125 mm, M14, celes me bllokim, pa bateri dhe karikues, 1,6 kg</p> <p><b>29.900</b></p>	<p>4</p>  <p><b>4. Sharre vertikale me bateri 'GWS 180 - LI Solo'</b> Bateria 18 V, 0 - 2,700 rrotullime / min, prerja max: dru/alumin/metal 120 / 20 / 8 mm, Kendi (majtas/djaththas): 45°, perfishire, 3 lama sharre, pa bateri dhe karikues, 1,8 kg</p> <p><b>29.900</b></p>	<p>5</p>  <p><b>5. Sharre horizontale me bateri 'GSA 18 V - LI C solo'</b> Bateria 18 V, me 2 nivele shpejtesie 0 - 3,050 rrotullime / min, prerja max: dru/hekur/tuba metalik: 260 / 8 / 150 mm, SDS plus, 3 lama sharre dhe valixhe 'L-Boxx 136', pa bateri dhe karikues, 2 kg</p> <p><b>24.900</b></p>
---	--	---	--	--

**SETE PROFESIONALE ME BATERI**

<p>6</p>  <p><b>6. Vidiator /Trapan me goditje me bateri 'GSB 18V - 50'</b> 18 V, 2 x 2 Ah, me 2 nivele shpejtesie: 0 - 460 / 1,800 / min, 27,000 rpm. / min, shpimi max ne. Ø dru/hekur/tulle: 35 / 10 / 10 mm, mandrino veteshtrenguese quick (13 mm), Momenti i rrotullimit me 2 marshe: 50 / 21 Nm , te perfishira 2 bateri, karikues dhe valixhe L-case, pesha (pa baterine): 0,99 kg</p> <p><b>39.900</b></p>	<p>7</p>  <p><b>7. Set Profesional me bateri: Pistoletë dadiçekesh me bateri 'GDx 180 - LI' + Vidiator me bateri 'GSR 180 - LI' 'GDx 180 - LI'</b> Nr rrotullimeve: 0 - 2,800 / min, nr goditjeve: 0 - 3,600 / min, Momenti max i rrotullimit: 180 Nm, kapje (1/4" and 1/2"), pesha: 1.1 kg 'GSR 180 - LI': nr rrotullimeve: 0 - 500 / 1,900 / min, Momenti rrotullimit (max/min): 54 / 21 Nm, Kapaciteti max i shpimit ne. Ø dru/celik, mandrino veteshtrenguese quick (13 mm), pesha: 1.0 kg, perfishire bateri, 2 x 2.0 Ah, karikues</p> <p><b>49.900</b></p>
--	--

8



**8. Set Profesional me bateri: Matrapik SDS-Plus 'GBH 180 - LI' + Vidiator 'GSR 180 - LI'**  
'GBH 180 - LI': Forca goditese: 2.0 J, nr rrotullimeve: 0 - 51,000 / min, Kapaciteti max i shpimit ne. Ø dru/metal: 30 / 13 mm, Ø shpimi ne beton: 4 - 20 mm, motor pa karboncina, pesha: 2.3 kg  
'GSR 180 - LI': nr rrotullimeve: 0 - 500 / 1,900 / min, Momenti rrotullimit (max/min): 54 / 21 Nm, Kapaciteti max i shpimit ne. Ø dru/celik : 35 / 10 mm, mandrino veteshtrenguese quick (13 mm), pesha: 1.0 kg. E pajisur me bateri: 2 x 18 V 4.0 Ah, karikues, cante

**69.900**

Perse te zgjidhni motora  
pa karboncina?

-  JETEGJATESI PUNE
-  KOHE E PERMIRESUAR
-  ME PAK ZHURME DHE NXEHJE
-  FORME E BALANCUAR DHE ERGONOMIKE



**BRUSHLESS**  
MOTOR





**VEGLA ELEKTRIKE**



**9.**  
Teknologjia COOLPACK 1.0  
Sistemi i baterisë  
**BOSCH PROFESSIONAL 18V**



**9. Starter kit**  
1 bateri 'GBA 18V 4.0 Ah', karikues  
'GAL 18V - 40'.  
Karikues i shpejte: 4.0 A

**15.900**

**10.**  
Teknologjia COOLPACK 1.0  
Sistemi i baterisë  
**BOSCH PROFESSIONAL 18V**



**10. Starter kit**  
2 bateri 'GBA 18V 4.0 Ah', karikues  
'GAL 18V - 40'. Karikues i shpejte: 4.0 A

**25.900**

**11.**  
Teknologjia COOLPACK 1.0  
Sistemi i baterisë  
**BOSCH PROFESSIONAL 18V**



**11. Starter kit**  
3 bateri 'GBA 18V 5,0 Ah',  
karikues 'GAL 18V - 40', Valixhe L - Boxx  
136', Karikues i shpejte: 4.0 A

**39.900**



**12. Zmeriluese Rrethore 'GEX 34-150'**  
Fuqia 340 W, Diametri tamponit 150 mm,  
Nr rrotullimeve Ø 9,000 – 24,000 /min,  
Pesha 2.1 kg

**29.000**

**14.**  
3 funksione – shpim, shpim me goditje,  
thyerje



**14. Matrapik SDS-Plus 'GBH 240'**  
Fuqia 790 W, Forca goditese 2.7 J,  
0 - 4,200 rrot / min, max. Ø per shpimin ne mur  
me punto gote / metal / dru: 68 / 13 / 30 mm, Ø  
per shpim ne beton: 4 - 24 mm, SDS plus,  
2.9 kg, perfshire valixhen dhe aksesore

**19.900**



**17. Gure fleksibel me reostat 'GWS 750 S'**  
Fuqia 750 W, 2,800 - 11,000 rpm, disku: Ø 125  
mm, celes me bilokim, mbrojtje nga rindjezja,  
nisje e butë, shpejtësi e ndryshueshme, pesha:  
1.8 kg

**9.900**

**13.**

**Doreze Antivibrimi per pune me te lehte  
SDS-Max**

**HEAVY DUTY**



**16. Matrapik SDS-Max 'GBH 5 - 40 DCE'**  
1.150 kW, forca goditese 8.8 J,  
1,500 - 3,050 rrot / min, SDS max, max.  
Ø shpimi ne beton me goditje: 12 - 40 /  
45 - 55 mm, Ø shpimi ne beton me punto:  
40 - 90 mm, pesha: 6.8 kg, perfshire 1 dalje  
me maje rumbullake

**79.000**

**15.**  
3 funksione – shpim, shpim me goditje,  
thyerje. Me kontroll kunder kthimit mbrapsht,  
per mbrojtjen e perdoruesit



**15. Matrapik SDS-Plus 'GBH 2-28 F'**  
Fuqia 880 W, Forca goditese 3.2 J, 0 – 1,300  
rrot / min, 0 - 4,200 rrot / max, max.  
Ø per shpimin ne mur me punto gote / metal /  
dru: 68 / 13 / 30 mm, Ø shpimi ne beton / ne  
beton me gote: 4 - 28 / 68 mm, perfshire  
mandrino shtese veteshtrenguese, valixhe dhe  
aksesore, 2.9 kg

**29.900**



**13. Trapan me goditje 'GSB 1600 RE'**  
Motor i fuqishem per aplikime te veshtrira.  
Doreze e bute per pune te rehatshme. Me kontroll  
shpejtesie elektronik. Fuqia: 701W, Mandrino metalike  
veteshtrenguese 13mm, Nr. rrotullimeve 0-3000  
rpm/min. Diametri i shpimit në beton /armature/dru/celik  
16/18/30/12mm, Pesha 1.9 kg

**17.900**



**18. Gure fleksibel 'GW22-230 JH'**  
Motor i fuqishem per punim te shpejte  
Fuqia 2200W, Disku 230mm  
Nr. rrotullimeve 6500 rpm/min  
Pesha 5.2 kg

**19.900**



**19. Sharre vertikale 'GST 8000 E'**  
Fuqia 710 W, 800 - 3,100 rrot / min,  
thellësia max e prerjes dru/ alumini / çeliku 90 / 20  
/ 10 mm, përfshirë lama reserve dhe mbrojtëse,  
Pesha: 2.5 kg

**24.900**



# 2018 BIONIC PRO SDS-Plus PUNTO SDS-Plus ME 2 KOKA



Shpejtësi shpimi e larte per rezultate profesionale ne beton te perforcuar

- ✓ Preres i dyfishte per beton te perforcuar dhe celikut
- ✓ Jetegjatesi sherbimi fale celikut special
- ✓ Dridhje te uleta qe lehtesojne ngarkesen te perdoruesi
- ✓ Nxjerrje efektive e pluhurit fale dizajnit te vecante
- ✓ Shponi me shumë vrima falë majës së dyfishtë të qendrës



SHPEJTËSIA ■■■■■■■■■■ JETËGJATËSIA ■■■■■■■■■■

Kodi	Permasa	Paketimi	Çmimi
163064	4x50x110	1	<b>250</b>
156202	5x50x110	1	<b>290</b>
176507	5x100x160	1	<b>350</b>
156226	6x50x110	1	<b>330</b>
156233	6x100x160	1	<b>350</b>
168137	6x150x210	1	<b>550</b>
156585	6x200x260	1	<b>750</b>
277877	6x250x310	1	<b>990</b>
156257	7x100x160	1	<b>390</b>
159661	8x50x110	1	<b>350</b>
156264	8x100x160	1	<b>390</b>
156271	8x150x210	1	<b>550</b>
156592	8x200x260	1	<b>790</b>
169349	8x250x310	1	<b>990</b>
156615	8x400x460	1	<b>1.450</b>
219891	8x550x600	1	<b>1.750</b>
164658	10x50x110	1	<b>450</b>
156288	10x100x160	1	<b>550</b>
156295	10x150x210	1	<b>690</b>
156301	10x200x260	1	<b>790</b>
186872	10x250x310	1	<b>990</b>
159678	10x400x460	1	<b>1.450</b>
178822	10x550x600	1	<b>1.990</b>
198820	10x950x1000	1	<b>4.900</b>
284882	10x1350x1400	1	<b>13.900</b>
156318	12x100x160	1	<b>590</b>
156325	12x150x210	1	<b>750</b>
156332	12x200x260	1	<b>850</b>
159739	12x250x310	1	<b>1.190</b>
159692	12x400x450	1	<b>1.750</b>
159708	12x550x600	1	<b>2.590</b>

Kodi	Permasa	Paketimi	Çmimi
156363	14x100x160	1	<b>890</b>
156370	14x150x200	1	<b>990</b>
156387	14x200x260	1	<b>1.190</b>
163163	14x250x300	1	<b>1.290</b>
163170	14x400x450	1	<b>1.790</b>
159715	14x550x600	1	<b>2.790</b>
198844	14x950x1000	1	<b>6.500</b>
156417	16x100x160	1	<b>1.190</b>
156424	16x150x200	1	<b>1.290</b>
169301	16x200x250	1	<b>1.390</b>
186889	16x250x300	1	<b>1.590</b>
156431	16x400x450	1	<b>1.990</b>
159722	16x550x600	1	<b>2.900</b>
198851	16x950x1000	1	<b>6.500</b>
156448	18x150x200	1	<b>1.750</b>
176569	18x200x250	1	<b>2.250</b>
186896	18x250x300	1	<b>2.350</b>
167093	18x400x450	1	<b>2.750</b>
159746	18x550x600	1	<b>3.950</b>
198868	18x950x1000	1	<b>6.900</b>
156479	20x150x200	1	<b>2.500</b>
284912	20x200x250	1	<b>2.600</b>
186902	20x250x300	1	<b>2.700</b>
156486	20x400x450	1	<b>2.990</b>
156608	20x550x600	1	<b>3.790</b>
156493	22x200x250	1	<b>3.990</b>
156509	22x400x450	1	<b>4.500</b>
236478	22x550x600	1	<b>5.900</b>
156516	24x200x250	1	<b>4.500</b>
156523	25x200x250	1	<b>4.700</b>
223409	25x250x300	1	<b>4.900</b>



# 2125 ENDURO SDS-Max

## PUNTO ENDURO SDS-Max

- ✓ Maje me performim per shpim te fuqishem.
- ✓ Jetëgjatësia më e lartë e shërbimit dhe jashtëzakonisht elastike ndaj konsumimit.
- ✓ Efektiviteti dhe shpejtësia më e lartë falë tipit Trijet plus i optimizuar me dizajnin spiral
- ✓ Përforcim çeliku dhe shpim i fuqishëm.
- ✓ Vibrimi më i ulët falë spirales e cila redukton ngarkesën tek përdoruesi.
- ✓ Transporti më i mirë i mundshëm i pluhurit të shpimit falë spiralës së trefishtë me volum të madh, me dridhje të ulët.



- Punto me 3 koka Trijet: per diameter deri 16 mm



- Punto Y-cutter: nga diametere 18 mm

SHPEJTËSIA ■■■■■■■■■■ JETËGJATËSIA ■■■■■■■■■■

### PUNTO SDS-MAX ME 3 KOKA

Kodi	Permasa	Paketimi	Çmimi
223638	18x200x340	1	<b>5.500</b>
223645	18x400x540	1	<b>5.900</b>
223652	20x200x320	1	<b>5.500</b>
223669	20x400x520	1	<b>5.900</b>
223683	22x200x320	1	<b>5.900</b>
223690	22x400x520	1	<b>6.500</b>
223713	24x200x320	1	<b>6.500</b>
223720	24x400x520	1	<b>6.900</b>
223737	25x200x320	1	<b>6.500</b>
223744	25x400x520	1	<b>6.900</b>
281966	25x600x720	1	<b>7.500</b>
223751	25x800x920	1	<b>8.900</b>
223768	25x1200x1320	1	<b>14.900</b>
223782	28x400x520	1	<b>7.500</b>
223812	30x400x520	1	<b>7.900</b>
223836	32x400x520	1	<b>8.500</b>

### PUNTO SDS-MAX ME 3 KOKA

Kodi	Permasa	Paketimi	Çmimi
223874	35x400x520	1	<b>8.900</b>
223904	38x400x520	1	<b>9.900</b>
223928	40x400x520	1	<b>11.900</b>
282017	40x600x720	1	<b>13.900</b>
223935	40x800x920	1	<b>14.900</b>
223942	40x1200x1320	1	<b>21.500</b>
233439	45x400x520	1	<b>14.900</b>
233446	50x400x520	1	<b>18.900</b>



Sds-Plus

★★	★★★	★★★	★★★
Beton Arme	Beton	Tulla Silikat	Gure
★★★	★★	★★★	★★
Tulla	Mermer	Gure Natyral	Granit



# 2211 RATIO QUICK GOTE BETONI / ADAPTOR

Gote betoni me e mira, e shpejte, e sigurte, pa ndotje

- ✓ Me dhembe te shpejte dhe thyerje ka rezultate me te mira ne llojin e vet, dhe heqjen efikase te pluhurit gjate shpimit
- ✓ Stabilitet te shkelqysem dhe jetegjatesi sherbimi
- ✓ Depertim efektiv edhe ne beton te perforcuar
- ✓ Gjatesia dhe diametri i mjetit mund te kombinohen lirshem ne sistemin e raportit



## 2211 GOTE BETONI SDS-MAX



Kodi	Permasa	Paketimi	Çmimi
233910	50x80x105	1	<b>15.900</b>
233927	65x80x105	1	<b>19.900</b>
233941	80x80x105	1	<b>21.500</b>



## 2260 ADAPTOR PUNTO SDS-MAX / SDS-PLUS

Kodi	Permasa	Paketimi	Çmimi
155472	SDS-Plus 108	1	<b>4.900</b>



✓ SHPEJTËSIA  ✓ JETËGJATËSIA

## ZGJATUES SDS-PLUS PER THYERJE BETON ARME



Kodi	Permasa	Paketimi	Çmimi
299039	14x300	1	<b>1.900</b>

## 2281 ZGJATUES PER SISTEMIN RATIO SDS-MAX



Kodi	Permasa	Paketimi	Çmimi
102315	25x280x320	1	<b>9.900</b>



## 2206 ADAPTOR PUNTO QENDRE



Kodi	Permasa	Paketimi	Çmimi
102308	12x155	1	<b>3.500</b>



# 3226 / 3215 / 3270 GOTE BETONI SDS-PLUS

## GOTE BETONI SDS-PLUS



- ✓ E fuqishme, e shpejte, e durueshme, me punto qendre
- ✓ Perqendrim i sakte per shpime precize dhe pune te pershtatshme.
- ✓ Karakteristike vecanerisht e mire ne saje te trupit prej celiku te temperuar

### 3215 / 18 GOTE KOMPLET PER SISTEM SDS-PLUS



Kodi	Permasa	Paketimi	Çmimi
196253	40x50x120	3	<b>7.500</b>
196260	50x50x120	3	<b>7.900</b>
233422	68x50x120	3	<b>7.900</b>
189484	90x50x120 (jo set)	3	<b>5.900</b>

### 3226 PUNTO QENDRE PER GOTE BETONI



Kodi	Permasa	Paketimi	Çmimi
189514	9x120	1	<b>390</b>

### PUNTO GOTE PROFI PLLAKASH DHE PORCELANI



Kodi	Permasa	Paketimi	Çmimi
296168	6x67	1	<b>2.890</b>
296175	8x67	1	<b>2.990</b>
296182	10x80	1	<b>3.550</b>
296205	12x80	1	<b>3.990</b>

### 3270 / 18 ZGJATUES PER SISTEM SDS-PLUS



Kodi	Permasa	Paketimi	Çmimi
189552	300 mm	1	<b>2.250</b>



## 2011 SDS-Plus DALTE SDS-Plus

Shpon lehte edhe vendet me te veshtira

- ✓ Produkt i duhur per cdo pune me dalte.
- ✓ Dizanji i optimizuar rrit fuqine, performancen dhe qendrueshmerine e daltes.
- ✓ Fuqia e transmetuar e permiresuar fale gjatesise se daltes
- ✓ Dalte ideale pa humbje te forces goditese
- ✓ Jetegjatesi sherbimi fale celikut special

SHPEJTËSIA  JETËGJATËSIA

### DALTE SDS-PLUS / ME MAJE / TE SHESHTE / TE GJERE

Kodi	Pershkrimi	Permasa	Çmimi
196208	Dalte SDS-Plus me maje	250	<b>990</b>
196215	Dalte SDS-Plus e sheshte	20x250	<b>990</b>
196222	Dalte SDS-Plus e gjere	40x250	<b>1.590</b>



#### DALTE SDS-PLUS ENDURO

Kodi	Pershkrimi	Permasa	Çmimi
285421	Dalte SDS-Plus me maje	250	<b>1.150</b>
285438	Dalte SDS-Plus e sheshte	20x250	<b>1.150</b>
285445	Dalte SDS-Plus e gjere	40x250	<b>1.990</b>



## 2511 SDS-Max DALTE SDS-Max

Per punet me te veshtira



### DALTE SDS-MAX / ME MAJE / TE SHESHTE / TE GJERE

Kodi	Pershkrimi	Permasa	Çmimi
210003	SDS-MAX me maje	280	<b>990</b>
210010	SDS-MAX me maje	400	<b>1.250</b>
210034	SDS-MAX te sheshte	25x280	<b>990</b>
210041	SDS-MAX te sheshte	25x400	<b>1.250</b>
210065	SDS-MAX te sheshte	50x400	<b>1.990</b>
540072	SDS-MAX te gjere	75x300	<b>2.990</b>

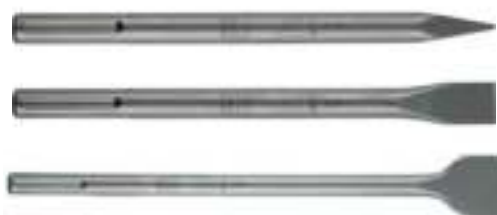

#### DALTE SDS-MAX ENDURO

Kodi	Pershkrimi	Permasa	Çmimi
285452	Dalte SDS-Max me maje	350	<b>1.750</b>
285469	Dalte SDS-Max e sheshte	25x250	<b>1.750</b>
285476	Dalte SDS-Max e sheshte	50x350	<b>2.990</b>



## 3750 PROXTREME PUNTO BETONI DHE GRANITI

Puntot tona me te mira per kerkesa extreme ne beton dhe ne gure natyral

- ✓ E fuqishme, e qendrueshme, e pershtatshme. Performance superiore ne beton dhe ne te gjitha llojet e gureve natyrale.
- ✓ Krah me 3 kende parandalon rreshqitjen dhe shkeputjen gjate perdorimit
- ✓ Nje game e gjere aplikacionesh dhe perqendrim te persosur
- ✓ Projektuar posacerisht per shpime te veshtira si: Beton, granit, mermer, gure natyrore etj.
- ✓ Shpejtesi jashtezakonisht e larte ne saje te gjeometrise me dizanj te optimizuar te helikes gjate volumit te madh.

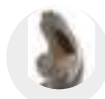

SHPEJTËSIA  JETËGJATËSIA

Kodi	Permasa	Paketimi	Çmimi
282475	5x50x115	1	<b>490</b>
2820505	6x110	1	<b>590</b>
282499	6x60x125	1	<b>650</b>

Kodi	Permasa	Paketimi	Çmimi
282505	6x110x175	1	<b>690</b>
282536	8x80x145	1	<b>790</b>
282550	10x80x145	1	<b>890</b>
282567	12x90x150	1	<b>890</b>

## 3000 PROCONCRETE PUNTO BETONI

Punto cilesore per zgjidhje profesionale shpimi

- ✓ Cilesi e qendrueshme extreme e puntove me jetegjatesi me te larte krahasuar me puntot e betonit tradicionale
- ✓ E krijuar per perdorim te vazhdueshem ne beton dhe gure
- ✓ Jetegjatesi sherbimi fale gjeometrise se optimizuar te orbitit me kende

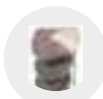

SHPEJTËSIA  JETËGJATËSIA

Kodi	Permasa	Paketimi	Çmimi
100014	4x85 mm	1	<b>250</b>
100038	5x90 mm	1	<b>290</b>
100274	6x150 mm	1	<b>350</b>
100083	8x120 mm	1	<b>350</b>

Kodi	Permasa	Paketimi	Çmimi
100281	8x200 mm	1	<b>490</b>
100113	10x120 mm	1	<b>390</b>
100298	10x200 mm	1	<b>490</b>
100137	12x130 mm	1	<b>490</b>
100151	14x150 mm	1	<b>650</b>





# 3870 DISK DIAMANTI UNIVERSAL PRO PLUS

Disqe prerës universal me performance të lartë prerje



- ✓ Prerje të shpejta dhe të pastra edhe në beton armë
- ✓ Segmente të veçanta të dhembeve të salduara me lazer për reduktimin e nxehtësisë
- ✓ E përshtatshme për prerje në te thate e te lagësht
- ✓ Vrima ftohje për të reduktuar vibracionin dhe ftohjen optimale
- ✓ Te përshtatshme për gure fleksibel dhe prerese betoni



Kodi				Çmimi
315272	115	22.23	12	<b>2.500</b>
315289	125	22.23	12	<b>2.900</b>
315302	230	22.23	15	<b>5.500</b>
315319	300	30	15	<b>6.900</b>
315326	300	25.4	15	<b>6.900</b>
315333	350	20	15	<b>7.900</b>
315340	350	25.4	15	<b>7.900</b>
315357	400	20	15	<b>9.900</b>
315364	400	25.4	15	<b>9.900</b>

## GURE PRERËS INOXI SUPERIOR CUT



Kodi				Çmimi
314206	115	22.23	1.0	<b>120</b>
314220	125	22.23	1.0	<b>130</b>
314251	180	22.23	1.5	<b>290</b>
314268	230	22.23	1.9	<b>350</b>

## GURE PRERËS INOXI SUPERIOR PRO



Kodi				Çmimi
314275	115	22.23	1.0	<b>100</b>
314299	125	22.23	1.0	<b>110</b>





Ekskluzive në

**BAUMARKET**

**TELWIN®**

**MADE IN ITALY**



**KONSUMATORE**

**PROFESIONAL**

**INDUSTRIA**

**AUTOMOTIVI**

**TELWIN - MARKA NR.1 NË SEKTORIN E SALDIMIT**

Qe nga viti 1963, Telwin ka qene nje pike reference ne lidhje me saldimit, spot welding, prerjen me plazem, karikimin dhe starterat e makinave. Telwin i pranishem ne 5 kontinente, me shperndarje te fuqishme garanton besueshmeri dhe sherbim profesional. Telwin do te thote shpejtesi, perpikmeri, efikasitet: duke u ofruar klienteve te saj garanci absolute. Telwin do te thote keshilla, ndihme dhe informacion nepermjet laboratorit te trajnimit Telwin. Protagoniste per ekselence per te gjitha aktivitetet trajnuese. Telwin ka gamen me te gjere, me te plote ne te gjitha tregun.



**816124** Saldatrice inverter MMA 170 INFINITY, me aksesore

**816129** Saldatrice inverter MMA 200 INFINITY, me aksesore



Te dhena	CODE	V <sub>1PH</sub>	A <sub>MIN</sub> 40°C DC	A <sub>MAX</sub> 40°C DC	P <sub>MAX</sub>	P <sub>MIN</sub> GEN	Ø <sub>MIN</sub> MAX DC	Çmimi
		v	A	EN 60974-1 A	kw	kw	mm	
INFINITY 170 230V ACX	<b>816124</b>	230 1ph	20÷150	140 25%	4.5	6	1.6 4	29.900
INFINITY 200 230V ACX	<b>816129</b>	230 1ph	10÷200	180 20%	5.6	8	1.6 4	39.900



**816023** Saldatrice inverter MMA Tecnica 188MPGE, per gjenerator, me aksesore



Te dhena	CODE	V <sub>1PH</sub>	A <sub>MIN</sub> A <sub>MAX</sub> DC	A <sub>MAX</sub> 40°C DC EN 60974-1 A	P <sub>MAX</sub>	P <sub>MIN</sub> GEN	Ø <sub>MIN</sub> Ø <sub>MAX</sub> DC	Çmimi
		V	A	A	kW	kW	mm	
TECNICA 188 MPGE	<b>816023</b>	230 1ph	10÷150	140 25%	4.2	6	1,6 4	<b>39.900</b>

**816152** Saldatrice inverter MMA Tecnica 238XT CE/MPGE, per gjenerator dhe alumin



Aluminium

Te dhena	CODE	V <sub>1PH</sub>	A <sub>MIN</sub> A <sub>MAX</sub> DC	A <sub>MAX</sub> 40°C DC EN 60974-1 A	P <sub>MAX</sub>	P <sub>MIN</sub> GEN	Ø <sub>MIN</sub> Ø <sub>MAX</sub> DC	Çmimi
		V	A	A	kW	kW	mm	
TECH- NOLOGY	<b>816152</b>	230 1ph	5÷200	200 35%	6.3	10	1,6 4	<b>59.900</b>

**816181** Saldatrice inverter MMA Linear 350i, 270A trefazore, profesionale



Te dhena	CODE	V <sub>3PH</sub>	A <sub>MIN</sub> A <sub>MAX</sub> DC	A <sub>MAX</sub> 40°C DC EN 60974-1 A	P <sub>MAX</sub>	P <sub>MIN</sub> GEN	Ø <sub>MIN</sub> Ø <sub>MAX</sub> DC	Çmimi
		V	A	A	kW	kW	mm	
LINEAR 350i	<b>816181</b>	230/400 3ph	20-270	270 40%	9	13	1,6 6	<b>159.000</b>

**816087** Saldatrice MIG/MAG Maxima 200 Synergic, me aksesore

**816234** Saldatrice MIG/MAG Maxima 230 Synergic, me aksesore



Te dhena	CODE	V <sub>1PH</sub>	A <sub>MIN</sub> A <sub>MAX</sub> DC	A <sub>MAX</sub> 40°C DC EN 60974-1 A	P <sub>MAX</sub>	Ø <sub>ST</sub>	Ø <sub>MIN</sub> Ø <sub>MAX</sub> DC	Çmimi
		V	A	A	kW	mm	mm	
MAXIMA 200	<b>816087</b>	230 1ph	20÷170	140 20%	3.2	0,6 0,8	1,6 3,2	<b>89.000</b>
MAXIMA 230	<b>816234</b>	230 1ph	20÷220	180 20%	5.0	0,6 1,0	1,6 3,2	<b>99.000</b>

**816196** Saldatrice MIG-MAG/MMA/TIG DC, Mastermig 275i, trefazore, me aksesore

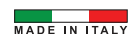

**816197** Saldatrice MIG-MAG/MMA/TIG DC, Mastermig 405i, trefazore, me aksesore



Te dhena	CODE	V <sub>3PH</sub>	A <sub>MIN</sub> A <sub>MAX</sub> DC	A <sub>MAX</sub> 40°C DC EN 60974-1 A	P <sub>MAX</sub>	Ø <sub>ST</sub>	Ø <sub>MIN</sub> Ø <sub>MAX</sub> DC	Çmimi
		V	A	A	kW	mm	mm	
MASTERMIG 275i	<b>816196</b>	400 3ph	20÷250	270 40%	8.8	0,6 1,2	1,6 5	<b>195.000</b>
MASTERMIG 405i	<b>816197</b>	230/400 3ph	20÷400	400 40%	16	0,6 1,6	1,6 8	<b>299.000</b>

**852055** Saldatrice TIG, Technology 230 DC, me aksesore  
**816244** Saldatrice TIG, Technology 202 AD/DC, per alumin, me aksesore

MADE IN ITALY

Aluminium **MIX**  
AC-DC



Te dhena	CODE	V <sub>1PH</sub>	A <sub>MIN</sub> MAX DC	A <sub>MAX</sub> 40°C DC EN 60974-1 A	P <sub>MAX</sub>	P <sub>60%</sub>	Ø <sub>MIN</sub> MAX DC	Çmimi
		V	A	A	KW	KW	mm	
TIG 230 DC	<b>852055</b>	230 1ph	10÷220	220 30%	6	4.1	1.6 4	<b>195.000</b>
TIG 202 AC/DC	<b>816244</b>	230 1ph	5÷180	180 20%	5.5	3.3	1.6 4	<b>245.000</b>

**816145** Saldatrice Plasma Infinity 40A, prerje 15mm/Max, me aksesore

MADE IN ITALY



Te dhena	CODE	V <sub>1PH</sub>	A <sub>MIN</sub> MAX DC	A <sub>MAX</sub> 40°C DC EN 60974-1 A	P <sub>MAX</sub>	Ø	Çmimi
		V	A	A	KW	mm	
PLASMA 40	<b>816145</b>	230 1ph	10-40	40 20%	4	15	<b>89.500</b>

**816148** Saldatrice Plasma Technology 60A, prerje 20mm/Max, me aksesore

MADE IN ITALY



Te dhena	CODE	V <sub>1PH</sub>	A <sub>MIN</sub> MAX DC	A <sub>MAX</sub> 40°C DC EN 60974-1 A	P <sub>MAX</sub>	Ø	Çmimi
		V	A	A	KW	mm	
PLASMA 60 XT	<b>816148</b>	230 1ph	10-60	50 30%	5.5	20	<b>139.000</b>

**807544** Karikues baterie Alpine 15, 0.1Kw, 9-115/12V, 4.5-40/24V  
**807545** Karikues baterie & boost Alpine 18, 0.2Kw, 14-185/12V, 6-90/24V  
**807547** Karikues baterie & boost Alpine 30, 0.8Kw, 30-400-12/24V  
**807548** Karikues baterie & boost Alpine 50, 1Kw, 45-500-12/24V

MADE IN ITALY



Te dhena	CODE	V <sub>1PH</sub>	P	V	A <sub>EFF</sub>	Ah <sub>MIN</sub>	Ah <sub>MAX</sub>	Çmimi
		V	W	V	A	Ah	Ah	
ALPINE 15	<b>807544</b>	230 1ph	110	12/24	9/4.5	60/30	115/40	<b>14.900</b>
ALPINE 18 BOOST	<b>807545</b>	230 1ph	200	12/24	14/8	14/6	185/90	<b>16.900</b>
ALPINE 30 BOOST	<b>807547</b>	230 1ph	800	12/24	30	15	400	<b>29.500</b>
ALPINE 50 BOOST	<b>807548</b>	230 1ph	1000	12/24	45	20	500	<b>39.000</b>

**829381** Karikues dhe starter Dynamic 320, 12-24V, 1-6.4Kw, 700Ah

MADE IN ITALY

**829382** Karikues dhe starter Dynamic 420, 12-24V, 1.6-10Kw, 1000Ah

**829383** Karikues dhe starter Dynamic 520, 12-24V, 1.6-10Kw, 1000Ah

**829384** Karikues dhe starter Dynamic 620, 12-24V, 2-10Kw, 1550Ah



🔌 | 🔌 | 🔌 | 🔌 | 🔌 | 🔌 | 🔌

Te dhena	CODE	V <sub>1PH</sub>	P <sub>CHARGE</sub>	P <sub>START</sub>	V	Ah <sub>MIN</sub>	Ah <sub>MAX</sub>	Çmimi
		V	KW	KW	V	Ah	Ah	
DYNAMIC 320 START 230V 12-24V	<b>829381</b>	230 1ph	1	6.4	12 / 24	20	700	<b>49.000</b>
DYNAMIC 420 START 230V 12-24V	<b>829382</b>	230 1ph	2	12	12 / 24	20	1000	<b>59.000</b>
DYNAMIC 520 START 230V 12-24V	<b>829383</b>	230 1ph	2	12	12 / 24	20	1000	<b>69.000</b>
DYNAMIC 620 START 230V 12-24V	<b>829384</b>	230 1ph	2	12	12 / 24	20	1550	<b>79.000</b>

**MASKE SALDIMI**
**MMA/MIG-MAG/TIG**

Kodi	Të dhena	Çmimi
802818	me hapje, 11DIN	4.500

**MASKE SALDIMI**
**MMA/MIG-MAG/TIG**

**AUTOMATIK**

Kodi	Të dhena	Çmimi
804151	automatike Lion, 11DIN	4.900

**MASKE SALDIMI**
**MMA/MIG-MAG/TIG**

 Automatike Stream Flame  
me 2 sensore 9-13DIN

Kodi	Të dhena	Çmimi
804235	95x115mm	7.500

**MASKE SALDIMI**
**MMA/MIG-MAG/TIG**

Automatike Jaguar me 4 sensore



Kodi	Të dhena	Çmimi
804081	4-13DIN, 114x134mm	9.900

**TEL ARGONI**
**MIG-MAG**

Kodi	Të dhena	Çmimi
802133	Celik, 0.8mm/0.8Kg	1.590
802051	Inoxi, 0.8mm/0.5Kg	4.990

**TEL ARGONI**
**MIG-MAG**

Kodi	Të dhena	Çmimi
802062	Alumini, 0.8mm/0.45Kg	4.500
802064	Alumini, 1.0mm/0.45Kg	4.500

**PINCE MASE**
**DALLAS**

Kodi	Të dhena	Çmimi
802769	300A	850
802770	400A	990
802785	600A	2.990

**PINCE MASE**
**TOLEDO**

Kodi	Të dhena	Çmimi
804181	250A	490
804182	300A	590
804183	400A	1.590
804184	600A	2.590

**PINCA KONTAKTI BATERIE**
**COLORADO**

Kodi	Të dhena	Çmimi
802531	150A / e kuqe	550
802532	150A / e zeze	550

**KIT SALDIMI MMA**
**MMA**

Kodi	Të dhena	Çmimi
801102	250A,25mm / 3+2M AX25	11.900
801081	300A,25mm / 4+3M AX50	17.500
801095	350A,35mm / 4+3M AX50	19.900
801093	400A,50mm / 4+3M AX50	24.500

**PRIZE SALDIMI F**
**ATLAS**

Kodi	Të dhena	Çmimi
804196	DX25mm	450
804197	DX50mm	850

**SPINOTE SALDIMI M**
**ATLAS**

Kodi	Të dhena	Çmimi
804199	DX25mm	450
804200	DX50mm	950



**TORCE SALDIMI**
**MIG**

Kodi	Të dhena	Çmimi
742901	MIG 160A, 2m, 150A	8.500

**TORCE SALDIMI**
**MIG**

Kodi	Të dhena	Çmimi
742180	MIG MT15, 3m, 220A	11.500
742181	MIG MT15, 4m, 220A	12.500
742183	MIG MT25, 3m, 220A	14.500
742184	MIG MT25, 4m, 350A	16.900

**TORCE SALDIMI**
**MIG**

Kodi	Të dhena	Çmimi
742185	MIG MT25, 5m, 350A	19.900
742186	MIG MT36, 3m, 500A	25.900
742187	MIG MT36, 4m, 500A	29.000
742188	MIG MT36, 5m, 500A	33.000

**BEK KONIK**
**MT**

Kodi	Të dhena	Çmimi
722423	I vogel MT15	450
722685	I mesem MT25	790
722792	I madh MT36	1.990

**QAFE TORCE**

Kodi	Të dhena	Çmimi
722078	TW160-180/ 170A me difuzor	1.690
722305	MT15 / 220A	2.500
722696	MT25 / 350A	3.300
722788	MT356/ 500A	4.990

**MAJE CELIKU**
**M**

Kodi	Të dhena	Çmimi
722416	M6/ 0.8mm MT15	220
722705	M6/ 1.0mm MT15	250
722680	M6/ 0.8mm MT25	290
722681	M6/ 1.0mm L28mm MT25	330
722582	M8/ 1.0mm MT36	490
722682	M8/ 1.2mm MT36	350
722797	M8/ 1.6mm MT36/40	390

**MAJE ALUMINI**
**M**

Kodi	Të dhena	Çmimi
722556	M6/ 0.8mm MT15/25	330
722552	M6/ 1.0mm MT15/25	350
722553	M6/ 1.2mm MT15/25	390

**MBAJTESE MAJE TELI**
**M**

Kodi	Të dhena	Çmimi
722688	M6 / MT25	590
722789	M8/ MT36	690
722807	M8 / MT40	1.990

**DIFUZOR GAZI / IZOLATOR**

Kodi	Të dhena	Çmimi
722791	MT36	490

**SUSTE TORCE**

Kodi	Të dhena	Çmimi
722319	e vogel	250
722690	e madhe	350

**GUAJNE TELI**

Kodi	Të dhena	Çmimi
722712	celiku Ø0.6-0.8 5M Blu	2.900
722766	celiku Ø1.0-1.2 5M Kuqe	3.500
722516	alumini Ø1.0-1.2 3 M	4.900

**RRUL TELI**

Kodi	Të dhena	Çmimi
722529	celiku 0.6-0.8mm	490
722019	celiku 0.8-0.9mm	490
722227	celiku 0.8-0.1mm	2.900
742054	celiku 1.0-1.2mm	1.990
742090	alumini 0.8-1.0mm	3.300
722167	alumini 1.0-1.2mm	2.990

**REDUKTOR GAZI**
**ARGONI**

Kodi	Të dhena	Çmimi
722119	e vogel	8.500
722346	e madhe	14.500

**TORCE SALDIMI**
**TIG**

Kodi	Të dhena	Çmimi
801097	200A DX25	29.000
804362	250A DX50	35.900
802788	350A DX50	39.900

**KAPUC I GJATE**
**TIG**

Kodi	Të dhena	Çmimi
722981	e vogel	950
722193	e madhe	2.500

**BEK QERAMIK PER TORCA**
**TIG**

Kodi	Të dhena	Çmimi
802229	TIG Nr.4 e shkurter ST9	950
802230	TIG Nr.5 e shkurter ST9	950
802231	TIG Nr.6 e shkurter ST9	950
802244	TIG Nr.4 e gjate SR17-26	1.590
802245	TIG Nr.5 e gjate SR17-26	1.590
802246	TIG Nr.6 e gjate SR17-26	1.590

**MBAJTESE ELEKTRODE**
**TIG**

Kodi	Të dhena	Çmimi
802223	Tungsteni, 1.0mm AC	450
802225	Tungsteni, 1.6mm AC	450
802239	Tungsteni, 1.0mm AC/DC	550
802240	Tungsteni, 1.6mm AC/DC	590
802241	Tungsteni, 2.4mm AC/DC	590
802242	Tungsteni, 3.2mm AC/DC	590

**DIFUZOR**
**TIG**

Kodi	Të dhena	Çmimi
802226	1.0mm AC	890
802249	1.0mm AC/DC	1.290
802250	1.6mm AC/DC	1.290
802251	2.4mm AC/DC	1.290
802252	3.2mm AC/DC	1.290
802253	4.0mm AC/DC	1.290

**ELEKTRODA TUNGSTENI PURO OSE TE VESHURA AC/DC**
**TIG**

Kodi	Të dhena	Çmimi
802235	AC	3.900
802236	AC	7.900
802237	AC	13.500
802222	DC	3.900
802232	DC	7.900
802233	DC	13.500

**KAPAC TORCE**

Kodi	Të dhena	Çmimi
802096	20A	7.500
802093	40A	6.500
802425	60A	4.500
802081	80A	3.500
802126	90A	8.500

**DIFUZOR PLAZMA**
**PLAZMA**

Kodi	Të dhena	Çmimi
802422	41	7.500
802080	60	3.500
802123	90	6.990

**ELEKTRODA PER TORCE**
**PLAZMA**

Kodi	Të dhena	Çmimi
802420	te shkurtra 20A	2.200
802076	te shkurtra 20A	2.200
802122	te shkurtra 20A	2.500
802428	te gjata 40A	2.900
802078	te gjata 60A	2.900
802082	te gjata 90A	4.500

**HUNDEZA PER TORCE**
**PLAZMA**

Kodi	Të dhena	Çmimi
802092	te shkurtra 20A	2.500
802423	te shkurtra 40A	2.690
802077	te shkurtra 60A	1.690
802124	te shkurtra 90A	2.500
802119	te shkurtra 120A	2.500
802429	te gjata 40A	3.900
802079	te gjata 60A	2.500
802083	te gjata 90A	8.500

**TORCE PLAZMA**
**PLAZMA**

Kodi	Të dhena	Çmimi
742237	4M 40A	39.900
742040	6M 60A	49.000
722474	6M 80A	39.000

 **airmec**  
AIR COMPRESSOR

  
MADE IN ITALY

Power  
Line



**Ekskluzive në**

**BAUMARKET**





Çmimi  
**17.500**

STRATOS 24L



Çmimi  
**19.900**

STRATOS 50L

### Kompresor monofaze STRATOS 24L / 50L

Kodi	lt.	Type	l/min	kW	hp	Volt	r.p.m.	n°	stage n°	bar	p.s.i.	kg	L x B x H			LwA
<b>1129990382</b>	24	TH 25	150	1,5	2	230	2850	2	1	8	145	20	580	330	650	95
<b>1129990384</b>	50	TH 25	170	1,5	2	230	2850	2	1	8	145	32	630	370	760	97

Power  
Line



MADE IN ITALY

Çmimi  
**59.900**  
CRM 100-2 PL

### Kompresor monofaze AirMec 100L

Kodi	lt.	Type	l/min	kW	hp	Volt	r.p.m.	n°	stage n°	bar	p.s.i.	kg	L x B x H			LwA
<b>141940101</b>	100	TH 25	235	1,5	2	230	740	2	1	10	145	62	990	400	760	95

# Power Line

 MADE I N ITALY  

**Çmimi**
**95.000**

CRM 200-3 PL

**Çmimi**
**99.000**

CRT 200-3 PL

**Kompresor monofaze/trefazor AirMec 200L**

Modeli	lt.	Type	l/min	kW		Volt	r.p.m.	n°	stage n°	bar	p.s.i.	kg	L x B x H			LwA
				hp	hp											
<b>141940200</b>	200	TH 25	320	2,2	3	230	1025	2	1	10	145	98	1460	500	930	95
<b>141940230</b>	200	TH 25	320	2,2	3	400	1025	2	1	10	145	97.5	1460	500	930	95

 MADE I N ITALY  



# Power Line

**Çmimi**
**125.000**

CRT 300-4 PL

**Kompresor monofaze AirMec 300L**

Modeli	lt.	Type	l/min	kW		Volt	r.p.m.	n°	stage n°	bar	p.s.i.	kg	L x B x H			LwA
				hp	hp											
<b>141940300</b>	300	TH 25	350	3	4	400	1120	2	1	10	145	124	1590	570	1180	97

MADE I N ITALY



Power Line

Çmimi

**199.000**

CFT 500-5,5 PL

Çmimi

**225.000**

CFT 500-7,5 PL

Kompresor trefazor AirMec 500L

Modeli	lt.	Type	l/min	kW	hp	Volt	r.p.m.	n°	stage n°	bar	p.s.i.	kg	L x B x H			LwA
<b>141940700</b>	500	NB 5	582	4	5,5	400	1370	2	2	10	145	209	2090	730	1310	97
<b>141940800</b>	500	NB 7	860	5,5	7,5	400	1215	2	2	10	145	219	2090	730	1310	97

MADE I N ITALY



Çmimi

**359.000**

CFT 500 2x5,5 PL

Çmimi

**395.000**

CFT 500 2x7,5 PL

Kompresor trefazor me 2 motorra AirMec 500L

Modeli	lt.	Type	l/min	kW	hp	Volt	r.p.m.	n°	stage n°	bar	p.s.i.	kg	L x B x H			LwA
<b>141941100</b>	500	NB 5x2	582x2	4x2	5,5x2	400	1350	2	2	10	145	271	2090	730	1310	97
<b>141941200</b>	500	NB 5x2	860x2	5,5x2	7,5x2	400	1215	2	2	10	145	283	2090	730	1310	97



# Power Line

 MADE I N ITALY  

Grup kompresori AirMec 100L-200L-300L, TH25, 306l/min, 1000rpm



Kodi	cm3	l/min	r.p.m.
<b>TH 25</b>	<b>306</b>	<b>306</b>	<b>1000</b>

Çmimi

**25.900**

Grup kompresori AirMec 300L, NB4, 329l/min, 1000rpm

 MADE I N ITALY  

Kodi	cm3	l/min	r.p.m.
<b>NB 4</b>	<b>329</b>	<b>329</b>	<b>1000</b>

Çmimi

**49.900**

Grup kompresori AirMec 300L-500L, NB5, 425l/min, 1000rpm

 MADE I N ITALY  

Kodi	cm3	l/min	r.p.m.
<b>NB 5</b>	<b>425</b>	<b>425</b>	<b>1000</b>

Çmimi

**69.900**

Grup kompresori AirMec 500L, NB7, 675l/min, 1000rpm

 MADE I N ITALY  

Kodi	cm3	l/min	r.p.m.
<b>NB 7</b>	<b>675</b>	<b>675</b>	<b>1000</b>

Çmimi

**99.000**

**KOMPRESOR AJRI PA VAJ**

**15.900**
**KOMPRESOR AJRI SILENCIOZ PA VAJ 24 LT**

<b>Kodi</b>	<b>APS24</b>
Depozita	24 L
Fuqia	2 HP / 230 V
Presioni	7 Bar

**KOMPRESOR AJRI PA VAJ**

**19.900**
**KOMPRESOR AJRI SILENCIOZ PA VAJ 50 LT**

<b>Kodi</b>	<b>APS50</b>
Depozita	50 L
Fuqia	2 HP / 230 V
Presioni	7 Bar

**KOMPRESOR AJRI ME VAJ**

**14.900**
**KOMPRESOR AJRI 24 LT**

<b>Kodi</b>	<b>AP24</b>
Depozita	24 LT
Fuqia	2 HP / 230 V
Presioni	8 Bar

**KOMPRESOR AJRI ME VAJ**

**16.900**
**KOMPRESOR AJRI 50 LT**

<b>Kodi</b>	<b>AP50</b>
Depozita	50 LT
Fuqia	2 HP / 230 V
Presioni	8 Bar

**43.900**
**KOMPRESOR AJRI 100 LT**

<b>Kodi</b>	<b>AP100</b>
Depozita	100 LT
Fuqia	2 HP / 230 V
Presioni	8 Bar

**44.500**
**KOMPRESOR AJRI DOPIO PISTON 100 LT**

<b>Kodi</b>	<b>APV100</b>
Depozita	100 LT
Fuqia	3 HP / 230 V / 50 HZ
Presioni	8 Bar

**KOMPRESOR AJRI ME VAJ**

**69.000**
**KOMPRESOR AJRI 200 LT**

Kodi	AP200
Depozita	200 LT
Fuqia	4 HP / 380 V
Presioni	10 Bar

**GRUP KOMPRESORI**

**GRUP KOMPRESORI**

Kodi	Per kompresor	Cmimi
FOG2450	24 / 50 L	<b>11.500</b>

**GRUP KOMPRESORI**

**GRUP KOMPRESORI**

Kodi	Per kompresor	Cmimi
FOG100	100 L	<b>12.900</b>

**GRUP KOMPRESORI**

**GRUP KOMPRESORI**

Kodi	Per kompresor	Cmimi
FOG200	200 L	<b>14.900</b>

**ELEKTROMOTOR KOMPRESORI**

**ELEKTROMOTOR KOMPRESORI**

Kodi	Fuqia	Cmimi
FOM100	2 Hp	<b>9.900</b>

**GRUP KOMPRESORI**

**GRUP KOMPRESORI**

Kodi	Fuqia	Cmimi
FOM200	3 Hp	<b>18.900</b>



## Tronkatrice me syprine 733 tavoline motorr me induksion



WATT	RPM	mm	mm	Kg	mm	mm
1300	2850	D254 - d30	530x535x390	17,5	h max 75	L max 162

Kodi	Çmimi
8.42.00.29	55.000

- Fuqia 1300W
- Nr i rrotullimeve 2850rpm
- Diametri Ø 254mm,
- Kendi 0-47grade,
- Tavolina 360x462 mm,
- motorri me induksion

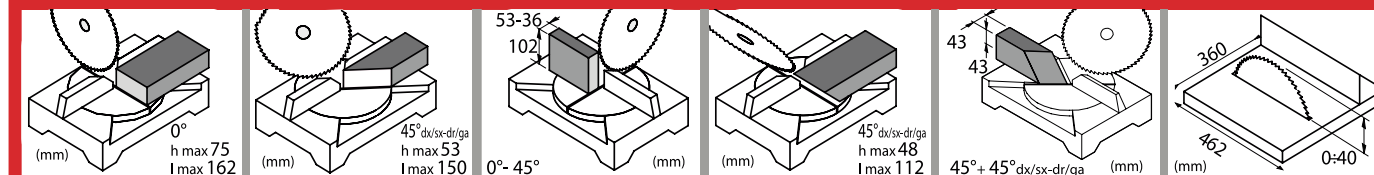

## Tronkatrice me syprine 733 tavoline motorr me induksion



WATT	RPM	mm	mm	Kg	mm	mm
1400	3000	D305 - d30	640x640x510	29	h 78	L 170

Kodi	Çmimi
8.43.80.22	79.000

- Fuqia 1400W
- Nr i rrotullimeve 3000rpm
- Diametri Ø 305 mm,
- Kendi 0-45grade,
- Tavolina 475 x 325 mm,
- motorri me induksion

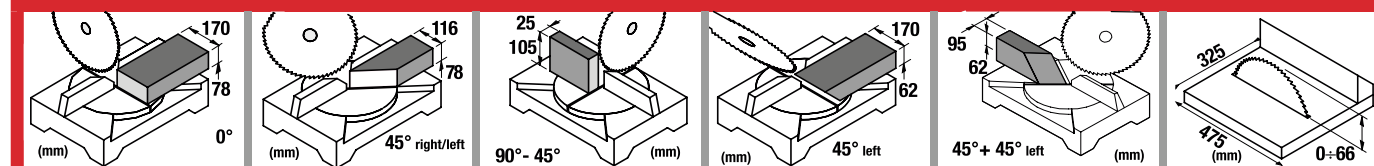

## Tronkatrice me syprine per alumin XXX EVO 3 pozicione



WATT	RPM	D305-d30	a x b x h mm	Kg	70 mm
1500	2850	D305-d30	630x630x500	21,5	← 170 mm →

Kodi	Çmimi
8.43.60.46	95.000

- Fuqia 1500W
- Nr i rrotullimeve 2850rpm
- Diametri Ø 305mm,
- Kendi 0-47grade,
- Tavolina 475 x 325 mm,
- 3 Pozicione

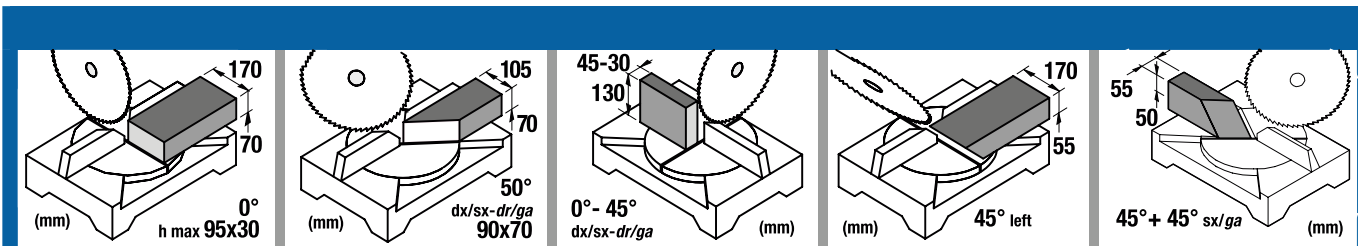

## Strukture mbajtese alumini per tronkatrice me syprine MULTY 360

- Lartesia 630 - 830 mm
- Priza korendi 3
- Pesha max 120 kg



Kodi	Çmimi
7.13.36.47	39.500

## Baze mbeshtetese celiku teke me lartesi te rregullueshme

- Permasa 520x400x680 mm
- Diametri Ø 57 mm,
- Pesha max 30 kg

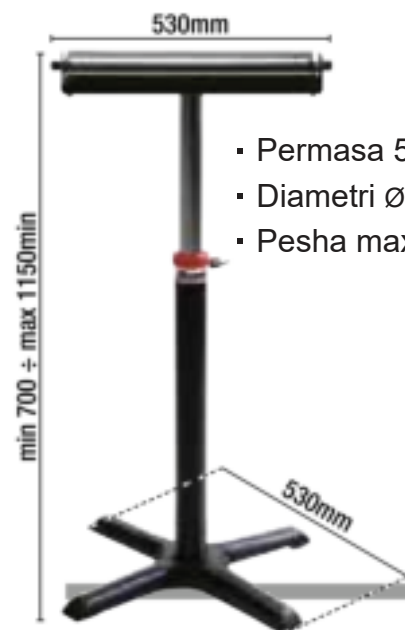

Kodi	Çmimi
7.13.37.16	14.900

## Sharre hekuri bango 780XL

850	1335x13x0,65	8/12*	60/80	730x390x500	17



Kodi	Çmimi
8.48.33.21	65.000

- Fuqia 850W
- Rrip 1335x13x0.65mm
- Diametri  $\varnothing$  105 mm,
- Kendi 0-45 grade



0°	105x93 mm	105 mm	102x102 mm
45°	70x60 mm	72 mm	68x68 mm



## Sharre hekuri bango 784XL

1200	1440x13x0,65	8/12*	30 ÷ 80	900x400x520	17



Kodi	Çmimi
8.48.50.23	75.000

- Fuqia 1200W
- Rrip 1440x13x0.65mm
- Diametri  $\varnothing$  120 mm,
- Kendi 0-45 grade



0°	120x115 mm	120 mm	119x119 mm
45°	85x70 mm	85 mm	80x80 mm





## Sharre hekuri bango 785XL



WATT	mm	Z/1°	M/0mm	a x b x h mm	Kg
1600	1735x13x0,9	14°	60/80	1000x390x570	38

Kodi	Çmimi
8.48.60.26	99.000

- Fuqia 1600W
- Rip 1735x13x0.9mm
- Diametri Ø 152 mm,
- Kendi 0-45 grade



0°	205x150 mm	152 mm	150x150 mm
45°	105x95 mm	106 mm	102x102 mm



### Lame sharre hekuri per 784XL, 1440x13x0.65mm 8/12\* (1 cope)



Kodi	Çmimi
3.28.99.48	4.990



### Lame sharre hekuri per 780XL, 1335x13x0.65mm 8/12\* (1 cope)



Kodi	Çmimi
3.29.00.00	4.990



### Lame sharre hekuri per 785XL, 1735x13x0.9mm 14\* (1 cope)



Kodi	Çmimi
3.28.99.25	5.500



Ekskluzive në

**BAUMARKET**

SET VALIXHE C BLOCK ME  
DOREZE ALUMINI 2 NE 1



Kodi	Dimensionet	Çmimi
KXCS454055	450X380X545 MM	<b>13.500</b>

SET VALIXHE COMPACT BLOCK  
3 NE 1



Kodi	Dimensionet	Çmimi
KXCS454080	450X380X800MM	<b>14.500</b>

VALIXHE VEGLASH VAGON ME KAPESE  
PLASTIKE



Kodi	Dimensionet	Çmimi
KXB8040WF	795X380X307MM	<b>9.500</b>



SET VALIXHE C BLOCK ME  
DOREZE ALUMINI 3 NE 1



Kodi	Dimensionet	Çmimi
KXCAS454085	450X380X845MM	<b>17.900</b>

SET VALIXHE VEGLASH BLOCK 4 NE 1



Kodi	Dimensionet	Çmimi
KMSS553585B	530X355X825MM	<b>9.900</b>

VALIXHE VEGLASH C BLOCK 4 ME DOREZE ALUMINI PER SISTEM MODULAR



Kodi	Dimensionet	Çmimi
KXCA454040	450X380X388MM	<b>9.900</b>

VALIXHE VEGLASH C BLOCK ME DOREZE ALUMINI



Kodi	Dimensionet	Çmimi
KXCA454015	450X380X168MM	<b>3.900</b>
KXCA454030	450x380x297MM	<b>6.690</b>

VALIXHE VEGLASH COMPACT BLOCK 4 ME RROTA PER SISTEM MODULAR



Kodi	Dimensionet	Çmimi
KXC454040	450X380X380MM	<b>9.900</b>

VALIXHE VEGLASH COMPACT BLOCK 1 / BLOCK 2 / BLOCK 3



Kodi	Dimensionet	Çmimi
KXC454015	450X380X135MM	<b>2.900</b>
KXC454015P	450X380X135MM	<b>3.500</b>
KXC454030	450X380X290MM	<b>5.800</b>

VALIXHE VEGLASH HEAVY BLOCK ME RROTA PER SISTEM MODULAR



Kodi	Dimensionet	Çmimi
KHVW	450X360X640MM	<b>5.500</b>

VALIXHE VEGLASH HEAVY BLOCK 1 / 2 / 3 / 4 PER SISTEM MODULAR



Kodi	Dimensionet	Çmimi
KHV453520	445X360X216MM	<b>4.500</b>
KHV603520	585X360X217MM	<b>5.500</b>
KHV453535	445X360X337MM	<b>2.990</b>
KHV603535	585X360X337MM	<b>3.900</b>



VALIXHE VEGLASH EVO ME KAPESE METALIKE



Kodi	Dimensionet	Çmimi
KEV5025AL	476X260X256MM	<b>2.200</b>
KEV5530AL	548X274X286MM	<b>2.390</b>

VALIXHE VEGLASH TITAN ME KAPESE PLASTIKE



Kodi	Dimensionet	Çmimi
KTIP5025	496X258X240MM	<b>2.190</b>
KTIP5530	554X286X276MM	<b>2.990</b>

KUTI ORGANIZUESE TAGER ME 3 KATE



Kodi	Dimensionet	Çmimi
KTC40306B	415X290X290MM	<b>4.990</b>

VALIXHE PUNE ME RROTA CARTT



Kodi	Dimensionet	Çmimi
KCT4040	396X370X1008MM	<b>3.500</b>

VALIXHE VEGLASH OPTIMA ME KAPESE PLASTIKE



Kodi	Dimensionet	Çmimi
KOPA5025	470X256X238MM	<b>2.790</b>
KOPA5530	540X278X269MM	<b>2.990</b>
KOPA6030	586X296X305MM	<b>3.500</b>

KUTI ORGANIZUESE AKSESORESH



Kodi	Dimensionet	Çmimi
KNO30205S	287X186X50MM	<b>590</b>
KNO35255S	344X249X50MM	<b>790</b>
KNO40305S	399X303X50MM	<b>990</b>

Ekskluzive në

**BAUMARKET**

**YATO** ®





## KARROCE VEGLASH E KOMPLETUAR ME 6 SIRTARE



**IRI**

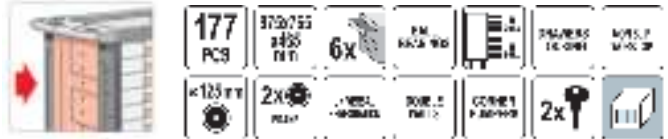

### Sirtari 1

- 6, 7, 8, 9, 10, 11, 12, 13, 14, 15, 16, 17, 18, 19, 20, 21 mm; CrV;
- 22, 24, 27, 28, 30, 32 mm; CrV;
- 6x7, 8x9, 10x11, 12x13, 14x15, 16x17, 18x19 mm; CrV

### Sirtari 2

- 3x75, 5x100, 5x150, 6x38, 6x100, 6x150, 8x150 mm; CrMo;
- PH0x100, PH1x75, PH1x100, PH2x38, PH2x100, PH2x150, PH3x150 mm; CrMo;
- 160 mm;
- 180 mm;
- 160 mm me maje te drejte;
- 160 mm me maje te kthyer;

### Sirtari 3

- 1/2" (12.7 mm): 10, 11, 12, 13, 14, 15, 16, 17, 18, 19, 20, 21, 22, 23, 24, 27, 30, 32 mm;
- 1/2" (12.7 mm); (12.7 mm); (12.7 mm); CrV 50BV30;
- 1/2" (12.7 mm); CrV 50BV30
- 1/2" (12.7 mm): 16, 21 mm; CrV 50BV30;
- 1/2" (12.7 mm); (255 mm); CrV 50BV30;
- 1/2" (12.7 mm); (255 mm); 72T; CrV 6140;
- T20, T25, T30, T40, T45, T50, T55 (L=30 mm); T20, T25, T30, T40, T45, T50, T55
- 4, 5, 6, 7, 8, 10, 12 mm (L=30 mm); 4, 5, 6, 7, 8, 10, 12 mm (L=75 mm); AISI S2;
- M5, M6, M8, M10, M12 (L=30 mm); M5, M6, M8, M10, M12 (L=75 mm); AISI S2;
- 1/2" (12.7 mm), 3/8" (9.5 mm);
- 1/2" (12.7 mm): 8, 9, 10, 11, 12, 13, 14, 15, 16, 17, 18, 19, 20, 21 mm (L=76 mm); CrV

### Sirtari 4

- 300 g (L=300 mm);
- 40 mm (L=350 mm);
- 10x8x142 mm, 12x10x152 mm, 16x13x172 mm;
- 3/8" (9.5 mm): 6, 7, 8, 9, 10, 11, 12, 13, 14, 15, 16, 17, 18, 19, 20, 21, 22 mm; CrV 50BV30;
- 3/8" (9.5 mm); (76, 152.4 mm); CrV 50BV30;
- 3/8" (9.5 mm); CrV 50BV30;
- 3/8" (9.5 mm); (198 mm); CrV 50BV30;
- 3/8" (9.5 mm); (198 mm); CrV 50BV30;
- 1/4" (6.3 mm): 3.5, 4, 4.5, 5, 5.5, 6, 7, 8, 9, 10, 11, 12, 13, 14 mm; CrV 50BV30;
- 1/4" (6.3 mm): 8, 10, 11, 12, 13 mm; CrV 50BV30;
- 1/4" (6.3 mm); (50.8, 101.6 mm); CrV 6140;
- 1/4" (6.3 mm); CrV 50BV30;
- 1/4" (6.3 mm); (152.4 mm); CrV 50BV30
- 1/4" (6.3 mm); (155 mm); 72T; CrV 6140;
- 1/4" (6.3 mm); (150 mm); CrV 50BV30



## KARROCE VEGLASH ME 6 SIRTARE PA VEGLA

**IRI**



Kodi	Hapja	Çmimi
YT-55299	me 6 sirtare	<b>42.900</b>



## KARROCE VEGLASH METALIKE PROFESIONALE ME 7 SIRTARE ( BOSH ) 665X453X932MM

Karroce veglash profesionale e pajisur me 7 sirtarë: 5 të ngushtë, një të mesëm dhe një të madh. Të gjithë sirtarët mbrohen me kyçe qendrore. Me rrota rotulluese me frenim, duke mundësuar lëvizje të lehte. Pjesa e sipërme është prej metali të ngurtë të mbuluar me një sfunjer që nuk rrëshqet - ngarkesa maksimale e sipërme është 210 kg. Dimensionet e karroses janë 665 x 453 x 932 mm.

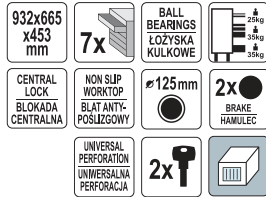

Kodi	Hapja	Çmimi
YT-09000	me 7 sirtare	<b>36.900</b>

## KARROCE VEGLASH METALIKE ME 3 SIRTARE 795X790X370MM

**IRI**



Kodi	Hapja	Çmimi
YT-55210	me 3 sirtare	<b>9.900</b>

## KUTI VEGLASH DYSHE ME RROTA ME KAPESE PLASTIKE



## KUTI ORGANIZUESE ME KAPESE PLASTIKE



Kodi	Permasa	Çmimi
YT-09160	495x350x710 mm	<b>5.900</b>

Kodi	Permasa	Çmimi
YT-09181	531 x 379 x 77 mm	<b>4.900</b>
YT-09182	263 x 363 x 77 mm	<b>3.200</b>

## KOMPLET KRIKETI 173 COPE 1/4", 3/8" & 1/2"

**IRI**

173 PCS 1/2" 12.5mm 3/8" 10mm 1/4" 6.3mm CrV 50BV30 CrV 6150 CrMo 440 S2 72T AS-DRIVE



- 1/2" (12.7 mm): 10, 11, 12, 13, 14, 15, 16, 17, 18, 19, 20, 21, 22, 23, 24 mm (L=38 mm); 27, 30, 32 mm (L=42 mm); 3/8" (9.5 mm): 10, 11, 12, 13, 14, 15, 16 mm (L=28 mm); 17, 18, 19 mm (L=30 mm); 1/4" (6.3 mm): 4, 4.5, 5, 5.5, 6, 7, 8, 9, 10, 11, 12, 13, 14 mm (L=25 mm); CrV 50BV30
- 1/2" (12.7 mm): 16, 17, 18, 19, 22 mm (L=76 mm); 3/8" (9.5 mm): 10, 11, 12, 13, 14, 15 mm (L=63 mm); 1/4" (6.3 mm): 4, 5, 6, 7, 8, 9, 10 mm (L=50 mm); CrV 50BV30;
- 1/2" (12.7 mm): E18, E20, E24, 3/8" (9.5 mm): E10, E11, E12, E14, E16, 1/4" (6.3 mm): E4, E5, E6, E7, E8; CrV 6150;
- 1/2" (12.7 mm): (127, 254 mm), 3/8" (9.5 mm): (152.4 mm), 1/4" (6.3 mm): (50.8, 101.6 mm); CrV 50BV30;
- 3/8" (9.5 mm) (F) x 1/2" (12.7 mm); CrV 50BV30;
- 1/2" (12.7 mm), 3/8" (9.5 mm), 1/4" (6.3 mm); CrV 50BV30;
- 1/2" (12.7 mm): 16, 21 mm; 3/8" (9.5 mm): 18 mm; CrV 50BV30;
- 1/4" (6.3 mm): (152.4 mm); CrV 40;
- 1/2" (12.7 mm): (255 mm), 3/8" (9.5 mm): (200 mm), 1/4" (6.3 mm): (155 mm); 72T; CrMo 440;
- 1/4" (6.3 mm): (150 mm); CrV 50BV30;
- 1/2" (12.7 mm) x 5/16" (7.9 mm), 3/8" (9.5 mm) x 5/16" (7.9 mm); CrV 50BV30
- 1/4" (6.3 mm) x 1/4" (6.3 mm); CrV 50BV30;
- 5/16" (7.9 mm): 8, 10, 12 mm (L=30 mm); AISI S2
- 5/16" (7.9 mm): PH3, PH4 (L=30 mm); AISI S2;
- 5/16" (7.9 mm): PZ3, PZ4 (L=30 mm); AISI S2;
- 5/16" (7.9 mm): T40, T45, T50, T55, T60, T70 (L=30 mm); AISI S2;
- 5/16" (7.9 mm): T40, T45, T50, T55, T60, T70 (L=30 mm); AISI S2;
- 5/16" (7.9 mm): 7, 8, 10, 12, 14 mm (L=30 mm); AISI S2;
- 1/4" (6.3 mm): T5, T6, T7 (L=25 mm); AISI S2;
- 1/4" (6.3 mm): T7, T10, T15, T20, T25, T27, T30, T40, T45 (L=25 mm); AISI S2;
- 1/4" (6.3 mm): M5, M6, M8 (L=25 mm); AISI S2;
- 1/4" (6.3 mm): RM5, RM6, RM7, RM8, RM9 (L=25 mm); AISI S2;
- 1/4" (6.3 mm) 4, 5.5, 6.5, 7 mm (L=37 mm); AISI S2 / CrV 6150;
- 1/4" (6.3 mm): PH0, PH1, PH2 (L=37 mm); AISI S2 / CrV 6150;
- 1/4" (6.3 mm) PZ0, PZ1, PZ2 (L=37 mm); AISI S2 / CrV 6150;
- 1/4" (6.3 mm): T8, T9, T10, T15, T20, T25, T27, T30 (L=37 mm); AISI S2 / CrV 6150;
- 1/4" (6.3 mm): T8, T9, T10, T15, T20, T25, T27, T30 (L=37 mm); AISI S2 / CrV 6150;
- 1/4" (6.3 mm): 3, 4, 5, 6 mm (L=37 mm); AISI S2 / CrV 6150;
- 1.25, 1.5, 2, 2.5, 3, 4, 5 mm; CrV 6150

Kodi	Kapja	Çmimi
YT-38931	1/4" (6.3 mm), 3/8" (9.5 mm), 1/2" (12.7 mm)	<b>15.900</b>

## KOMPLET KRIKETI 1/4" & 1/2" + VEGLA DORE, 122 COPE

122 PCS 1/2" 12.7mm 1/4" 6.3mm CrV 50BV30 CrV 6150 CrMo 440 S2 72T AS-DRIVE



- 1/2" (12.7 mm): 10, 11, 12, 13, 14, 15, 16, 17, 18, 19, 20, 21, 22, 24 mm (L=38 mm); 27, 30, 32 mm (L=42 mm); 1/4" (6.3 mm): 4, 4.5, 5, 5.5, 6, 7, 8, 9, 10, 11, 12, 13, 14 mm (L=25 mm); CrV 50BV30;
- 1/2" (12.7 mm): 14, 15, 17, 19, mm (L=76 mm); 1/4" (6.3 mm) 4, 5, 6, 7, 8, 9 mm (L=50 mm); CrV 50BV30
- 1/2" (12.7 mm): E10, E11, E12, E14, E16, E18, E20, E24, CrV 50BV30;
- 1/2" (12.7 mm): (254 mm), 1/4" (6.3 mm): (152.4 mm); CrV 50BV30
- 3/8" (9.5 mm) (F) x 1/2" (12.7 mm) (M), 3/8" (9.5 mm) (F) x 1/4" (6.3 mm) (M); CrV 50BV30;
- 1/2" (12.7 mm), 1/4" (6.3 mm); CrV 50BV30
- 1/2" (12.7 mm): 16, 21 mm; CrV 50BV30;
- 1/2" (12.7 mm): (255 mm), 1/4" (6.3 mm): (155 mm); 72T; CrMo 440;
- 1/4" (6.3 mm): (150 mm); CrV 50BV30;
- 1/4" (6.3 mm) x 1/4" (6.3 mm); CrV 50BV30;
- 1/4" (6.3 mm): 3, 4, 5, 6 mm (L=25 mm); AISI S2;
- 1/4" (6.3 mm): PH0, PH1, PH2 (L=25 mm); AISI S2;
- 1/4" (6.3 mm): PZ0, PZ1, PZ2 (L=25 mm); AISI S2;
- 1/4" (6.3 mm): 4, 5.5, 6.5 mm (L=37 mm); AISI S2 / CrV 6150;
- 1/4" (6.3 mm): PH1, PH2, PH3 (L=37 mm); AISI S2 / CrV 6150;
- 1/4" (6.3 mm): PZ2, PZ3 (L=37 mm); AISI S2 / CrV 6150;
- 1/4" (6.3 mm): T8, T10, T15, T20, T25 (L=37 mm); AISI S2 / CrV 6150;
- 1/4" (6.3 mm): T10, T15, T20, T25, T40 (L=37 mm); AISI S2 / CrV 6150;
- 1/4" (6.3 mm): 3, 4, 5, 6 mm (L=37 mm); AISI S2 / CrV 6150;
- 8, 9, 10, 11, 12, 13, 14, 15, 16, 17, 18, 19 mm; CrV;
- 4x100, 6x150, PH2x100, PH3x150 mm; S2;
- 180 mm;
- 160 mm;
- 160 mm;
- 250 mm; CrV;
- 300 g;
- 2, 2.5, 3, 4, 5, 6, 7, 8, 10 mm; CrV 6150

Kodi	Kapja	Çmimi
YT-38901	1/4" (6.3 mm) 1/2" (12.7 mm)	<b>17.900</b>



## KOMPLET KRIKETI 1/4"+ 3/8" & 1/2"

### 216 COPE

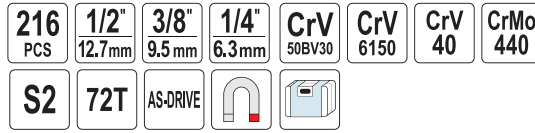

- 1/2" (12.7 mm): 10, 11, 12, 13, 14, 15, 17, 19, 20, 21, 22, 24 mm (L=38 mm); 27, 30, 32 mm (L=42 mm), 3/8" (9.5 mm): 10, 11, 12, 13, 14, 15, 16 mm (L=28 mm); 17, 18, 19 mm (L=30 mm), 1/4" (6.3 mm): 4, 4.5, 5, 5.5, 6, 7, 8, 9, 10, 11, 12, 13, 14 mm (L=25 mm); CrV 50BV30;
- 1/2" (12.7 mm): 16, 17, 18, 19, 22 mm (L=76 mm), 3/8" (9.5 mm) : 10, 11, 12, 13, 14, 15 mm (L=63 mm), 1/4" (6.3 mm): 4, 5, 6, 7, 8, 9, 10 mm (L=50 mm); CrV 50BV30;
- 1/2" (12.7 mm): E20, E22, E24, 3/8" (9.5 mm): E10, E11, E12, E14, E16, E18 1/4" (6.3 mm): E4, E5, E6, E7, E8; CrV 50BV30;
- 1/2" (12.7 mm); (127, 254 mm), 3/8" (9.5 mm); (125 mm), 1/4" (6.3 mm); (50.8, 101.6 mm); CrV 50BV30;
- 1/2" (12.7 mm), 3/8" (9.5 mm), 1/4" (6.3 mm); CrV 50BV30;
- 1/2" (12.7 mm): 16, 21 mm, 3/8" (9.5 mm): 18 mm; CrV 50BV30;
- 1/2" (12.7 mm); (255 mm), 1/4" (6.3 mm); (152.4 mm); CrV 40;
- 1/2" (12.7 mm); (255 mm), 3/8" (9.5 mm); (200 mm), 1/4" (6.3 mm); (155 mm); 72T, CrMo 440;
- 1/4" (6.3 mm); (150 mm); CrV 50BV30;
- 1/4" (6.3 mm); (200 mm);
- 1/2" (12.7 mm) x 5/16" (7.9 mm), 3/8" (9.5 mm) x 5/16" (7.9 mm) ; CrV 50BV30;
- 1/4" (6.3 mm) x 1/4" (6.3 mm); CrV 50BV30;
- 5/16" (7.9 mm): 6, 6.5, 8 mm (L=30 mm); AISI S2;
- 5/16" (7.9 mm): PH3, PH4 (L=30 mm); AISI S2;
- 5/16" (7.9 mm): PZ3, PZ4 (L=30 mm); AISI S2;
- 5/16" (7.9 mm): T25, T27, T30, T35, T40 x2, T45, T50 (L=30 mm); AISI S2;
- 5/16" (7.9 mm): T27, T30, T35, T40, T45, T50 (L=30 mm); AISI S2;
- 5/16" (7.9 mm): 5.5, 6, 6.5, 7, 8 mm (L=30 mm); AISI S2;
- 5/16" (7.9 mm): M5, M6, M8, M10 (L=30 mm); AISI S2;
- 1/4" (6.3 mm): 4, 5.5, 6.5 mm (L=25 mm); AISI S2;
- 1/4" (6.3 mm): PH1, PH2 (L=25 mm); AISI S2; 1/4" (6.3 mm): PZ1, PZ2 (L=25 mm); AISI S2;
- 1/4" (6.3 mm): 3, 4, 5, 6 mm (L=25 mm); AISI S2; 1/4" (6.3 mm): 3, 4, 5, 6 mm (L=25 mm)
- 1/4" (6.3 mm): T8, T10, T15, T20, T25 (L=25 mm); AISI S2;
- 1/4" (6.3 mm): T8, T10 x2, T15 x2, T20 x2, T25 x2, T40 (L=25 mm); AISI S2;
- 1/4" (6.3 mm): M5, M6, M8 (L=25 mm); AISI S2; 1/4" (6.3 mm): S1, S2 (L=25 mm); AISI S2;
- 1/4" (6.3 mm): 1, 2, 3 mm (L=25 mm); AISI S2; 1/4" (6.3 mm): 6, 8, 10 mm (L=25 mm)
- 1/4" (6.3 mm): 4, 6, 8 mm (L=25 mm); AISI S2;
- 1/2" (12.7 mm): T55, T60 (L=50 mm); AISI S2 / CrV 50BV30;
- 1/4" (6.3 mm): 6, 6.5, 8 mm (L=37 mm); AISI S2 / CrV 50BV30;
- 1/4" (6.3 mm): PH3, PH4 (L=37 mm); AISI S2 / CrV
- 50BV30; 1/4" (6.3 mm): PZ3, PZ4 (L=37 mm); AISI S2 / CrV 50BV30;
- 1/4" (6.3 mm): T25, T27, T30, T35, T40 x2, T45, T50 (L=37 mm); AISI S2 / CrV 50BV30;
- 1/4" (6.3 mm): T27, T30, T35, T40, T45, T50 (L=37 mm); AISI S2 / CrV 50BV30;
- 1/4" (6.3 mm): 5.5, 6, 6.5, 7, 8 mm (L=37 mm); AISI S2 / CrV 50BV30;
- 1/4" (6.3 mm): M5, M6, M8, M10 (L=37 mm); AISI S2 / CrV 50BV30;
- 8, 10, 11, 12, 13, 14, 15, 16, 17, 18, 19, 22 mm; CrV;
- 1.27, 1.5, 2, 2.5, 3, 4, 5 mm; CrV 6150

Kodi	Kapja	Çmimi
YT-38841	1/4" (6.3 mm), 3/8" (9.5 mm), 1/2" (12.7 mm)	<b>19.500</b>

## KOMPLET KRIKETI CRV 1/4"

### 38COPE



- 1/4" (6.3 mm): 3.5, 4, 4.5, 5, 5.5, 6, 7, 8, 9, 10, 11, 12, 13, 14 mm (L=25 mm); CrV 50BV30;
- 1/4" (6.3 mm); (50.8, 101.6 mm); CrV 50BV30
- 1/4" (6.3 mm); CrV 50BV30;
- 1/4" (6.3 mm); (152.4 mm); CrV 40;
- 1/4" (6.3 mm); (155 mm); 72T, CrMo 440;
- 1/4" (6.3 mm); (150 mm); CrV 50BV30;
- 1/4" (6.3 mm): 4, 5.5, 6.5 mm (L=37 mm); AISI S2 / CrV 6150;
- 1/4" (6.3 mm): PH1, PH2 (L=37 mm); AISI S2 / CrV 6150;
- 1/4" (6.3 mm): PZ1, PZ2 (L=37 mm); AISI S2 / CrV 6150;
- 1/4" (6.3 mm): T10, T15, T20, T25, T30, T40 (L=37 mm); AISI S2 / CrV 6150;
- 1/4" (6.3 mm): 3, 4, 5, 6, 8 mm (L=37 mm); AISI S2 / CrV 6150

Kodi	Kapja	Çmimi
YT-14471	1/4" (6.3 mm)	<b>3.900</b>







**KOMPLET KRIKETI 3/8"**  
22 COPE



**IRI**

22 PCS	3/8" 9.5 mm	CrV 50BV30	CrV 40
CrMo 440	72T	AS-DRIVE	

-  3/8" (9.5 mm): 6, 7, 8, 9, 10, 11, 12, 13, 14, 15, 16 mm (L=28 mm); 17, 18, 19, 20, 21, 22 mm (L=30 mm); CrV 50BV30;
-  3/8" (9.5 mm); (76, 152.4 mm); CrV 50BV30;
-  3/8" (9.5 mm); CrV 50BV30;
-  3/8" (9.5 mm); (198 mm); CrV 40;
-  3/8" (9.5 mm); (200 mm); 72T; CrMo 440

Kodi	Kapja	Çmimi
YT-38561	3/8" (9.5 mm)	<b>3.900</b>



**KOMPLET KRIKETI**  
1/2" 12 COPE CRV





**KOMPLET KRIKETI**  
1/2" 19 COPE CRV



12 PCS	1/2" 12.7 mm	CrV 50BV30	
CrMo 440	72T	AS-DRIVE	

-  1/2" (12.7 mm): 10, 11, 12, 13, 14, 15, 17, 19, 21, 24 mm (L=38 mm); CrV 50BV30;
-  1/2" (12.7 mm); (127 mm); CrV 50BV30;
-  1/2" (12.7 mm); (255 mm); 72T; CrMo 440

Kodi	Kapja	Çmimi
YT-38821	1/2" (12.7 mm)	<b>2.900</b>























-  1/2" (12.7 mm): 8, 9, 10, 11, 12, 13, 14, 15, 16, 17, 19, 21, 22, 23, 24 mm (L=38 mm); 27, 30, 32 mm (L=42 mm); CrV 50BV30;
-  1/2" (12.7 mm); (255 mm); 72T; CrMo 440

Kodi	Kapja	Çmimi
YT-38681	1/2" (12.7 mm)	<b>4.500</b>

**SET ME 68 VEGLA ELEKTRICISTI**



68 PCS	1/4" 6.3 mm	CrV 50BV30	CrV 6150	S2	1000 V	
-----------	----------------	---------------	-------------	----	-----------	---

-  1/4" (6.3 mm): 4, 4.5, 5, 5.5, 6, 7, 8, 9, 10, 11, 12, 13 mm (L=25 mm); CrV 50BV30;
-  140 mm;
-  190 mm; 3CRB
-  150 mm;
-  160 mm; 1000 V; CrV;
-  160 mm; 1000 V; CrV
-  3 m x 16 mm;
-  175 mm;
-  19.5 x 190 mm;
-  1.5 V; 9 LED
-  9 mm;
-  19 mm x 20 mm;
-  1/4" (6.3 mm); (150 mm); CrV 50BV30;
-  1/4" (6.3 mm) x 1/4" (6.3 mm); CrV 6140;
-  10 g;
-  1.4, 2.0, 2.4 mm; PH00, PH0, PH1; S2
-  4x100, 5.5x125, PH1x80, PH2x100 mm; 1000V; S2
-  1/4" (6.3 mm); 3, 4, 5, 5.5, 6 mm (L=25 mm); AISI S2;
-  1/4" (6.3 mm); PH1, PH2, PH3 (L=25 mm); AISI S2;
-  1/4" (6.3 mm); T8, T10, T15, T20, T25, T27 (L=25 mm); AISI S2;
-  1/4" (6.3 mm); 2, 2.5, 3, 4, 5, 6 (L=25 mm); AISI S2;
-  1.5, 2, 2.5, 3, 4, 5, 6, 7, 8, 10 mm; CrV 6150

Kodi	Çmimi
YT-39009	<b>15.900</b>

## KOMPLET KRIKETI 1/4" & 1/2" 108 COPE CRV

<b>108</b> PCS	<b>1/2"</b> 12.7mm	<b>1/4"</b> 6.3mm	<b>CrV</b> 50BV30	<b>CrV</b> 6150	<b>CrV</b> 40
<b>CrMo</b> 440	<b>S2</b>	<b>72T</b>	<b>AS-DRIVE</b>		



- 1/2" (12.7 mm): 10, 11, 12, 13, 14, 15, 16, 17, 18, 19, 20, 21, 22, 24 mm (L=38 mm); 27, 30, 32 mm (L=42 mm); 1/4" (6.3 mm): 4, 4.5, 5, 5.5, 6, 7, 8, 9, 10, 11, 12, 13, 14 mm (L=25 mm); CrV 50BV30;
- 1/2" (12.7 mm): 14, 15, 17, 19, 22 mm (L=76 mm), 1/4" (6.3 mm): 6, 7, 8, 9, 10, 11, 12, 13 mm (L=50 mm); CrV 50BV30;
- 1/2" (12.7 mm): E10, E11, E12, E14, E16, E18, E20, E24, 1/4" (6.3 mm): E4, E5, E6, E7, E8; CrV 50BV30;
- 1/2" (12.7 mm); (127, 254 mm), 1/4" (6.3 mm); (50.8, 101.6 mm)
- 3/8" (9.5 mm) (F) x 1/2" (12.7 mm) (M); CrV 50BV30;
- 1/2" (12.7 mm), 1/4" (6.3 mm); CrV 50BV30;
- 1/2" (12.7 mm): 16, 21 mm; CrV 50BV30;
- 1/4" (6.3 mm); (152.4 mm); CrV 40;
- 1/2" (12.7 mm); (255 mm), 1/4" (6.3 mm); (155 mm); 72T; CrMo 440;
- 1/4" (6.3 mm); (150 mm); CrV 50BV30;
- 5/16" (7.9 mm): 8, 10, 12 mm (L=30 mm); AISI S2;
- 5/16" (7.9 mm): PH3, PH4 (L=30 mm); AISI S2;
- 5/16" (7.9 mm): PZ3, PZ4 (L=30 mm); AISI S2;
- 5/16" (7.9 mm): T40, T45, T50, T55, T60 (L=30 mm); AISI S2;
- 5/16" (7.9 mm): 7, 8, 10, 12, 14 mm (L=30 mm); AISI S2;
- 1/4" (6.3 mm): 4, 5, 5.5, 6.5 mm (L=37 mm); AISI S2 / CrV 50BV30;
- 1/4" (6.3 mm): PH1, PH2 (L=37 mm); AISI S2 / CrV 50BV30;
- 1/4" (6.3 mm): PZ1, PZ2 (L=37 mm); AISI S2 / CrV 50BV30;
- 1/4" (6.3 mm): T8, T10, T15, T20, T25, T27, T30 (L=37 mm); AISI S2 / CrV 50BV30;
- 1/4" (6.3 mm): 3, 4, 5, 6 mm (L=37 mm); AISI S2 / CrV 50BV30;
- 1.5, 2, 2.5 mm; CrV 6150

Kodi	Kapja	Çmimi
YT-38791	1/4" (6.3 mm) 1/2" (12.7 mm)	<b>12.500</b>

## KOMPLET KRIKETI 94 COPE 1/2" & 1/4"

**I RI**

<b>94</b> PCS	<b>1/2"</b> 12.7mm	<b>1/4"</b> 6.3mm	<b>CrV</b> 50BV30	<b>CrV</b> 6150	<b>CrV</b> 40
<b>CrMo</b> 440	<b>S2</b>	<b>72T</b>	<b>AS-DRIVE</b>		



- 1/2" (12.7 mm): 10, 11, 12, 13, 14, 15, 16, 17, 18, 19, 20, 21, 22, 23, 24 mm (L=38 mm); 27, 30, 32 mm (L=42 mm), 1/4" (6.3 mm): 4, 4.5, 5, 5.5, 6, 7, 8, 9, 10, 11, 12, 13, 14 mm (L=25 mm); CrV 50BV30;
- 1/2" (12.7 mm): 14, 15, 17, 19 mm (L=76 mm), 1/4" (6.3 mm): 6, 7, 8, 9, 10, 11, 12, 13 mm (L=50 mm); CrV 50BV30;
- 1/2" (12.7 mm); (127, 254 mm), 1/4" (6.3 mm); (50.8, 101.6 mm); CrV 50BV30;
- 3/8" (9.5 mm) (F) x 1/2" (12.7 mm) (M); CrV 50BV30;
- 1/2" (12.7 mm), 1/4" (6.3 mm); CrV 50BV30;
- 1/2" (12.7 mm): 16, 21 mm; CrV 50BV30;
- 1/4" (6.3 mm); (152.4 mm); CrV 40;
- 1/2" (12.7 mm); (255 mm), 1/4" (6.3 mm); (155 mm); 72T; CrMo 440
- 1/4" (6.3 mm); (150 mm); CrV 50BV30;
- 1/2" (12.7 mm) x 5/16" (7.9 mm); CrV 50BV30;
- 5/16" (7.9 mm): 8, 10, 12 mm (L=30 mm); AISI S2;
- 5/16" (7.9 mm): 8, 10, 12 mm (L=30 mm); AISI S2
- 5/16" (7.9 mm): PH3, PH4 (L=30 mm); AISI S2;
- 5/16" (7.9 mm): PZ3, PZ4 (L=30 mm); AISI S2;
- 5/16" (7.9 mm): T40, T45, T50, T55 (L=30 mm); AISI S2;
- 1/4" (6.3 mm): 4, 5.5, 7 mm (L=37 mm); AISI S2 / CrV 6150
- 1/4" (6.3 mm): PH1, PH2 (L=37 mm); AISI S2 / CrV 6150;
- 1/4" (6.3 mm): PZ1, PZ2 (L=37 mm); AISI S2 / CrV 6150;
- 1/4" (6.3 mm): T8, T10, T15, T20, T25, T30 (L=37 mm); AISI S2 / CrV 6150;
- 1/4" (6.3 mm): 3, 4, 5, 6 mm (L=37 mm); AISI S2 / CrV 6150;
- 1.5, 2, 2.5 mm; CrV 6150

Kodi	Kapja	Çmimi
YT-12681	1/4" (6.3 mm) 1/2" (12.7 mm)	<b>9.900</b>



KOMPLET KRIKETI 1/4"



56 pcs  
1/4"  
6.3mm  
CrMo  
440

Kodi	Sasia	Çmimi
YT-14501	56 cope	<b>3.900</b>

KOMPLET KRIKETI 1/4" & 1/2"



72 pcs  
1/2"  
12.5mm  
1/4"  
6.3mm

Kodi	Seti	Çmimi
YT-38782	72 cope	<b>6.900</b>

KOMPLET KRIKETI 1/2"



82 pcs  
1/2"  
12.5mm  
CrV  
50BV30  
CrMo  
440

Kodi	Sasia	Çmimi
YT-12691	82 cope	<b>9.900</b>

KOMPLET KRIKETI 1/4" & 1/2"



128 pcs  
CrV  
50BV30  
1/4"  
6.3mm  
CrV  
6150  
AS-DRIVE  
CrMo  
440

Kodi	Seti	Çmimi
YT-38872	128 cope	<b>14.500</b>

SET KRIKETI 1/4", 3/8" & 1/2"



150 pcs  
1/2"  
12.5mm  
METRIC & S.A.E.  
CrV  
50BV30  
S2  
72T

Kodi	Seti	Çmimi
YT-38811	150 cope	<b>22.900</b>

KOMPLET KRIKETI 1/4" & 1/2"



111 pcs  
CrV  
50BV30  
1/4"  
6.3mm  
CrV  
6150  
AS-DRIVE  
CrMo  
440

Kodi	Seti	Çmimi
YT-38831	111 cope	<b>12.500</b>



### VINC MOTORRI 1000KG



Kodi	Pesha	Çmimi
YT-55556	1000 Kg	<b>39.500</b>

### VINC MOTORRI 2000KG



Kodi	Pesha	Çmimi
YT-55557	2000 Kg	<b>49.500</b>

### KRIK KAMBIO 0.5 TON 1140MM-1945MM



Kodi	Kapaciteti	Çmimi
YT-55600	500 kg	<b>19.900</b>

### BALANCUES MOTORRI 680KG



Kodi	Pesha	Çmimi
YT-55565	680 Kg	<b>4.500</b>

### KRIK HIDRAULIK ME PROFIL TE ULET 2T



2t

359  
89 mm



Kodi	Lartesia	Pesha	Çmimi
YT-1720	359mm	2T	<b>9.900</b>

### DOREZA PUNE PA GISHTA TE ZEZA 10"



Kodi	Masa	Çmimi
YT-74660	XL	<b>990</b>

### POMPE VAJI MANUALE

IRI



16-18  
l/min

45-90  
cm

max  
55  
min

0.31  
CYCLE

AI

FOR OIL  
DO  
OLEJU



Kodi	Kapaciteti	Çmimi
YT-0712	16-18 l/min	<b>3.500</b>

### SET ME PASQYRE MEKANIKU

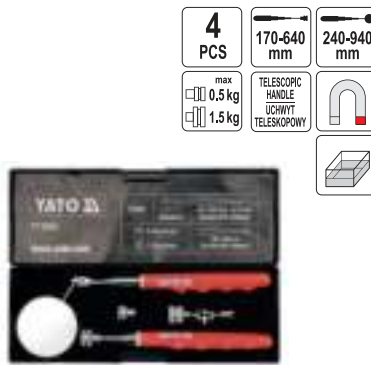

4  
PCS

170-640  
mm

240-940  
mm

max  
0,5 kg

TELESCOPIC  
HANDLE  
UCHWYT  
TELESKOPOWY



Kodi	Permasa [mm]	Çmimi
YT-0662	170-940	<b>1.550</b>

### CELES FILTRI VAJI ME RRIP



Kodi	Permasa [mm]	Çmimi
YT-0824	80-160 mm	<b>1.590</b>

### HINKE PLASTIKE



280  
mm

PP



Kodi	Permasa [mm]	Çmimi
YT-0697	280	<b>590</b>

### TAS PLASTIK 0.5L

IRI



50  
mm

155  
mm

0.5L



Kodi	Permasa [mm]	Çmimi
YT-51880	155	<b>250</b>

### TAS PLASTIK PER PRITJE VAJI

IRI



PE

Kodi	Volumi	Çmimi
YT-0716	10 litra	<b>1.790</b>
YT-0717	15 litra	<b>1.990</b>

### TAS MAGNETIK 110 MM



110  
mm



Kodi	Diametri	Çmimi
YT-08295	110 mm	<b>250</b>



VAJNICE PLASTIKE 270 ML /  
VAJNICE METALIKE 200 ML



IMPACT  
RESISTANT  
ODPORNY  
NA UDERZENIA

Kodi	[cm <sup>3</sup> ]	Çmimi
YT-0691	270	<b>350</b>
YT-06912	200	<b>350</b>

BIDON VAJI PLASTIK 1 L



Kodi	litra	Çmimi
YT-06980	1	<b>490</b>

BIDON VAJI PLASTIK 3 L



Kodi	litra	Çmimi
YT-06983	3	<b>690</b>

PISTOLETE GRASATIMI  
METALIKE E ZEZE

70  
MPa  
(max.)

31  
MPa

400  
cm<sup>3</sup>

Al



Kodi	Volumi	Çmimi
YT-0705	400 ml	<b>2.500</b>

PISTOLETE GRASATIMI  
ALUMINI PROFESIONALE  
TUB 330X56.4X1.2MM

27-41  
MPa

600  
cm<sup>3</sup>

Al



Kodi	Volumi	Çmimi
YT-07042	600 ml	<b>1.990</b>

POMPE GRASO MEKANIKE  
4KG ME TUB 150CM

1.5m

13.8  
MPa  
(max.)

4  
kg



Kodi	Volumi	Çmimi
YT-07061	4 kg	<b>5.500</b>

VALIXHE METALIKE  
ME 3 HAPJE



Kodi	Permasa	Çmimi
YT-0884	460x200x180MM	<b>3.950</b>

SHTRAT MEKANIKU PLASTIK  
ME 6 RROTA

6x

100  
cm



Kodi	Permasa	Çmimi
YT-0880	100 cm	<b>5.900</b>

SHTRAT MEKANIKU  
I PALOSSHEM

91  
cm

120  
kg

150  
kg

6x



Kodi	Permasa	Çmimi
YT-08802	91x41.5x13cm	<b>4.900</b>



CELES FISO STEL  
CHROME VANADIUM



Kodi	Permasa	Çmimi
YT-0336	7 mm	<b>150</b>
YT-0337	8 mm	<b>169</b>
YT-0338	9 mm	<b>175</b>
YT-0339	10 mm	<b>179</b>
YT-0340	11 mm	<b>189</b>
YT-0341	12 mm	<b>199</b>
YT-0342	13 mm	<b>220</b>
YT-0343	14 mm	<b>250</b>
YT-0344	15 mm	<b>280</b>
YT-0345	16 mm	<b>290</b>
YT-0346	17 mm	<b>320</b>
YT-0347	18 mm	<b>350</b>
YT-0348	19 mm	<b>390</b>
YT-0349	20 mm	<b>390</b>
YT-0350	21 mm	<b>390</b>
YT-0351	22 mm	<b>490</b>
YT-0352	23 mm	<b>590</b>
YT-0353	24 mm	<b>650</b>
YT-0354	25 mm	<b>790</b>
YT-0355	26 mm	<b>850</b>
YT-0356	27 mm	<b>890</b>
YT-0357	28 mm	<b>890</b>
YT-0358	29 mm	<b>950</b>
YT-0359	30 mm	<b>990</b>
YT-0360	32 mm	<b>990</b>

CELES PIPO I LEVIZSHEM



Kodi	Permasa	Çmimi
YT-1552	8 mm	<b>750</b>
YT-1554	10 mm	<b>750</b>
YT-1556	12 mm	<b>750</b>
YT-1557	13 mm	<b>750</b>
YT-1558	14 mm	<b>750</b>
YT-1559	15 mm	<b>750</b>

CELES FISO-STEEL  
CHROME VANADIUM



Kodi	Permasa	Çmimi
YT-00760	34 mm	<b>1.200</b>
YT-00761	36 mm	<b>1.490</b>
YT-00762	38 mm	<b>1.690</b>
YT-00763	41 mm	<b>1.900</b>
YT-00764	46 mm	<b>2.590</b>
YT-00765	48 mm	<b>2.990</b>
YT-00766	50 mm	<b>3.300</b>
YT-00767	55 mm	<b>5.900</b>
YT-00768	60 mm	<b>6.900</b>
YT-00769	65 mm	<b>7.500</b>

CELES FISO-STEEL KRIKET



Kodi	Permasa	Çmimi
YT-01906	6 mm	<b>390</b>
YT-01907	7 mm	<b>450</b>
YT-01908	8 mm	<b>450</b>
YT-01909	9 mm	<b>450</b>
YT-0191	10 mm	<b>450</b>
YT-0192	11 mm	<b>490</b>
YT-0193	12 mm	<b>490</b>
YT-0194	13 mm	<b>550</b>
YT-0195	14 mm	<b>590</b>
YT-0196	15 mm	<b>650</b>
YT-0197	16 mm	<b>690</b>
YT-0198	17 mm	<b>750</b>
YT-0199	18 mm	<b>790</b>
YT-0200	19 mm	<b>850</b>
YT-0201	22 mm	<b>950</b>
YT-0202	24 mm	<b>990</b>
YT-0203	25 mm	<b>1.190</b>
YT-0204	27 mm	<b>1.290</b>
YT-0205	30 mm	<b>1.390</b>
YT-0206	32 mm	<b>1.490</b>

CELES FISO-STEEL KRIKET ME  
KOKE TE LEVIZSHME



Kodi	Permasa	Çmimi
YT-1674	8 mm	<b>650</b>
YT-1675	9 mm	<b>650</b>
YT-1676	10 mm	<b>690</b>
YT-1677	11 mm	<b>690</b>
YT-1678	12 mm	<b>750</b>
YT-1679	13 mm	<b>790</b>
YT-1680	14 mm	<b>890</b>
YT-1681	15 mm	<b>850</b>
YT-1682	16 mm	<b>990</b>
YT-1683	17 mm	<b>1.100</b>
YT-1684	18 mm	<b>1.150</b>
YT-1685	19 mm	<b>1.250</b>
YT-1686	20 mm	<b>1.250</b>
YT-1687	21 mm	<b>1.350</b>
YT-1688	22 mm	<b>1.390</b>
YT-1690	24 mm	<b>1.450</b>
YT-1691	25 mm	<b>1.490</b>

CELES TAF HEXAGON



Kodi	Permasa	Çmimi
YT-05571	2.5 mm	<b>250</b>
YT-05572	3 mm	<b>260</b>
YT-05574	4 mm	<b>280</b>
YT-05576	5 mm	<b>350</b>
YT-05577	6 mm	<b>390</b>
YT-05578	7 mm	<b>390</b>
YT-05579	8 mm	<b>490</b>
YT-05581	10 mm	<b>690</b>

### CELES L TORX I GJATE

**IRI**

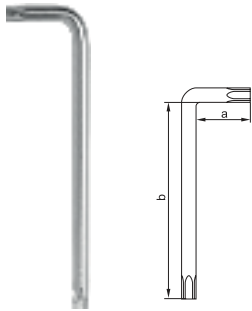

Kodi	Permasa [mm]	a [mm]	b [mm]	Çmimi
YT-05516	T20	19	95	<b>85</b>
YT-05517	T25	20	100	<b>89</b>
YT-05518	T27	21	105	<b>99</b>
YT-05519	T30	24	114	<b>139</b>
YT-05520	T40	28	121	<b>135</b>
YT-05521	T45	30	132	<b>150</b>
YT-05522	T50	32	152	<b>150</b>

### SET HEXAGON I GJATE 9 COPE 1.5-10MM

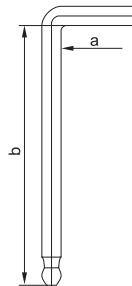
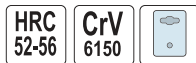

Kodi	Permasa [mm]	a [mm]	b [mm]	Çmimi
YT-0505	1,5, 2,2,5, 3,4,5, 6,8,10	15,16,18, 21,23,28, 31,35,39	74,81,88,95, 109,121,135, 157,174	<b>590</b>

### CELES TAF ME DOREZE KOKE TE RRUMBULLAKET

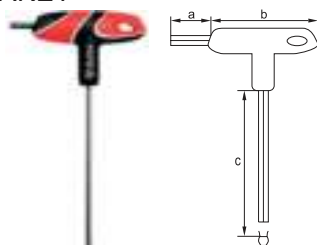

Kodi	Permasa [mm]	a [mm]	b [mm]	c [mm]	Çmimi
YT-05586	3.0	13	76	140	<b>250</b>
YT-05588	4.0	14	86	140	<b>290</b>
YT-05590	5.0	17	92	190	<b>350</b>
YT-05591	6.0	17	92	220	<b>390</b>
YT-05593	8.0	19	98	240	<b>490</b>
YT-05594	10.0	22	102	257	<b>590</b>

### CELES TAF I GOMUAR

1/4" 6.3mm 3/8" 9.5mm 1/2" 12.7mm

CrV 6140

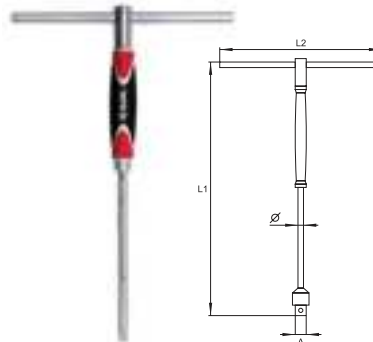
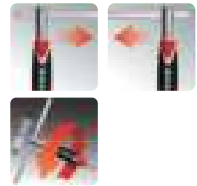

Kodi	Permasa [mm]	L1 [mm]	L2 [mm]	dia [mm]	Çmimi
YT-1565	1/4" (6.3 mm)	310	200	8	<b>750</b>
YT-1566	3/8" (9.5 mm)	310	200	10	<b>750</b>
YT-1567	1/2" (12.7 mm)	310	200	10	<b>850</b>

### SET TORX EXTRA I GJATE 9 COPE T10-T50

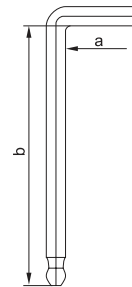
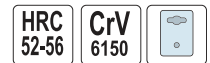

Kodi	Permasa [mm]	a [mm]	b [mm]	Çmimi
YT-0512	T10, T15, T20, T25, T27, T30, T40, T45, T50	15, 16, 19, 23, 26, 27, 32, 36, 41	78, 95, 109, 124, 143, 153, 180, 200, 222	<b>650</b>

### CELES PIPO I LEVIZSHEM



Kodi	Permasa [mm]	Gjatesia totale	Gjatesia dorezes	Çmimi
YT-15271	6 mm	450 mm	180 mm	<b>850</b>
YT-15272	8 mm	450 mm	180 mm	<b>850</b>
YT-15274	9 mm	450 mm	180 mm	<b>950</b>
YT-15276	11 mm	450 mm	180 mm	<b>990</b>
YT-15277	12 mm	450 mm	180 mm	<b>1.190</b>
YT-15279	14 mm	450 mm	180 mm	<b>1.290</b>
YT-15280	15 mm	450 mm	180 mm	<b>1.350</b>
YT-15281	16 mm	450 mm	180 mm	<b>1.390</b>

### CELES TAF TORX ME DOREZE



Kodi	Permasa [mm]	a [mm]	b [mm]	c [mm]	Çmimi
YT-05601	T8	13	76	100	<b>199</b>
YT-05602	T9	13	76	100	<b>220</b>
YT-05603	T10	13	76	100	<b>250</b>
YT-05604	T15	13	76	100	<b>250</b>
YT-05605	T20	13	76	130	<b>290</b>
YT-05606	T25	17	92	140	<b>330</b>

### CELES TAF TORX ME DOREZE



Kodi	Permasa [mm]	a [mm]	b [mm]	c [mm]	Çmimi
YT-05607	T27	17	92	140	<b>330</b>
YT-05608	T30	17	92	140	<b>350</b>
YT-05609	T40	17	92	170	<b>490</b>
YT-05610	T45	22	102	200	<b>590</b>
YT-05611	T50	22	102	200	<b>690</b>

### CELES TAF ME KOKE TE LEVIZSHME

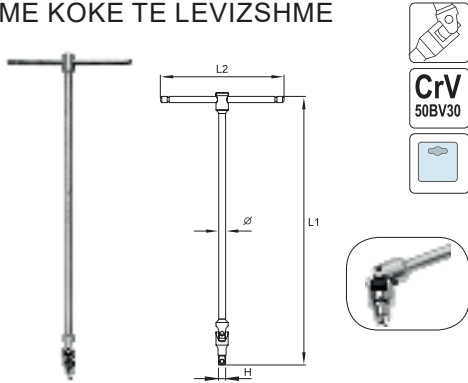

Kodi	H [mm]	L1 [mm]	L2 [mm]	Çmimi
YT-15291	1/4" (6.3mm)	450	180	<b>1.390</b>
YT-15292	3/8" (9.5 mm)	450	180	<b>1.390</b>
YT-15293	1/2" (12.7 mm)	450	180	<b>1.390</b>

### CELES PIPO I LEVIZSHEM TAF

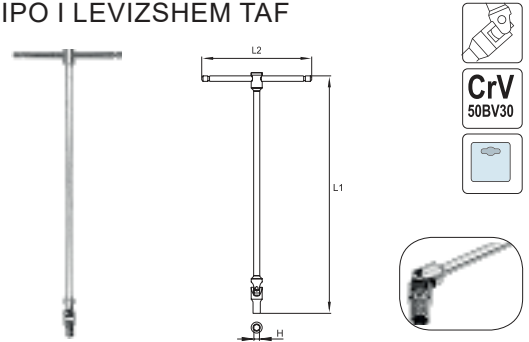

Kodi	H [mm]	L1 [mm]	L2 [mm]	Çmimi
YT-15275	10	450	180	<b>1.290</b>
YT-15278	13	450	180	<b>1.390</b>
YT-15282	17	450	180	<b>1.490</b>
YT-15284	19	450	180	<b>1.590</b>

### CELES KRIKET-KRIKET CRV



Kodi	Permasa [mm]	Çmimi
YT-4945	10x13x17x19 MM	<b>1.990</b>

### CELES FISO I CARE



Kodi	Permasa [mm]	Çmimi
YT-0136	11x12mm	<b>390</b>



### KOMPLET ME CELSA FISO-STEL KRIKET 7 COPE 10-19MM

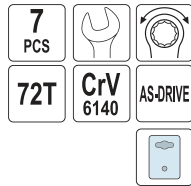

### SET ME 4 CELESA STEL-STEL

**IRI**



Kodi	Kapja	Çmimi
YT-0208	10, 12, 13, 14, 15, 17, 19	<b>3.500</b>

Kodi	Permasa [mm]	Çmimi
YT-0530	E6-E24	<b>1.950</b>

### KRYQ MAKINASH CR-V

**IRI**

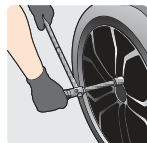

Kodi	Permasa [mm]	Çmimi
YT-0800	17x19x21x22	<b>1.390</b>

### LEVE KRIKETI T 3/4 CRV 500MM

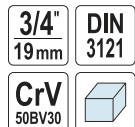
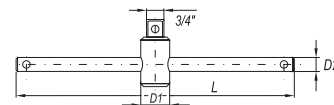

Kodi	Kapja	D1 [mm]	D2 [mm]	L [mm]	Çmimi
YT-1350	3/4"	37	20	500	<b>2.500</b>

### ZGJATUES KRIKETI FLEKSIBEL

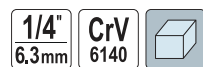

**IRI**



Kodi	Permasa	D [mm]	L1 [mm]	Çmimi
YT-1400	1/4" (6.3 mm)	11.7	300	<b>250</b>

### LEVE KRIKETI L

**IRI**

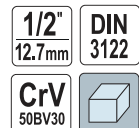
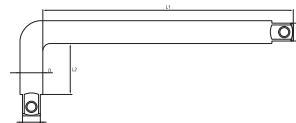

Kodi	Permasa	D [mm]	L1 [mm]	L2 [mm]	Çmimi
YT-12439	1/2" (12.7 mm)	16	282	55	<b>750</b>

LEVE KRIKETI L

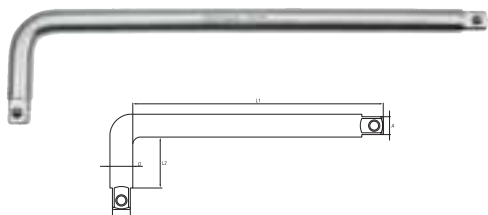

Kodi	Permasa	D [mm]	L1 [mm]	L2 [mm]	Çmimi
YT-13475	3/4" (19.0 mm)	25	373	75	<b>2.500</b>

LEVE KRIKETI L

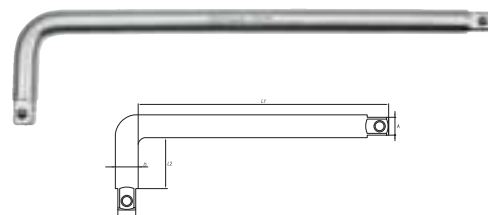
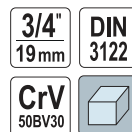

Kodi	Permasa	D [mm]	L1 [mm]	L2 [mm]	Çmimi
YT-13490	3/4" (19.0 mm)	25	578	75	<b>2.900</b>

LEVE KRIKETI 1/2" ME KOKE TE LEVIZSHME



Kodi	Permasa	Çmimi
YT-1243	255 mm	<b>550</b>

ZGJATUES PER KOKA KRIKETI 1/2" ZGJATUES KOK KRIKETI 1/2"



Kodi	Permasa	Çmimi
YT-1246	76 mm	<b>250</b>



Kodi	Permasa	Çmimi
YT-1248	254 mm	<b>550</b>

ZGJATUES PER KOKA KRIKETI 1/2" KOKE TE RRUMBULLAKET



Kodi	Permasa	Çmimi
YT-1249	76 mm	<b>350</b>

ZGJATUES FLEKSIBEL PER MAJA 1/4"



Kodi	Permasa	Çmimi
YT-14001	300 mm	<b>450</b>

ZGJATUES KRIKETI 1/4"



Kodi	Permasa	Çmimi
YT-1429	51 mm	<b>80</b>
YT-1431	102 mm	<b>120</b>
YT-1432	152 mm	<b>150</b>

DOREZE KRIKETI T 3/8"



Kodi	Permasa	Çmimi
YT-3840	198 mm	<b>450</b>

ZGJATUES KRIKETI 3/8"



Kodi	Permasa	Çmimi
YT-3843	76 mm	<b>150</b>
YT-3845	254 mm	<b>390</b>

ADAPTOR 3/8"(F)X1/4"(M)



Kodi	Kapja	Çmimi
YT-3853	(M)	<b>99</b>

ZGJATUES KRIKETI 3/8" KOKE TE RRUMBULLAKET



Kodi	Permasa	Çmimi
YT-3849	254 mm	<b>450</b>

PIPO TORX 1/4"



Kodi	Permasa	Çmimi
YT-04304	T20 37 mm	<b>75</b>
YT-04305	T25 37 mm	<b>75</b>
YT-04306	T30 37 mm	<b>75</b>
YT-04307	T40 37 mm	<b>75</b>

PIPO TORX I GJATE 1/2"



Kodi	Permasa	Çmimi
YT-04313	T30 L55 mm	<b>190</b>
YT-04324	T40 100mm	<b>220</b>
YT-04326	T50 100mm	<b>220</b>
YT-04318	T60 55 mm	<b>220</b>

CELES HEXAGON L I GJATE



Kodi	Permasa	Çmimi
YT-05430	1.5 mm	<b>30</b>
YT-05431	2.0 mm	<b>35</b>
YT-05432	2.5 mm	<b>40</b>
YT-05433	3.0 mm	<b>45</b>
YT-05435	4.5 mm	<b>45</b>
YT-05436	5.0 mm	<b>50</b>
YT-05437	5.5 mm	<b>65</b>
YT-05438	6.0 mm	<b>90</b>
YT-05440	8.0 mm	<b>150</b>
YT-05441	9.0 mm	<b>220</b>
YT-05442	10 mm	<b>250</b>
YT-05443	12 mm	<b>390</b>
YT-05444	14 mm	<b>550</b>

CELES TORX L I GJATE



Kodi	Permasa	Çmimi
YT-05490	T6	<b>50</b>
YT-05491	T7	<b>50</b>
YT-05492	T8	<b>50</b>
YT-05513	T9	<b>60</b>

PIPO HEXAGON 1/2"



Kodi	Permasa	Çmimi
YT-04396	12mm L100mm	<b>290</b>



### ADAPTOR AJRI ME KOKE TE LEVIZSHME

**IRI**



1/2"  
12.7mm

CrMo

Kodi	Permasa [mm]	Çmimi
YT-1064	1/2" (12.7 mm)	<b>1.990</b>

### KOKE KRIKETI AJRI 1/2 "



Kodi	Permasa	Çmimi
YT-1039	19 mm	<b>390</b>

### ADAPTOR F-M

**IRI**



3/4"  
19mm

CrV  
50BV30

Kodi	Permasa [mm]	Çmimi
YT-11671	3/4" (19.0 mm) (F) 1/2" (12.7 mm) (M)	<b>590</b>

### KOKE KRIKETI BI-HEXAGON AJRI 1"



Kodi	Permasa	Çmimi
YT-11990	65 mm	<b>9.500</b>
YT-11995	80 mm	<b>14.900</b>
YT-11998	85 mm	<b>16.900</b>

### KOKE KRIKETI 1/2 ME 12 FAQE CRV

**IRI**



1/2"  
12.7mm

DIN  
3121

CrV  
50BV30

AS-DRIVE

Kodi	Permasa [mm]	Çmimi
YT-12930	8 mm	<b>350</b>
YT-12948	30 mm	<b>850</b>

### KOKE KRIKETI 1/4" ME 6 FAQE

**IRI**



1/4"  
6.3mm

CrV  
50BV30

AS-DRIVE

Kodi	Permasa [mm]	Çmimi
YT-14127	10 x 25 mm	<b>120</b>
YT-1421	10 x 50 mm	<b>120</b>

### SET ME 3 ADAPTORE AJRI ME KOKE TE LEVIZSHME

**IRI**



1/2"  
12.7mm

3/8"  
9.5mm

CrMo

3  
PCS

1/4"  
6.3mm

Kodi	Permasa [mm]	Çmimi
YT-10643	1/4" (6.3 mm), 3/8" (9.5 mm), 1/2" (12.7 mm)	<b>2.500</b>

### CELES FISO-STEL KRIKETI



6  
PCS

CrV

□ 3/8" (9.5 mm) (M) x 1/4" (6.3 mm) (F), 1/4" (6.3 mm) (M) x 3/8" (9.5 mm) (F), 3/8" (9.5 mm) (F) x 1/2" (12.7 mm) (M), 1/2" (12.7 mm) (F) x 3/8" (9.5 mm) (M), 3/4" (19.0 mm) (M) x 1/2" (12.7 mm) (F), 1/2" (12.7 mm) (M) x 3/4" (19.0 mm) (F)

Kodi	Permasa [mm]	Çmimi
YT-10671	10 mm	<b>1.590</b>

### SET ME 8 KOKA KRIKETI 1/4" ME VARJE



8  
PCS

1/4"  
6.3mm

CrV  
50BV30

AS-DRIVE

Kodi	Permasa [mm]	Çmimi
YT-14431	5.5-13 mm	<b>950</b>

**KOKE KRIKETI E SHKALLEZUAR**  
3/8,29-68,1/2,21-32,27-32

**IRI**



1/2"  
12.7 mm

**CrV**



Kodi	Perm. [mm]	Kapja	Çmimi
YT-03316	(12.7 mm)	1/2" Mashkull	<b>890</b>
YT-03317	(12.7 mm)	1/2" Femer	<b>990</b>

**CELES KRIKETI I SHKALLEZUAR**  
1/8-1/2"

**IRI**



Kodi	Permasa [mm]	Çmimi
YT-03318	1/2"	<b>990</b>

**SET ME DALTA PLASTIKE**



**11**  
PCS

NO  
SCRATCH  
BEZ  
ZARYSOWAN

NYLON



Kodi	Seti	Çmimi
YT-0844	11 cope	<b>1.690</b>

**SET ME 40 MAJA DHE SHLICA**

**IRI**

40  
PCS

21.8  
Nm  
(max.)

HRC  
58-62

AISI  
S2



Kodi	Seti	Çmimi
YT-0400	40 cope	<b>3.500</b>

**SET ME 42 MAJA DHE SHLICA**

42  
PCS

21.8  
Nm  
(max.)

HRC  
58-62

AISI  
S2



Kodi	Seti	Çmimi
YT-0420	42 maja	<b>4.600</b>

**PISKATORE**

**IRI**

SS302  
STAINLESS STEEL  
STAL NIERZEWNA

ANTI-MAGNETIC  
ANTY-MAGNETYCZNE

ACID PROOF  
KWASOOC.  
ODPORNOSC



Kodi	Permasa [mm]	Çmimi
YT-6916	140	<b>390</b>

**SET ME 9 KACAVIDA GREP ME MAJE TE KTHYER**

**IRI**

9  
PCS

162  
mm

240  
mm

40Cr



Kodi	Seti	Çmimi
YT-08426	9 cope	<b>1.750</b>

**SET ME 6 MINI PINCETA ME MAJE**

**IRI**

6  
PCS

240  
mm

40Cr

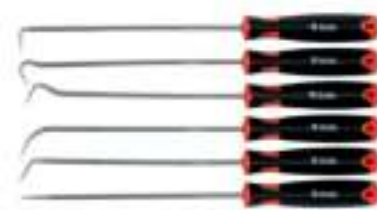

Kodi	Permasa [mm]	Çmimi
YT-08428	240	<b>990</b>

**SET ME 2 LEVA DORE GERRYESE**

**IRI**

2  
PCS

SS  
STAINLESS STEEL  
STAL NIERZEWNA



Kodi	Gjatesia [mm]	Çmimi
YT-52860	170x32x25, 235x40x- 40mm	<b>1.150</b>



**PINCE TELEFONI  
RJ45/10/11**

**IRI**

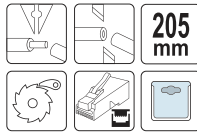

Kodi	E pershtatshme	Çmimi
YT-22443	RJ45, RJ11, RJ10, 8P, 6P, 4P	<b>1.990</b>

**PINCE TERMINALI  
KAPIKORDASH 0.2-6MM**



Kodi	Permasa	Çmimi
YT-2240	180 mm	<b>4.900</b>

**PINCE TERMINALI  
KAPIKORDASH**

**IRI**



Kodi	Permasa [mm]	Çmimi
YT-23051	175	<b>2.500</b>

**PINCE FLEKSIBEL PER FASHETA  
METALIKE 690MM**

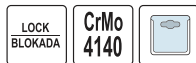

Kodi	Permasa	Çmimi
YT-0677	690 mm	<b>1.750</b>

**PINCE SHTRENGUESE PER  
TUBA**



Kodi	Modeli	Çmimi
YT-21735	PEX-AL-PEX	<b>17.900</b>

**PINCE SHTRENGUESE PER  
TUBA**



Kodi	Modeli	Çmimi
YT-21758	PEX U/TH16-32	<b>19.900</b>

**GERSHERE ELEKTRICISTI VDE**

**IRI**

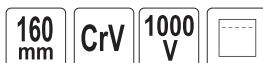

Kodi	Permasa [mm]	Çmimi
YT-21200	160	<b>2.900</b>

**GERSHERE TUBI PLASTIK  
ME TRUP ALUMINI V-CUT**

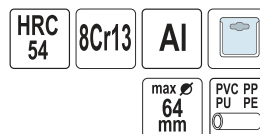

Kodi	Prerja max	Çmimi
YT-22293	64 mm	<b>2.790</b>

**GERSHERE MULTIFUNKSIONALE  
ME KEND 42.5-45-90° S2**

**IRI**

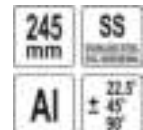

Kodi	Permasa [mm]	Çmimi
YT-18960	245	<b>2.590</b>



PINCE PER FASHO PISTONASH

IRI

40-100 mm



Kodi	Permasa [mm]	Çmimi
YT-06377	40-100 MM	<b>990</b>

PINCE PER FASHETA METALIKE

IRI

230 mm  
4mm  
ø12mm  
HRC 40  
LOCK BLOKADA



Kodi	Permasa [mm]	Çmimi
YT-0650	12 x 230 mm	<b>990</b>

STILOLAPS VAKUMI PER SALDIME

150 mm  
3.0 mm  
6.0 mm  
10 mm



Kodi	Permasa [mm]	Çmimi
YT-82514	150	<b>290</b>

POMPE PER MIKROSALDIM ELEKTRONIK

PTFE



Kodi	Permasa [mm]	Çmimi
YT-82742	19.5x190mm	<b>250</b>

POMPE PER MIKROSALDIM ELEKTRONIK

PTFE



Kodi	Permasa [mm]	Çmimi
YT-82743	21.8x206mm	<b>290</b>

POMPE PER MIKROSALDIM ELEKTRONIK

PTFE



Kodi	Permasa [mm]	Çmimi
YT-82744	30x330mm	<b>420</b>

MBAJTESE MAGNETIKE PER SALDIM E RRUMBULLAKET 500A



Kodi	Pesha	Çmimi
YT-08625	7kg	<b>1.350</b>

MINI TORCE ME GAS ME 0.2 KW RIMBUSHJE 13G/H

PIEZO 0.2 kW  
13.1 g/h  
GAS GAZ  
BUTANE BUTAN  
LIGHTER GAS GAZ DO ZAPALNICZEK  
LOCK BLOKADA  
CHILDREN PROTECTION ZABEZPECZENIE PRZED DZIECIAMI



Kodi	Fuqia	Konsumi	Çmimi
YT-36725	0.2kW	13.1 g/h	<b>1.790</b>

TORCE SALDIMI BRONZI ME QAFE TE GJATE 4 KW DHE 3 KOKA 13, 14, 17MM + TUB 1.5M

PROPANE BUTANE PROPAN BUTAN  
4 kW 288 g/h 360 mm  
x3 13/14/17 mm



Kodi	Konsumi	Çmimi
YT-36731	288 G/H	<b>2.990</b>

### TESTUES RRYME 12-1000V

**I RI**



155 mm	50/60 Hz
	12-1000V A.C.
CONTINUITY TEST TEST CİAĞLOŞCI	SENSITIVITY CZUŁOŚC
AUTO POWER OFF AUTOMATYCZNE WYŁĄCZANIE	LED LIGHT DIOD
LED LIGHTING OSWIELENIE	2x AAA

### TESTER VAJI FRENASH ME BATERI DHE DRITE LED

**I RI**



5 LED	1x AAA	
-------	--------	--

Kodi	Permasa [mm]	Çmimi
YT-28313	155	<b>1.390</b>

Kodi	Çmimi
YT-72982	<b>1.490</b>

### MULTIMETER DIGITAL AC / DC



CV	TRUE RMS	LCD 9999	
AUTO & MANUAL MODE TRYB REZYM AUTOMATYCZNY	0-750V A.C.	0-1000V D.C.	0-10 A A.C.
AUTO POWER OFF AUTOMATYCZNE WYŁĄCZANIE	0-10 A D.C.	0-99.99 MΩ	0-99.99 mF
DATA HOLD	0-9.999 MHz		1±99% °C - 20 + 1000
FRONT LIGHT LATARKA			

### MULTIMETER DIGITAL 200M



LCD 1999	0-500V A.C.
0-500V D.C.	0-5 A D.C.
0-2 MΩ	 5V P-P
hFE PNP NPN	
	9 V 6F22

Kodi	Tensioni	Çmimi
YT-73097	0-1000V	<b>7.500</b>

Kodi	Çmimi
YT-73080	<b>990</b>

### TESTER DIXHITA AC90-1000V ME DRITE



160 mm
90-1000V A.C.
SENSITIVITY CZUŁOŚC
ON / OFF
AUTO POWER OFF AUTOMATYCZNE WYŁĄCZANIE

### SKANUES MULTIFUNKSIONAL DIXHITAL CAN / DTC / OBD II



OBDII	DTC
CAN	LED DISPLAY WYŚWIETLACZ

Kodi	Permasa	Çmimi
YT-28310	162 mm	<b>990</b>

Kodi	Çmimi
YT-72977	<b>3.900</b>



### NIVELUES DIGITAL ME EKTRAN LED



Kodi	Permasa [mm]	Çmimi
YT-30395	150	<b>4.900</b>

### NIVELUES DIXHITAL ME 5 VIJA 20M



Kodi	Gjatesia e matjes	Çmimi
YT-30427	20 m	<b>9.900</b>

### NIVELUES DIXHITAL ME 2 VIJA JESHIL 10M +/- 3MM



Kodi	Gjatesia e matjes	Çmimi
YT-30434	10 m	<b>11.500</b>

### MATES LAGESHTIE LCD

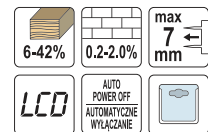

Kodi	Matja	Çmimi
YT-73140	0,2-42%	<b>3.500</b>

### KIT ME KABUJ TESTIMI



Kodi	Sasia	Çmimi
YT-73079	20 Cope	<b>2.200</b>

### KABELL STARTI 2.5M



Kodi	Amperazhi	Çmimi
YT-83152	400 A	<b>1.690</b>
YT-83153	600 A	<b>2.500</b>



### KARIKUES BATERIE DIXHITAL 6-12V

**IRI**

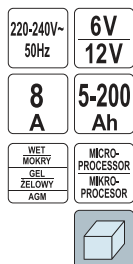

Kodi	Amperazhi [Ah]	Çmimi
YT-8301	8	<b>5.900</b>

### JUMP STARTER / POWER BANK 12000MAH/ 300-500A



Kodi	Amperazhi	Çmimi
YT-83082	300-500 A	<b>11.500</b>

### STARTER DHE KARIKUES BATERIE

**IRI**

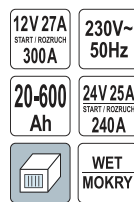

Kodi	Amperazhi [Ah]	Çmimi
YT-83060	20-600Ah	<b>27.900</b>

### TESTUES BATERIE 6 V / TESTUES BATERIE DIGITAL 12-24 V

**IRI**

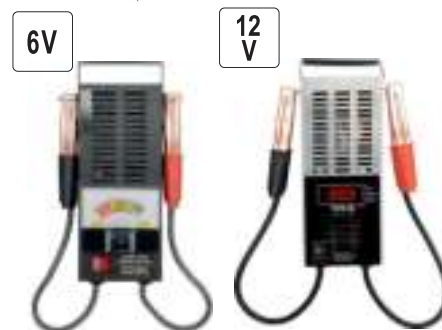

Kodi	Amperazhi [Ah]	Çmimi
YT-8310	200-2000	<b>3.500</b>
YT-8311	150-1500	<b>4.500</b>

### TESTUES ELEKTRONIK I BATERISE



Kodi	Bateria	Çmimi
YT-83113	12 V	<b>5.500</b>

### TESTER BATERIE 12V

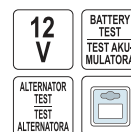

Kodi	Voltazhi	Çmimi
YT-83101	12 V	<b>1.290</b>

**PISTOLETE DADICEKESH 1/2"**  
ME QAFE TE SHKURTER



1/2" 12.7mm	TWIN HAMMER TYPE	0.63 MPa
165 l/min	680 Nm	10000 min <sup>-1</sup>
STANDARD		

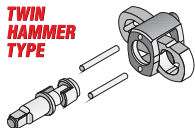

Kodi	Forca goditese	Kapja	Çmimi
YT-09513	680 Nm	1/2"	<b>13.500</b>

**PISTOLETE DADICEKESH 1/2"**  
1700NM, 7000RPM



1/2" 12.7mm	TWIN HAMMER TYPE	0.63 MPa
198 l/min	1700 Nm	7000 min <sup>-1</sup>
COMPOSITE BODY KOMPOZYTYWY KORPUS		STANDARD

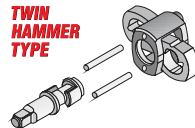

Kodi	Forca goditese	Kapja	Çmimi
YT-09544	1700 Nm	1/2"	<b>11.500</b>

**PISTOLETE DADICEKESH 3/4"**  
1300NM / 5000RPM



3/4" 19mm	TWIN HAMMER TYPE	0.63 MPa
660 l/min	1300 Nm	5000 min <sup>-1</sup>
G3/8		

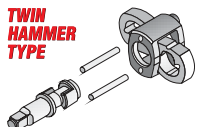

Kodi	Forca goditese	Kapja	Çmimi
YT-09564	1300 Nm	3/4"	<b>19.900</b>

**PISTOLETE DADICEKESH 1"**  
2600NM, 45MM, 4000RP/MIN



1" 25mm	PINLESS HAMMER TYPE	0.63 MPa
560 l/min	2600 Nm	4000 min <sup>-1</sup>
G1/2		

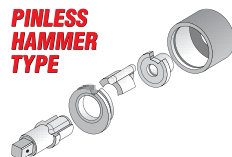

Kodi	Forca goditese	Kapja	Çmimi
YT-0960	2600 Nm	1"	<b>27.900</b>

**PISTOLETE DADICEKESH**  
5000 RPM



1" 25mm	PINLESS HAMMER TYPE	1.0 MPa
450 l/min	4800 Nm	5000 min <sup>-1</sup>
STANDARD		

**PINLESS  
HAMMER  
TYPE**

Kodi	Forca goditese	Kapja	Çmimi
YT-09618	4800 Nm	1"	<b>35.900</b>

**TRAPAN AJRI I DREJTE**  
MANDRINO 10MM



0.63 MPa	141 l/min	20000 min <sup>-1</sup>	max 10 mm
360° AIR EXHAUST WYDMUCH W POWIETRZA	SPEED REGULATOR REGULACJA PRĘDKOŚCI	0.66 kg	ULTRA LIGHT ULTRALEKKI
COMPOSITE BODY KOMPOZYTYWY KORPUS		STANDARD	

**ULTRA LIGHT**

Kodi	Rrotullimi	Presioni	Çmimi
YT-09695	20.000 rpm	0.63 mpa	<b>2.990</b>



PISTOLETE BOJE HVLP ME DEPOZITE PLASTIKE LART 600ML 1.5MM



0.3 MPa

410 l/min

1.5 mm

0.6L

HVLP

Kodi	Depozita	Koka	Çmimi
YT-2341	600 ml	1.5 mm	<b>3.500</b>

PISTOLETE BOJE AJRI



0.3 MPa

220 l/min

0.8 mm

0.1L

HVLP

Kodi	Depozita	Koka	Çmimi
YT-2357	100 ml	0.8 mm	<b>4.500</b>

GËRSHËRË PNEUMATIKE PËR PRERJE LLAMARINE



Kodi	Prerja max celik/alumin	Nr rrotulli-meve	Çmimi
YT-09945	1.2/1.4 mm	2500 rpm	<b>4.900</b>

ZMERILUESE RRETHORE METALIKE ME AJER



0.63 MPa

84 l/min

12000 min<sup>-1</sup>

150 mm

2.5 mm

360° AIR EXHAUST SYSTEM POWIERZCA

0.65 kg

ULTRA LIGHT ULTRALEKKI

STANDARD

STANDARD

Kodi	Diametri	Nr rrotulli-meve	Çmimi
YT-09738	150 mm	12000 rpm	<b>5.500</b>

PISTOLETE PASTRIMI AJRI ME MAJE TE HOLLE 0.8MPa



0.8 MPa (max)

110 mm

BRASS MOSIĄDZ

PP

STANDARD

STANDARD

Kodi	Gjatesia	Presioni	Çmimi
YT-23731	110 mm	0.8 MPa	<b>990</b>

PISTOLETE PER FRYRJE GOMASH ME MANOMETER DHE TUB



44 cm

AI

0.8 MPa (max)

STANDARD

STANDARD

Kodi	Gjatesia	Presioni	Çmimi
YT-2370	440 mm	0.8 MPa	<b>1.490</b>



KARRUKULL AJRI  
AUTOMATIKE 6.3 MM



Kodi	Gjatesia	Kapja	Çmimi
YT-24243	15 m	1/4"	<b>5.990</b>

KARRUKULL AJRI  
PROFESIONALE 9.5MM

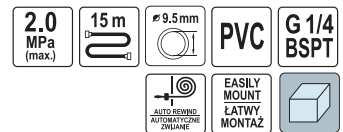

Kodi	Gjatesia	Kapja	Çmimi
YT-24250	15 m	3/8"	<b>13.500</b>

PISTOLETE AJRI PER FRYRJE  
GOMASH ME MANOMETER E  
DREJTE



Kodi	Permasa	Çmimi
YT-23703	1/4"	<b>2.900</b>

KARRIKULL AJRI AUTOMATIKE  
ME TUB



Kodi	Permasa	Çmimi
YT-24245	9.5mm x 15m	<b>9.900</b>

KARRIKULL AJRI AUTOMATIKE  
ME TUB



Kodi	Permasa	Çmimi
YT-24246	12.5mm x 15m	<b>12.500</b>

TUB AJRI UNIVERSAL PVC



Kodi	Permasa	Çmimi
YT-24220	8mm x 10m	<b>1.990</b>
YT-24224	10mm x 10m	<b>2.200</b>
YT-24225	10mm x 20m	<b>3.500</b>

TUB SPIRAL AJRI ME  
KAPJE UNIVERSALE



Kodi	Gjatesia	Diametri	Çmimi
YT-24204	5 m	6.5x10	<b>1.690</b>
YT-24207	5 m	8x12	<b>1.990</b>
YT-24208	10 m	8x12	<b>3.590</b>

KOKE UNIVERSALE 6 MM PER  
PISTOLETE FRYRJE GOMASH



Kodi	Permasa	Çmimi
YT-2371	6 mm	<b>350</b>

POMPE PRESIONI PER VAJ  
FRENASH



IRI

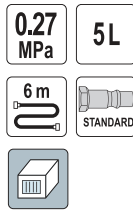

Kodi	Kapaciteti	Çmimi
YT-06845	100 l/min	<b>21.900</b>

POMPE GRASO PNEUMATIKE  
0.8 MPA

IRI



Kodi	Depozita	Çmimi
YT-07067	12 litra	<b>22.500</b>

PISTOLETE DADICEKESH ME  
QAFE TE SHKURTER 1/2"



Kodi	Permasa	Çmimi
YT-09512	678 mm	<b>14.900</b>

PISTOLETE DADICEKESH ME AJER 1/2"



Kodi	Shtrengimi	Çmimi
YT-09515	1200 Nm	<b>8.900</b>

MATRAPIK ME AJER 0.63MPA



Kodi	Presioni	Çmimi
YT-09904	0.63Mpa	<b>2790</b>

PERCINUESE ME AJER



IRI

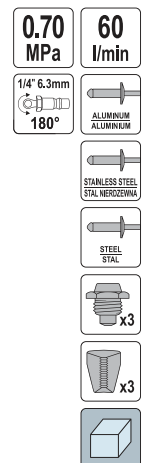

Kodi	Diametri	Çmimi
YT-36177	4.0-6.4 mm	<b>12.900</b>



TOLLUMBAC GOME PRESIONI  
PER PASTRIM PLUHRASH



QESE PRESIONI ME AJER PER  
HAPJE DYERSH

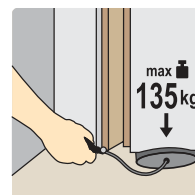

Kodi	Çmimi
YT-82512	<b>150</b>

Kodi	Permasa	Pesha max	Çmimi
YT-67380	150x160 mm	135 kg	<b>890</b>

STATIV MAGNETIK PER  
MAKINERI AJRI 15KG



KRIK ME ZINXHIR  
DHE BLOKUES



Kodi	Pesha mbajttese	Çmimi
YT-08707	15 kg	<b>2.990</b>

Kodi	Pesha	Zinxhiri	Çmimi
YT-58964	1.5 T	1.5 m	<b>14.900</b>

PISTOLETE PER FRYRJE  
GOMASH DIGJITALE 0.8MPa

**IRI**



POMPE PER NDARJE AJRI  
UNIVERSALE 1.3MPa



Kodi	Gjatesia [mm]	Çmimi
YT-23702	440	<b>2.990</b>

Kodi	Presioni	Çmimi
YT-23860	1.3 MPA	<b>6.500</b>



**NDRICUES MEKANIKU**  
30+7LED, 100LM ME MAGNET



Kodi	Bateria	Çmimi
YT-085051	3.7 V	<b>3.900</b>

**LLAMPE KOKE ME 3 BATERI AAA**



Kodi	Ndricimi	Çmimi
YT-08593	500 LM	<b>2.990</b>

**NDRICUES MEKANIKU LED**  
250LM, ME KARIKIM 3.7 & 12 V



Kodi	Intensiteti	Çmimi
YT-08504	250 lm	<b>3.990</b>

**NDRICUES MEKANIKU 5W+3W**  
600LM ME MAGNET



Kodi	Bateria	Çmimi
YT-08518	3.7 V	<b>5.900</b>

**LLAMPE KOKE 800 LM ME 3 BATERI AAA ME SENSOR**



Kodi	Bateria	Çmimi
YT-08594	800 LM	<b>3.900</b>

**ELEKTRIK DORE LED DHE LAMPE 3 NE 1 ME KARIKIM**



Kodi	Intensiteti	Çmimi
YT-08579	530 lm	<b>7.500</b>

**PROZHEKTOR LED ME SENSOR**



Kodi	Fuqia	Çmimi
YT-81826	10 W	<b>1.550</b>
YT-81828	30 W	<b>2.790</b>

**PROZHEKTOR KANTIERI LED**



Kodi	Fuqia	Çmimi
YT-81836	10 W	<b>1.590</b>
YT-818381	30 W	<b>2.990</b>
YT-818391	50 W	<b>3.500</b>

**LLAMPE KOKE E RREGULLUESHME**  
ME BATERI 3AAA, 3W, 100LM WATERPROOF



Kodi	Çmimi
YT-08590	<b>1.250</b>

**EKSTRATOSH SUSTASH**  
370MM, 1/2"

**2** PCS **1/2"** 12.7mm **21** mm   
COLD FORGED KUTE NA ZIMNO **CrV**



Kodi	Gjatesia	Sasia	Çmimi
YT-2544	370 mm	1/2"	<b>2.900</b>

**KIT RAPARIMI DINAMO**



Kodi	Paketimi	Çmimi
YT-04211	22 cope	<b>4.990</b>

**KIT PER DIAGNOSTIKIMIN E INJEKTORVE 6 CILINDRA**

**31** PCS  FOR 6 CYLINDERS DO 6 CYLINDROW



Kodi	Nr i provzave	Sasia	Çmimi
YT-7306	6	31 cope	<b>4.900</b>

**KOKE PER FILTRA KARBURANTI 1/2"**

**1/2"** 12.7mm **27** mm **CrV** FOR FUEL FILTER DO FILTRA PALWA 



Kodi	Permasa [mm]	Çmimi
YT-12000	27 mm	<b>650</b>



**SET ME 23 MAJA ME GODITJE PER VIDIATOR + ADAPTOR**



- ◆ 1/4" (6.3 mm) PH0, 2 x PH2, PH3 (L=25 mm); S2;
- ◆ 1/4" (6.3 mm) PZ0, 2 x PZ2, PZ3 (L=25 mm); S2;
- 1/4" (6.3 mm) 2 x T20, 2 x T25, 2 x T30, T40 (L=25 mm); S2;
- 1/4" (6.3 mm) 4, 5, 6 mm (L=25 mm); S2;
- ◆ 1/4" (6.3 mm) PH0 (L=50 mm); S2;
- ◆ 1/4" (6.3 mm) PZ2 (L=50 mm); S2;
- 1/4" (6.3 mm) T20, T30 (L=50 mm); S2;
- 1/4" (6.3 mm) T20, T30 (L=50 mm); S2;
- 1/4" (6.3 mm) L=60 mm; CV

Kodi	Seti	Çmimi
YT-04621	23 maja	<b>1.490</b>

**KIT PER HEQJEN E SENSOREVE 7 COPE**

**7** PCS **1/2"** 12.7mm **3/8"** 9.5mm **CrMo** SCM440   
**CrV** 50BV30 FOR OXYGEN SENSOR DO SONDY LAMBDA FOR FUEL INJECTORS DO INJEKTOROW PALWA 



- 1/2" (12.7 mm) x 29 mm; L=90 mm; 6PT
- 3/8" (9.5 mm) x 22 mm; L=90 mm; 6PT;
- 1/2" (12.7 mm) x 27 mm; L=78 mm; 12PT;
- 3/8" (9.5 mm) x 27 mm; L=74 mm; 6PT
- 3/8" (9.5 mm) x 22 mm; L=80 mm; 6PT;
- 1/2" (12.7 mm) x 22 mm; L=50 mm; 6PT;
- 3/8" (9.5 mm) x 22 mm; L=30 mm; 6PT

Kodi	Permasa	Çmimi
YT-1751	1/2" (12.7 mm), 3/8" (9.5 mm)	<b>4.900</b>



### KOMPLET ME KUPA METALIKE PER FILTRA VAJI 30 COPE

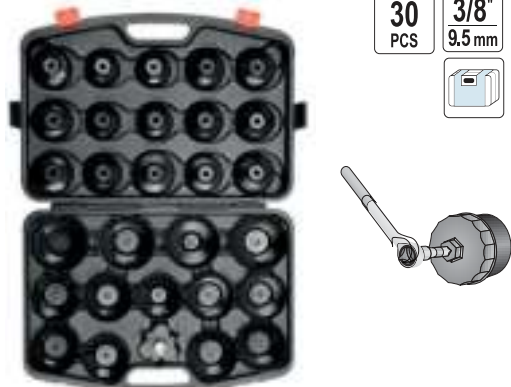

30  
PCS

3/8"  
9.5 mm

Kodi	Sasia	Çmimi
YT-0596	30	<b>9.900</b>

### SET PER VENDOSJEN E KUZHINETAVE DHE PERMISTOPAVE 10 COPE



Kodi	Permasa	Çmimi
YT-0638	40-81 MM	<b>4.900</b>

### KIT POMPE VAKUMI DORE ME 22 AKSESORE 1-3 BAR



22  
PCS

-1-3  
bar

Kodi	Presioni	Sasia	Çmimi
YT-0674	1-3 bar	22 cope	<b>5.990</b>

### KIT PER MATJE GAZI 6 COPE, 0-350PSI



6  
PCS

0-0.8  
MPa

0-3.4  
MPa

x3  
145 cm

R-134a

Kodi	Presioni	Sasia	Çmimi
YT-72990	0-350 PSI	6 cope	<b>8.900</b>

### KIT PER MATJE PRESIONI VAJI 0-500PSI 0-35BAR



12  
PCS

0-35  
bar

0-500  
psi

185cm

FOR ALL TYPES  
OF ENGINES  
DO WISZYSTYCH  
TYPOW SILNIKOW

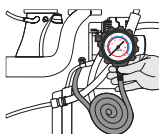

Kodi	Presioni	Sasia	Çmimi
YT-73030	500 PSI 0-35 BAR	12 cope	<b>2.900</b>

### KIT TESTIMI KOMPRESIONI PER MOTORRA NAFTE 19 COPE



16  
PCS

7.0  
MPa

FOR DIESEL  
ENGINES  
DO SILNIKOW  
DIESLA

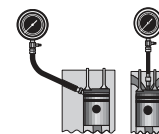

70 bar, 500 mm;  
160 mm;

M20x1.5: 75 mm; M22x1.5: 73 mm; M24x1.5: 88 mm; M24x2: 63 mm;  
M10x1: 83, 91, 102, 113, 119 mm; M10x1.25: 64, 135 mm;  
M12x1.25: 47 mm; M22x1.5: 118 mm;

Kodi	Presioni	Sasia	Çmimi
YT-7307	7.0 Mpa	19 cope	<b>6.500</b>



**KIT EKSTRATOR UNIVERSAL PER LIRIMIN E PISTONÇINAVE TE FRENAVE.**

**35** PCS **3/8"** **9.5 mm**

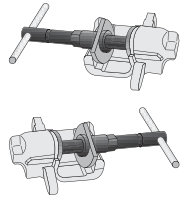

**REFRAKOMETER ME AKSESORE**



Kodi	Kapja	Sasia	Çmimi
YT-06822	3/8"	35 cope	<b>7.900</b>

Kodi	Aksesore	Temp. Max	Çmimi
YT-0672	14 koka	50 °C	<b>13.900</b>

**SET EKSTRATORESH UNIVERSAL PER LIRIMIN E KUZHINETAVE**

**31** PCS **38 mm** FOR BEARINGS AND BUSHINGS DOŁOZYSK (TULEJ)

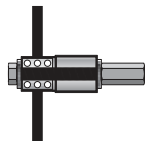

**SET PER LIRIMIN E DADICEKEVE TE KAMIONEVE**

**1"** **32 mm** **33 mm**  
**5800 Nm (max.)** **1:66** **CrV**



Kodi	Thellesia	Sasia	Çmimi
YT-25412	38 mm	31 cope	<b>11.500</b>

Kodi	Permasa	Tmax. [Nm]	Çmimi
YT-07822	1" (25.4 mm)	5800	<b>8.900</b>

**SET CELESASH FASHO DHE PINCE PER PISTONA 10 COPE**

**10** PCS **50-100 mm**

**IRI**



**KOMPLET ME 419 GOMINA TE RRUMBULLKTA 7MM-50MM**

**419** PCS **MIX** **NBR**



Kodi	Permasa [mm]	Çmimi
YT-06373	50-125, 60-175, 60-175	<b>6.500</b>

Kodi	Diametri	Sasia	Çmimi
YT-06876	7-50 mm	419 cope	<b>1.590</b>

SET ME 13 KUPA PER FILTRA VAJI



13  
PCS

3/8"  
9.5mm

1/2"  
12.7mm

65-120  
mm

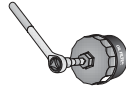

SET ME 5 MAJA PER VIDA TE PRISHURA



5  
PCS

1/4"  
6.3 mm

HSS  
4241

Kodi	Permasa	Çmimi
YT-0594	3/8, 1/2 / 65-120mm 10mm / 12.5mm	<b>5.900</b>

Kodi	Permasa	Çmimi
YT-06035	0-6, 1-8, 2-10, 3-12, 4-14 mm	<b>990</b>

SET ME 5 EXTRATOR DHE ZGJATUES DORE DHE ME TRAPAN



5  
PCS

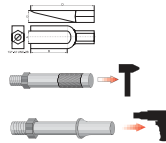

SET ME 7 INJEKTORA PRERES PER MOTORRA NAFTE



Kodi	Sasia	Çmimi
YT-0616	5 cope	<b>4.900</b>

Kodi	Injektore	Çmimi
YT-17625	7 Cope	<b>3.900</b>

SET ME 22 AKSESORE PER INJEKTORE NAFTE

**I RI**

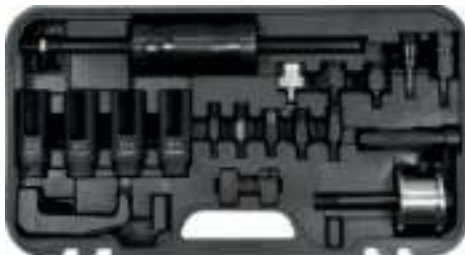

22  
PCS

1/2"  
12.7mm

BOSCH  
DELPHI  
DENSO  
SIEMENS

PUMP DUSE  
DIESEL  
INJECTORS  
POMPY  
WTRYSKMACZY

2  
HAMMERS  
MLOTY

KIT UNIVERSAL PER LIRIMIN E PISTONCINAVE TE FRENAVE

18  
PCS

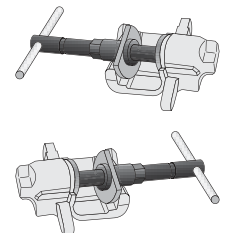
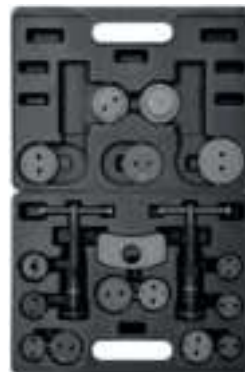

Kodi	Kapja	Sasia	Çmimi
YT-06175	1/2"	22 cope	<b>14.900</b>

Kodi	Sasia	Çmimi
YT-0682	18 cope	<b>3.500</b>



SET ME 7 AKSESORE PER CILINDRA



Kodi	Seti	Çmimi
YT-05801	7 aksesore	<b>5.500</b>

PINCE FASHETASH MAKINE



Kodi	Permasa	Çmimi
YT-0606	235 mm	<b>2.200</b>

EKSATOR REGJISTRUES UNIVERSAL



Kodi	Permasa	Çmimi
YT-06313	15~25mm	<b>950</b>

SET ME 28 ASORTIMENTE ELEKTRICISTI



Kodi	Seti	Çmimi
YT-06870	28 Aksesore	<b>790</b>

SET ME 28 AKESORE SINJALIZUES PER DEPOZITE UJI MAKINE



Kodi	Seti	Çmimi
YT-06721	28 Aksesore	<b>15.900</b>

PINCE GOMISTI



Kodi	Permasa	Çmimi
YT-0643	15~25mm	<b>1.790</b>

PISTOLETE THITHESE LENGJESH 500ML



Kodi	Vellimi	Çmimi
YT-07084	500 MI	<b>1.990</b>

SET ME 19 LEVA DHE PINCA TAPICERIE



Kodi	Seti	Çmimi
YT-08442	19 leva	<b>2.990</b>

VEGEL PER HEQJE FSHIRESESH XHAMASH MAKINASH



Kodi	Permasa	Çmimi
YT-0846	15~25mm	<b>520</b>

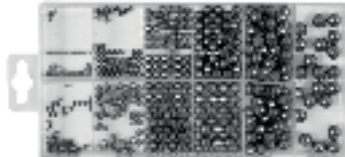

**SET ME 470 SFERA MIX**

Kodi	Seti	Çmimi
YT-06680	470 cope	<b>1.250</b>

**SET ME 60 KIAVETA**

Kodi	Seti	Çmimi
YT-06793	60 cope	<b>1.150</b>

**SET ME SIGURESA XHAMI**

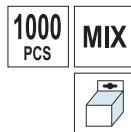

Kodi	Paketimi	Çmimi
YT-83130	120 cope	<b>850</b>

**SET ME 1000 KUNJA METALIKE**

Kodi	Paketimi	Çmimi
YT-06885	1000 cope	<b>1.150</b>

**SET ME 580 RONDELE BAKRI**

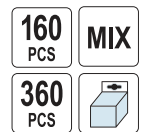
Kodi	Paketimi	Çmimi
YT-068711	580 cope	<b>5.500</b>

**SET ME KLEMA FUNDORE TERMINALI**

Kodi	Seti	Çmimi
YT-06890	360 cope	<b>2.490</b>
YT-06891	160 cope	<b>1.150</b>

**SET ME SIGURESA MAKINASH**

Kodi	Paketimi	Çmimi
YT-83140	24 cope	<b>1.250</b>

**SET ME SIGURESA MAKINASH**

Kodi	Paketimi	Çmimi
YT-83142	92 cope	<b>1.290</b>

**SET ME 120 SIGURESA MAKINASH MINI**



Kodi	Seti	Çmimi
YT-83146	120 cope	<b>1.150</b>

SET ME ASORTIMENTE  
ME IZOLUES TERMO  
SHTRENGUESE

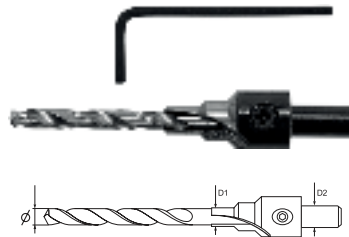

Kodi	Paketimi	Çmimi
YT-06867	171 cope	<b>990</b>
YT-06866	127 cope	<b>590</b>

PUNTO DRURI ME ADAPTOR  
DHE SHKALLE 4-6MM



Kodi	Permasa [mm]	Çmimi
YT-33023	7-10	<b>390</b>

SET ME 3 LAMA PER MAKINERI  
MULTIFUNKSIONALE

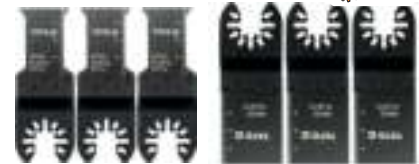
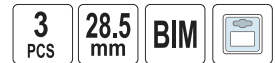

Kodi	Permasa [mm]	Çmimi
YT-34684	28.5 mm	<b>990</b>
YT-34685	34 mm	<b>650</b>

KUPE ZMERILIMI DIAMANTI  
M14



**IRI**



Kodi	Permasa [mm]	Çmimi
YT-60323	180	<b>3.500</b>

SET ME 3 LETRA PER ZMERILUESE  
MURESH



Kodi	Permasa	Çmimi
YT-846063	225 mm	<b>790</b>

DISK DRURI

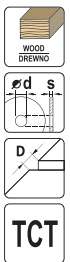

Kodi	Permasa [mm]	Çmimi
YT-6052	140X16TX20	<b>990</b>
YT-60522	140X30TX20	<b>1.150</b>
YT-60533	150X30TX20	<b>1.390</b>

DISK PARKETI

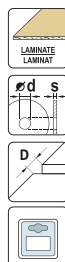

Kodi	Permasa [mm]	Çmimi
YT-60631	185X140TX20	<b>990</b>

SET ME 5 DISQE PRERES PER  
METAL

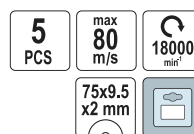

Kodi	Permasa [mm]	Çmimi
YT-0994	75 X 9.5 X 2 MM	<b>450</b>

DISK PASTRIMI ABRAZIV  
UNIVERSAL M14 P24

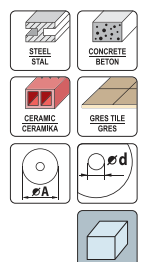

Kodi	Permasa [mm]	Çmimi
YT-83262	125 mm	<b>650</b>



**SET ME 3 LETRA ZMERILIMI  
225 MM**

x3 



Kodi	Paktimi	Çmimi
YT-845803	P60	<b>750</b>
YT-845813	P80	<b>750</b>
YT-845823	P100	<b>750</b>
YT-845833	P120	<b>750</b>
YT-845843	P60	<b>750</b>
YT-845853	P80	<b>750</b>
YT-845863	P100	<b>750</b>

**PUNTO DRURI E SHESHTE**



Kodi	Permasa	Çmimi
YT-3236	6 x 152 mm	<b>150</b>
YT-3237	8 x 152 mm	<b>150</b>
YT-3239	12 x 152 mm	<b>150</b>
YT-3240	13 x 152 mm	<b>150</b>
YT-3246	24 x 152 mm	<b>190</b>
YT-3247	25 x 152 mm	<b>190</b>

**SET ME 9 KOKA SHPIMI PER  
ELEKTRICISTA + ADAPTOR**



Kodi	Seti	Çmimi
YT-3380	9 Koka	<b>3.500</b>

**SET ME 4 FILTRA KARTONI  
PER ASPIRATOR**

4 PCS 



Kodi	Vellimi	Çmimi
YT-85732	24-30L	<b>850</b>

**PUNTO DRURI E SHESHTE**



Kodi	Permasa	Çmimi
YT-3248	26 x 152 mm	<b>230</b>
YT-3249	28 x 152 mm	<b>230</b>
YT-3252	34 x 152 mm	<b>230</b>
YT-3253	35 x 152 mm	<b>250</b>
YT-3254	38 x 152 mm	<b>260</b>
YT-3255	40 x 152 mm	<b>280</b>

**GJYSEM DISK DRU / METAL /  
PLASTIK PER MAKINERI  
MULTIFUNKSIONALE**



Kodi	Permasa	Çmimi
YT-34680	88 mm	<b>750</b>

**SHINE ME BAZAMENT  
MBESHETETES PER GURE  
FLEKSIBEL**

 115 mm  
 125 mm  
 90°/130mm  
45°/20mm  
CUTTING DEPTH  
SHEKONË E DEPTHTË  
 90°/130mm  
45°/60mm  
CUTTING LENGTH  
DEGJESË E DEPTHTË  



Kodi	Per elektrogure:	Çmimi
YT-82972	115-125 mm	<b>6.500</b>

**PUNTO FREZE**



 35 mm  
 YGB  
FOR METAL  

Kodi	Permasa	Çmimi
YT-33011	35 mm	<b>550</b>

**GJYSEM DISK PRERES  
UNIVERSAL PER MAKINERI  
MULTIFUNKSIONALE**



Kodi	Permasa	Çmimi
YT-34682	70 mm	<b>750</b>



LAME PRERESE PER MAKINERI MULTIFUNKSIONALE



Kodi	Permasa	Çmimi
YT-34686	20 mm	<b>490</b>

LAME PRERESE E SHKURTER PER MAKINERI MULTIFUNKSIONALE



Kodi	Permasa	Çmimi
YT-34688	52 mm	<b>290</b>

SET ME 3 TREKENDESHA ME NGJITJE PER MAKINERI MULTIFUNKSIONALE



Kodi	Seti	Çmimi
YT-34689	3 cope	<b>390</b>

SET ME 10 LETRA ZMERILIMI TREKENDESH PER MAKINERI MULTIFUNKSIONALE



Kodi	Seti	Çmimi
YT-34690	10 cope	<b>250</b>

SET ME 18 PUNTO UNIVERSAL ME KASE METALIKE



Kodi	Seti	Çmimi
YT-43490	18 cope	<b>1.750</b>

DALTE SDS-PLUS ME MAJE TE SHESHTE E ZEZE



Kodi	Permasa	Çmimi
YT-47212	80 mm	<b>1.450</b>

GOTE SHPIMI INOXI ME VIDIO



Kodi	Permasa	Çmimi
YT-44062	40 mm	<b>790</b>
YT-44064	45 mm	<b>890</b>
YT-44065	50 mm	<b>950</b>
YT-44068	55 mm	<b>990</b>
YT-44069	60 mm	<b>1.150</b>

GOTE SHPIMI INOXI ME VIDIO



Kodi	Permasa	Çmimi
YT-44070	65 mm	<b>1.250</b>
YT-44071	70 mm	<b>1.350</b>
YT-44072	80 mm	<b>1.550</b>
YT-44073	90 mm	<b>1.750</b>
YT-44074	102 mm	<b>1.950</b>

SET ME GOTE SHPIMI ME VIDIO 22-65MM



Kodi	Seti	Çmimi
YT-44077	6 cope	<b>4.900</b>

### TAMPON ZMERILIMI PER GURE FLEKSIBEL M14



Kodi	Permasa	Çmimi
YT-47860	75 mm	<b>440</b>

### GOMINE ME NGJITJE



Kodi	Permasa	Çmimi
YT-47872	125 mm	<b>520</b>
YT-47873	150 mm	<b>590</b>

### SFUNGJER ZMERILIMI PER POLIATRICE / LUCIDUESE



Kodi	Permasa	Çmimi
YT-47930	80 mm	<b>650</b>

### SFUNGJER ZMERILIMI PER POLIATRICE / LUCIDUESE



Kodi	Permasa	Çmimi
YT-47860	125 mm	<b>1.250</b>
YT-47932	150 mm	<b>1.790</b>
YT-47933	180 mm	<b>1.790</b>

### DISK PASTRIMI PER MERMER ME DIAMANT 100MM



Kodi	Pesha	Çmimi
YT-48202	GR.200	<b>590</b>
YT-48203	GR.400	<b>590</b>
YT-48204	GR.800	<b>590</b>
YT-48205	GR.1500	<b>590</b>
YT-48206	GR.3000	<b>590</b>

### DISK DIAMANTI 115X1.6MM QERAMIK



Kodi	Permasa	Çmimi
YT-59971	115 x 1.6 mm	<b>1290</b>
YT-59972	125 x 1.6 mm	<b>1390</b>

### DISK DIAMANTI TURBO PER PLLAKA PORCELANI



Kodi	Permasa	Çmimi
YT-59981	115 mm	<b>1.390</b>
YT-59982	125 mm	<b>1.450</b>

### PUNTO DIAMANTI PER PLLAKA PORCELAN DHE QERAMIKE



Kodi	Permasa	Çmimi
YT-60421	5 mm	<b>350</b>
YT-60422	6 mm	<b>350</b>
YT-60423	8 mm	<b>380</b>
YT-60424	10 mm	<b>450</b>
YT-60425	12 mm	<b>490</b>
YT-60426	14 mm	<b>590</b>

### PUNTO DIAMANTI PER PLLAKA PORCELAN DHE QERAMIKE



Kodi	Permasa	Çmimi
YT-60427	16 mm	<b>650</b>
YT-60428	20 mm	<b>790</b>
YT-60429	25 mm	<b>950</b>
YT-60433	68 mm	<b>2.990</b>
YT-60434	80 mm	<b>3.500</b>
YT-60436	125 mm	<b>5.900</b>



PUNTO DIAMANTI PORCELANI PER GURE FLEKSIBEL



Kodi	Permasa	Çmimi
YT-60442	8 mm	<b>1.750</b>
YT-60444	20 mm	<b>1.990</b>
YT-60446	51mm	<b>3.500</b>

DISK PRERES METALI



Kodi	Permasa	Çmimi
YT-61025	125x1x22.2mm	<b>69</b>

KOKE ZMERILIMI CILINDRIKE PER METAL



Kodi	Permasa	Çmimi
YT-61702	12 mm	<b>190</b>

PUNTO FREZE ZMERILUESE PER METAL



Kodi	Permasa	Çmimi
YT-61719	6 mm	<b>250</b>

KOKE ZMERILIMI DIAMANTI KONIKE



Kodi	Permasa	Çmimi
YT-61724	58.1 mm	<b>850</b>

PUNTO ZMERILIMI METALI E RRUMBULLAKE



Kodi	Permasa	Çmimi
YT-61725	6 x 45mm	<b>850</b>

KOKE ZMERILIMI DIAMANTI KONIKE



Kodi	Permasa	Çmimi
YT-61726	10 mm	<b>850</b>

KOKE ZMERILIMI DIAMANTI E RRUMULLAKET



Kodi	Permasa	Çmimi
YT-61727	50 mm	<b>850</b>

SET ME 6 KOKE ZMERILIMI DIAMANTIT



Kodi	Seti	Çmimi
YT-61729	6 cope	<b>3.990</b>



### KOKE ZMERILIMI KARBITI PREMIUM

**IRI**

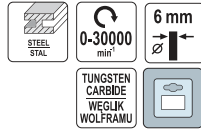

Kodi	Permasa [mm]	Çmimi
YT-61722	10x56	<b>990</b>

### KOKE ZMERILIMI KARBITI PREMIUM

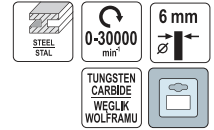

Kodi	Permasa [mm]	Çmimi
YT-61723	10x56	<b>990</b>

### PUNTO DIAMANTI PLLAKASH PORCELANI DHE QERAMIKE PROFI

**IRI**



Kodi	Dia	Nr i xhirove	Çmimi
YT-60401	6	1500 rpm	<b>1.200</b>
YT-60402	8	1500 rpm	<b>1.300</b>
YT-60403	10	1500 rpm	<b>1.400</b>

### PUNTO QERAMIKE DHE PORCELANI PROFI

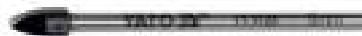

Kodi	Diametri	Çmimi
YT-3726	6	<b>290</b>
YT-3727	8	<b>390</b>
YT-3728	10	<b>390</b>

### PUNTO KONIKE TITAN

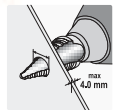

Kodi	Nivelet	Ø [mm]	Çmimi
YT-44741	10	4-22	<b>650</b>
YT-44740	12	6-38	<b>1.850</b>

### SET ME 3 PUNTO KONIKE

**IRI**

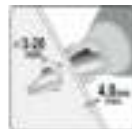

Kodi	Diametri	Çmimi
YT-44731	3-12 (3, 4, 5, 6, 7, 8, 9, 10, 11, 12 mm), 4-12 (4, 6, 8, 10, 12 mm), 4-20 (4, 6, 8, 10, 12, 14, 16, 18, 20 mm)	<b>1.290</b>

### KOKORE SALDIMI ME FOTOELEMENTE AUTOMATIKE



Kodi	Permasa e xhamit	Çmimi
YT-73926	110x90 mm	<b>9.500</b>

**PISTOLETE SALDIMI KALLAJI ME 5 AKSESORE 180W**



180 W  
S2 20%  
WORKING MODE TRYB PRACY  
LED LIGHTING OŚWIETLENIE

LED

Kodi	Fuqia	[°C]	Çmimi
YT-8245	180 W	0-600	<b>2.990</b>

**KACAVIDE ME BATERI 3,6V**



39 PCS LED 3.6V

Kodi	Maja	Çmimi
YT-27930	39 cope	<b>4.900</b>

**AJERNGROHESE ME AKSESORE, 2 NIVELE SHPEJTESIE**



2000 W 2 SPEEDS 50°C

Kodi	Fuqia	Çmimi
YT-82294	2000 W	<b>2.690</b>

**POLIATRICE PER MERMER 1300W, 100MM, 400-2100RPM**



Kodi	Permasa	Çmimi
YT-82161	100 mm	<b>14.900</b>

**SHARRE SHIRIT**



220-240V~50Hz 1100 W  
0.7-2.4 m/s 14 TPI  
1140x12.7x0.6 mm 127 mm  
3 m

Kodi	Shiriti	Çmimi
YT-82185	1140x12.7x0.6mm	<b>26.900</b>

**LAME SHARRE RRETHORE PER SHARRE HEKURI 14TPI 1140MM BIM**



Kodi	Modeli	Çmimi
YT-82189	14 TPI	<b>1.900</b>

**ASPIRATOR PROFESIONAL ME SHKUNDJE MEKANIKE (HEPA)**



220-240V~50/60Hz 1600 W 30 L  
18 kPa WET AND DRY SUCHO I MOKRO BLOW FUNCTION FUNKCJA DMUCHAWY  
IPX4 5m 2000 W

Kodi	Depozita	Fuqia	Çmimi
YT-85715	30 lt	1600 W	<b>29.900</b>

**FILTER HEPA**



Kodi	E pershtatshme per:	Çmimi
YT-85739	YT-85710	<b>1.590</b>



EXTRATOR PLUHRASH ME  
KEND PER TRAPAN/MATRAPIK



Kodi	Diametri	Çmimi
YT-82980	26-39 mm	<b>1.900</b>

EXTRATOR PLUHRASH PER  
GURE FLEKSIBEL 125MM



Kodi	Diametri	Çmimi
YT-82994	28-36 mm	<b>3.500</b>

ADAPTOR MAGNETIK

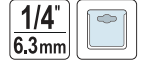

Kodi	Permasa [mm]	l [mm]	Çmimi
YT-0466	1/4 6.3 mm	60	<b>290</b>

ADAPTOR PER MAJA QUICK

**I RI**



Kodi	Permasa [mm]	Çmimi
YT-04695	1/4 x 150mm	<b>450</b>

ADAPTOR MAJASH I GJATE 1/4



Kodi	Permasa	Çmimi
YT-04682	200mm	<b>350</b>

ADAPTOR PER MAJA I GJATE

**I RI**



Kodi	Permasa [mm]	Çmimi
YT-04684	1/4 X 300 MM	<b>450</b>

ADAPTOR QUICK 1/2" M  
- 1/4" F 50 MM

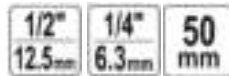

**I RI**



Kodi	Permasa	Çmimi
YT-04691	1/4" (6.3 mm)	<b>490</b>

ADAPTOR SDS-MAX M'  
X SDS-PLUS F"

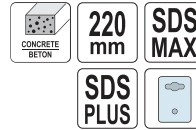

Kodi	Permasa	Çmimi
YT-41926	220 mm	<b>2.500</b>

ADAPTOR SDS-PLUS 60  
MM 1/4" ME MAGNET



Kodi	Permasa	Çmimi
YT-04690	60	<b>150</b>



**MBAJTES MAJASH 1/4 ME KEND**

**IRI**

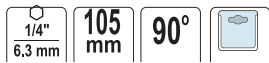

Kodi	Permasa [mm]	l [mm]	Çmimi
YT-04630	1/4 6.3 mm	105	<b>290</b>

**ADAPTOR MAGNETIK 1/4 ME MBROJTJESE PLASTIKE**

**IRI**



Kodi	Permasa [mm]	l [mm]	Çmimi
YT-0467	1/4 6.3 mm	80	<b>290</b>

**ADAPTOR MAGNETIK QUICK**

**IRI**

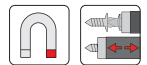

Kodi	Permasa [mm]	l [mm]	Çmimi
YT-0468	1/4 6.3 mm	60	<b>290</b>

**ADAPTOR MAGNETIK**

**IRI**



Kodi	Permasa [mm]	l [mm]	Çmimi
YT-0465	1/4 6.3 mm	60	<b>150</b>

**MAJE TORX S2**



Kodi	Permasa [mm]	l [mm]	Çmimi
YT-04051	T30	30	<b>95</b>
YT-0406	T40	30	<b>95</b>

**ADAPTOR MAJASH PER TRAPAN ME KEND**

**IRI**



Kodi	Permasa [mm]	l [mm]	Çmimi
YT-04632	1/4 6.3 mm	37	<b>650</b>

**ADAPTOR PER TRAPAN ME KOKE MANDRINO METALIKE**

**IRI**

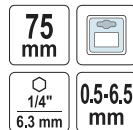

Kodi	Permasa [mm]	Çmimi
YT-04645	1/4 75 mm	<b>990</b>

**SET ME 50 KUNJA BRONZI PER FREZA**

**IRI**



Kodi	Seti	Çmimi
YT-06787	50 cope	<b>1.990</b>

**SET ME 56 KUNJA FREZASH METALIKE**

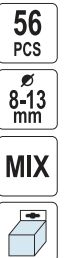

Kodi	Seti	Çmimi
YT-06874	56 cope	<b>2.500</b>

**IZOLANT RROBE I ZI**

Kodi	Permasa [mm]	Çmimi
YT-81500	19 mm X 15 m	<b>190</b>
YT-81501	19 mm X 25 m	<b>350</b>

**SET ME 10 IZOLANT ELEKTRIK MIX**

Kodi	Permasa	Çmimi
YT-8156	12 mm x 10m	<b>550</b>

**IZOLANT ELEKTRIK I VERDHE/ JESHILE**



Kodi	Permasa	Çmimi
YT-81593	15 mm x 10m	<b>129</b>

**IZOLANT ELEKTRIK I VERDHE/ JESHILE**

Kodi	Permasa	Çmimi
YT-81655	19 mm x 20m	<b>150</b>

**SONDE ZHBLOKIMI TUBASH PER TRAPAN**

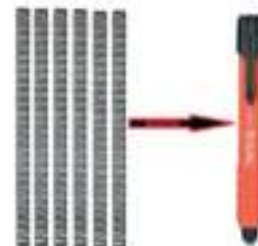
Kodi	Gjatesia	Gjeresia	Çmimi
YT-24990	6 m	6.0 mm	<b>1.900</b>

**MUNICIONE PER STILOLAPS INJEKSIONI**

Kodi	Sasia	Çmimi
YT-69285	6 cope	<b>180</b>

**SET ME 30 AKSESORE SHKRIRJE PER KABUJ**

Kodi	Permasa	Çmimi
YT-81441	0,5-1.5mm	<b>650</b>

**SET ME 30 AKSESORE SHKRIRJE PER KABUJ**

Kodi	Permasa	Çmimi
YT-81442	1.5-2.5mm	<b>690</b>

**SET ME 100 ASKESORE SHKRIRJE PER KABUJ**

Kodi	Permasa	Çmimi
YT-81453	1.5-2.5mm	<b>1.590</b>



**THIKE ME PALOSJE**

**IRI**



Kodi	Permasa [mm]	Çmimi
YT-76051	190 mm	<b>990</b>

**THIKE ME PALOSJE**

**IRI**



Kodi	Permasa [mm]	Çmimi
YT-76052	190 mm	<b>1.250</b>

**PISTOLETE PER FIKSIMIN E BADISCOPEVE 100MM**

**100 mm**

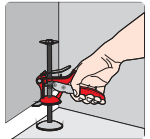

Kodi	Permasa	Çmimi
YT-37200	100 mm	<b>990</b>

**PRERESE PARKETI 210MM**

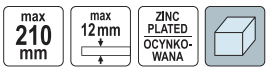

Kodi	Permasa	Çmimi
YT-37301	210 MM	<b>6.900</b>

**PRERESE PARKETI PROFESIONALE 13" 340MM**



Kodi	Permasa	Çmimi
YT-37311	340 mm	<b>19.900</b>

**PAJISJE PER POZICIONIM PARKETI 420MM**

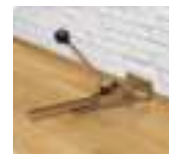

Kodi	Permasa	Çmimi
YT-37317	420 mm	<b>3.900</b>

**PAJISJE PER KONTURE KENDESH ME MAGNET**



Kodi	Permasa	Çmimi
YT-3735	125 mm	<b>690</b>
YT-3736	260 mm	<b>990</b>

**SQEPAR ME BISHT DRURI**



Kodi	Pesha [gr]	Çmimi
YT-80130	600	<b>990</b>

**BERDAF ME SFUNGJER DHE DOREZE GOME**



Kodi	Permasa	Çmimi
YT-51903	35 mm	<b>650</b>



NIVELUES TORPEDO ME  
EKTRAN LED



Kodi	Permasa	Çmimi
YT-30340	23 cm	<b>6.900</b>

NIVELUES ALUMINI ME 3  
FLLUSKA



Kodi	Permasa	Çmimi
YT-3001	40 cm	<b>690</b>

NIVELUES ALUMINI ME 3  
FLLUSKA



Kodi	Permasa	Çmimi
YT-3004	100 cm	<b>1.250</b>

SET ME 5 KACAVIDA  
ELEKTRIKE



Kodi	Seti	Çmimi
YT-2827	5 cope	<b>1.590</b>

SET ME 7 KACAVIDA  
ELEKTRIKE



Kodi	Seti	Çmimi
YT-2828	7 cope	<b>1.990</b>

DARE KARPENTIERI E  
VESHUR 8"



Kodi	Permasa	Çmimi
YT-2064	8"	<b>990</b>

MINI DARE E GOMUAR 115MM



Kodi	Permasa	Çmimi
YT-2082	115 mm	<b>490</b>

MINI PINCE E GOMUAR



Kodi	Permasa	Çmimi
YT-2080	115 mm	<b>490</b>

MINI TRONKEZE E GOMUAR



Kodi	Permasa	Çmimi
YT-2081	115 mm	<b>490</b>

PINCA FERMO ME HAPJE E DREJT

180 mm HRC 42-48 50 CrV



Kodi	Permasa	Çmimi
YT-2136	180 mm	<b>650</b>

PINCA FERMO ME MBYLLJE E DREJT

180 mm HRC 42-48 50 CrV



Kodi	Permasa	Çmimi
YT-2137	180 mm	<b>650</b>

PINCA FERMO ME HAPJE E KTHYER

180 mm HRC 42-48 50 CrV



Kodi	Permasa	Çmimi
YT-2138	180 mm	<b>650</b>

PINCA FERMO ME MBYLLJE E KTHYER

180 mm HRC 42-48 50 CrV



Kodi	Permasa	Çmimi
YT-2139	180 mm	<b>650</b>

PINCE FERMO PER HAPJE E DREJTE



Kodi	Permasa	Çmimi
YT-2140	150 mm	<b>490</b>

PINCE FERMO PER HAPJE E KTHYER



Kodi	Permasa	Çmimi
YT-2141	150 mm	<b>490</b>

PINCE FERMO PER MBYLLJE E DREJTE



Kodi	Permasa	Çmimi
YT-2142	150 mm	<b>490</b>

PINCE FERMO PER MBYLLJE E KTHYER



Kodi	Permasa	Çmimi
YT-2143	150 mm	<b>490</b>

SET KACAVIDE ME 22 MAJA TE GJATA



Kodi	Seti	Çmimi
YT-2797	22 maja	<b>4.900</b>

### VIZORE ALUMINI E RROTULLUESHME



Kodi	Gjatesia [mm]	Çmimi
YT-70791	600	<b>990</b>
YT-70792	1270	<b>2.500</b>

### SHENUS QENDRE



Kodi	Permasa [mm]	Çmimi
YT-47161	125	<b>550</b>

### GERSHERE ELEKTRICISTI 5.5"



Kodi	Permasa	Çmimi
YT-1974	142 mm	<b>590</b>

### VIZORE KENDESH ALUMINI

**IRI**



Kodi	Gjatesia [mm]	Çmimi
YT-70782	170	<b>1.690</b>
YT-70786	180	<b>1.900</b>

### SKUADER KENDESH

**IRI**



Kodi	Permasa	Çmimi
YT-7080	250 mm	<b>590</b>
YT-7081	300 mm	<b>690</b>
YT-7082	350 mm	<b>650</b>

### SKUADER METALIKE

**IRI**



Kodi	Permasa	Çmimi
YT-7083	150x300 mm	<b>750</b>
YT-7084	250x500 mm	<b>1.590</b>

### SKUADER TREKENDESH I PALOSSHEM

**IRI**



Kodi	Permasa [mm]	Çmimi
YT-70851	1720x1220x1220	<b>3.900</b>

### SKUADER ALUMINI 3D



Kodi	Permasa [mm]	Çmimi
YT-70825	150x70x215	<b>1.490</b>

### VIZORE KENDESH ME ZGJATIM

**IRI**



Kodi	Permasa [mm]	Çmimi
YT-70783	165x185x210-290	<b>2.990</b>



KAPSE TAPICERIE 3 FUNKSIONE



Kodi	Permasa	Çmimi
YT-70020	6 / 14 mm	<b>1.590</b>

THIKE TAPICERIE



Kodi	Permasa	Çmimi
YT-7505	18mm SK2	<b>150</b>

THIKE TAPICERIE ME GOMINE



Kodi	Permasa	Çmimi
YT-75071	6 / 14 mm	<b>190</b>

THIKE TAPICERIE ME GOMINE DHE MBROJTESE ALUMINI



Kodi	Permasa	Çmimi
YT-75121	18mm SK2	<b>450</b>

THIKE TAPICERIE



Kodi	Permasa	Çmimi
YT-75123	SK2H 18mm	<b>290</b>

SET ME 10 LAMA THIKE TAPICERIE REZERVE



Kodi	Permasa	Çmimi
YT-75129	SK5 18mm	<b>250</b>

SET ME 10 THIKA TAPICERIE SK2



Kodi	Permasa	Çmimi
YT-75262	25 mm	<b>450</b>

SET ME 15 CPUESE LEKURE



Kodi	Seti	Çmimi
YT-3591	15 cope	<b>2.500</b>

SET ME 3 FURCA PASTRIMI HEX PER TRAPAN



Kodi	Seti	Çmimi
YT-47553	3 cope	<b>890</b>
YT-47777	5 cope	<b>1.490</b>

GERSHERE TUBI PLASTIK



Kodi	Permasa	Çmimi
YT-2228	51 mm	<b>1.990</b>

PERCINUESE DORE



Kodi	Permasa	Çmimi
YT-36012	2.4 - 4.8 mm	<b>1.990</b>

PERCINUESE DORE PER RONDELE M3-6



Kodi	Permasa	Çmimi
YT-36140	M3-6	<b>3.500</b>

LIME DRURI E SHESHTE

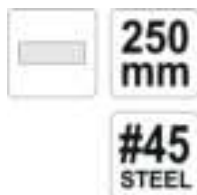

Kodi	Permasa	Çmimi
YT-6219	250 mm	<b>650</b>

LIME DRURI GJYSME E RRUMBULLAKËT

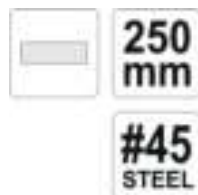

Kodi	Permasa	Çmimi
YT-6220	250 mm	<b>650</b>

LIME DRURI E RRUMBULLAKET



Kodi	Permasa	Çmimi
YT-6221	250 mm	<b>520</b>

VENTUZE TEKE ME VAKUM PROFESIONALE



Kodi	Diametri	Çmimi
YT-37220	204 mm	<b>7.990</b>

VENTUZE DOPIO ALUMINI PROFI



Kodi	Diametri	Çmimi
YT-37236	2x125 mm	<b>2.690</b>

VENTUZE TRESHE ALUMINI PROFI

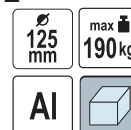

Kodi	Diametri	Çmimi
YT-37237	3x125 mm	<b>2.990</b>



METER ME GOMINE



Kodi	Permasa	Çmimi
YT-71070	3 m x 16 mm	<b>250</b>

METER ME GOMINE



Kodi	Permasa	Çmimi
YT-71071	5 m x 19 mm	<b>390</b>
YT-71072	5 m x 25 mm	<b>490</b>

METER ME GOMINE



Kodi	Permasa	Çmimi
YT-71073	8 m x 25 mm	<b>690</b>

METER I KUQ



Kodi	Permasa	Çmimi
YT-71151	3 m x 16 mm	<b>199</b>

METER I KUQ



Kodi	Permasa	Çmimi
YT-71153	5 m x 19 mm	<b>290</b>

METER I KUQ



Kodi	Permasa	Çmimi
YT-71155	7.5 m x 25 mm	<b>550</b>
YT-71156	10 m x 25 mm	<b>650</b>

PRERESE PLLAKASH  
PROFESIONALE



Kodi	Permasa	Çmimi
YT-37015	105 cm	<b>39.500</b>

PRERESE PLLAKASH  
PROFESIONALE



Kodi	Permasa	Çmimi
YT-37016	130 cm	<b>49.500</b>

PRERESE PLLAKASH  
PROFESIONALE



Kodi	Permasa	Çmimi
YT-37017	165 cm	<b>59.500</b>



MASKE PER MBROJTJE NGA PLUHURAT 2 COPE



Kodi	Modeli	Çmimi
YT-74852	FFP1/KZ	<b>290</b>

MASKE PER MBROJTJE NGA PLUHURAT ME VALVUL 3 COPF



Kodi	Modeli	Çmimi
YT-7486	FFP1/KZ	<b>490</b>

MASKE PER MBROJTJE NGA PLUHURAT 23 COPE



Kodi	Modeli	Çmimi
YT-74870	FFP1/KZ	<b>450</b>

MASKE PER MBROJTJE NGA PLUHURAT ME VALVUL 3 COPE



Kodi	Modeli	Çmimi
YT-7488	FFP1/PZ	<b>550</b>

MASKE PER MBROJTJE NGA PLUHURAT / KZ ME VALVUL 3 COPE



Kodi	Modeli	Çmimi
YT-74917	FFP1/KZ	<b>590</b>

MASKE PER MBROJTJE NGA PLUHURAT / 2 COPE



Kodi	Modeli	Çmimi
YT-74919	FFP1/P	<b>390</b>

MASKE PER MBROJTJE NGA PLUHURAT ME VALVUL 3 COPE



Kodi	Modeli	Çmimi
YT-7492	FFP1/PZ	<b>690</b>

SET ME 5 MASKA ME VALVULA



Kodi	Modeli	Çmimi
YT-749481	FFP2	<b>650</b>

MASKE PER MBROJTJE NGA PLUHURAT



Kodi	Modeli	Çmimi
YT-74949	FFP2/PZ	<b>290</b>

MASKE MBROJTJESE ME  
FILTER FFP1/KZ



Kodi	Çmimi
YT-74862	<b>190</b>

SET ME 5 MASKA



Kodi	Modeli	Çmimi
YT-74970	FFP1	<b>290</b>
YT-74971	FFP2	<b>350</b>
YT-74972	FFP3	<b>650</b>

SET ME 5 MASKA ME VALVULA



Kodi	Modeli	Çmimi
YT-74980	FFP1	<b>450</b>
YT-74981	FFP2	<b>490</b>
YT-74982	FFP3	<b>690</b>

KUFJE PER MBROJTJE NGA  
ZHURMAT



Kodi	Çmimi
YT-7462	<b>990</b>

KUFJE ME GOMINE PER  
MBROJTJE NGA ZHURMAT



Kodi	Çmimi
YT-74621	<b>850</b>

KUFJE PER MBROJTJE NGA  
ZHURMAT



Kodi	Modeli	Çmimi
YT-7463	SNR 5db	<b>590</b>

PANTALLONA PUNE  
PORTOKALLI 100 % POLIESTER



Kodi	Masa	Çmimi
YT-80957	L	<b>2.500</b>
YT-80958	XL	<b>2.500</b>
YT-80959	XXL	<b>2.500</b>

KOMINOSHE PUNE PORTOKALLI  
100 % POLIESTER

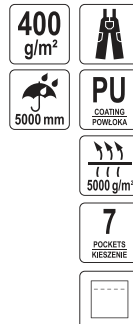

Kodi	Masa	Çmimi
YT-80962	L	<b>2.900</b>
YT-80963	XL	<b>2.900</b>
YT-80964	XXL	<b>2.900</b>

XHAKETE PUNE  
FOSFORESHENTE PORTOKALLI

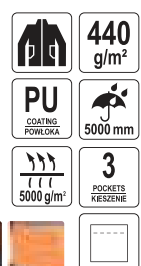

Kodi	Masa	Çmimi
YT-80952	L	<b>3.500</b>
YT-80953	XL	<b>3.500</b>



ÇORAPE 3 PALË - QAFE GJATE / SHKURTER



Kodi	Masa	Çmimi
YT-78340	39-42	<b>890</b>
YT-78341	43-46	<b>890</b>
YT-78342	39-42	<b>650</b>
YT-78343	43-46	<b>650</b>

DOREZE NITRILE TE VESHURA - ME VARJE



Kodi	Permasa	Çmimi
YT-74754	8"	<b>290</b>
YT-74755	9"	<b>290</b>
YT-74756	10"	<b>290</b>

DOREZA MBROJTJESE ME PREKJE EKRANI - ME VARJE



Kodi	Permasa	Çmimi
YT-74752	9"	<b>190</b>
YT-74753	10"	<b>190</b>

DOREZE NITRILE TE VESHURA



Kodi	Permasa	Çmimi
YT-74759	10"	<b>350</b>
YT-74757	8"	<b>350</b>
YT-74758	9"	<b>350</b>

DOREZA SALDIMI



Kodi	Permasa	Çmimi
YT-74645	10"	<b>490</b>

DOREZA PUNE ME POLIESTER GRI



Kodi	Permasa	Çmimi
YT-7472	10"	<b>150</b>
YT-74719	9"	<b>150</b>

DOREZA PUNE NITRILE TE BARDHA



Kodi	Permasa	Çmimi
YT-7474	10"	<b>150</b>
YT-74739	9"	<b>150</b>

DOREZA PUNE EXTRA ME VARJE TE ZEZA



Kodi	Permasa	Çmimi
YT-74728	8"	<b>150</b>
YT-74729	9"	<b>150</b>
YT-7473	10"	<b>150</b>

DOREZA PUNE ME POLIESTE/ NITRILE TE VERDHA



Kodi	Permasa	Çmimi
YT-7481	10"	<b>150</b>
YT-7480	9"	<b>150</b>



**DOREZA LEKURE ME VARJE**



Kodi	Masa	Çmimi
YT-74642	10" XL	<b>490</b>

**DOREZA PUNE PA GISHTA**



Kodi	Masa	Çmimi
YT-74661	9" L	<b>990</b>
YT-74662	10" XL	<b>990</b>

**SET MBAJTESE TAMPONESH VESHESH, SNR 38**



Kodi	Sasia	Çmimi
YT-74520	500 Cope	<b>5.500</b>

**DOREZA PUNE NAJLON ME VARJE**



Kodi	Masa	Çmimi
YT-7473	XL	<b>150</b>

**DOREZA PUNE PA GISHTA TE ZEZA**



Kodi	Masa	Çmimi
YT-74659	190 mm	<b>990</b>

**CANTE RROBE ME 16 XHEPA 40X23X21CM**



Kodi	Çmimi
YT-7433	<b>1.900</b>

**LITAR SIGURIMI**



Kodi	Permasa	Çmimi
YT-74225	1.8 M	<b>3.200</b>

**RRIPA SIGURIMI**



Kodi	Çmimi
YT-74221	<b>2.200</b>

**GJUNJEZA ME MBROJTESE PVC**



Kodi	Çmimi
YT-7461	<b>1.590</b>

SYZE MBROJTESE  
TRANSPARENTE UV



Kodi	Çmimi
YT-7360	<b>220</b>

SYZE MBROJTESE  
TRANSPARENTE



Kodi	Çmimi
YT-7371	<b>590</b>

SYZE MBROJTESE GRI



Kodi	Çmimi
YT-7376	<b>450</b>

SYZE MBROJTESE TRASPARENTE ME LLASTIK



Kodi	Çmimi
YT-7377	<b>990</b>

SYZE MBROJTESE  
TRANSPARENTE +3.0D



Kodi	Modeli	Çmimi
YT-73615	+3.0D	<b>390</b>

SYZE MBROJTESE  
TRANSPARENTE ME  
BISHT TE ZGJATUESHEM  
POLIKARBONAT



Kodi	Çmimi
YT-7363	<b>390</b>



SYZE MBROJTESE  
ME XHAM TE VERDHE  
POLIKARBONAT



Kodi	Çmimi
YT-7362	<b>290</b>



SHUALL KEPUCESH



Kodi	NR	Çmimi
YT-808702	40	<b>450</b>
YT-808703	41	<b>450</b>
YT-808704	42	<b>450</b>
YT-808705	43	<b>450</b>
YT-808706	44	<b>450</b>
YT-808707	45	<b>450</b>

KEPUCE LEKURE ME QAFE  
GORA S3 S



Kodi	NR	Çmimi
YT-80701	39	<b>4.900</b>
YT-80702	40	<b>4.900</b>
YT-80703	41	<b>4.900</b>
YT-80704	42	<b>4.900</b>
YT-80705	43	<b>4.900</b>
YT-80706	44	<b>4.900</b>
YT-80707	45	<b>4.900</b>



KEPUCE PUNE LEKURE ME QAFE TE SHKURTER ME MBROJTJE S3



Kodi	NR	Çmimi
YT-80583	39	<b>3.900</b>
YT-80584	40	<b>3.900</b>
YT-80585	41	<b>3.900</b>
YT-80586	42	<b>3.900</b>
YT-80587	43	<b>3.900</b>
YT-80588	44	<b>3.900</b>

KËPUÇË PUNE ME QAFE TË GJATE S1 S "TRAT"



Kodi	NR	Çmimi
YT-80733	39	<b>2.490</b>
YT-80734	40	<b>2.490</b>
YT-80735	41	<b>2.490</b>
YT-80736	42	<b>2.490</b>
YT-80737	43	<b>2.490</b>
YT-80738	44	<b>2.490</b>
YT-80739	45	<b>2.490</b>

KËPUÇË PUNE ME QAFE TË ULËT PUNO SB S



Kodi	NR	Çmimi
YT-80521	39	<b>2.690</b>
YT-80522	40	<b>2.690</b>
YT-80523	41	<b>2.690</b>
YT-80524	42	<b>2.690</b>
YT-80525	43	<b>2.690</b>
YT-80526	44	<b>2.690</b>
YT-80527	45	<b>2.690</b>

KEPUCE PUNE LEKURE PA QAFE ME MBROJTJE S1



Kodi	NR	Çmimi
YT-80463	39	<b>3.200</b>
YT-80464	40	<b>3.200</b>
YT-80465	41	<b>3.200</b>
YT-80466	42	<b>3.200</b>
YT-80467	43	<b>3.200</b>
YT-80468	44	<b>3.200</b>
YT-80469	45	<b>3.200</b>

KEPUCE SIGURIE SPORTIVE SBP S



Kodi	NR	Çmimi
YT-80641	39	<b>4.800</b>
YT-80642	40	<b>4.800</b>
YT-80643	41	<b>4.800</b>
YT-80644	42	<b>4.800</b>
YT-80645	43	<b>4.800</b>
YT-80646	44	<b>4.800</b>
YT-80647	45	<b>4.800</b>

KEPUCE SIGURIE SPORTIVE PUBS SBP S



Kodi	NR	Çmimi
YT-80620	39	<b>4.900</b>
YT-80621	40	<b>4.900</b>
YT-80622	41	<b>4.900</b>
YT-80623	42	<b>4.900</b>
YT-80624	43	<b>4.900</b>
YT-80625	44	<b>4.900</b>
YT-80626	45	<b>4.900</b>

PANTALLONA PUNE TE GJATA ANDESITE S



Kodi	Masa	Çmimi
YT-80906	S	<b>2.200</b>
YT-80907	M	<b>2.200</b>
YT-80908	L	<b>2.200</b>
YT-80910	XL	<b>2.200</b>
YT-80911	2XL	<b>2.200</b>

PANTALLONA PUNE TE GJATA DUERO S



Kodi	Masa	Çmimi
YT-8025	S	<b>2.390</b>
YT-8026	M	<b>2.390</b>
YT-8027	L	<b>2.390</b>
YT-8028	XL	<b>2.390</b>
YT-8029	2XL	<b>2.390</b>



PULOVER PUNE ME ZINXHIR E KUQE



Kodi	Masa	Çmimi
YT-79200	S	<b>2.500</b>
YT-79201	M	<b>2.500</b>
YT-79202	L	<b>2.500</b>
YT-79203	XL	<b>2.500</b>
YT-79204	2XL	<b>2.500</b>
YT-79205	3XL	<b>2.500</b>

PULOVER PUNE ME ZINXHIR DHE KAPUC E ZEZE OBSIDIAN S



Kodi	Masa	Çmimi
YT-79550	S	<b>2.990</b>
YT-79551	M	<b>2.990</b>
YT-79552	L	<b>2.990</b>
YT-79553	XL	<b>2.990</b>
YT-79554	2XL	<b>2.990</b>
YT-79555	3XL	<b>2.990</b>

XHAKETE PUNE STRATUS S



Kodi	Masa	Çmimi
YT-79560	S	<b>3.500</b>
YT-79561	M	<b>3.500</b>
YT-79562	L	<b>3.500</b>
YT-79563	XL	<b>3.500</b>
YT-79564	2XL	<b>3.500</b>
YT-79565	3XL	<b>3.500</b>

PULOVER PUNE ME ZINXHIR 420GSM HEAVY S



Kodi	Permasa	Çmimi
YT-79520	S	<b>3.200</b>
YT-79521	M	<b>3.200</b>
YT-79522	L	<b>3.200</b>
YT-79523	XL	<b>3.200</b>
YT-79524	2XL	<b>3.200</b>
YT-79525	3XL	<b>3.200</b>

XHAKETE PUNE NIMBOSTRATUS S



Kodi	Masa	Çmimi
YT-79540	S	<b>3.500</b>
YT-79541	M	<b>3.500</b>
YT-79542	L	<b>3.500</b>
YT-79543	XL	<b>3.500</b>
YT-79544	2XL	<b>3.500</b>
YT-79545	3XL	<b>3.500</b>

PULOVER ME KAPUC GRI LABRADOR S.



Kodi	Masa	Çmimi
YT-79210	S	<b>3.690</b>
YT-79211	M	<b>3.690</b>
YT-79212	L	<b>3.690</b>
YT-79213	XL	<b>3.690</b>
YT-79214	2XL	<b>3.690</b>
YT-79215	3XL	<b>3.690</b>

**KOMBINOSHE PUNE ANDESITE S**

Kodi	Masa	Çmimi
YT-80912	S	<b>2.900</b>
YT-80913	M	<b>2.900</b>
YT-80914	L	<b>2.900</b>
YT-80916	XL	<b>2.900</b>
YT-80917	2XL	<b>2.900</b>

**KOMBINOSHE PUNE DUERO S XHAKETE PUNE ANDESITE S**

Kodi	Masa	Çmimi
YT-8030	S	<b>2.990</b>
YT-8031	M	<b>2.990</b>
YT-8032	L	<b>2.990</b>
YT-8033	XL	<b>2.990</b>
YT-8034	2XL	<b>2.990</b>



Kodi	Masa	Çmimi
YT-80900	S	<b>2.790</b>
YT-80901	M	<b>2.790</b>
YT-80902	L	<b>2.790</b>
YT-80904	XL	<b>2.790</b>
YT-80905	2XL	<b>2.790</b>

**XHAKETE PUNE DUERO S**

Kodi	Masa	Çmimi
YT-8020	S	<b>2.900</b>
YT-8021	M	<b>2.900</b>
YT-8022	L	<b>2.900</b>
YT-8023	XL	<b>2.900</b>
YT-8024	2XL	<b>2.900</b>
YT-8025	3XL	<b>2.900</b>

**PANTALLONA PUNE TE SHKURTRA 100% PAMBUK**

Kodi	Masa	Çmimi
YT-80937	M	<b>2.500</b>
YT-80936	S	<b>2.500</b>
YT-80938	L ( 52 )	<b>2.500</b>
YT-80939	L / XL ( 54 )	<b>2.500</b>
YT-80940	XL	<b>2.500</b>
YT-80941	2XL	<b>2.500</b>

**PANTALLONA PUNE TE SHKURTRA 100% PAMBUK DORIA S**

Kodi	Masa	Çmimi
YT-80924	S	<b>1.990</b>
YT-80925	M	<b>1.990</b>
YT-80926	L	<b>1.990</b>
YT-80928	XL	<b>1.990</b>
YT-80929	2XL	<b>1.990</b>
YT-80930	3XL	<b>1.990</b>

Ekskluzive në

**BAUMARKET**



DOREZA ME VESHJE NITRILI  
FAMOUS GRI/ZEZE

DOREZA ME VESHJE NITRILI  
DORUS ZEZE/GRI

DOREZA ME VESHJE TE BUTE  
NITRILI RINO



Kodi	Permasa	Çmimi
16-303-001	Gri/zeze Nr 8"	<b>150</b>
16-303-002	Gri/zeze Nr 9"	<b>150</b>
16-303-003	Gri/zeze Nr 10"	<b>150</b>

Kodi	Permasa	Çmimi
16-330-001	Zeze/gri Nr 8"	<b>120</b>
16-330-002	Zeze/gri Nr 9"	<b>120</b>
16-330-003	Zeze/gri Nr 10"	<b>120</b>

Kodi	Permasa	Çmimi
16-303-871	Jeshile/zeze Nr 9"	<b>200</b>
16-303-872	Jeshile/zeze Nr 10'	<b>200</b>

DOREZA ME VESHJE LATEX  
RANORE BARI

DOREZA ELASTIKE ME VESHJE  
TE COPEZUAR LATEX CASOL

DOREZA ELASTIKE ME VESHJE  
LATEX DHE COPEZIME NAJLONI



Kodi	Permasa	Çmimi
16-330-122	Blu/Zeze Nr 9"	<b>250</b>
16-330-123	Gri/zeze Nr 10"	<b>250</b>

Kodi	Permasa	Çmimi
16-330-162	Jeshile/zeze Nr 9"	<b>220</b>
16-330-163	Jeshile/zeze Nr 10'	<b>220</b>

Kodi	Permasa	Çmimi
16-330-132	Kuqe/zeze Nr 9"	<b>250</b>
16-330-133	Kuqe/zeze Nr 10"	<b>250</b>



DOREZA ME VESHJE LATEX DHE COPEZIME NAJLONI RANORE VERSUS



Kodi	Permasa	Çmimi
16-330-153	Zeze/Jeshile Nr9"	<b>330</b>

DOREZA ME VESHJE PU TE NDERTHURUR



Kodi	Permasa	Çmimi
16-303-881	Gri Nr 9"	<b>120</b>
16-303-882	Gri Nr 10"	<b>120</b>

DOREZA ME VESHJE PU DHE COPEZIME NAJLONI



Kodi	Permasa	Çmimi
16-330-112	Blu/zeze Nr 9"	<b>250</b>
16-330-113	Blu/zeze Nr 10"	<b>249</b>

DOREZA ME VESHJE SHKUME LATEX DHE FIJE ELASTIKE LAND



Kodi	Permasa	Çmimi
16-303-802	Jeshile/mente 9"	<b>330</b>
16-303-803	Jeshile/mente	<b>330</b>

DOREZA ME VESHJE MIKROSH-KUME NITRILE ME PIKA



Kodi	Permasa	Çmimi
16-303-711	Gri/zeze Nr 9"	<b>490</b>
16-303-712	Gri/zeze Nr 10"	<b>490</b>

DOREZA ME VESHJE SHKUME NITRILI TE COPEZUAR FORTE



Kodi	Permasa	Çmimi
16-303-421	Gri/zeze Nr 9"	<b>350</b>
16-303-422	Gri/zeze Nr 10"	<b>350</b>

DOREZA ME VESHJE LATEX RANORE BARI DARK



Kodi	Permasa	Çmimi
16-303-781	Zeze Nr 9"	<b>390</b>
16-303-782	Zeze Nr 10"	<b>390</b>

DOREZA ME VESHJE TE PLOTE LATEX KUNDRA UJIT AQUA



Kodi	Permasa	Çmimi
16-303-960	Bojqielli/zeze Nr 8"	<b>350</b>
16-303-961	Bojqielli/zeze Nr 9"	<b>350</b>
16-303-962	Bojqielli/zeze Nr 10"	<b>350</b>

DOREZA ME VESHJE SUPERIORE LATEX TIGER



Kodi	Permasa	Çmimi
16-303-791	Bezhe/kaf Nr 9"	<b>390</b>
16-303-792	Bezhe/kaf Nr 10"	<b>390</b>

DOREZA LEKURE ME  
PELHURË PORTO



Kodi	Permasa	Çmimi
16-303-850	Kuqe/gri Nr 9"	<b>590</b>

DOREZA LEKURE ME  
PELHURË PORTO



Kodi	Permasa	Çmimi
16-303-851	Kuqe/gri Nr 10"	<b>590</b>

DOREZA LEKURE GRI DRIVER



Kodi	Permasa	Çmimi
16-303-861	Gri Nr 9"	<b>590</b>

DOREZA LEKURE GRI DRIVER



Kodi	Permasa	Çmimi
16-303-862	Gri Nr 10"	<b>590</b>

DOREZA LEKURE DHE PELHURE  
SINTETIKE LETO



Kodi	Permasa	Çmimi
16-303-890	Kuqe/gri Nr 10"	<b>290</b>

DOREZA LEKURE MOBILJESH  
PAVA



Kodi	Permasa	Çmimi
16-330-100	Blu/Zeze Nr 9"	<b>330</b>

## LETER PASTRIMI INDUSTRIALE



- \* Për pastrim të shpejtë të duarve, veglave, sipërfaqeve të punës etj..
- \* Largon pluhurin, papastërtitë, bojërat, yndyrat, ngjitësit etj..
- \* Nuk kërkohet ujë dhe sapun
- \* E thjeshtë dhe e shpejtë për t'u përdorur
- \* I përshtatshëm në shumë ambiente
- \* Shumë efektiv dhe kursen kohe
- \* Lehtë për tu ruajtur dhe transportuar
- \* 80 peceta të paketuara në kuti me vakum
- \* Mund të zvogëlojë rrezikun ndaj infeksioneve të mundshme virale
- \* Për punëtorët profesionistë dhe DIY

KODI:325.031

**Çmimi**

**990**



Ceresit



# FUQIA E NGJITJES

NE TE GJITHA KUSHTET



## ONE FOR ALL

Ekskluzive në

**BAUMARKET**



MADE IN  
GERMANY





# PARTNER I DESHMUAR PER TE GJITHA PUNET TUAJA



## Pattex PRO silikon Sanitar

Silikon me një perberes për mbylljen e fugave dhe carjeve në banjo, tualet dhe kuzhine. I përshtatshëm për qoshe, fuga, mur me dysheme, mur me mur dhe izolues për fugat e zgjerimit në dhoma me lageshti. Përmban substanca fungicide kështu që uji nuk qëndron në kyqe.

### KARAKTERISTIKAT

- Ngjitje e shkëlqyer
- Rezistent ndaj rrezatimit UV dhe kushteve të ndryshme të motit
- Rezistence e jashtëzakonshme ndaj kequrdhëve dhe sythave
- Rezistent ndaj ujit
- Për mbylljen e nujeve në banjo

Kodi	Pesha	Ngjyra	Cmimi
2921524	280 ml	Transparent	650
2921525	280 ml	Bardhe	650



## Pattex PRO silikon Universal

Silikon acetat për mbylljen e fugave në banje, kuzhine dhe kornizat e dritareve dhe dyerve. Një formulë silikoni që kombinon të gjithë performancën me të mirë të silikonit vetëm një produkt. Për përdorim të jashtëm dhe të brendshëm.

### KARAKTERISTIKAT

- Rezistent në të gjitha kushtet e motit
- Për brenda dhe jashtë
- Rezistent ndaj ujit
- Lehtë për tu aplikuar
- Për mbylljen e fugave

Kodi	Pesha	Ngjyra	Cmimi
2921243	280 ml	Transparent	590
2925565	280 ml	Bardhe	590



## Pattex PRO Akrilik Express

Silikoni i cili mund të lyhet dhe përdoret për mbylljen e fugave në mes mureve dhe dyerve, mureve dhe dritareve si dhe për mbushjen e zgavrave mes pllakave dhe paisjeve sanitare. I përshtatshëm për mbylljen e fugave në neshtrësë si betoni, tulla, kartoni, gipsi, alumini, druri dhe PVC.

### KARAKTERISTIKAT

- Silikon akrilik me tharje të shpejtë
- Për brenda dhe jashtë
- Mund të lyhet pas 10 minutash
- Lehtë për tu aplikuar

Kodi	Pesha	Ngjyra	Cmimi
2922706	280 ml	Bardhe	350



## Pattex PRO Silikon neutral

Silikon neutral i pershtatshem per mbylljen e qosheve dhe fugave te ekspozuara ndaj motit. Per PVC, dyer alumini dhe druri, korniza dritaresh, per fuga dhe ngjitje pllakash, per fuga tubash uji, kanale ventillimi, per mirembajtjen e varkave dhe karvaneve. Per perdorim te jashtem dhe te brendshem.

### KARAKTERISTIKAT

- Ngjitje e shkëlqyer ne shumicen e materialeve
- Pa okside dhe aroma te pakendshme
- Rezistent ndaj rrezeve UV
- Transparent

Kodi	Pesha	Ngjyra	Cmimi
2923728	280 ml	Transparent	990



## Pattex PRO Silikon rezistent ndaj temperatures se larte

Silikon mbylles ne baze te acidit acetik, i qendrueshem dhe fleksibel ne temperatura jashtzakonisht te larta deri ne 315 C per intervale te afatshkurtra.

### KARAKTERISTIKAT

- Rezistente ndaj temperaturave deri ne 260°C
- Per brenda dhe jashte
- Rezistent ndaj rrezatimit UV
- Mbetet pergjithmone elastik pas tharjes

Kodi	Pesha	Ngjyra	Cmimi
2928673	280 ml	Kuq	850



## Pattex PRO Silikon per xham dhe akvariume

Silikon izolues me nej perberes me baze acidi acetik. I pershtatshem per nenshtresa te ndryshme jo poroze si qelqi, pllaka qeramike, alumin dhe metal.

### KARAKTERISTIKAT

- Per perdorim te jashtem dhe brendshem
- Ngjitje e shkëlqyer ne siperfaqe jo absorbuese
- Rezistente ndaj rrezatimit UV dhe ndryshimeve te medha te temperaturave
- Pa tretes
- Per xham, akvariume dhe terrariume

Kodi	Pesha	Ngjyra	Cmimi
2933843	280 ml	Transparent	790



## LINJA E RE PATTEX SILIKONA PROFESIONAL

Kualitet Premium Henkel





**Pattex**

GUXONI TA BËNI



# 6 in 1

NGJITËS PU



## SHPEJTË!

Thuj "PO" kursimit të kohës!



## FUQISHËM!

Thuj "PO" ngjites!



## THJESHTË!

Thuj "PO" lehtësisë së aplikimit!



## PASTËR!

Thuj "PO" pastërtisë!







## Pattex 6 ne 1 Ngjites PU

Pattex 6ne1 është një ngjites poliuretani me një perberes me shumë qëllime efikasiteti të jashtëzakonshëm. Produkti ngjitet në mënyrë të përkryer në sipërfaqe të ndryshme dhe ka një mundësi të vogël mbushjeje gjë që e bën atë veqanërisht të përshtatshëm për sipërfaqe të pabarabarta. Mund të përdoret për materiale të ndryshme ndërtimi në të gjitha sipërfaqe, duke përfshirë ato të pabarabarta dhe të ndjeshme.

### KARAKTERISTIKAT

- Për ngjijtjen e blloqeve të ndërtimit në ndërtimin e mureve jo mbajtëse
- Për ngjijtjen e pllakave izoluese, pllakave të gipsit, elementeve dekorative
- Për mbulimin e kulmeve
- Për ngjijtjen e pragjeve të dritareve, për montimin e shkalleve

Kodi	Pesha	Ngjyra	Cmimi
2789293	750 ml	Verdhe	990



## Pattex PRO Presion te ulet

Pattex Pro me presion të ulet PU shkumë, është një shkumë me shtypje të ulet me një perberes për mbushje jashtëzakonisht të saktë. I përbahet fort të gjitha materialeve të zakonshme të ndërtimit dhe ka stabilitet të shkëlqyer dimensional.

### KARAKTERISTIKAT

- Shkumë për pistoletë
- Për mbushjen e boshleqeve për brenda dhe jashtë
- I shkëlqyeshëm për vendosjen e dyerve dhe dritareve
- Ngjitet edhe në sipërfaqe absorbuese
- Ideale për instalime të ndjeshme ndaj presionit
- Zgjerim jashtëzakonisht i ulet

Kodi	Pesha	Ngjyra	Cmimi
2789099	700 ml	Verdhe	890



## Pattex PRO Universal me pizez

Pattex Pro universal PU shkumë, është një shkumë universale me pizez me një perberes për mbyllje, mbushje, izolim dhe montim. Aplikim i shkëlqyer dhe i thjeshtë me pizez.

### KARAKTERISTIKAT

- Stabilitet i shkëlqyer
- Izolim i mirë i nxehtësisë dhe zërit
- Me perberes të ricikluar

Kodi	Pesha	Ngjyra	Cmimi
2789292	650 ml	Verdhe	790



## Pattex PRO Universal – me pistolette

Shkuma e pastër Pattex Pro Universal është një shkumë universale një komponenteshe, duhet të aplikohet me pistolette për aplikime të sakta dhe me matje. Shkumë poliuretani gjysmë fleksibel me një raport të jashtëzakonshëm të strukturae së qelizave të hapura dhe të mbyllura me forca të lartë mekanike. Zgjerimi i mëvonshëm dhe presioni i tharjes janë minimale duke rezultuar në doerezime të sakta gjatë përdorimit. Ngjijtje e shkëlqyer me materialet e ndërtimit si druri, betoni, grui, metali dhe të ngjajshme.

### KARAKTERISTIKAT

- Për mbushje, mbyllje, izolim dhe montim
- Dozim preciz
- Izolim i kornizave të dyerve dhe dritareve
- Mbushje e hendekut në mes të tubave

Kodi	Pesha	Ngjyra	Cmimi
2789291	700 ml	Verdhe	890

**Silikone Ceresit - partner i dëshmuar për përfundimin e punëve tuaja**

Nga bodrumi deri në çati.



## FT 101 FLEXTEC POLYMER

NGJIT - VULOS – PLOTËSON

**Silikon shumëfunktional - i bardhë, gri, kafe, i zi, transparent**

I bazuar në teknologjinë FLEXTEC. Është i përshtatshëm për nyje vertikale dhe horizontale, nyje fasadash, parvaze dritarësh, ulluqe, shkelëse të shkallëve, bazamente, dërrasa përfundimtare dhe mbuluese. Modul jashtëzakonisht i ulët i elasticitetit - për çarje që lëvizin.

### KARAKTERISTIKAT

- aderim i shkëlqyer me shumicën e materialeve\*
- izolim i lartë termik dhe akustik
- rezistencë ndaj lagështisë
- jetëgjatësi
- ekonomik - dozim i saktë
- për jashtë dhe brenda

\*Përveç për PE, PP, PTFE, PMMA dhe qelq akrilik.

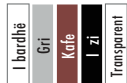

Kodi	Pesha	Ngjyra	Cmimi
2708041	280 ml	Transparent	950
2706088	280 ml	Bardhe	950
2708024	280 ml	Gri	950
1755222	280 ml	Zi	990
2708027	280 ml	Kaf	950



## SILIKON CS 28 THERMO RESISTANT CERESIT

Për mbylljen dhe ngjytjen në temperatura të larta, për tubat e furrave dhe ngrohjes qendrore, zjarrit, kondicionerëve, furrave, etj. Për mbylljen e nyjeve të ekspozuara ndaj temperaturave të larta. Ajo ngjitet mirë në shumicën e nënshtresave jo-absorbuese (p.sh. metali, qelqi, rrëshira silikoni, fibra qeramike, natyrore dhe sintetike).

### KARAKTERISTIKAT

- Rezistencë ndaj temperaturës së lartë nga -60°C në + 260°C (me intervale të shkurta deri në + 315 °C)
- I përshtatshëm për ndërtimin e oxhaqeve dhe kaminave
- Rezistent ndaj rrezatimit UV dhe kushtet e motit

- Përgjithësisht elastik
- Zhvillon një erë specifike kur thahet
- Për përdorim të brendshëm dhe të jashtëm

Kodi	Pesha	Ngjyra	Cmimi
2670127	300 ml	Thermo	890



260°



## Pattex RE-NEW Silikon i bardhë rinovues

Silikonit RE-NEW përmes një aplikimi të thjeshtë mundëson rinovimin e silikonit të vjetër pa e hequr atë paraprakisht.

### KARAKTERISTIKAT

- aplikim mbi silikonin ekzistues
- mbrojtje afatgjatë
- ngjytje e përsosur me silikonin ekzistues
- hundë precize, automatike
- rezistent ndaj mykut dhe kërpudhave
- pa përdorim pistolette për silikon
- koha minimale e tharjes 6h



Aplikues automatik



Rezistent ndaj mykut

Kodi	Pesha	Ngjyra	Cmimi
2766228	80 ml	Bardhe	790

## TS 61 UNIVERSAL - ME PIPEZ



Shkumë PU gjysëm fleksibël një komponentësh me strukturë të jashtëzakonshme qelizash të hapura dhe të mbyllura dhe forcë të lartë mekanike. Shkuma është vetë-zgjeruese dhe zgjerohet 2-2.5 herë gjatë procesit të ngurtësimit. Aplikohet për forcimin e kornizave të dritareve dhe dyerve, mbushjen e zgavrave, vulosjen e hapjeve në konstruksionet e çatisë, izolimin akustik, mbushjen e zgavrave rreth tubave dhe instalimin e tjegullave dhe pllakave të murit.

### KARAKTERISTIKAT

- ngjitje e shkëlqyer me shumicën e materialeve
- izolim i lartë termik dhe akustik
- i përshtatshëm për mbushjen e zgavrave
- rezistencë ndaj lagështisë
- jetëgjatësi
- të mbrohet nga rrezatimi UV!

Kodi	Pesha	Ngjyra	Cmimi
565006	750 ml	Verdhe	890

## TS 61 UNIVERSAL - ME PIPEZ



Shkumë PU gjysëm fleksibël një komponentësh me strukturë të jashtëzakonshme qelizash të hapura dhe të mbyllura dhe forcë të lartë mekanike. Shkuma është vetë-zgjeruese dhe zgjerohet 2-2.5 herë gjatë procesit të ngurtësimit. Aplikohet për forcimin e kornizave të dritareve dhe dyerve, mbushjen e zgavrave, vulosjen e hapjeve në konstruksionet e çatisë, izolimin akustik, mbushjen e zgavrave rreth tubave dhe instalimin e tjegullave dhe pllakave të murit.

### KARAKTERISTIKAT

- ngjitje e shkëlqyer me shumicën e materialeve
- izolim i lartë termik dhe akustik
- i përshtatshëm për mbushjen e zgavrave
- rezistencë ndaj lagështisë
- jetëgjatësi
- të mbrohet nga rrezatimi UV!

Kodi	Pesha	Ngjyra	Cmimi
576174	500 ml	Verdhe	650

## TS 62 PRO UNIVERSAL - ME PISTOLETË



Shkumë PU gjysëm fleksibël një komponentësh me strukturë të jashtëzakonshme qelizash të hapura dhe të mbyllura dhe forcë të lartë mekanike. Zgjerimi i mëvonshëm dhe presioni i ngurtësimit janë minimale, gjë që rezulton në saktësinë e dozimit gjatë përdorimit. Ngjitje e shkëlqyer në shumicën e materialeve të ndërtimit siç janë druri, betoni, guri, metali dhe të ngjashme.

### KARAKTERISTIKAT

- izolim i lartë termik dhe akustik
- rezistencë ndaj lagështisë
- i përshtatshëm për mbushjen e zgavrave në konstruksionet e çatisë dhe materialet izoluese
- dozim i saktë
- mbetje minimale për shkak të dozimit të saktë
- jetëgjatësi

Kodi	Pesha	Ngjyra	Cmimi
566516	750 ml	Verdhe	990

## TS 63 LOW EXPANSION Shkumë PU me zgjerim të ulët – ME PISTOLETË



Shkumë PU me pistoletë njëkomponentëshe e cila tkurret nën ndikimin e lagështisë. Zgjerimi i mëvonshëm dhe presioni i ngurtësimit janë minimale, gjë që rezulton në saktësinë e dozimit gjatë përdorimit. E përshtatshme me shumicën e materialeve të ndërtimit. Paketimi është i pajisur me një hundë të gjeneratës së re, e cila siguron një jetëgjatësi më të gjatë dhe cilësi më të gjatë të produktit.

### KARAKTERISTIKAT

- presion i ulët gjatë procesit të ngurtësimit
- stabilitet i shkëlqyer
  - pa tkurrje
  - zgjerim i ulët i mëpasshëm
- aplikim shumë i saktë
- dozim i saktë = konsum ekonomik
- veti të larta izoluese

Kodi	Pesha	Ngjyra	Cmimi
1624376	750 ml	Verdhe	890





## TS 70 MEGA - ME PISTOLETË

Shkumë PU njëkomponentëshe, e përshtatshme për forcimin e kornizave të dritareve dhe dyerve, mbushjen e zgavrave, vulosjen e hapjeve në konstruksionet e çatisë dhe materialet izoluese, izolimin akustik, mbushjen e zgavrave rreth tubave, forcimin e tjegullave dhe pllakave të murit.

### KARAKTERISTIKAT

- aderim i shkëlqyer në shumicën e materialeve
- izolim i lartë termik dhe akustik
- rezistent ndaj lagështisë
- jetëgjatësi
- ekonomik - dozim i saktë

Kodi	Pesha	Ngjyra	Cmimi
2350697	870 ml	Verdhe	1.200

## TS 100 PU CLEANER



TS 100 PU CLEANER është një tretës i veçantë me bazë acetoni për heqjen e njollave të freskëta, të pathara të shkumës PU, si dhe njollave të padëshiruara të ngjitësve ose bojërave nga sipërfaqet e lëmuara. Është i lehtë për përdorim dhe aplikim. Pastruesi ka veti të shkëlqyera pastrimi dhe konsiderohet jashtëzakonisht i rëndësishëm për pastrimin e menjëhershëm të pistoletave për aplikimin e shkumës PU nga jashtë dhe nga brenda pas përdorimit të tyre.

### KARAKTERISTIKAT

- Tretës i fuqishëm
- Vetë të shkëlqyera pastruese
- Tharje e shpejtë

Kodi	Pesha	Ngjyra	Cmimi
1435375	500 ml	Verdhe	790



**Pattex**

# GUXO DHE BËJE ME PATTEX

## NJE MARKE PER TE GJITHA ZGJIDHJET



Henkel

**Pattex**



**FORCË  
NGJITËSE  
NË TË GJITHA KUSHTET  
ONE FOR ALL**



A135

Henkel



## Fix Express Ngjitës montimi me bazë tretësi

Aplikimi:

- tulla
- qeramikë
- beton
- lesionit dhe pllaka gipsi
- karton
- guri
- pllaka MDF
- UPVC

KARAKTERISTIKAT

- përdoret për sipërfaqe absorbuese dhe jo absorbuese
- është rezistent ndaj ujit dhe kushteve të këqija klimatike
- aplikim i thjeshtë në temperatura të ulëta (-10°C)
- nuk ka nevojë për sigurimin e nyjeve me mjete për fiksion mekanik
- për përdorim të jashtëm dhe të brendshëm
- mundësi ngjyrosjeje kur thahet
- me erë të dobët



Kodi	Pesha	Ngjyra	Cmimi
2955396	375 gr	Verdhe	750
2960032	75 gr	Verdhe	390



## One For All HIGH TACK FLEXTEC polymer

ME BAZË POLIMERI MS

Aplikimi:

- tulla
- qeramikë
- beton
- pllaka gipsi
- karton
- guri
- mediapan
- PVC
- dru
- metal
- UPVC
- stiropor
- qelq
- plastikë
- sipërfaqet e lyera
- pasqyra\*

KARAKTERISTIKAT

- për të gjitha materialet dhe të gjitha kushtet
- për brenda dhe jashtë
- ngjit menjëherë
- ekstra i fortë
- rezistent ndaj të gjitha kushteve atmosferike



I BARDHË

\*Përdorni pasqyra në përputhje me DIN 1238, 5.1 dhe DIN EN 1036, kërkonte këshilla teknike për objekte me përmasa më të mëdha.

Kodi	Pesha	Ngjyra	Cmimi
2716398	440 gr	Bardhe	890



## One For All UNIVERSAL FLEXTEC polymer

ME BAZË POLIMERI MS

Aplikimi:

- dru
- tulla
- beton
- qeramikë
- guri
- metal
- qelq
- pasqyra
- stiropor
- pllaka gipsi
- sipërfaqe të thata dhe të lagura
- plastikë\*

KARAKTERISTIKAT

- për të gjitha llojet e materialeve\*
- për nënshtresa absorbuese dhe jo absorbuese
- për përdorim të brendshëm dhe të jashtëm
- për sipërfaqe të lagura dhe me lagështi
- rezistent ndaj kushteve të motit dhe rrezeve UV
- rezistent ndaj ujit
- nuk ka tkurrje
- fleksibilitet i jashtëzakonshëm
- rezistent ndaj goditjeve



I BARDHE

\*Nuk është i përshtatshëm për ngjitjen e materialeve të tilla si PE, PP, PTFE, qelqit akrilik, bakrit, tunxhit dhe PVC-së së butë.

Kodi	Pesha	Ngjyra	Cmimi
2690778	389 gr	Bardhe	850



## One For All CRYSTAL FLEXTEC polymer

ME BAZË POLIMERI MS

Aplikimi:

- dru
- tulla
- beton
- qeramikë
- guri
- metal
- qelq
- pasqyra
- stiropor
- pllaka gipsi
- sipërfaqe të thata dhe të lagura
- plastikë\*

KARAKTERISTIKAT

- për të gjitha llojet e materialeve\*
- për nënshtresa absorbuese dhe jo absorbuese
- për përdorim të brendshëm dhe të jashtëm
- për sipërfaqe të lagura dhe me lagështi
- rezistent ndaj kushteve të motit dhe rrezeve UV
- rezistent ndaj ujit
- nuk ka tkurrje
- fleksibilitet i jashtëzakonshëm
- lidhje kristale transparente

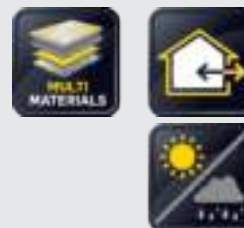

TRANSPARENT

\*Nuk është i përshtatshëm për ngjitjen e materialeve të tilla si PE, PP, PTFE, qelqit akrilik, bakrit, tunxhit dhe PVC-së së butë.

Kodi	Pesha	Ngjyra	Cmimi
1963630	290 gr	Transparent	990





## WOOD STANDARD

### Ngjitës për dru



#### Aplikimi:

- për të gjitha llojet e drurit dhe materialeve të ngjashme me dru
- lëkurë
- tekstil
- karton
- tape
- polistiren

STANDARD

#### KARAKTERISTIKAT

- i gatshëm për përdorim
- lidhja është transparente, mund të lëmohet, lyhet dhe llakohet
- aplikim praktik dhe preciz, falë majës së hollë dhe bombolës së butë
- për hapësira të brendshme dhe të jashtme



Kodi	Pesha	Ngjyra	Cmimi
1438647	250 gr	Transparent	450
1438656	750 gr	Transparent	750

## WOOD EXPRESS

### Ngjitës për dru



#### Aplikimi:

- për të gjitha llojet e drurit dhe materialet e ngjashme me dru
- dyer
- dritare
- tavolina kuzhine

EXPRESS

#### KARAKTERISTIKAT

- i gatshëm për përdorim
- lidhja është transparente
- në temperaturën e dhomës arrin forcë të lartë vetëm pas 5 minutash
- për hapësira të brendshme dhe të jashtme

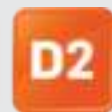

Kodi	Pesha	Ngjyra	Cmimi
1438361	250 gr	Transparent	490
1438318	750 gr	Transparent	790

## WOOD WATERPROOF

### Ngjitës rezistent ndaj ujit për dru



#### Aplikimi:

- për të gjitha llojet e drurit dhe materialet e ngjashme me dru
- dyer
- dritare
- tavolina kuzhine

REZISTENT NDAJ UJIT

#### KARAKTERISTIKAT

- i gatshëm për përdorim
- rezistent ndaj lagështisë
- lidhja është transparente
- për materiale të ekspozuara ndaj lagështirës së lartë të ajrit ose ekspozimit afatshkurtër ndaj ujit
- për hapësira të brendshme dhe të jashtme



Kodi	Pesha	Ngjyra	Cmimi
1438873	250 gr	Transparent	590
1438876	750 gr	Transparent	950
1438857	5 kg	Transparent	4.900

## UNIVERSAL

### Ngjitës univesal kontaktues

#### Aplikimi:

- dru
- plastikë\*
- material sintetik
- gomë
- tape
- lëkurë
- felt
- PVC e fortë
- metal

\*Përveç për PE, PP, PTFE

UNIVERSAL

#### KARAKTERISTIKAT

- për sipërfaqe absorbuese dhe jo absorbuese
- Lidhjet janë të qëndrueshme, të papërshkueshme nga uji, elastike, rezistente ndaj temperaturave të larta (deri në 110°C)
- përballon ngarkesat menjëherë
- pa toluol
- për zdrukhtari dhe punime dekorative (tapiceri)



Kodi	Pesha	Ngjyra	Cmimi
1429587	50 ml	Transparent	250
1429588	120 ml	Transparent	390
1430133	800 ml	Transparent	1.590

## Shoe Glue

### Ngjitës për këpucë



Aplikimi:

- dru
- metal
- gomë
- lëkurë
- tekstil

TRANSPARENT

KARAKTERISTIKAT

- me bazë poliuretani
- i tejdukshëm
- krijon një bashkim të padukshëm gjatë ngjitjes
- rezistent ndaj ujit
- rezistent ndaj temperaturave deri në +60°C



Kodi	Pesha	Cmimi
2925852	50 ml	250

## Power Tape

### Shirit ngjitës universal, me tre shtresa, i përforcuar me fibra



Aplikimi:

- dru
- metal
- plastikë
- gomë
- karton
- qelq

PËR 1001 APLIKIME

KARAKTERISTIKAT

- për përdorim të brendshëm dhe të jashtëm
- bashkon, mbërthen, vulos, lidh, ngjit, fikson, përforcon
- i pazëvendësueshëm në shtëpi, kopsht, automjet apo në udhëtim
- i disponueshëm në ngjyrë argjendi - gri (10m dhe 25m)

Kodi	Dimensioni	Cmimi
2958188	10 mm	590
2960386	25 mm	850

## Repair Epoxy

### Ngjitës epoksid i lëngshëm 2K



KARAKTERISTIKAT

- për të gjitha materialet (veçanërisht për metal)
- shiringë e dyfishitë plastike = e lehtë për përdorim
- mundëson forcë dhe qëndrueshmëri
- ngjit shpejt - koha e përzierjes dhe e aplikimit është 5 minuta
- koha për korrigjim (koha e hapur) - 15 minuta pas aplikimit
- koha e tharjes është 2 orë - mbetet transparente

I LENGHEM

- Pas 2 orësh arrin forcën mbajtëse prej 120 kg/cm<sup>2</sup>
- rezistent ndaj temperaturave nga -30°C deri në +150°C
- rezistent ndaj ujit dhe vajit

Kodi	Pesha	Cmimi
2751320	6 ml	250

## Pattex Hot

### Pistoletë dhe ngjitës për ngjitje të nxehtë

KARAKTERISTIKAT

- ideal për ngjitjen e dekoreve
- për një gamë të gjerë nënshtresash, të tilla si tulla, qeramika, betoni, kartoni, lesoniti dhe pllaka gipsi, guri, pllaka MDF, UPVC.
- pistoletë termike me patrona për ngjitje të nxehtë
- për riparime të shpejta, montime dhe punime dekorative
- ngjit jashtëzakonisht shpejt, për më pak se 2 minuta
- ngjitës i tejdukshëm, i pangjyrë dhe elastik me forcë të lartë ngjitëse

PISTOLETË DHE PATRONA



Kodi	Pesha	Cmimi
2112980	290 gr	2.500

## Shirit Pattex FIX – shirit ngjites i dyanshem



Shirit i forte montimi me dy ane per montim te thjeshte, te shpejte dhe afatgjate. E perkryer per fiksimin dhe vendosjen e grepave, shenjave, numrave, fotove, aksesoreve ne banje, makine etj. Mundesi perdorimi brenda dhe jashte. Ju nuk keni nevojte te jeni profesioniste, nuk keni nevojte per mjete apo paisje speciale. Ju mund ti thoni lamtumire shpimit dhe bluarjes. Nuk duhet te shqetesoheni nese fuga do ta mbaje sepse kushdo mund te perdore shiritin e dyanshem Pattex FIX dhe te perfundoje ne cdo material.

### KARAKTERISTIKAT

- Ngjitje e menjehershme
- Per brenda dhe jashte
- rezistent daj ujit

Kodi	Gjatesia	Cmimi
1486524	1.5 mr	650



# ZGJIDH PARTNERIN E KONFIRMUAR



JASHTEZAKONISHT I **F**ORTE

THARJE E >>> SHPEJTE

MUND TE PARA **NGJYROSET**





## SUPER BOND LIQUID

Super ngjitës i lëngshëm

Aplikimi:  
gomë, lëkurë, plastikë\*,  
porcelan, dru,  
metal, karton, letër

KARAKTERISTIKAT

- SUPER I SHPEJTË
- SUPER I FORTË

\*nuk ngjit PE/PP

Kodi	Pesha	Cmimi
1409563	3 gr	120



## SUPER BOND POWER GEL

Super ngjitës fleksibël

Aplikimi:  
gomë, lëkurë, plastikë\*,  
porcelan, dru, metal,  
karton, letër

KARAKTERISTIKAT

- SHUMË I FORTË
- FLEKSIBËL
- përmban grimca gome
- dozim i saktë - pa pika!
- rezistent ndaj goditjeve dhe vibrimeve

\*ne lepi PE/PP

Kodi	Pesha	Cmimi
1409568	2 gr	120



## SUPER BOND POWER EASY

Ngjitës super

Aplikimi:  
gomë, lëkurë, plastikë\*,  
porcelan, dru, metal,  
karton, letër

KARAKTERISTIKAT

- NUK NGJIT GISHTAT!
- pa tretës
- pa erë të pakëndshme

\*nuk ngjit PE/PP

Kodi	Pesha	Cmimi
1536388	2 gr	150



## SUPER BOND Creative Pen

Ngjitës super

Për aplikim të saktë dhe të pastër.

Ngjitësi i ri në formën e lapsit  
ju mundëson të aplikoni ngjitësin  
pikë-pikë, pa rrëmuje.

Aq thjeshtë sa përdorimi i stilolapsit!

KARAKTERISTIKAT

- JASHTËZAKONISHT I FORTË!
- aplikimi pikë-pikë
- saktësi e jashtëzakonshme



Ngjit për disa sekonda



Dozim i kontrolluar



Kapak kundër bllokimit



Paketim i bërë nga 80% materiale të ricikluara

Kodi	Pesha	Cmimi
2734576	3 gr	450



## LOCTITE MINI TRIO

**Aplikimi:**  
gomë, lëkurë, plastikë\*,  
porcelan, dru, metal,  
karton, letër  
\*nuk ngjit PE/PP

### KARAKTERISTIKAT

- JASHTËZAKONISHT I FORTË
- REZISTENT NDAJ UJIT
- Gjithmonë e freskët!
- Vjen në tre tuba të veçantë



Ngjit për disa sekonda



Rezistent ndaj goditjeve dhe ujit



Gjithmonë i freskët

Kodi	Pesha	Cmimi
2733331	3x1 gr	180



## LOCTITE BRUSH

**Aplikimi:**  
gomë, lëkurë, plastikë\*,  
porcelan, dru, metal,  
karton, letër  
\*nuk ngjit PE/PP

### KARAKTERISTIKAT

- Ngjit për disa sekonda
- Rezistent ndaj goditjeve dhe ujit
- Aplikues në formë furçe
- Shishe që parandalon rrjedhjen
- 80% ambalazh e ricikluar



Ngjit për disa sekonda



Rezistent ndaj goditjeve dhe ujit



Aplikues në formë furçe



Shishe që parandalon rrjedhjen



Paketim i bërë nga 80% materiale të ricikluara

Kodi	Pesha	Cmimi
3733278	5 gr	250



## LOCTITE PRECISION

**Aplikimi:**  
gomë, metal, dru,  
lëkurë, karton, letër,  
plastikë\*

\*nuk ngjit PE/PP

### KARAKTERISTIKAT

- JASHTËZAKONISHT I SHPEJTË
- REZISTENT NDAJ UJIT DHE GODITJEVE
- Saktësi e jashtëzakonshme e mundësuar nga maja e zgjatur e tubit
- Për vende të vështira për t'u arritur



Ngjit për disa sekonda



Rezistent ndaj goditjeve dhe ujit



Qafë e gjatë dhe precize



Kapak kundër bllokimit



Paketim i bërë nga 80% materiale të ricikluara

Kodi	Pesha	Cmimi
3733272	5 gr	250



# Thuaj PO riparimit.

# JINI TE SIGURT ME TANGIT



PËRZGJEDHJE E PRODHUESVE TË TUBAVE DHE PROFESIONISTËVE PËR MË SHUMË SE 50 VITE



## Tangit ngjitës PVC-U

Ngjitës Tangit për PVC të fortë dhe tuba me presion të lartë me mbrojtje maksimale nga rrjedhjet.

- Koha e hapur e punimit 4 minuta
- Mundësia e tejkalimit të boshllëqeve më të gjera
- Bashkimet e ngjitura janë po aq rezistente sa materiali i tubave të ngjitur
- Në përputhje me standardet EN 14814, EN 14680, EN 1329
- Përdorim i thjeshtë dhe i pastër

Kodi	Permasa	Ngjyra	Cmimi
182753	125 gr	Neutral	1.990
417454	1 Kg	Neutral	3.990



## Tangit Uni-Lock

Fije Tangit Uni-Lock për vulosjen e tubave plastikë dhe metalikë. Zgjidhja më e shpejtë, më e pastër dhe më e efikase për vulosjen e fijeve.

- I përshtatshëm për përdorim në tuba metalikë dhe plastikë
- Aplikim i pastër, i shpejtë dhe i thjeshtë
- Përdoret pa mjete dhe materiale shtesë
- Përdoret për tubacionet e ujit të pijshëm deri në +130°C (7 bar)
- I përshtatshëm për vulosjen e sistemeve të ngrohjes dhe gazit nga 20°C deri në +70°C (5 bar)

Kodi	Permasa	Ngjyra	Cmimi
2055957	160 mm	Neutral	1.990
2732451	20 mm	Neutral	650



## AERO 360° - Thithës lagështie Gjeneratë e re e thithësve të lagështisë



### KARAKTERISTIKAT

- thith lagështinë
- neutralizon erërat e pakëndshme
- veçanërisht për dhoma të vogla (deri në 20 m<sup>2</sup>)
- pikat e para shfaqen pas 24 orësh\*
- rekomanduar nga AFPRAL (shoqata franceze për parandalimin e alergjive)

\*në varësi të lagështisë së ajrit dhe temperaturës në dhomë

Kodi	Pesha	Ngjyra	Cmimi
2628096	450 gr	Blu	1.490

## AERO 360° - Thithës lagështie Gjeneratë e re e thithësve të lagështisë



### KARAKTERISTIKAT

- thith lagështinë
- neutralizon erërat e pakëndshme
- veçanërisht për dhoma të vogla (deri në 20 m<sup>2</sup>)
- pikat e para shfaqen pas 24 orësh\*
- rekomanduar nga AFPRAL (shoqata franceze për parandalimin e alergjive)

\*në varësi të lagështisë së ajrit dhe temperaturës në dhomë

Kodi	Pesha	Ngjyra	Cmimi
2628127	450 gr	Bardhe	1.490



## AERO 360° - Power Tab TABLETA Mbushje për pajisjet AERO 360°

### KARAKTERISTIKAT

- transformon lagështinë në një tretësirë të kripur
- neutralizon erërat e pakëndshme
- zvogëlohet gradualisht në vëllim për shkak të rithijes së lagështirës

Kodi	Pesha	Aroma	Cmimi
2629139	280 ml	Livando	1.290
2259563	280 ml	Neutrale	1.290

ABSORBUES  
LAGESHTIE  
**PARTNERI JUAJ**  
**ME I MIRE**  
NE LUFTEN KUNDER  
LAGESHTISE



**Mallo llaci me doreze druri**



Kodi.	Te dhena	Çmimi
0111	270x180mm	490
0112	350x270mm	690
0113	420x260mm	790

**Mallo patinimi Inoxi**

Doreze gome 2 komponente, Çelik inox, rezistent ndaj acidit, trashësi 0.7 mm



Kodi.	Te dhena	Çmimi
0206	130x270mm	790

**Mallo patinimi Inoxi me dhembe**

Çelik inox, rezistent ndaj acidit, trashësi 0.7 mm



Kodi.	Te dhena	Çmimi
0242	130x270 / 6x6	750
0245	130x270 / 12x12	750

**Mallo patinimi Inoxi**

Me doreze gome 3 komponente



Kodi.	Te dhena	Çmimi
0250	130x480mm	1.290

**Mallo patinimi Inoxi**

Me doreze gome 3 komponente



Kodi.	Te dhena	Çmimi
0254	130x480 / 10x10	1.200

**Mallo plastike**

E doreze te hapur



Kodi.	Te dhena	Çmimi
0301	130x270mm	350

**Mallo plastike**

Me doreze te mbyllur



Kodi.	Te dhena	Çmimi
0305	130x270mm	290

**Mallo patinimi plastike**

Me sfungjer te bute



Kodi.	Te dhena	Çmimi
0311	140x280mm	490

### Mallo patinimi plastike

Me sfungjer te ashper



Kodi.	Te dhena	Çmimi
0312	140x280mm	490

### Mallo patinimi plastike

Me gome



Kodi.	Te dhena	Çmimi
0320	140x280mm	590

### Mallo plastike

Me sfungjer hidrofilik



Kodi.	Te dhena	Çmimi
0324	140x280mm	590

### Mallo gerryese me dhembeza

Me doreze plastike



Kodi.	Te dhena	Çmimi
0335	130x270mm	650

### Mallo gerryese me dhembeza

Me dhembeza dhe doreze plastike



Kodi.	Te dhena	Çmimi
0341	165x365mm	690

### Mallo plastike

E doreze te hapur Euro



Kodi.	Te dhena	Çmimi
0355	130x270mm	390

### Mallo plastike

Me doreze me 2 komponente



Kodi.	Te dhena	Çmimi
0381	130x270mm	390

### Mallo inoxi

Me doreze plastike



Kodi.	Te dhena	Çmimi
0401	130x270mm	590



### Mallo inoxi me dhembe

Me doreze plastike



Kodi.	Te dhena	Çmimi
0402	130x270mm / 4x4	690
0403	130x270mm / 6x6	690
0404	130x270mm / 8x8	690
0405	130x270mm / 10x10	690
0406	130x270mm / 12x12	690

### Mallo inoxi

Me doreze druri



Kodi.	Te dhena	Çmimi
0472	130x270mm	1.100

### Shpatull inoxi

Me doreze druri



Kodi.	Te dhena	Çmimi
0563	350mm	1.290

### Shpatull inoxi

Me doreze gome  
2 komponente



Kodi.	Te dhena	Çmimi
0571	120mm	550
0572	140mm	550
0573	160mm	590
0574	180mm	590

### Shpatull multifunkionale



Kodi.	Te dhena	Çmimi
0584	60mm	350

### Shpatull inoxi

Me doreze plastike  
2 komponente



Kodi.	Te dhena	Çmimi
0585	40mm	330
0586	60mm	350
0587	80mm	390
0588	100mm	450

### Shpatull inoxi

Me doreze druri



Kodi.	Te dhena	Çmimi
0590	100mm	490
0591	120mm	550
0592	140mm	590
0593	160mm	650

### Shpatull plastike dore



Kodi.	Te dhena	Çmimi
0701	140x280x235 pa dhembe	220
0702	4x6 / 235mm me dhembe	220
0703	6x6 / 235mm me dhembe	220

### Mistri inoxi e rrumbullaket

Me bisht druri



Kodi.	Te dhena	Çmimi
0820	180x106x60mm	590
0821	200x112x60mm	690
0822	220x120x60mm	790

### Mistri katrore

Me bisht druri



Kodi.	Te dhena	Çmimi
0808	115x160x90mm	690
0809	120x180x80mm	750

### Mistri inoxi

Per stuko



Kodi.	Te dhena	Çmimi
0905	80x140mm	590

### Mistri inoxi

Per stuko



Kodi.	Te dhena	Çmimi
0906	55x160mm	550

### Mistri inoxi

Per stuko



Kodi.	Te dhena	Çmimi
0907	20x160mm	550

### Mistri inoxi kendesh

E jashtme



Kodi.	Te dhena	Çmimi
0908	6085mm	690

### Mistri inoxi kendesh

E brendshme



Kodi.	Te dhena	Çmimi
0909	6085mm	690

### Mistri inoxi

E brendshme me 3 faqe



Kodi.	Te dhena	Çmimi
0911	80x83mm	690

**Mistri katrore**

Me bisht druri



Kodi.	Te dhena	Çmimi
1001	145mm	390

**Mistri e shkurter katrore**

Me bisht druri



Kodi.	Te dhena	Çmimi
1002	80mm	390
1003	100mm	450

**Mistri inoxi e holle**

Me doreze me 2 komponente



Kodi.	Te dhena	Çmimi
1111	8mm	490
1112	10mm	490
1113	12mm	490

**Mistri e holle**

Me bisht druri



Kodi.	Te dhena	Çmimi
1121	8mm	550
1122	10mm	550
1123	12mm	550

**Koke plastike**

E rrumbullaket



Kodi.	Te dhena	Çmimi
1501	12L	390
1502	16L	450
1503	20L	490

**Kove Ilaci**

E rrumbullaket



Kodi.	Te dhena	Çmimi
1504	65L	1.290
1505	90L	1.590

**Set me 4 shpatulla**

Inoxi



Kodi.	Te dhena	Çmimi
1624	50,75,100,125mm	250

**Set me 4 shpatulla inoxi**

Me doreze plastike



Kodi.	Te dhena	Çmimi
1625	50,75,100,125mm	490



## Sungjer per bojak

pa vrime / me vrime per bojak



Kodi.	Te dhena	Çmimi
1680	110x160mm	200
1684	110x160mm me vrime	220

## Mallo inoxi

Me doreze druri



Kodi.	Te dhena	Çmimi
2601	130x270mm	550

## Mallo inoxi

Me dhembe dhe doreze druri



Kodi.	Te dhena	Çmimi
2602	130x270mm / 4x4	550
2603	130x270mm / 6x6	550
2604	130x270mm / 8x8	550
2605	130x270mm / 10x10	550
2606	130x270mm / 12x12	550

## Mallo inoxi

Me doreze druri / Me doreze druri dhe dhembe



Kodi.	Te dhena	Çmimi
2621	130x480mm	1.100
2622	130x480mm / 10x10	1.150

## Mallo plastike

Me sfungjer te bute / hidrofolik



Kodi.	Te dhena	Çmimi
2641	140x280mm / te bute	550
2642	140x280mm / hidrofilik	550
2649	140x280mm / hidrofilik	550

## Shpatull inoxi

Doreze plastike e gjere



Kodi.	Te dhena	Çmimi
2651	200mm	330
2652	300mm	390
2653	450mm	550

## Shpatull inoxi

Doreze plastike



Kodi.	Te dhena	Çmimi
2661	40mm	110
2662	200mm	140
2663	80mm	150
2664	100mm	160

## Shpatull inoxi

Me doreze plastike



Kodi.	Te dhena	Çmimi
2672	120mm	390
2673	140mm	390
2674	160mm	400
2675	180mm	450
2676	200mm	490
2677	220mm	490

Filamenti **FillPro**® është një filament i prodhuar tërësisht nga ne njësi inxhinierike me qendër në Pordenone. Është prodhuar tërësisht në Itali me material të ricikluar dhe pa përdorimin e tretësve.

- Thithje më e madhe e bojës
- Çlirim gradual i bojës dhe përfundim perfekt
- Nuk ka humbje të elasticitetit të fibrave në kontakt me ujin



Konike

**QUALITÀ**  **MADE IN ITALY**

**NUK I BIEN QIMET  
ZGJAT ME SHUME**

- Furça monoblok pa kapje me gozhde
- Garanton rezistencë më të mirë

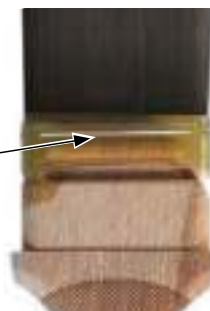

**LaserTouch**®

**LaserTouch**® është një gdhendje e veçantë lazer papërdorimi i tretësve, i cili përmirëson kapjen dhe komoditetin e përdorimit. Dorezë druri e certifikuar nga FSC.



**AirTouch**®

**AirTouch**® është futja e një jastëku ajri në “zonën e kapjes” së veglës. Ndhmon në shmangien e formimit të fluskave dhe dhimbjeve të gishtave.



**INOVACION - RRULA DHE MINI RULLA TEFLON**®

Mbrojtësi i sipërfaqes TEFLON® është një trajtim i veçantë jo ngjitëse e cila, kur aplikohet në pëlhurë, përmirëson performancën e rullit

- punë më pak e lodhshme dhe kursim i konsiderueshëm i kohës
- absorbim më i madh dhe çlirim total i bojës
- lehtë për t'u pastruar me shumë pak ujë.

## Furce trekendore Universale me bisht gome

Futja e një jastëku ajri në “zonën e kapjes”. Ndhmon në shmangien e formimit të fluskave dhe dhimbjeve të gishtave. Përdorim i lehtë.

### **AirTouch**®

Kodi	Permasa	Çmimi
199041	21 mm	490



## Furce e sheshte Universale me bisht gome

Futja e një jastëku ajri në “zonën e kapjes”. Ndhmon në shmangien e formimit të fluskave dhe dhimbjeve të gishtave. Përdorim i lehtë.

### **AirTouch**®

Kodi	Permasa	Çmimi
194968	25 mm	490
194969	38 mm	550
194970	50 mm	690
194971	65 mm	750



## Furce e rumbullaket me bisht druri

Kodi	Permasa	Çmimi
1007/3	15 mm	250



## Furce e sheshte Universale me bisht druri

Dorëze me gëdhendje pa përdorimin e tretësve. Praktike dhe komode në punë për boje uji.

### **LaserTouch**®

Kodi	Permasa	Çmimi
496100257	25 mm	330
496100387	38 mm	350
496100507	50 mm	390
496100657	65 mm	590



## Furce Precizioni per Boje Akrilik ErgoTouch me bisht gome

Furce inovative me vetitë e qimeve natyrale. Punë komferte. Nuk le gërvishtje në sipërfaqe. Mbulim me cilësi të lartë.

### **ErgoTouch**®

Kodi	Permasa	Çmimi
18301 30	30 mm	390
18301 50	50 mm	550





Furce e sheshte per Boje Akrilik Pro

## ProFlat®

Kodi	Permasa	Çmimi
345120	20 mm	290
345130	30 mm	330
345140	40 mm	390
345150	50 mm	490
345160	60 mm	650
345170	70 mm	790



Furce trekendore AIRTOUCH per metale

Futja e një jastëku ajri në “zonën e kapjes”. Ndhmon në shmangien e formimit të fluskave dhe dhimbjeve të gishtave.

## AirTouch®

Kodi	Permasa	Çmimi
199038	21 mm	490



Furce e sheshte AIRTOUCH per metale

Futja e një jastëku ajri në “zonën e kapjes”. Ndhmon në shmangien e formimit të fluskave dhe dhimbjeve të gishtave.

## AirTouch®

Kodi	Permasa	Çmimi
194964	25 mm	490
194967	65 mm	750



Furce per Boje me Baze Tretes me bisht druri

Dorëze me gëdhendje papërdorimin e tretësve. Praktike dhe komode në punë.

## LaserTouch®

Kodi	Permasa	Çmimi
496180257	25 mm	290
496180387	38 mm	350
496180507	50 mm	390



Furce e sheshte per Llak Pro

Me qime FillPro, profesionale për llak. Dorezë polipropileni. Kapese bronzi.

## ProFlat®

Kodi	Permasa	Çmimi
117330	30 mm	290
117350	50 mm	490
117360	60 mm	650



## Furce e sheshte me bisht plastik

Qime te gjata dhe te buta  
Te pershtatshme per cdo lloj boje.

Kodi	Permasa	Çmimi
4342030	30 mm	120
4342050	40 mm	150
4342060	50 mm	190



## Furce trekendore per Lyrje Druri

Futja e një jastëku ajri në “zonën e kapjes”. Ndhmon në shmangien e formimit të fluskave dhe dhimbjeve të gishtave.

### *AirTouch*®

Kodi	Permasa	Çmimi
199044	21 mm	490



## Furce e sheshte per Lyrje Druri

Futja e një jastëku ajri në “zonën e kapjes”. Ndhmon në shmangien e formimit të fluskave dhe dhimbjeve të gishtave.

### *AirTouch*®

Kodi	Permasa	Çmimi
194972	38 mm	550
194974	50 mm	690



## Furce e sheshte Pro per Lyrje Druri

Me qime FillPro, profesionale për llak.  
Dorezë polipropileni. Kapese bronzi.

### *ProFlat*®

Kodi	Permasa	Çmimi
345230	30 mm	350
345250	50 mm	550
345260	60 mm	650



## Furce per Llak SPALTER

Me bisht plastik ergonomik.

Kodi	Permasa	Çmimi
181-100	100 mm	490
181-120	120 mm	650
181-150	150 mm	790





**NESPOLI  
GROUP**

## Rrul me bisht gome, qime 12mm Poliamid



Trajtim i veçantë jo ngjitës i cili, kur aplikohet në pëlhurë, përmirëson performancën e rullit. Punë më pak e lodhshme dhe kursim i konsiderueshëm i kohës. Absorbim më i madh dhe çlirim total i bojës. Lehtë për t'u pastruar me shumë pak ujë.



Kodi	Permasa	Çmimi
R95677525R	250mm x Ø 55mm	1.290

## Rrul me bisht gome, qime 17mm, 55mm per ambiente te brendshme dhe fasada

### **GrandPro**®

Kodi	Permasa	Çmimi
NPR7482555	250mm x Ø 55mm	1.200



## Rrul mini gome me bisht gome 10cm, qime 12mm



Trajtim i veçantë jo ngjitës i cili, kur aplikohet në pëlhurë, përmirëson performancën e rullit. Punë më pak e lodhshme dhe kursim i konsiderueshëm i kohës. Absorbim më i madh dhe çlirim total i bojës. Lehtë për t'u pastruar me shumë pak ujë.

Kodi	Permasa	Çmimi
560112835	10 cm	490



## Set me 2 rrula rezerve mini, qime 12mm



Trajtim i veçantë jo ngjitës i cili, kur aplikohet në pëlhurë, përmirëson performancën e rullit. Punë më pak e lodhshme dhe kursim i konsiderueshëm i kohës. Absorbim më i madh dhe çlirim total i bojës. Lehtë për t'u pastruar me shumë pak ujë.

Kodi	Permasa	Çmimi
524760211	2 x 10 cm	350



## Rrul mini gome mikrofiber me bisht, qime 6mm



Trajtim i veçantë jo ngjitës i cili, kur aplikohet në pëlhurë, përmirëson performancën e rullit. Punë më pak e lodhshme dhe kursim i konsiderueshëm i kohës. Absorbim më i madh dhe çlirim total i bojës. Lehtë për t'u pastruar me shumë pak ujë.

Kodi	Permasa	Çmimi
560118693	10 cm	550





## Set me 2 Mini Rrula Mikrofiber, qime 6mm



Trajtim i veçantë jo ngjitës i cili, kur aplikohet në pëlhurë, përmirëson performancën e rulit. Punë më pak e lodhshme dhe kursim i konsiderueshëm i kohës. Absorbim më i madh dhe çlirim total i bojës. Lehtë për t'u pastruar me shumë pak ujë.

Kodi	Permasa	Çmimi
56122869	2 x 10 cm	450



## Rrul rezerve 180mm, per dru

### *MicroPro*®

Kodi	Permasa	Çmimi
NPR7471855R	180mm 9 mm x Ø 55 mm	550
NPR7472555R	250mm 9 mm x Ø 55 mm	590



## Rrul rezerve poliamide



Trajtim i veçantë jo ngjitës i cili, kur aplikohet në pëlhurë, përmirëson performancën e rulit. Punë më pak e lodhshme dhe kursim i konsiderueshëm i kohës. Absorbim më i madh dhe çlirim total i bojës. Lehtë për t'u pastruar me shumë pak ujë.

Kodi	Permasa	Çmimi
R95677518RPOL	180mm 12 mm x Ø 55 mm	750
R95677525RPOL	250mm 12 mm x Ø 55 mm	950



## Rrul rezerve akrilik, poliester



Trajtim i veçantë jo ngjitës i cili, kur aplikohet në pëlhurë, përmirëson performancën e rulit. Punë më pak e lodhshme dhe kursim i konsiderueshëm i kohës. Absorbim më i madh dhe çlirim total i bojës. Lehtë për t'u pastruar me shumë pak ujë.

Kodi	Permasa	Çmimi
NPR7121855R	180mm 14 mm x Ø 55 mm	590
NPR7122555R	250mm 14 mm x Ø 55 mm	790

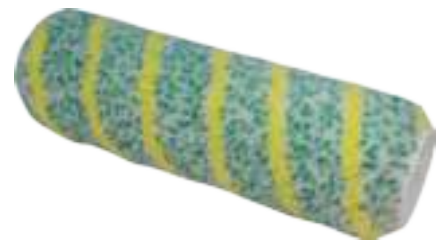

## Rrul rezerve per ambiente te brendshme dhe fasada

### *GrandPro*®

Kodi	Permasa	Çmimi
NPR7481855R	180mm 17 mm x Ø 55 mm	590
NPR7482555R	250mm 17 mm x Ø 55 mm	690



### Rrul rezerve, i bardhe, qime 9mm

Trajtim i veçantë jo ngjitës. Absorbim më i madh dhe çlirim total i bojës. Lehtë për t'u pastruar me shumë pak ujë.



Kodi	Permasa	Çmimi
528370218	180mm x Ø 48 mm	250
528370225	250mm x Ø 48 mm	330

### Rrul rezerve poliakrilik, qime 12mm

Absorbim më i madh dhe çlirim total i bojës. Lehtë për t'u pastruar me shumë pak ujë. Me qime 12mm



Kodi	Permasa	Çmimi
527370218	180mm x Ø 48 mm	250
527370225	250mm x Ø 48 mm	330

### Rrul rezerve, qime 18mm

Absorbim më i madh dhe çlirim total i bojës. Lehtë për t'u pastruar me shumë pak ujë. Me qime te gjata 18mm.



Kodi	Permasa	Çmimi
529370218	180mm x Ø 55 mm	250
529370225	250mm x Ø 55 mm	330

### Rrul rezerve poliakrikik, qime 18mm

Për ambientet e jashtme. Absorbim më i madh dhe çlirim total i bojës. Lehtë për t'u pastruar me shumë pak ujë.



Kodi	Permasa	Çmimi
527330218	180mm	330
527330225	250mm	350

### Bisht rruli rezerve me doreze gome



Kodi	Permasa	Çmimi
199180	18 cm x Ø 8 mm	350
199250	25 cm x Ø 8 mm	390



### SHKUMË PËR MBUSHJE DHE IZOLIME

Shkumë poliuretani e dizenuar për instalim të shpejtë dhe të lehtë të dritareve dhe dyerve, për mbushjen e plasaritjeve dhe për izolim. Përdoret me lagështi ajri.

Aplikimi i saktë i shkumës lejon punë më të shpejtë dhe konsum ekonomik. Shkuma e ngurtësuar siguron një lidhje të fortë dhe veti të shkëlqyera izoluese. Sigurohuni që shkuma të mbrohet nga rrezatimi UV pas përfundimit të punës.

**Kodi: 752213**

**Koha e tharjes:**

1.5-5 orë

**Koha e ngjitjes:**

5-10 min

Pas aplikimit zgjerohet 2-3 herë në vëllim.

Çmimi

**450**



### SHKUMË ME PISTOLETË PËR DYER DHE DRITARE

Shkumë poliuretani me një komponent me zgjerim të ulët për instalimin e dritareve dhe dyerve dhe mbushjen e hapjeve. Për montim të shpejtë të kornizave të dritareve dhe dyerve për ngjitjen dhe fiksimin e materialeve të ndryshme të ndërtimit si: shkallët prej druri, pragjet e dritareve etj.

**Kodi: 752215**

**Koha e tharjes:**

1.5-5 orë

**Koha e ngjitjes:**

5-10 min

Me zgjerim të ulët pas aplikimit.

Çmimi

**790**



### SILIKON SANITAR ANTIMYK

Për mbylljen e fugave më ngarkesë të vogël tek te cilat ekziston mundësia e paraqitjes së mykut, për mbylljen e materialeve silikate, për instalimin e xhamave në korniza alumini, për instalimin e xhamit dhe të xhamit të profilizuar.

**Kodi: 752218 - I BARDHE**

**Kodi: 752219 - TRANSPARENT**

**Koha e ngjitjes:**

20 min. (23°C/50% lagështia rel.)

**Temp aplikimit:**

290 L prej +5°C deri +40°C

Çmimi

**490**



### SHKUMË PËR MBUSHJE DHE IZOLIME ME PISTOLETË

Ngjitës poliuretani me një përbërës, është projektuar posaçërisht për ngjitjen e paneleve termoizoluese (polistireni, lesh guri, poliuretani) në sipërfaqet e ndërtesave, për instalimin e dritareve dhe dyerve dhe mbushjen e hapjeve

Aplikimi i saktë dhe forcimi i shpejtë i ngjitësit mundësojnë kryerjen më të shpejtë të punimeve përfundimtare dhe konsum më të ulët, se sa me ngjitësit e çimentos.

**Kodi: 752214**

**Koha e tharjes:**

1.5-2 orë

**Koha e ngjitjes:**

6-12 min

Pas aplikimit zgjerohet 2-3 herë në vëllim.

Çmimi

**590**



### SILIKON UNIVERSAL TRANSPARENT

Për mbylljen e fugave, ngjitje të shkëlqyer në shumicën e materialeve silikate (alumin, qeramikë, qelq, sipërfaqe të glazuara, xham të profilizuar, klinker, porcelan...) Rezistente ndaj spektrit të gjerë të kimikateve, rrezeve UV dhe kohës.

**Kodi: 752216 - I BARDHE**

**Kodi: 752217 - TRANSPARENT**

**Koha e ngjitjes:**

20 min. (23°C/50% lagështia rel.)

**Temp aplikimit:**

prej +5°C deri +40°C

Çmimi

**290**



### MBUSHËS UNIVERSAL AKRILIK I BARDHË

Për mbylljen e materialeve poroze ndërtimore (mundet edhe të lagështa), të cilat iu nënshtrohen ndikimeve të vogla (kornizat mes dritareve, dyerve). Është rezistente ndaj ndikimeve atmosferike, rrezeve të diellit dhe kohës. Nuk përmban tretës

**Kodi: 752220 - I BARDHE**

**Koha e ngjitjes:**

15 min. (23°C/50% lagështia rel.)

**Temp aplikimit:**

prej +5°C deri +40°C

Çmimi

**190**



**Makineri me Bateri  
dhe Elektrike**



**Aksesore per  
makineri elektrike  
dhe me bateri**



**Makineri ndertimi  
dhe aksesore**

**Makineri  
Saldimi dhe Aksesore**

**Kompresore Ajri  
dhe Aksesore**

**Paisje Servisi  
dhe Aksesore**

**Vegla dore dhe  
aksesore ndertimi**

**Veshje dhe sisteme  
sigurie ne pune**

**Sisteme Fiksimi  
dhe Buloneri**



**Spraj teknik dhe  
ngjites adeziv**

Vidiator  
Trapan  
Matrapik  
Gure Flekisbel  
Luçiduese

Tronkatrçe  
Sharre rrethore  
Zmeriluese  
Freze  
Aspirator



**1-68**  
**1**

Disqe preres  
Disqe pastrimi  
Disqe diamanti  
Leter zmerile  
Cilinder abraziv

Beze zmerile  
Leter Tanku  
Disqe Alumini  
Punto metali  
Freza Betoni

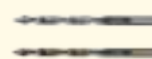

**69-162**  
**2**

Preres asfalti  
Tomak me benzine  
Betoniere  
Disqe asfalti  
Prerese betoni

Helikopter betoni  
Tub Vibrimi  
Vibrator Betoni  
Ngjeshes me benzine  
Disqe betoni



**163-166**  
**3**

Saldatrçe  
Motosaldatrice  
Karikues baterie  
Inverter  
Elektroda

Tel saldimi  
Torçe saldimi  
Pince Saldimi  
Mase saldimi  
Kokore saldimi



**167-198**  
**4**

Kompresore  
Elektromotore  
per kompresore  
Tuba ajri  
Zmeriluese ajri

Rakorderi ajri  
Valvula  
Pistoletë boje  
Pistoletë pastrimi  
Kapse per maja



**199-228**  
**5**

Krik hidraulik  
Krik pneumatik  
Krik krokodil  
Kabell starti  
Nxjerrës magnetik

Leve gomash  
Ekstratore  
Doreza kriketi  
Adaptor kriketi  
Koka kriketi



**229-316**  
**6**

Kuti plastike  
Valixhe  
Furça  
Rrula boje  
Mallo

Prerese pllakash  
Çekiq pllakash  
Vinç  
Metra  
Nivelues



**317-392**  
**7**

Veshje Pune  
Jelek fosforishent  
Doreza  
Rripa sigurimi  
Gambeta

Maska  
Syze  
Kokore mbrojtëse  
Mbulesa  
Kufje



**393-414**  
**8**

Vida  
Upa  
Kendore  
Bulona  
Prizhonier

Rrota  
Fasheta plastike  
Kryqe pllakash  
Pyka pllakash  
Percina



**415-440**  
**9**

Shkume  
Silikon  
Hidroizolues  
Spraj boje  
Spraj teknik

Biadeziv  
Tenie  
Adeziva  
Pasta duarsh  
Aromatizues makine



**441-480**  
**10**

# AH-B

ALUMINIUM HOUSING BODY



PROUDLY  
DESIGNED  
IN JAPAN





**HIKOKI**

# **HIGHTECH**



**IRI**

Pistoleta dadçekesh  
me fuqi të lartë  
shtrenguese  
36 V dhe 18 V

**Zbuloni te rejat me te fundit!**



Sharre me maja vertikale  
me bateri 18 V  
Kapacitet prerje 135 mm

Pistoletë dadçekesh  
Me bateri 36 V  
Force shtrenguese 2400 Nm



Vidiator Gipsi me bateri  
Motor pa karboncina  
Adaptor automatik per vida

**MULTI VOLT**

# Një për të gjithë, të gjithë për një. 1 Bateri, 2 Tensione me mbi 100 vegla

Sistemi ynë inovativ MULTI VOLT i baterisë, përshtatet me një gamë të gjerë veglash pune dhe kopshtarie. Mbi të gjitha kjo bateri është e përshtatshme si për veglat 18 V gjithashtu dhe për veglat 36 V. Gjithashtu është e përshtatshme me të gjitha veglat Hitachi. Tashmë ju keni të mundur të prisni, shponi apo kornni me të njëjtën fuqi si te veglat elektrike por me më tepër liri levizje për të punuar kudo.



18V ↔ 36V

**18 V**



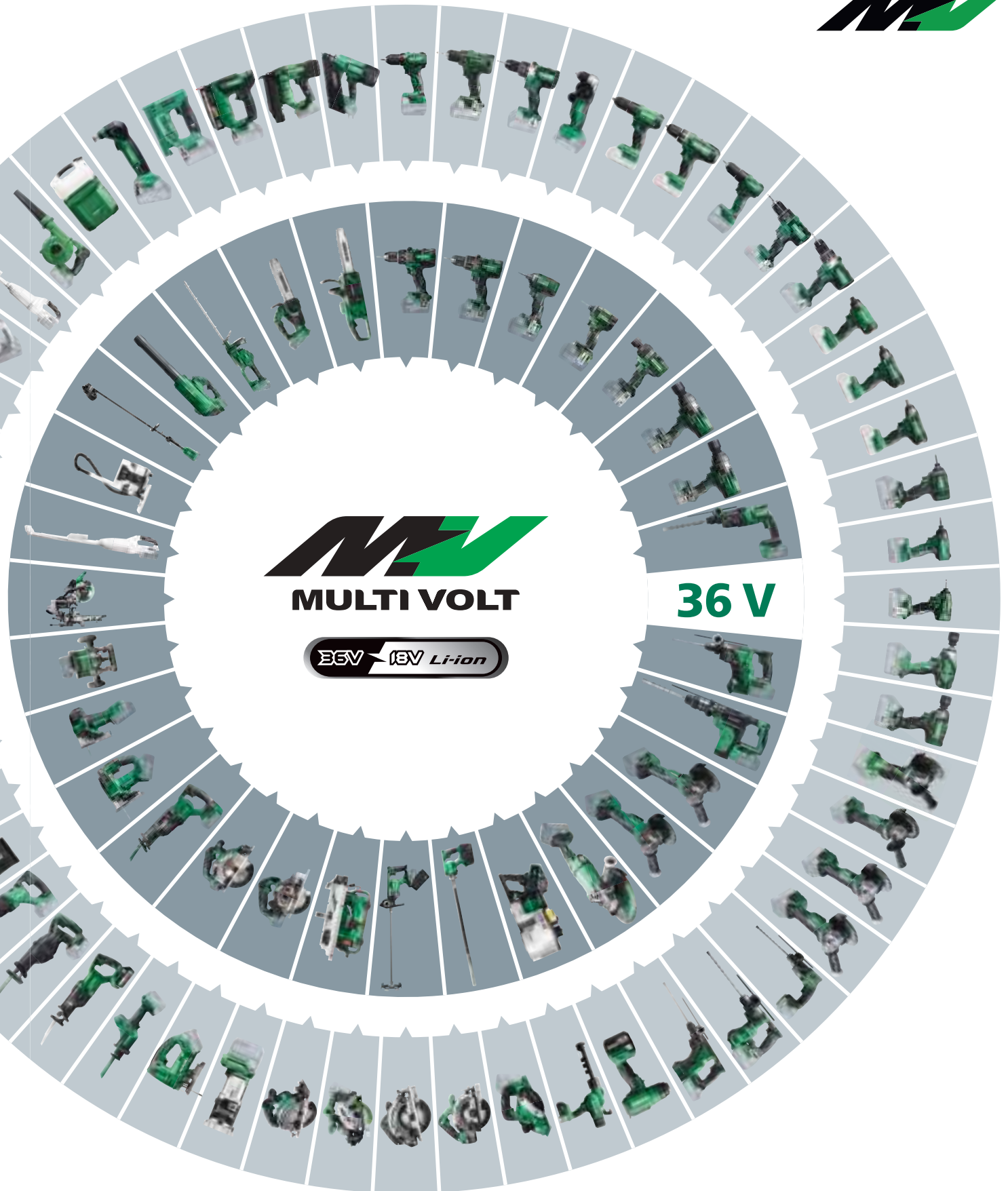

**MULTI VOLT**



**36 V**



## FORCË E JASHTËZAKONSHME SHTRËNGIMI 2400 Nm



Fuqi shtrenguese e larte

4 Shpejtësi me funksionin  
Autostop dhe Autoslow

Mbrojtje e certifikuar IP56

**36V**

Compatible  
**BRUSHLESS**  
**IP56**

### PISTOLETE DADIÇEKESH 3/4" **36V**

**BRUSHLESS**  
**IP56**

44.900

WR36DF-W2Z

Fuqia	36 V
Kapja	3/4"
Kapaciteti bullon	M10-M36
Force shtrenguese max	1.900 Nm
Forca liruese max	2.400Nm
Pesha me bateri	3.9 kg
Motor	Pa karboncina Vetem trup



4 shpejtësi me Autostop  
dhe funksionin Autoslow

### PISTOLETE DADIÇEKESH 1/2" **36V**

**BRUSHLESS**  
**IP56**

42.900

WR36DG-W2Z

Fuqia	36 V
Kapja	1/2"
Kapaciteti bullon	M10-M33
Force shtrenguese max	1.400 Nm
Forca liruese max	2.000Nm
Pesha me bateri	3.9 kg
Motor	Pa karboncina Vetem trup



4 shpejtësi me Autostop  
dhe funksionin Autoslow

### PISTOLETE DADIÇEKESH 1/2" **36V**

**BRUSHLESS**  
**IP56**

69.900

WR36DE-WRZ

Bateri	2 x 36 V / 2.5 Ah
Kapja	1/2"
Kapaciteti bullon	M10-M24
Force shtrenguese max	770 Nm
Forca liruese max	1.050 Nm
Pesha me bateri	2.9 kg
Motor	Pa karboncina



### PISTOLETE DADIÇEKESH 1/2" **36V**

**BRUSHLESS**  
**IP56**

29.900

WR36DE-W2Z

Bateri	36 V
Kapja	1/2"
Kapaciteti bullon	M10-M24
Force shtrenguese max	770 Nm
Forca liruese max	1.050 Nm
Motor	Pa karboncina Vetem trup



### PISTOLETE DADIÇEKESH 3/4" **36V**

**BRUSHLESS**  
**IP56**

39.900

WR36DA-W2

Bateri	36 V
Kapja	3/4"
Kapaciteti bullon	M12-M30
Force shtrenguese max	1.100 Nm
Forca liruese max	1.800 Nm
Motor	Pa karboncina Vetem trup



**VIDIATOR / TRAPAN ME GODITJE 36V**

**BRUSHLESS RFC**

**38.900**

**DV36DC-W2Z**

Fuqia 36 V  
Moment rrotullimi 155 Nm  
Gjatesia 190 mm  
Pesha 2.8 kg  
Shpim Mur/Metal/Dru Ø 22/20/118 mm  
Nr rrotullimeve bosh 0-550 / 2200 rpm  
Motor Pa karboncina Vetem trup



**VIDIATOR ME GODITJE 1/4" 36V**

Compatible **BRUSHLESS IP56**

**29.500**

**WH36DC-W4Z**

Fuqia 36 V  
Moment rrotullimi 215 Nm  
Gjatesia 114 mm  
Pesha 1.6 kg  
Regjistrimi i forces 5 pozicione  
Sistemi i goditjes Triple Hammer  
Motor Pa karboncina Vetem trup



**MATRAPIK SDS-MAX 36V**

Compatible **BRUSHLESS**

**69.000**

**DH36DMA-W2Z**

Bateri 36 V  
Kapja SDS-Max  
Force goditese 7.1 J  
Kapaciteti shpimit Max Beton 40 mm  
Motori Pa karboncina Vetem trup



**MATRAPIK SDS-PLUS 36V**

**IRI** Me 3 funksione

**49.900**

**DH3628DA-W4Z**

Bateri 36 V  
Kapja SDS-Plus  
Force goditese 3.2 J  
Kapaciteti shpimit 28 mm  
Motori Pa karboncina  
Pesha 3.2 kg

**BRUSHLESS UVP**

**MATRAPIK SDS-PLUS 36V**

**BRUSHLESS**

**39.900**

**DH36DPA-W2Z** Me 3 funksione

Bateri 36 V  
Kapja SDS-Plus  
Force goditese 3.0 J  
Kapaciteti shpimit Beton/ dru / metal 28 mm / 32 mm / 13 mm  
Motori Pa karboncina  
Pesha 3.9 kg  
Vetem trup

**BRUSHLESS RFC LVH**

**MATRAPIK SDS-PLUS 36V**

**BRUSHLESS**

**49.000**

**DH36DPE-W2Z** Me 3 funksione

Bateri 36 V  
Kapja SDS-Plus  
Force goditese 3.2 J  
Kapaciteti shpimit Beton /dru / metal 28 mm / 32 mm / 13 mm  
Motori Pa karboncina  
Pesha 3.6 kg  
Vetem trup

**BRUSHLESS RFC UVP**

**GURE FLEKSIBEL 36V**

**BRUSHLESS IP56**

**59.900**

**G3623DA-W4Z**

Bateri 36 V  
Disku 230 mm  
Nr rrotullimeve 5.300 / min  
Motor Pa karboncina  
Pesha 4.9 kg  
Vetem trup

Auto Mode  
Sistem frenimi  
Mbrojtje nga goditja



**GURE FLEKSIBEL 36V**

**BRUSHLESS**

**26.900**

**G3613DE-W2Z**

Bateri 36 V  
Disku 125 mm  
Nr rrotullimeve 10.000/min  
Motor Pa karboncina  
Pesha 3.1 kg  
Vetem trup

Reduktimi i perimetrit të dorezës (vetëm 146 mm)



1  
2  
3  
4  
5  
6  
7  
8  
9  
10



COMBO

PACKS

18V

## Gati për sulm!

Gjithmonë gati për të sulmuar me paketa kombinuere me shumë volt.

Zgjidhje për të gjitha projektet tuaja.



### KC18DE-WHZ (DH1826DA + WH18DC + G1813DA + DS18DE)

COMBO **3 BATERI**

Matrapik SDS-Plus DH1826DA  
Me bateri 18V  
Forca Goditese: 3.2 J

Vidiator me goditje WH18DC  
Kapja 1/4"  
Forca shtrenguese 210 Nm

Gur fleksibel G1813DA  
Me bateri 18V  
Disku 125 mm

Vidiator / Trapan DS18DE  
Forca shtrenguese 70 Nm.  
Motor pa karboncina

**BRUSH  
LESS**  
Brushless Motor

**IRI**



3.2 J  
18V

**LVH  
BRUSHLESS**

DH1826DA



70 Nm  
18V

WH18DC



XBSL1850MA



G1813DA  
125 mm  
18V



210 Nm  
18V

DS18DE

**99.500**

### KC18DD-WAZ

Set Vidiatoresh pa karboncina

- Vidiator / Trapan me bateri DS18DD - Force shtrengimi 55 Nm
- Vidiator me goditje WH18DD - Force shtrengimi 140 Nm

Ka te perfs hire: 2 Bateri 18 V / 5.0 Ah + Karikues, Valixhe plastike

COMBO **2 BATERI**



**BRUSH  
LESS**  
Brushless Motor



55 NM  
18V

DS18DD



140 NM  
18V

WH18DD

**39.500**



**VIDIATOR ME GODITJE**

**18V**

**IRI**

**TRIPLE  
HAMMER**

**BRUSHLESS  
IP56**



**22.900**

**WH18DC-W2Z**

Bateri 18 V  
Momenti rrotullimit 210 Nm  
Nr rrotullimeve 4000 rpm  
Motori Pa karboncina  
Vetem trup

**VIDIATOR ME GODITJE**

**18V**

**BRUSHLESS**



**29.900**

**WH18DD-WPZ**

Bateria 2 x 18 V / 5.0 Ah  
Kapja 1/4"  
Force shtrengimi 140 Nm  
Nr rrotullimeve 0 - 3.200 / min  
Motor Pa Karboncina  
Pesha 1.2 kg

**VIDIATOR ME GODITJE**

**18V**

**BRUSHLESS**



**17.900**

**WH18DA-WCZ**

Bateria 2 x 18 V / 2.0 Ah  
Kapja 1/4"  
Force shtrengimi 140 Nm  
Nr rrotullimeve 0 - 2,700 / min  
Motor Pa Karboncina

**VIDIATOR ME GODITJE**

**18V**

**11.500**

**WH18DSAL-U4**



Bateria 18 V  
Kapja 1/4"  
Force shtrengimi 145 Nm  
Nr rrotullimeve 0 - 2,600 / min  
Vetem trup

**PISTOLETE DADICEKESH 1/2"**

**18V**

**19.900**

**WR18DF-W2Z**



Bateri 18 V  
Forca shtrenguese max 220 Nm  
Kapja 1/2"  
Kapaciteti bullon M10-M16

**PISTOLETE DADICEKESH 1/2"**

**18V**

**BRUSHLESS  
RFC**

**39.900**

**WR18DH-W2Z**



Bateri 18 V  
Forca shtrenguese max 600 Nm  
Kapja 1/2"  
Kapaciteti bullon M10-M20

**VIDIATOR GIPSI ME BATERI**

**18V**

**IRI**

**BRUSHLESS  
RFC**

**35.900**

**W18DB-WCZ**



Fuqja 18V  
Nr rrotullimeve 18V 0-3000 rpm  
Kapja 1/4"  
(Vetem trup)

**VIDIATOR GIPSI ME BATERI**

**18V**

**IRI**

**BRUSHLESS  
RFC**

**35.900**

**W18DA-WCZ**



Bateri 18V  
Nr rrotullimeve 18V 0-5000 rpm  
Kapja 1/4"  
(Vetem trup)

## VIDIATOR / TRAPAN ME GODITJE 18V

**IRI** **BRUSHLESS**  
**RFC**

29.900

DV18DC-W2Z

Bateri 18 V  
Momenti rrotullimit 140 Nm  
Nr rrotullimeve 550/2.000 g/min  
Motori Pa karboncina  
Vetem trup



## VIDIATOR / TRAPAN ME GODITJE 18V

**IRI** **BRUSHLESS**  
**RFC**

19.900

DV18DE-W2Z

Bateri 18 V  
Momenti rrotullimit 70 Nm  
Nr rrotullimeve 550/2.000 g/min  
Motori Pa karboncina  
Vetem trup



## VIDIATOR / TRAPAN ME GODITJE 18V

**BRUSHLESS**

9.900

DV18DD-W2Z

Bateria 18 V  
Force shtrengimi 55 Nm  
Nr rrotullimeve 1,700 / min  
Motor Pa karboncina  
Vetem trup



## VIDIATOR / TRAPAN 18V

**IRI** **BRUSHLESS**  
**RFC**

33.900

DS18DE-WFZ

Bateri 2 x 18 V / 5.0 Ah  
Momenti rrotullimit 140 Nm  
Nr rrotullimeve 2000 rpm  
Motori Pa karboncina  
Vetem trup



## VIDIATOR / TRAPAN 18V

**IRI** **BRUSHLESS**  
**RFC**

27.900

DS18DC-W2Z

Bateri 18 V  
Momenti rrotullimit 140 Nm  
Nr rrotullimeve 2000 rpm  
Motori Pa karboncina  
Vetem trup



## VIDIATOR / TRAPAN 18V

**IRI** **BRUSHLESS**

26.900

DS18DD-WPZ

Bateria 2 x 18 V / 5.0 Ah  
Force shtrengimi 55 Nm  
Nr rrotullimeve 0 - 1700 / min  
Motor Pa Karboncina



## VIDIATOR / TRAPAN 18V

**BRUSHLESS**

19.900

DS18DD-WQZ

Bateria 2 x 18 V / 3.0 Ah  
Force shtrengimi 55 Nm  
Nr rrotullimeve 0 - 1700 / min  
Motor Pa Karboncina



## VIDIATOR / TRAPAN 18V

17.500

DS18DA-WCZ

Bateria 2 x 18 V / 2.0 Ah  
Force shtrengimi 50 Nm  
Nr rrotullimeve 1,400 / min  
Mandrino 2.0 - 13 mm



**MATRAPIK SDS-PLUS**

**18V**

**IRI**

**59.900**

**DH1826DA-WPZ**

Bateri 2 x 18 V / 5.0 Ah  
Kapja SDS-Plus  
Force goditese 3.2 J  
Nr rrotullimeve 0 - 950/min  
Motori Pa karboncina  
Pesha 3.7 kg

**BRUSHLESS**  
**RFC LVH**



**MATRAPIK SDS-PLUS**

**18V**

**57.900**

**DH18DBL-WPZ**

Bateri 2 x 18 V / 5.0 Ah  
Kapja SDS-Plus  
Force goditese 2.6 J  
Kapaciteti shpimit Max Beton 26 mm  
Motori Pa karboncina  
Pesha 3.6 kg

**BRUSHLESS**

**2 bateri 18 V / 5.0 Ah**



**MATRAPIK SDS-PLUS**

**18V**

**Me 2 funksione**

**36.900**

**DH18DPA-W2Z**

Bateri 18 V  
Kapja SDS-Plus  
Force goditese 1.3 J  
Nr rrotullimeve 0 - 1,080/min  
Motori Pa karboncina  
Pesha 2.3 kg  
Vetem trup

**BRUSHLESS**  
**RFC LVH**



**SHARRE HEKURI**

**18V**

**BRUSHLESS**

**47.900**

**CB18DBL-W4**

Bateria 18 V  
Kapaciteti prerjes 83 mm  
Pesha 3.6 kg  
Motor

Pa karboncina  
Vetem trup

**Motor pa karboncina**

**83 mm**



**GURE FLEKSIBEL**

**18V**

**BRUSHLESS**

**21.500**

**G1813DA-W2Z**

Bateria 18 V  
Disku 125 mm  
Nr rrotullimeve 8.000 rpm  
Motor Pa karboncina  
Pesha 2.6 kg  
Vetem trup



**GURE FLEKSIBEL**

**18V**

**IRI**

**BRUSHLESS**

**25.900**

**G1813DVE-W2Z**

Bateria 18 V  
Disku 125 mm  
Nr rrotullimeve 3.200 - 8.000 rpm  
Motor

Pa karboncina  
Vetem trup

**REOSTAT**



**SHARRE ME LAMA VERTIKALE**

**18V**

**ERE**

**25.900**

**CJ18DB-W2Z**

Bateria 18 V  
Kapacitet prerje 135 mm  
Sheqjtesia 0 - 2,500/min  
Vetem trup



**SHARRE ME LAMA VERTIKALE**

**18V**

**22.500**

**CJ18DA-W2Z**

Bateria 18 V  
Kapacitet prerje 135 mm  
Nr rrotullimeve 0 - 2,500/min

Vetem trup

**135 mm**

**0-2.500/min**





## SHARRE ME LAMA HORIZONTALE **18V**

**BRUSHLESS**

**21.500**  
**CR18DBL-W4Z**

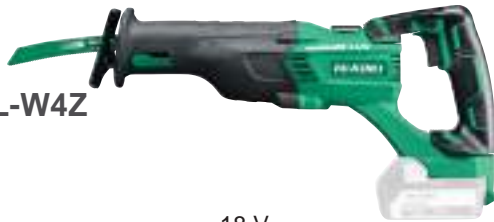

Bateria 18 V  
Kap. prerjes ne tub celiku 130 mm  
Kap. prerjes ne dru 120 mm  
Kap. prerjes ne pjate celiku 19 mm  
Vetem trup

**LVH**

## FREZE VERTIKALE **18V**

**BRUSHLESS**

**29.900**  
**M1808DA-W2Z**



Bateria 18 V  
Per punto freze 6 - 8 mm  
Thellesia max 40 mm  
Motor Pa Karboncina  
Me shpejtesi te ndryshueshme  
Rregullim i thellesise  
Vetem trup

**Ergonomi perfekte**

**40 mm thellesi max**

## SHARRE RRETHORE **18V**

**19.900**

**C18DSL-W4Z**



Bateria 18 V  
Disku 165 mm  
Kapaciteti max 90°: 57mm  
45°: 40mm  
Vetem trup

**165 mm**

**45° : 90°**

## SHARRE RRETHORE **18V**

**BRUSHLESS**

**17.900**

**C1806DA-W4Z**



Bateria 18 V  
Disku 165 mm  
Kapaciteti max 90°: 57 mm  
45°: 38 mm  
Vetem trup

**165 mm**

**45° : 90°**

## ZDRUKTH **18V**

**17.900**

**P18DSL-W4Z**



Bateria 18 V  
Gjeresi prerje 82 mm  
Thellesia prerje 2 mm  
Vetem trup

## GERSHERE LLAMARINE **18V**

**29.900**

**CE18DSL-W4Z**



Bateria 18 V  
Kapaciteti prerjes ne celik 1.6 mm  
Nr rrotullimeve 0-5.300 / min  
Pesha 2.0 kg  
Vetem trup



## PASTRUESE AJRI **BRUSHLESS 18V**

**E RE**

**14.500**  
**RA18DA-W4Z**



Bateria 18 V  
Shpejtesia ajrit 122 m/s  
Presioni max 18 kPa  
Motor Pa karboncina  
Pesha 1.1 kg  
Vetem trup

## RADIO KANTERI **18V**

**14.500**  
**UR18DSAL-W4**



Lidhje me smarphone  
Aux dhe USB  
Frekuenca: AM - FM  
2 bokse Ø 90 mm  
Shkalla e mbrojtjes: IPX4  
Perdoret me korent ose bateri  
Vetem trup

**IP X4**

**BOOSTER PACK**

**I RI**

**36V** ⚡ **18V** 

**29.900**

**UC18YSL3-WHZ**



SET ME 2 BATERI + KARIKUES  
MULTIVOLT  
BATERI LITHIUM 36 V - 2.5 AH  
18 V - 5 AH + KARIKUES  
Karikohet nga 35 - 60 min  
Mbrojtje nga mbingarkesa

**1.080 W**  
**18 V - 5.0 Ah**  
**36 V - 2.5 Ah**

**BOOSTER PACK**

**I RI**

**36V** ⚡ **18V** 

**39.900**

**UC18YSL3-WJZ**



SET ME 2 BATERI + KARIKUES  
MULTIVOLT  
BATERI LITHIUM 36 V - .0 AH  
18 V - 8.0 AH + KARIKUES  
Karikohet nga 35 - 60 min  
Mbrojtje nga mbingarkesa

**1.440 W**  
**18 V - 8.0 Ah**  
**36 V - 4.0 Ah**

**BATERI LITHIUM** **36V** ⚡ **18V**   
**36 V - 4,0 Ah / 18 V - 8 Ah**

**19.900**

**BSL36B18X**



36 V - 4.0 Ah / 18 V - 8.0 Ah  
Karikohet nga 32 min  
Mbrojtje nga mbingarkesa

**32 min**  
**18 V - 8.0 Ah**  
**36 V - 4,0 Ah**

**BATERI LITHIUM** **36V** ⚡ **18V**   
**36 V - 2,5 Ah / 18 V - 5 Ah**

**14.900**

**BSL36A18**



36 V - 2.5 Ah / 18 V - 5.0 Ah  
Karikohet nga 32 min  
Mbrojtje nga mbingarkesa

**32 min**  
**18 V - 5.0 Ah**  
**36 V - 2.5 Ah**

**BATERI LITIUM 18 V** **18V**

**13.500**

**BSL1850**



Bateri Litium  
Hikoki  
18V / 5.0 Ah

**BATERI LITIUM 18 V** **18V**

**9.900**

**BSL1840M**



Bateri Litium  
Hikoki  
18V / 4.0 Ah

**BATERI LITIUM 18 V** **18V**

**7.900**

**BSL1820M**



Bateri Litium  
Hikoki  
18V / 2.0 Ah

**KARIKUES BATERIE 18 / 36V**

**36V** ⚡ **18V** 

**I RI**

**7.900**

**UC18YKSL-W0Z**



Karikues baterie 36 V / 18 V  
Me shine  
3 A

1  
2  
3  
4  
5  
6  
7  
8  
9  
10

## MATRAPIK SDS-PLUS ME 3 FUNKSIONE

**17.900**

**DH24PH2-WSZ**

Fuqia	730 W
Force goditese	2.7 J
Kapaciteti beton/ celik/dru/gote betoni	24 mm 13 / 32 / 50 mm
Max goditjeve per min	3950 min
Pesha	2.7 kg

**730 W**

**2.7 J**



## MATRAPIK SDS-PLUS ME 2 MANDRINO

**22.500**

**DH24PMH-WSZ**

Fuqia	730 W
Force goditese	2.7 J
Mandrino	2 Quick
Motor	Horizontal
Kapaciteti beton/ celik/dru/gote betoni	3.4-24 mm 13 / 32 / 50 mm

**730 W**

**2.7 J**



## MATRAPIK SDS-PLUS ME 3 FUNKSIONE

**18.900**

**DH26PC2-WSZ**

Fuqia	830 W
Force goditese	2.9 J
Kapaciteti beton/celik/dru/ gote betoni	26/13/32 mm 50 mm
Pesha	2.8 kg

**830 W**

**2.9 J**



## MATRAPIK SDS-PLUS ME 2 MANDRINO

**23.900**

**DH26PMC-WSZ**

Fuqia	830 W
Force goditese	2.9 J
Mandrino	2 Quick
Motor	Vertikal
Pesha	3.0 kg

**830 W**

**2.9 J**



## MATRAPIK SDS-PLUS **BRUSHLESS**

**44.900**

**DH28PEC-WS** *RFC UVP*

Fuqia	900 W
Force goditese	3.4 J
Kapaciteti beton/celik/dru/ gote betoni	28/13/32 mm 50 mm
Motor	Pa karboncina
Pesha	3 kg

**900 W**

**3.2 J**



## MATRAPIK SDS-MAX

**45.900**

**DH40MC-WS**

Fuqia	1100 W
Force goditese	10.5 J
Kapaciteti shpimit Punto/gote	40 / 105 mm
Nr goditjeve	2.800/min
Pesha	7.1 kg

**1100 W**

**10.5 J**



## MATRAPIK SDS-MAX

**86.900**

*BRUSHLESS*

**DH45MEY-WS**

Fuqia	1500 W
Force goditese	13.4 J
Kapaciteti shpimit Punto/gote	45 / 125 mm
Gjatesia	535 mm
Nr goditjeve	120-260/min
Pesha	9.0 kg

**AHB**

**UVP**

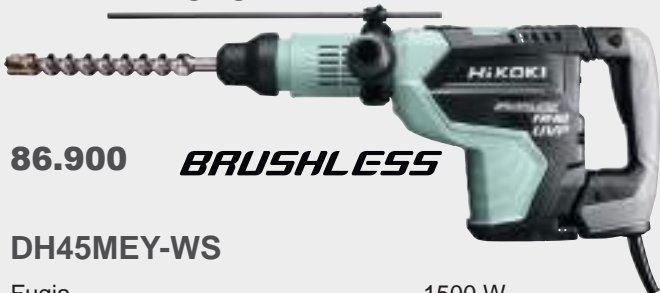

## MATRAPIK PER THYERJE

**99.900**

**H65SB3-WT**

Fuqia	1340 W
Nr goditjeve	1.400 / min
Forca goditese	42 J
Sistem antivibrimi	UVP
Gjatesia totale	731 mm
Pesha	18 kg

**AHB**

**UVP**





**GURE FLEKSIBEL**

**6.500**

**G13SR4-YGZ**



Fuqia	730 W	<b>730 W</b>
Nr rrotullimeve	10.000/min	
Disku	125 mm	<b>125 mm</b>
Gjatesia	258 mm	
Pesha	2.3 kg	

**GURE FLEKSIBEL**

**9.900**

**G13SB4-YGZ**



Fuqia	1400 W	<b>1400 W</b>
Nr rrotullimeve	11.000/min	
Disku	125 mm	<b>125 mm</b>
Gjatesia	283 mm	
Pesha	1.9 kg	

**GURE FLEKSIBEL**

**11.900**

**G23ST-WAZ**



Fuqia	2000 W	<b>2000 W</b>
Nr rrotullimeve	6,600/min	
Disku	230 mm	<b>230 mm</b>
Gjatesia	469 mm	
Pesha	5.1 kg	

**GURE FLEKSIBEL ME CELES SIGURIE**

**12.900**

**G23SW2-W7Z**



Fuqia	2200 W	<b>2200 W</b>
Nr rrotullimeve	6.600/min	
Disku	230 mm	<b>230 mm</b>
Gjatesia	469 mm	
Pesha	5.1 kg	

**GURE FLEKSIBEL ME NDEZJE TE BUTE**

**13.900**

**G23SWU2-UG**



Fuqia	2200 W	<b>2200 W</b>
Nr rrotullimeve	6,600/min	
Disku	230 mm	<b>230 mm</b>
Gjatesia	469 mm	
Pesha	5.4 kg	

**GURE FLEKSIBE PA KARBONCINA**

**BRUSHLESS**

**36.900**

**G23BYE-WK**



Fuqia	2200 W	<b>2200 W</b>
Nr rrotullimeve	6,600/min	
Disku	230 mm	<b>230 mm</b>
Motor	Pa karboncina	
Pesha	4.2 kg	<b>230 mm</b>

**TRAPAN METALI**

**9.900**

**D10VST-NA**



Fuqia	450 W
Nr rrotullimeve	0-3.200 / min
Shpejtesi	E ndryshueshme
Kapaciteti celik / dru	10 / 25 mm
Pesha	1.2 kg

**VIDIATOR GIPSI ELEKTRONIK**

**21.900**

**W6V4-WAZ**



Fuqia	620 W
Nr rrotullimeve bosh	0-4.500/min
Kapja	1/4" hex
Gjatesia totale	294mm
Pesha	1.4 kg

1  
2  
3  
4  
5  
6  
7  
8  
9  
10

## PISTOLETE DADICEKESH 1/2"

**BRUSHLESS**

**39.900**

**WR16SE**

Fuqia 370 V  
Force shtrenguese max 360 Nm  
Kapja 1/2"  
Kapaciteti bullon 12 - 22 mm  
Gjatesia 228 mm  
Motor Pa karboncina  
Pesha 2.5 kg



## PISTOLETE DADICEKESH 3/4"

**BRUSHLESS**

**79.900**

**WR22SE-WA**

Fuqia 850 V  
Force shtrenguese max 620 Nm  
Kapja 3/4"  
Kapaciteti bullon 14 - 24 mm  
Motor Pa karboncina  
Pesha 4.6 kg



**AHB**

## PISTOLETE DADICEKESH 1"

**BRUSHLESS**

**99.000**

**WR25SE-WA**

Fuqia 900 V  
Force shtrenguese max 1000 Nm  
Kapja 1"  
Kapaciteti bullon 22 - 30 mm  
Motor Pa karboncina  
Pesha 7.7 kg



**AHB**

## SHARRE ME MAJE VERTIKALE

**14.900**

**CJ90VAST2-WA**

Fuqia 705 W  
Kapaciteti prerjes 90 mm ne dru  
Kendi i prerjes 45° Majtas / Djathtas  
Nr rrotullimeve 850 - 3,000/min  
Pesha 2.2 kg



## SHARRE RRETHORE

**14.500**

**C7SS-UT**

Fuqia 1.090 W  
Kendi i prerjes 45-90° 185 mm  
Nr rrotullimeve bosh 5.500 / min  
Gjatesia 291mm  
Pesha 3.4 kg



## ZDRUKTH ELEKTRIK

**17.500**

**P20SF-WA**

Fuqia 620 W  
Letra zmeriluese 82 mm  
Pesha 2.5 kg



## PERZIERESE KOLLI

**26.900**

**UM16VST2-UAZ**

Fuqia 1600 W  
Diametri i shufres 160 mm  
Pesha 5.7 kg



Fuqia 1.600 W

Mbrojtje termike

Shpejtësi e ndryshueshme

## PERZIERESE KOLLI ME 2 SHUFRA

**33.500**

**UM22VYST-UA**

Fuqia 1800 W  
Diametri i shufres 220 mm  
Pesha 6.4 kg



Fuqia 1.800 W

Fuqia Termike

2 koka përzierëse

Kontroll shpejtësie e rrotullimit



# Einhell

CORDLESS EXCELLENCE.

POWER X-CHANGE

DY PARTNERË. NJË MISION.  
PERFORMANCË MAKSIMALE.



EINHELL ËSHTË PARTNER KRENAR I EKIPIT  
MERCEDES-AMG PETRONAS F1 TEAM.

Official Tool Expert



AMG  
PETRONAS  
FORMULA ONE TEAM





42.57.242

TE-AG 18/115 + TE-CD 18/48 + TE-HD 18/20

Matrapik SDS-Plus  
Me bateri 18V  
Forca Goditese: 1.8 J

Vidiator / Trapan me goditje  
Me bateri 18V  
Forca shtrenguese 45 Nm

Gur fleksibel  
Me bateri 18V  
Disku 115 mm

Gur fleksibel  
Me bateri 18V  
Disku 115 mm

**COMBO 3 BATERI**



**IRI**



**POWER X-CHANGE**

**18 V**  
2x3.0Ah

**48 Nm**  
HIGH POWER

GRIND + DRILL + SCREW + CHISEL



**29.900**

42.57.238

TC-AG 18/115 + TC-CD 18/35

Gur fleksibel  
Me bateri 18V  
Disku 115 mm

Vidiator / Trapan me goditje  
Me bateri 18V  
Forca shtrenguese 35 Nm

**1.5 + 3.0 Ah**

**35 Nm**

**COMBO 2 BATERI**



**POWER X-CHANGE**

GRIND + DRILL + SCREW + CHISEL

**18 V**  
2x3.0Ah



**19.900**

### MATRAPIK SDS-PLUS 18 V

**TP-HD 18/26 D Li**

**19.900**

**45.142.70**

Fuqia  
Force goditese 2.6 J  
Shtrengimi 4 funksione  
Motor Pa karboncina  
Kap shpimit Max Beton 40 mm  
Vetem trup



### GURE FLEKSIBEL ME BATERI 18V

**TE-AG 18/115-2**

**7.500**

**44.311.66**

Bateri 18V  
Disku 115 mm  
Thellesia prerjes 28 mm  
Nr rrotullimeve 8.500 / min  
Vetem trup



### VIDIATOR / TRAPAN ME GODITJE 18V

**TP-CD 18/120 Li-i**

**12.900**

**45.143.10**

Fuqia 18 V  
Force shtrengimi 120 Nm  
Mandrino 13mm  
Motor Pa karboncina  
Mandrino Metalike  
Vetem trup



### VIDIATOR / TRAPAN ME GODITJE 18V

**TP-CD 18/80 Li-i**

**8.900**

**45.143.05**

Fuqia 18 V  
Force shtrengimi 80 Nm  
Mandrino 13mm  
Motor Pa karboncina  
Mandrino Metalike  
Vetem trup

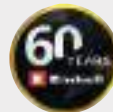

### VIDIATOR / TRAPAN ME GODITJE 18V

**TP-CD 18/50 Li-i**

**7.500**

**45.139.42**

Fuqia 18 V  
Force shtrengimi 50 Nm  
Mandrino 13mm  
Motor Pa karboncina  
Mandrino Metalike  
Vetem trup



### VIDIATOR / TRAPAN ME GODITJE 18V

**TP-CD 18/40**

**4.900**

**45.139.25**

Fuqia 18 V  
Force shtrengimi 40 Nm  
Mandrino 13mm  
Nr rrotullimeve 400-1500rpm  
Mandrino Metalike  
Vetem trup

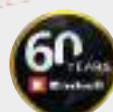

### VIDIATOR / TRAPAN ME BATERI 18V

**TE-CD 18/2 Li**

**9.990**

**45.142.31**

Bateri 2 x 18 V / 2.0Ah  
Force shtrengimi 44 Nm  
Mandrino 13mm  
Nr rotullimeve 400-1500rpm  
Mandrino Plastike



### VIDIATOR / TRAPAN ME BATERI 18V

**TC-CD 18/35-2 Li**

**6.990**

**45.142.55**

Bateri 1 x 18 V / 1.5Ah  
Force shtrengimi 35 Nm  
Mandrino 13mm  
Nr rotullimeve 400-1500rpm  
Mandrino Plastike



**VIDIATOR / TRAPAN 18 V**

**TE-CD 18/48 LiSolo**

**6.500**

**45.139.26**

**EXPERT**



Fuqia 18 V  
Force shtrengimi 48 Nm  
Mandrino 13 mm  
Motor Pa karboncina  
Nr rrotullimeve 0 - 1800 / min  
Vetem trup

**VIDIATOR / TRAPAN 18 V**

**TE-CD 18/40 Li-Solo**

**4.900**

**45.139.97**

**PUREPOWER**  
BRUSHLESS



Fuqia 18 V  
Force shtrengimi 40 Nm  
Mandrino 10 mm  
Nr rrotullimeve 0 - 1450 / min  
Motor Pa karboncina  
Vetem trup

**VIDIATOR / TRAPAN 18 V**

**TE-CD 18-2 Li**

**9.900**

**45.138.20**



Bateri 2 x 18 V / 1.3 Ah  
Force shtrengimi 38 Nm  
Mandrino 10 mm  
Nr rrotullimeve 0 - 1250 / min  
Pozicionet e rreg fuqise 19

**VIDIATOR ME GODITJE 18 V**

**TE-CI 18/1 LI-Solo**

**6.900**

**45.100.34**



Bateri 18 V  
Force shtrengimi 140 Nm  
Kapja 1/4"  
Nr rrotullimeve 0 - 2300 / min  
Vetem trup

**VIDIATOR GIPSI 18 V**

**TE-DY 18 Li Solo**

**8.500**

**42.599.80**



Bateri 18 V  
Kapja 1/2"  
Momenti rrotullimit 6 Nm  
Nr rrotullimeve bosh 4000 / min  
Vetem trup

**PISTOLETE DADICEKESH 18 V**

**IMPAXXO 18/400**

**14.900**

**45.100.70**



Bateri 18 V  
Force shtrengimi 400 Nm  
Kapja 1/2"  
Motor Pa karboncina  
Vetem trup

**PUREPOWER**  
BRUSHLESS

**PISTOLETE DADICEKESH 18 V**

**TE-CW 18 Li BL Solo**

**9.900**

**45.100.40**



Bateri 18 V  
Force shtrengimi 215 Nm  
Kapja 1/2"  
Motor Pa karboncina  
Nr rrotullimeve 0 - 1800 / min  
Vetem trup

**PUREPOWER**  
BRUSHLESS

**TRAPAN ME GODITJE 18 V**

**TE-ID 18 Li-Solo**

**6.990**

**45.139.60**



Bateri 18 V  
Kapja 1/2"  
Momenti rrotullimit 6 Nm  
Mandrino veteshtranguese 13 mm  
Vetem trup



### MATRAPIK SDS-PLUS 36 V

**HEROCCO 36/28**

**19.900**

**45.139.50**



Bateri 36 V  
 Force goditese 3.2 J  
 Momenti rrotullimit 29 Nm  
 Motor Pa karboncina  
 Kap shpimit Max Beton 28 mm  
 Vetem trup



### MATRAPIK SDS-PLUS 18 V

**HEROCCO 18/20**

**17.500**

**45.139.00**



Bateri 18 V  
 Force goditese 2.2 J  
 Momenti rrotullimit 18 Nm  
 Kapaciteti shpimit Max Beton 20 mm  
 Vetem trup

### MATRAPIK SDS-PLUS 18 V

**TE-HD 18 Li-Solo**

**9.900**

**45.138.12**



Bateri 18 V  
 Force goditese 1.2 J  
 Momenti rrotullimit 14 Nm  
 Mandrino veteshtrënguese 12 mm  
 Vetem trup

### POLIATRICE 18 V

**CE-CB 18/254 Li-Solo**

**5.900**

**20.933.01**



Bateri 18 V  
 Diametri 254 mm  
 Nr rrotullimeve 13 mm  
 Vetem trup

### GURE FLEKSIBEL 36 V

**AXXIO 36/230 Q**

**19.900**

**44.311.60**



Bateri 36 V  
 Disku 230 mm  
 Thellesia prerjes 70 mm  
 Nr rrotullimeve 6.600 / min  
 Vetem trup



### GURE FLEKSIBEL 18 V

**AXXIO 18/125 Q**

**9.900**

**44.311.51**



Bateri 18 V  
 Disku 125 mm  
 Thellesia prerjes 33 mm  
 Nr rrotullimeve 8.500 / min  
 Vetem trup



### TRONKATRICE 18 V

**TE-SM 36/210 Li - Solo**

**19.900**

**43.008.80**



Bateri 36 V  
 Nr i rrotullimeve 3800 rpm  
 Disku 210 x 30 mm

### ZMERILUESE MURI 18 V

**TP-DW 18/225 Li-Solo**

**14.500**

**42.599.90**



Bateri 18 V  
 Tamponi 225 mm  
 Nr rrotullimeve 1200 / min + aksesore  
 Vetem trup

1  
2  
3  
4  
5  
6  
7  
8  
9  
10

**FREZE DORE 18 V**

**TP-ET 18 Li BI-Solo**

**11.500**

**43.504.12**



Bateri 18 V  
 Per punto freze 6 / 8 mm  
 Kapja 10000 - 30000 min  
 Motor Pa karboncina  
 Shpejtesi E ndryshueshme  
 Vetem trup

**FREZE DORE ME BATERI**

**TP-RO 18 Set Li BL - Solo**

**21.500**

**43.504.10**



Tensioni 18 V  
 Thellesia max 40 mm  
 Lule freze 6 + 8 mm  
 Vetem trup

**SHARRE RRETHORE MINI 18 V**

**TE-CS 18/89 Li-Solo**

**8.900**

**43.311.00**



Bateri 18 V  
 Diametri i prerjes 89 mm  
 Nr rrotullimeve 3500 / min  
 Vetem trup

**SHARRE ME LAMA VERTIKALE 18 V**

**TC-JS 18 Li-Solo**

**4.900**

**43.212.09**



Bateri 18 V  
 Kapja 1/2"  
 Thellesia prerjes Dru 70 mm /  
 Plastik / Celik 10 / 8 mm  
 Nr rrotullimeve bosh 2700 / min  
 Vetem trup

**KAPERSE PER MAJA DHE GOZHDE 18 V**

**TE-CN 18 Li-Solo**

**9.900**

**42.577.90**



Bateri 18 V  
 Gozhde 16 - 22 mm  
 Maja 15 - 32 mm  
 Pesha 2.1 kg  
 Permban 300 maja / 300 gozhde  
 Vetem trup

**AJERNGROHESE 18 V**

**TE-HA 18 Li**

**5.500**

**45.205.00**



Bateri 18 V  
 Temperatura 350° - 550°  
 Pikimi 200 l/min  
 Pesha 0.6 kg  
 Vetem trup

**PISTOLETE SILIKONI 18 V**

**TE-SG 18/10 LI**

**6.990**

**45.222.50**



Bateri 18 V  
 Forca shtytese 2000 N  
 Shpejtesi 6 nivele  
 Kapaciteti 310 ml  
 Vetem trup

**ASPIRATOR 18 V**

**TE-VC 18/10 Li-Solo**

**5.990**

**23.471.60**



Bateri 18 V  
 Depozita 10 Lt  
 Presioni 90 bar  
 Vetem trup



**2 SHPEJTËSI (ECO/BOOST) PËR PËRDORIM OPTIMAL TË BATERISË**

**PERFORMANCË E LARTË E THITHJES ME LIRI PA KABLLO**

### ASPIRATOR 18 V

#### TE-VC 36/30 LI S



**14.900**

**23.471.40**



Motor 36 V  
 Depozita 30 L  
 Thithja 150 mbar/100mbar  
 Shpejtesia BOOST/ECO  
 Zorre thithje 250 cm  
 Vetem trup



**EXPERT**

### FRYRESE ME BATERI 18 V

#### CE-AP 18 Li-Solo

**3.290**

**20.701.10**



Bateri 18 V  
 Shpejtesia 670 L/min  
 Presion 0.053 bar  
 Pesha 0.4 kg  
 Vetem trup

### KARIKUES BATERIE

#### CC-BC 10 E

**4.990**

**10.508.21**



Voltazhi karikimit 12 V  
 Amperazhi 10-15A  
 Rryma e karikimit ne 12 V 7,1 / 10 A

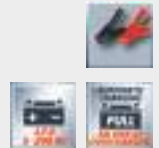

### KARIKUES STARTER / POWER BANK 12V

#### CE-JS 12/1

**14.900**

**10.915.21**



Voltazhi 12 V  
 Tensioni startit 2 - 10 A  
 Amperzhi / sec 200 A - 5 sec



### KARIKUES STARTER / POWER BANK 12V

#### CE-JS 18/1

**19.900**

**10.915.31**



Fuqja 350 W  
 Tensioni startit 2 - 10 A  
 Amperzhi / sec 300 A - 5 sec



### KARIKUES DHE STARTER BATERIE

#### CE-BC 15 M

**16.500**

**10.022.65**



Amperzhi 300 Ah  
 Voltazhi karikimit 12 V  
 Amperzhi / sec 100 A - 5 sec  
 Ekran LED



### KARIKUES DHE STARTER BATERIE

#### CE-BC 30 M

**21.900**

**10.022.75**



Amperzhi 600 Ah  
 Voltazhi karikimit 12/24 V  
 Amperzhi / sec 100 A - 5 sec  
 Ekran LED



1  
2  
3  
4  
5  
6  
7  
8  
9  
10



**VIDIATOR / TRAPAN ME BATERI**

**TH-CD 12-2 Li**

**5.500**

**45.136.60**



Bateria 1 x 12 V / 1.3 Ah  
 Momenti rrotullimit 24 Nm  
 Te perfshire Aksesore

**SET ZMERILUESE 7.2 V**

**TE-MT 7.2 Li**

**8.900**

**44.193.30**



Bateri 7.2 V / 1.5 Ah  
 Nr rrotullimeve bosh 5.500 - 26.000 / min  
 Aksesore 1.6 / 2.4 / 3.2 mm  
 Permban + 57 Aksesore

**VIDIATOR MINI 3.6V**

**TE-SD 3.6/1 Li**

**4.250**

**45.135.01**



Bateri 3.6 V  
 Momenti rrotullimit 4.5 Nm  
 Koha e karikimit 3 - 5 ore

**KAPESE TAPICERIE 3.6 V**

**TC-EN 20 E**

**5.990**

**42.578.80**



Bateri 3.6 V / 1.5 Ah  
 Per maja 6 - 14 mm  
 Perfshire (maja tipi 53) 1000 maja  
 Goditje / min 30 / min  
 Pesha 0.9 kg



**1 BATERI. 1000 MUNDËSI.**

Fuqia e baterisë për të zgjidhur cdo situatë.

Power X-Change është sistemi i parë i baterive që ofron një përzgjedhje të madhe mjetesh për koshtarët e pasionuar dhe ata që bëjnë vetë.

Mbi 250 makineri janë tashmë pjesë e familjes Power X-Change. Për t'ju ofruar liri wireless në akoma më shumë fusha të jetës. Falë baterisë së gjithanshme Power X-Change, pajisje të ndryshme tashmë "ushqehen me Power X-Change"



**BATERIA EINHELL 18V 4.0 AH POWER X-CHANGE**

Bateria Einhell 18V 4.0 Ah PXC është një bateri universale për të gjithë familjen e produkteve PXC është gjithashtu e përshtatshme për përdorim TWIN-PACK në aplikacionet 36V. Kjo siguron siguri maksimale, performancë optimale, kohëzgjatje maksimale dhe jetëgjatësi maksimale të shërbimit. Gjendja aktuale e karikimit mund të kontrollohet duke përdorur një ekran LED.

**4 Ah**



**100%**  
 Jetëgjatësi shërbimi

### SET ME 1 BATERI 5.2 AH

**5,2Ah & 4A Fast-charger**

**9.900**

**45.121.14**



Bateri  
Karikues  
1 x 5.2 Ah  
4 A te shpejtesi

### SET ME 2 BATERI 18 V / 4.0 AH

**2x18V 4,0Ah PXC-Twin-pack CB B1**

**11.900**

**45.114.89**



Bateri  
Fuqja  
Tensioni  
2 x 18 V / 4.0 Ah  
900 W  
220 - 240 V ~ 50-60 Hz  
Pa karikues

### SET ME 2 BATERI 18 V / 4.0 AH

**PXC Kit**

**IRI**

**17.500**

**45.121.12**



Bateri  
Fuqja  
Koha e karikimit  
2 x 18 V / 3.0 Ah + Karikues  
900 W  
60 min

### SET ME 2 BATERI 18 V / 3.0 Ah

**PXC Kit**

**READY TO GO IN 60 min**

**11.900**

**45.120.98**



Bateri  
Fuqja  
Koha e karikimit  
2 x 18 V / 3.0 Ah + Karikues  
2 x 900 W  
60 min

### SET ME 1 BATERI 18 V / 4.0 Ah

**PXC Kit**

**READY TO GO IN 75 min**

**7.500**

**45.120.42**



Bateri  
Fuqja  
Tensioni  
Koha e karikimit  
1 x 18 V / 4.0 Ah  
900 W  
220 - 240 V ~ 50-60 Hz  
75 min

### SET ME 1 BATERI 18 V / 2.5 Ah

**PXC Kit**

**READY TO GO IN 60 min**

**5.900**

**45.120.97**



Bateri  
Fuqja  
Koha e karikimit  
1 x 18 V / 2.5 Ah + Karikues  
2 x 720W  
60 min

### BATERI 18 V / 4.0 AH

**X-Xhange**

**IRI**

**5.900**

**45.113.99**



Bateri  
Fuqja  
Koha e karikimit  
18 V / 4.0 Ah  
Max 900 W  
75 min

### BATERI 18 V / 2.5 AH

**X-Xhange**



**45.115.05**

**4.900**



### BATERI 18 V / 2.0 AH

**X-Xhange**



**45.113.95**

**3.900**



**TRAPAN ME GODITJE**

**TC-ID 650 E**

**3.990**

**42.586.82**



Fuqia 650W  
Mandrino veteshtrenguese  
Rrotullimi 0 - 2600 rpm  
Pesha 1.8 kg

**CLASSIC**

**TRAPAN ME GODITJE**

**TC-ID 720/1 E**

**4.990**

**42.598.48**



Fuqia 720 W  
Mandrino veteshtrenguese  
Rrotullimi 0 - 2800 rpm  
Pesha 2.0 kg

**CLASSIC**

**VIDIATOR GIPSI ELEKTRIK**

**TH-DY500E**

**6.990**

**42.599.05**



Fuqia 500 W  
Pesha 1.65 kg  
Rrotullimi 0 - 2200 rpm

**MATRAPIK SDS-PLUS**

**TH-RH900/1**

**8.900**

**42.582.37**



Fuqia 900 W  
Forca goditese 3.0 J  
Kap max i shpimit beton 26 mm  
Pesha 4.3 kg

**CLASSIC**

**MATRAPIK SDS-PLUS**

**TH-RH1600**

**14.500**

**42.584.78**



Fuqia 1600 W  
Forca goditese 4 J  
Kap max i shpimit beton 32 mm  
Pesha 5.6 kg

**MATRAPIK SDS-MAX ME 3 FUNKSIONE**

**TE-RH 38 3F**

**19.900**

**42.579.59**



Fuqia 1050 W  
Force goditese 9 J  
Kapaciteti shpimit 38 mm  
Me valixhe + aksesore

**MATRAPIK SDS-MAX PER THYERJE**

**TE-DH 32**

**28.500**

**41.390.99**



Fuqia 1500 W  
Forca goditese 32 J  
Pesha 10.8 kg

**EXPERT**

**MATRAPIK HEXAGON PER THYERJE**

**TC-DH 43**

**27.900**

**41.390.87**



Fuqia 1600 W  
Forca goditese 43 J  
Aksi 30 mm  
Pesha 14.6 kg

**CLASSIC**



## GURE FLEKSIBEL

**TC-AG 750**

**3.900**

44.309.60



Fuqia 750 W  
Disku 115 mm  
Nr rrotullimeve 12000 rpm

## POLIATRICE

**CC-PO 1100/1E**

**9.900**

20.932.64



Fuqia 1100 W  
Tamponi 180 mm  
Nr rrotullimeve 1000-3500 rpm

## PISTOLETE DADICEKESH 1/2"

**CC-IW 450**

**7.900**

20.483.04



Fuqia 800 W  
Forca shtrenguese 300 Nm  
Nr rrotullimeve 2600/min

## FREZE E DREJTE ME 189 AKSESORE

**TH-MG135E**

**6.900**

44.191.69



Fuqia 135 W  
Nr i rrotullimeve 10000 - 35000 rpm  
Aksesoret 0,5 / 1,6 / 2,4 / 3,2 mm  
Pesha 0.65 kg

## ZMERILUESE BANGO

**TC-BAG 150**

**7.500**

44.126.32



Fuqia 150 W  
Disku 150 mm  
Ashpersia K36 / K60

## ZMERILUESE BANGO NGA 2 ANE

**TC-US 350**

**11.500**

44.661.54



Fuqia 350 W  
Disku 150 mm  
Ashpersia K36 / K80

## MATRAPIK HEXAGON PER THYERJE

**TE-DH 50**

**39.900**

41.391.30



Fuqia 1700 W  
Forca goditese 50 J  
Aksi 30 mm  
Pesha 18.4 kg

**PROFESSIONAL**

## TRONKATRIÇE METALI

**TC-MC 355**

**21.900**

45.031.35



Fuqia 2300 W  
Disku Ø 355 x 3.2 mm  
Nr i rrotullimeve 4000 rpm

1

2

3

4

5

6

7

8

9

10

**ZMERILUESE RRETHORE**

**TC-RS38E**

**5.900**

44.621.65



Fuqia 380 W  
Disku 125 mm  
Nr rrotullimeve 12000-26000 rpm

**ZMERILUESE DREJTEKENDORE**

**TE-OS2520E**

**7.900**

44.606.20



Fuqia 250 W  
Tamponi 230x115 mm  
Nr rrotullimeve 14000 - 24000 rpm

**ZMERILUESE MURI**

**TC-DW 225**

**21.900**

42.599.30



Fuqia 600 W  
Tamponi 225 mm  
Gjatesia 1100 - 1650 mm



**ZMERILUESE MURI**

**TE-DW 225**

**26.900**

42.599.60



Fuqia 750 W  
Disku 225 mm  
Gjatesia 1100 - 1650 MM

**VIDIATOR GIPSI ELEKTRIK**

**TC-DY 710 E**

**6.500**

42.599.25

**IRI**



Fuqia 710 W  
Kapja 1/4 "  
Nr rrotullimeve bosh 0 - 4000 rpm

**SHARRE ME LAMA VERTIKALE**

**TC-JS60/1**

**4.500**

43.211.35



Fuqia 400 W  
Kendi i prerjes 45°  
Nr rrotullimeve 500 - 3000 rpm

**SHARRE ME LAMA VERTIKALE**

**TC-JS 80/1**

**5.900**

43.211.45



Fuqia 550 W  
Tamponi 180 mm  
Nr rrotullimeve 1000-3500 rpm

**SHARRE ME LAMA VERTIKALE**

**TH-JS85**

**7.500**

43.211.40



Fuqia 620 W  
Kendi i prerjes 45°  
Nr rrotullimeve 800 - 3000 rpm

### TRONKATRICE ME SYPRINE

**TE-MS 216 T**

**36.900**

43.003.35



Fuqia 1500 W  
 Disku Ø216 x Ø30  
 Nr rrotullimeve / min 4500 / min

### TRONKATRICE ME SYPRINE

**TE-MS 254 T**

**49.000**

43.003.41



Fuqia 1500 W  
 Disku Ø254 x Ø30  
 Nr rrotullimeve / min 5000 / min

### TRONKATRICE ME SYPRINE

**TC-MS 3017 T**

**44.500**

43.003.47



Fuqia 2000 W  
 Disku Ø305 x Ø30  
 Nr rrotullimeve / min 4200 / min

### TRONKATRIÇE ME SHINE

**TC-SM 2524**

**34.900**

43.003.85



Fuqia 1900 W  
 Disku 254 x 30 mm  
 Nr rrotullimeve 5000 rpm

### TRONKATRICE

**TC-SY 500 P**

**11.900**

43.002.95



Fuqia 1600 W  
 Disku 210 mm  
 Hedhja 550 ml/min

### SHARRE RRETHORE

**TC-CS 1410**

**9.900**

43.310.50



Fuqia 1400 W  
 Disku 190 x 30 mm  
 Kendi i prerjes 45° - 90°

### SHARRE PLANI

**TC-SP 204**

**49.900**

44.199.55



Fuqia 1500 W  
 Nr rrotullimeve bosh 9000 min  
 Kendi 45°

### TORNO DRURI

**TC-WW 1000/1**

**25.900**

43.121.10



Fuqia 400 W  
 Gjatesia 1000 mm  
 Diametri max 280 mm

1  
2  
3  
4  
5  
6  
7  
8  
9  
10



**SHARRE NDERTIMI PORTATIVE**

**E RE**

**TC-TS 254**

**27.900**

43.405.10



Fuqia  
Disku  
Nr i rrotullimeve

2200 W  
Ø 254x30 mm  
4250 rpm

**SHARRE NDERTIMI PORTATIVE**

**TC-TS 2525/2 U**

**25.900**

43.404.90



Fuqia  
Disku  
Nr i rrotullimeve

1800 W  
Ø 254x30 mm  
4000 rpm

**SHARRE NDERTIMI PORTATIVE**

**TC-TS 254 ECO**

**23.900**

43.405.05



Fuqia  
Disku  
Kendi i prerjes

1800 W  
254x30 mm  
45°

**PRERESE PLLAKASH ME UJE**

**TC-TC 800**

**11.900**

43.011.85



Fuqia  
Disku  
Kendi i prerjes

800 W  
180 mm  
45°

**PRERESE PLLAKASH**

**RT-SC920L**

**69.900**

43.014.32



Fuqia  
Disku  
Gjatesia e prerjes

2200 W  
300 mm  
7 - 92 cm

**PERZJERESE KOLLI**

**TC-MX 1200 E**

**8.900**

42.585.45



Fuqia  
Shufer  
Nr rrotullimeve

1200 W  
194 mm  
0 - 680 rpm

**PERZJERESE KOLLI**

**TC-MX 1400-2 E**

**12.900**

42.585.50



Fuqia  
Shufer  
Nr rrotullimeve

1400 W  
210 mm  
0 - 780 rpm

**PERZJERESE KOLLI**

**TE-MX 1600-2 CE**

**14.500**

42.585.55

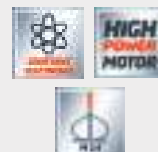

Fuqia  
Shufer  
Nr rrotullimeve

1600 W  
210 mm  
0-750 rpm

### TRAPAN BANGO

**TC-BD 350**

**16.900**

**42.506.70**



Fuqia 350 W  
Nr i rrotullimeve 580 - 2650 rpm  
Mandrino 13 mm

### TRAPAN BANGO

**TC-BD 450**

**18.900**

**45.205.92**



Fuqia 450 W  
Nr rrotullimeve 580 - 2650 rpm  
Mandrino 13 mm

### TRAPAN BANGO

**TC-BD 500**

**22.500**

**45.205.93**



Fuqia 500 W  
Lartesia 630 mm  
Mandrino 13 mm

### TRAPAN BANGO

**TC-BD 630**

**32.900**

**42.505.95**



Fuqia 630 W  
Lartesia 195 mm  
Mandrino 16 mm

### TRAPAN BANGO

**TE-BD 750 E**

**55.900**

**42.507.15**



Fuqia 750 W  
Lartesia 320 mm  
Mandrino 16 mm

### VINC ELEKTRIK

**TC-EH 250**

**14.900**

**22.551.30**



Fuqia 500 W  
Pesha mbajtese 250 kg  
Gjatesia e kavos 11.5 m

### VINC ELEKTRIK

**TC-EH 500**

**19.900**

**22.551.40**

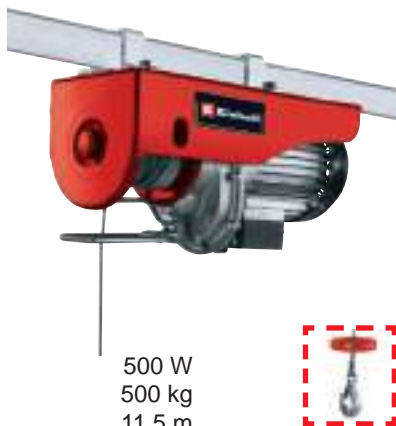

Fuqia 500 W  
Pesha mbajtese 500 kg  
Gjatesia e kavos 11.5 m

### VINC ELEKTRIK

**TC-EH 250**

**22.900**

**22.551.50**



Fuqia 1050 W  
Pesha mbajtese 600 kg  
Gjatesia e kavos 16 m

1  
2  
3  
4  
5  
6  
7  
8  
9  
10

**KRAH VINCI 830X90X100**

**SA1100**

**6.900**  
22.553.98



**KRIK ME DOPIO KRIKET 500 KG**

**TC-WI 500**

**4.500**  
22.601.60



**KRIK ME DOPIO KRIKET 800 KG**

**TC-WI 800**

**5.900**  
22.601.70



**PISTOLETE BOJE ELEKTRIKE**

**TC-SY 500 P**

**5.500**  
42.600.10



Fuqia  
Depozita  
Hedhja

500 W  
1000 ml poshte  
550 ml/min

**AJERNGROHESE**

**TH-HA2000/1**

**3.200**  
45.201.79



Fuqia 2000 W  
Temperatura 350-550°C rpm  
Fryrja 300 - 500 lt/ore

**PISTOLETE ME NGJITJE**

**TC-GG 30**

**1.900**  
45.221.70



Fuqia  
Koha e nxehtjes

30 W  
300 s  
+ 3 kallama rezerve

**KAPESE ELEKTRIKE PER MAJA**

**TC-EN 20 E**

**4.250**  
42.578.90



Tensioni 220-240 V | 50 Hz  
Goditje 20 goditje/min  
Kapese 6-14 mm



**KARROCE PER MBAJTJEN E VEGLAVE**

**TC-TW 100**

**19.900**  
45.101.70



Nr sirtareve  
Kapaciteti  
Me rrota

5 sirtare  
75 kg  
Me stop



### METER DISTANCE ME LAZER

**TC-LD 25**

**6.900**

**22.700.75**



Largesia matjes  
Klasi  
Marzhi i gabimit  
Dioda

0.05 m - 25 m  
II  
+/-3 mm  
635



### METER DISTANCE ME LAZER

**TC-LD 50**

**9.900**

**22.700.80**



Largesia matjes  
Klasi  
Marzhi i gabimit  
Dioda

0.05 m - 50 m  
II  
+/-2 mm  
635

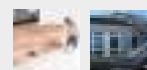

### METER DISTANCE ME LAZER

**TE-LD 60**

**14.500**

**22.700.85**



Largesia matjes  
Klasi  
Marzhi i gabimit  
Dioda

0.05 m - 60 m  
II  
+/-2 mm  
635



### NIVELUES KRYQ ME LAZER

**TC-LL 2**

**7.500**

**22.701.05**



Largesia matjes  
Koha e rregullimit  
Kendi i rregullimit  
Marzhi i gabimit

8 m  
5 sec  
4°  
+/-0.5 mm



### METER DISTANCE ME LAZER

**TC-LL 1**

**3.900**

**22.700.95**



Largesia matjes  
Klasi  
Marzhi i gabimit  
Dioda

0.05 m - 20 m  
II  
+/-2 mm  
650

### TRIPOD PER NIVELUES ME LAZER

**TRIPOD**

**3.900**

**22.701.15**



Lartesia  
Kapja

37-110 cm  
1/4"

### ASPIRATOR ASHKLASH

**TE-VE 550/1 A**

**32.900**

**43.041.56**



Fuqja  
Depozita  
Volumi  
Gjatesia e tubit

550 W  
65 lt  
1150 m<sup>3</sup>/h  
250 cm

### FILTER ASPIRATORI PER TH-VC 1820/1 S

**1.150**

**234221001032**



1

2

3

4

5

6

7

8

9

10



**FILTER PLUHURI I KLASIT L ACC.**  
 Per filtrimin e pluhurave të imët të suvasë,  
 shkumësit dhe patinimit.  
 Me sistem pastrimi filtri për rikthimin  
 e fuqisë thithëse.  
 Ndezje automatike per veglat.



**ASPIRATOR INOXI AUTOMATIKE FILTER L**

**TE-VC 2340 SACL**



Filter pluhuri i klasit L    Sistemi i shkundes se filtrit    Rregullator fuqie thithje    Thithje / Fryrje

**25.900**

**23.424.70**

Fuqia 1500 W  
 Depozita 40 lt  
 Materiali i depozites Inox  
 Fuqia e thithjes 225 mbar



**ASPIRATOR INOXI AUTOMATIKE FILTER L**

**TE-VC 2350 SACL**



Filter pluhuri i klasit L    Sistemi i shkundes se filtrit    Thithje / Fryrje    Ndezje automatike

**32.900**

**23.424.75**

Fuqia 1600 W  
 Depozita 50 lt  
 Materiali i depozites Inox  
 Fuqia e thithjes 230 bar



**ASPIRATOR INOXI**

**TH-VC 1820 S**

**8.500**

**23.421.67**

Fuqia 1250 W  
 Depozita 20 lt  
 Materiali i depozites Inox  
 Gjatesia e tubit 150 cm



**ASPIRATOR INOXI**

**TC-VC 1930 S**

**11.900**

**23.421.88**

Fuqia 1500 W  
 Depozita 30 lt  
 Materiali i depozites Inox  
 Gjatesia e tubit 250 cm



**ASPIRATOR INOXI**

**TE-VC 2230 SA**

**19.900**

**23.423.63**

Fuqia 1150 W  
 Depozita 30 lt  
 Materiali i depozites Inox  
 Fuqia e thithjes 220 mbar



**ASPIRATOR INOXI**

**TE-VC 2340 SA**

**22.500**

**23.423.80**

Fuqia 1200 W  
 Depozita 40 lt  
 Materiali i depozites Inox  
 Gjatesia e tubit 300 cm

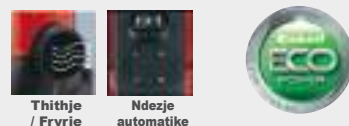



**INGCC**  
**SUPERLi**

**NEW**  
**4 AH**



**THE**  
**NEXT DIMENSION**  
**IN POWER™**

**OUR MOST <sup>†</sup> POWERFUL <sup>+</sup> MOST <sup>††</sup> EFFICIENT <sup>+</sup> LONGEST <sup>†††</sup> LIFESPAN**

**BATTERY IN ITS CLASS**



**VIDIATOR / TRAPAN ME GODITJE 20V**

**IRI** **138N.m**

**17.500**

**CIDLI20135**

Bateri 2 x 20 V / 2.0 Ah  
 Force shtrengimi 138 Nm  
 Nr rrotullimeve bosh 0-450/0-1900rpm  
 Motor Pa karboncina  
 Pozicionet e rreg 23 + 1 + 1  
 fuqise

**VIDIATOR / TRAPAN ME GODITJE 20V**

**IRI** **96N.m**

**14.500**

**CIDLI20958**

Bateri 2 x 20 V / 2.0 Ah  
 Force shtrengimi 96 Nm  
 Nr rrotullimeve bosh 0-450/0-1900/min  
 Motor Pa karboncina  
 Pozicionet e rreg 23 + 1 + 1  
 fuqise

**VIDIATOR / TRAPAN ME GODITJE 20V**

**IRI** **85N.m**

**12.500**

**CIDLI20808**

Bateri 2 x 20 V / 2.0 Ah  
 Force shtrengimi 85 Nm  
 Nr rrotullimeve bosh 0-450/0-1900/min  
 Motor Pa karboncina  
 Pozicionet e rreg 23 + 1 + 1  
 fuqise

**VIDIATOR / TRAPAN ME GODITJE 20V**

**70N.m**

**11.500**

**CIDLI20605**

Bateri 2 x 20 V / 2.0 Ah  
 Force shtrengimi 70 Nm  
 Nr rrotullimeve bosh 0-450/0-1900rpm  
 Motor Pa karboncina  
 Pozicionet e rreg 23 + 1 + 1  
 fuqise

**VIDIATOR / TRAPAN ME GODITJE 20V**

**60N.m**

**10.500**

**CIDLI20602**

Bateri 2 x 20 V / 2.0 Ah  
 Force shtrengimi 60 Nm  
 Nr rrotullimeve bosh 0-450/0-1900/min  
 Motor Pa karboncina  
 Pozicionet e rreg 23 + 1 + 1  
 fuqise

**VIDIATOR / TRAPAN ME GODITJE 20V**

**50N.m**

**9.500**

**CIDLI20508**

Bateri 2 x 20 V / 2.0 Ah  
 Force shtrengimi 50 Nm  
 Nr rrotullimeve bosh 0-450/0-1800rpm  
 Motor Pa karboncina  
 Pozicionet e rreg 18 + 1 + 1  
 fuqise

**VIDIATOR / TRAPAN ME GODITJE 20V**

**IRI** **45N.m**

**8.500**

**CIDLI201452**

Bateri 2 x 20 V / 2.0 Ah  
 Force shtrengimi 45 Nm  
 Nr rrotullimeve bosh 0-400/0-1500/min  
 Pozicionet e rreg 18 + 1 + 1  
 fuqise  
 Mandrino Metalike

**VIDIATOR / TRAPAN ME GODITJE 20V**

**IRI** **45N.m**

**4.900**

**CIDLI201455**

Bateri 20 V (Vetem trup)  
 Force shtrengimi 45 Nm  
 Nr rrotullimeve bosh 0-400/0-1500/min  
 Pozicionet e rreg 18 + 1 + 1  
 fuqise  
 Mandrino Metalike

**VIDIATOR / TRAPAN 20 V *BL MOTOR* 60N.m**

**9.500**
**CDLI20602**

Bateri 2 x 20 V / 2.0 Ah  
 Force shtrengimi 60 Nm  
 Nr rrotullimeve bosh 0-550/0-2000rpm  
 Motor Pa karboncina  
 Mandrino Metalike  
 Pozicionet e rreg 22 + 1  
 fuqise

**VIDIATOR / TRAPAN 20 V *BL MOTOR* 52N.m**

**8.500**
**CDLI20453**

Bateri 2 x 20 V / 2.0 Ah  
 Force shtrengimi 52 Nm  
 Nr rrotullimeve bosh 0-550/0-2000rpm  
 Motor Pa karboncina  
 Mandrino 10 mm  
 Pozicionet e rreg fuqise 22 + 1

**VIDIATOR / TRAPAN 20 V *BL MOTOR* 50N.m**

**8.500**
**CDLI20508**

Bateri 2 x 20 V / 2.0 Ah  
 Force shtrengimi 50 Nm  
 Nr rrotullimeve bosh 0-450/0-1800rpm  
 Motor Pa karboncina  
 +47 aksesore

**VIDIATOR / TRAPAN 20V 45N.m**

**7.500**
**CDLI200528**

Bateri 2 x 20 V / 2.0 Ah  
 Force shtrengimi 45 Nm  
 Nr rrotullimeve bosh 0-400/0-1500rpm  
 Pozicionet e rreg 18 + 1 + 1  
 fuqise

**VIDIATOR / TRAPAN 20 V**

**5.900**
**CDLI20518**

Bateri 1 x 20 V / 2.0 Ah  
 Force shtrengimi 45 Nm  
 Nr rrotullimeve bosh 0-400/0-1500rpm  
 Pozicionet e rreg 15 + 1  
 fuqise

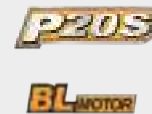
**VIDIATOR / TRAPAN 20 V**

**5.500**
**CDLI206021**

Bateri 20 V (Vetem trup)  
 Force shtrengimi 60 Nm  
 Nr rrotullimeve bosh 0-550/0-2000rpm  
 Motor Pa karboncina  
 Mandrino Metalike  
 Pozicionet e rreg 22 + 1  
 fuqise

**VIDIATOR / TRAPAN 20 V**

**4.500**
**CDLI204531**

Bateri 20 V (Vetem trup)  
 Force shtrengimi 52 Nm  
 Nr rrotullimeve bosh 0-550/0-2000rpm  
 Motor Pa karboncina

**VIDIATOR / TRAPAN 20 V**

**3.900**
**CDLI20515**

Bateri 20 V (Vetem trup)  
 Force shtrengimi 45 Nm  
 Nr rrotullimeve bosh 0-400/0-1500rpm  
 Pozicionet e rreg 15 + 1  
 fuqise



1  
2  
3  
4  
5  
6  
7  
8  
9  
10



**VIDIATOR ME GODITJE 20V 170N.m**
**BL MOTOR**
**10.900**
**CIRLI2002**

Bateri 2 x 20 V / 2.0 Ah  
 Force shtrengimi 170 Nm  
 Nr rrotullimeve bosh 0-1300/2100rpm  
 Kapja 1/4"

**VIDIATOR ME GODITJE 20V 285N.m**
**IRI**
**P20S BL MOTOR**
**11.900**
**CIRLI2028**

Bateri 2 x 20 V / 2.0 Ah  
 Force shtrengimi 285 Nm  
 Nr rrotullimeve bosh 0-1600/2600rpm  
 Kapja 1/4"

**PISTOLETE DADIÇEKESH 20V 220N.m**
**BL MOTOR**
**11.900**
**CIWLI20208**

Bateri 2 x 20 V / 2.0 Ah  
 Force shtrengimi 220 Nm  
 Nr rrotullimeve 0-13000/2100rpm  
 Kapja 1/2"+1/4"  
 Motor Pa karboncina

**PISTOLETE DADIÇEKESH 20V 300N.m**
**BL MOTOR**
**10.900**
**CIWLI2038**

Bateri 2 x 20 V / 2.0 Ah  
 Force shtrengimi 300 Nm  
 Nr rrotullimeve bosh 0-1300/0-2300rpm  
 Motor Pa karboncina  
 Kapja 1/2"  
 + 2 koka kriketi 19 / 21 mm

**PISTOLETE DADICEKESH 20V 400N.m**
**IRI**
**13.500**
**CIWLI2040**

Bateri 2 x 20 V / 4.0 Ah  
 Force shtrengimi 500 Nm  
 Nr rrotullimeve bosh 0-1300/  
 Nr rrotullimeve bosh 0-1900/0-2200rpm  
 Kapja 1/2"  
 Motor Pa karboncina

**PISTOLETE DADICEKESH 20V 500N.m**
**IRI**
**17.500**
**CIWLI2050**

Bateri 2 x 20 V / 4.0 Ah  
 Force shtrengimi 500 Nm  
 Nr rrotullimeve bosh 0-1300/  
 Nr rrotullimeve bosh 0-1900/0-2200rpm  
 Kapja 1/2"  
 Motor Pa karboncina

**PISTOLETE DADICEKESH 20V 850N.m**
**IRI**
**19.500**
**CIWLI2085**

Bateri 2 x 20 V / 4.0 Ah  
 Force shtrengimi 850 Nm  
 Nr rrotullimeve bosh 0-1400/  
 Nr rrotullimeve bosh 0-1900/0-2400rpm  
 Kapja 1/2"  
 Motor Pa karboncina

**PISTOLETE DADICEKESH 20V 1350N.m**
**IRI**
**BL MOTOR**
**22.900**
**CIWLI20135**

Bateri 2 x 20 V / 5.0 Ah  
 Force shtrengimi 1.350 Nm  
 Nr rrotullimeve bosh 0-1400/  
 Nr rrotullimeve bosh 0-1900/0-2400rpm  
 Kapja 1/2"  
 Motor Pa karboncina





### MATRAPIK SDS-PLUS 20 V ME 2 MANDRINO

**26mm**



**19.900**

**CRHLI202289**

Bateri 2 x 20 V / 4.0 Ah  
Force goditese 2.0 J  
Nr rrotullimeve 0-1100rpm  
Kap. shpimit max beton 26 mm  
Motor Pa karboncina  
+ 3 punto + 1 dalje

### MATRAPIK SDS-PLUS 20 V

**28mm**



**17.900**

**CRHLI202882**

Bateri 2 x 20 V / 4.0 Ah  
Force goditese 4.5 J  
Funksione 3 funksione  
Kap. shpimit max beton 28 mm  
Motor Pa karboncina

### MATRAPIK SDS-PLUS 20 V

**BL MOTOR**



**16.900**

**CRHLI202287**

Bateri 2 x 20 V / 4.0 Ah  
Force goditese 2.0 J  
Nr rrotullimeve 0-450/0-1900/min  
Kap. shpimit max beton 26 mm  
Motor Pa karboncina  
+ 3 punto + 1 dalje

### MATRAPIK SDS-PLUS 20 V **BL MOTOR** 22mm



**11.900**

**CRHLI202081**

Bateri 1 x 20 V / 4.0 Ah  
Force goditese 2.0 J  
Nr rrotullimeve 0-1100rpm  
Kap. shpimit max beton 22 mm  
4 Funksione  
+ 3 punto + 1 dalje

### MATRAPIK SDS-PLUS 20V

**BL MOTOR**



**8.900**

**CRHLI20228**

Bateri 20 V  
Force goditese 2.0 J  
Nr rrotullimeve 0-450/0-1900/min  
Kap. shpimit max beton 26 mm  
Motor Pa karboncina  
+ 3 punto + 1 dalje  
Vetem trup

### MATRAPIK SDS-PLUS 20 V

**BL MOTOR**



**12.500**

**CRHLI2201**

Bateri 20 V  
Force goditese 1.5 J  
Nr rrotullimeve 0-1350 rpm  
Kap. shpimit max beton 22 mm  
Motor Pa karboncina  
+ 3 punto + 1 dalje  
Vetem trup

### MATRAPIK SDS-PLUS 20 V **BL MOTOR** 22mm



**7.500**

**CRHLI20208**

Bateri 20 V  
Force goditese 1.5 J  
Nr rrotullimeve 0-1100rpm  
Kap. shpimit max beton 22 mm  
Motor 4 Funksione  
+ 3 punto + 1 dalje  
Vetem trup

### MATRAPIK SDS-PLUS 20V

**I RI**

**2 Function**



**5.500**

**CRHLI20168**

Bateri 20 V Trup  
Force goditese 1.5 J  
Nr rrotullimeve 0-850 rpm  
Kap. shpimit beton/  
celik/dru 16 mm/  
10 mm / 20mm  
+ 3 punto

1

2

3

4

5

6

7

8

9

10

**CKLI2019 (CIWLI2038+CDLI20051+CRHLI20228+CAGLI201158+CWLI2023+CWLI2023)**

Vidiator me goditje 20 V      Vidiator / Trapan 20 V      Matrapik SDS-Plus 20 V      Gure fleksibel 20 V      Ndricues 20 V  
 Forca shtrenguese 300 Nm      Forca shtrenguese 45 Nm      Force goditese 2.0 J      Disku 115 mm      150±10% Lumen

**I RI** **P20S**

x2  
4.0Ah

300 Nm

45 Nm

2.0 J

115 mm

120 Lm

x10

**BL MOTOR**

**34.500**

**CKLI20216 (CGSLI20581 + CIDLI20035 + CAGLI7601 + CWLI2023 + CGGLI2001 + CJSLI6508 + CABLI20018 )**

Sharre krasitese      Perese mini      Vidiator / Trapan      Fryrese gjethesh      Sharre vertikale      Pistoletë ngjitje      Ndricues 20 V  
 Shpata 13 cm      Disku 76 mm      20 V - 40 Nm      18000 rpm      Prerja ne dru 65mm      11.2mm      150±10% Lumen

**I RI** **P20S**

x2

35 cm

11.2 mm

40 mm

18000 rpm

76 mm

65 mm

120 Lm

Ø11mm x 20PCS

x4Pcs      x2Pcs      x1Pcs

**23.900**

**COSLI240202 (CIDLI20602 + CAGLI211156 + CRHLI20208)**

Trapan me goditje me bati-      Gure fleksibel me bateri      Matrapik SDS-Plus me bateri  
 eri, motor pa karboncina

**I RI** **P20S** **BL MOTOR**

x2

4.0Ah

115mm

2.0 J

x10

**23.900**

Cante veglash



**COSLI230708**

Combo Kit (Vidiator / Trapan me bateri + Vidiator me bateri)  
 - Vidiator / Trapan me bateri CDLI200528 - Force shtrenguese 45 Nm  
 - Vidiator me goditje me bateri CIRLI2017 - Kapja 1/4" - 170 Nm  
 Ka te perfshire: me 2 bateri 20 V / 2.0 + Karikues + Cante + aksesore

**IRI**



**12.500**



**CKLI2006**

Combo Kit (Vidiator / Trapan + Vidiator me Goditje motor pa karboncina) + 5 aksesore  
 - Vidiator / Trapan me bateri - Forza shtrenguese 45 Nm - Motor pa karboncina  
 - Vidiator me goditje - Kapja 1/4" - Forza shtrenguese 170 Nm  
 Ka te perfshire: me 2 bateri 20 V / 2.0 + Karikues + Cante



**14.500**



**COSLI230702**

Combo Kit (Vidiator / Trapan me bateri + Pistoletet dadicekesh me bateri)  
 - Vidiator / Trapan me bateri CDLI200528 - Force shtrenguese 45 Nm  
 - Pistoletet dadicekesh me bateri CIWLI2038 - Kapja 1/2" - 300 Nm  
 Ka te perfshire: me 2 bateri 20 V / 2.0 + Karikues + Cante + Aksesore

**IRI**



**12.500**



**COSLI230703**

Combo Kit (Ajerngrohese me bateri + Makineri MultiFunksionale me bateri)  
 - Ajerngrohese me bateri HGLI20025 - 300/550°C  
 - Makineri Multifunksionale me bateri CMLI2022 + aksesore  
 Ka te perfshire: me 1 bateri 4.0/ 1 bateri 2.0 Ah + Karikues + Cante

**IRI**



**12.500**



1  
2  
3  
4  
5  
6  
7  
8  
9  
10



**CKLI6015**

Combo Kit (Vidiator / Trapan me goditje + Gure fleksibel motor pa karboncina)  
 - Vidiator / Trapan me goditje CIDLI20608 - Forca shtrenguese 60 Nm - Motor pa karboncina  
 - Gure fleksibel me bateri CAGLI201158 - Disku 115 mm  
 Ka te perfshire: me 2 bateri 20 V / 4.0 + Karikues + Cante

**BL MOTOR** **P20S**



**25.500**



60 Nm

115 mm

**CKLI2009**

Combo Kit (Vidiator / Trapan me bateri + Gure fleksibel me bateri)  
 - Vidiator / Trapan me goditje me bateri CDLI20024 - Force shtrenguese 45 Nm  
 - Gure fleksibel me bateri CAGLI1151 - Disku 115 mm  
 Ka te perfshire: me 2 bateri 20 V / 4.0 + Karikues + Cante

**P20S**



**19.500**



45 Nm

115 mm

**CKLI20157**

Combo Kit (Vidiator / Trapan me bateri + Gure fleksibel me bateri)  
 - Vidiator / Trapan me bateri CDLI20051 - Force shtrenguese 45 Nm  
 - Matrapik me bateri CAGLI20157 - Disku 115 mm - Pa karboncina  
 Ka te perfshire: me 2 bateri 20 V / 4.0 + Karikues + Cante

**BL MOTOR** **P20S**



**15.900**



115 mm

45 Nm

**COSLI23011**

Combo Kit (Pistoletë Dadicekesh me bateri + Ndricues Mekaniku)  
 - Pistoletë Dadicekesh me bateri CIWLI2038 - Force shtrenguese 300 Nm  
 - Ndricues mekaniku me varje HWLI35261 + Adaptor 1/2 - 1/4"  
 - Set me 10 koka kriketi me goditje 1/2 + 10 maja PH2+SL6.0 65mm  
 Ka te perfshire: me 2 bateri 20 V / 2.0 + Karikues

**P20S** **BL MOTOR**

**IRI**



**11.900**



2.0Ah  
x2

### GURE FLEKSIBEL 20V

**BL MOTOR**

14.500

CAGLI2011582

Bateri  
Nr rrotullimeve bosh  
Diametri i diskut  
Kapja  
Motor



2 x 20 V / 4.0 Ah  
3000 / 8500 rpm  
115 mm  
M14  
Pa karboncina  
+ set me 10 disqe



x10  
x2

### GURE FLEKSIBEL 20V

12.500

CAGLI2011587

Bateri  
Nr rrotullimeve bosh  
Diametri i diskut  
Kapja  
Motor

**BL MOTOR**



1 x 20 V / 4.0 Ah  
3000 / 8500rpm  
115 mm  
M14  
Pa karboncina  
+ set me 10 disqe  
10x115 mm



x10  
x1

### GURE FLEKSIBEL 20V

**BL MOTOR**

**IRI**

13.500

CAGLI211542

Bateri  
Nr rrotullimeve bosh  
Diametri i diskut  
Kapja  
Motor



115mm(4-1/2")



2 x 20 V / 4.0 Ah  
3000 / 9000 rpm  
115 mm  
M14  
Pa karboncina  
+ set me 10 disqe  
10x115 mm

x10

### GURE FLEKSIBEL 20V

**BL MOTOR**

**IRI**

11.500

CAGLI2111561

Bateri  
Nr rrotullimeve bosh  
Diametri i diskut  
Kapja  
Motor



115mm(4-1/2")



1 x 20 V / 4.0 Ah  
3000 / 8000 rpm  
115 mm  
M14  
Pa karboncina  
+ set me 10 disqe  
10x115 mm

x10

### GURE FLEKSIBEL 20V

**BL MOTOR**

6.500

CAGLI201158

Bateri  
Nr rrotullimeve bosh  
Diametri i diskut  
Kapja  
Motor



20 V  
3000 / 8500 rpm  
115 mm  
M14  
Pa karboncina  
Vetem trup

**P20S**

### LUCIDUESE 20V

**BL MOTOR**

10.500

APLI2001

Bateri  
Nr rrotullimeve bosh  
Tamponi  
Motor



150mm

20 V  
500-2800 / min  
150 mm  
Pa karboncina  
Vetem trup

**P20S**

### POLIATRICE 20V

**BL MOTOR**

13.500

APLI2002

Bateri  
Nr rrotullimeve bosh  
Motor  
Tamponi



125mm

20 V  
2000-4800 / min  
Pa karboncina  
125 mm  
Vetem trup

**P20S**

### POLIATRICE DORE 20V

**P20S**

4.500

COPLI2001

Bateri  
Nr rrotullimeve bosh  
Tamponi



wool  
towel

254mm

20 V  
2500 rpm  
254 mm  
Vetem trup  
+ 1 leter per zmerilim druri + 1 per  
Vetem trup

1  
2  
3  
4  
5  
6  
7  
8  
9  
10



**ZMERILUESE RRETHORE 20V**
**P20S**
**ERE**
**125mm**
**8.500**
**CROSLI20011**

 Bateri  
 Nr rrotullimeve bosh  
 Tamponi  
 Leter zmerilimi

 1 x 20 V / 2.0 Ah  
 10.000 / min  
 125 mm  
 5 cope

**ZMERILUESE RRETHORE 20V**
**P20S**
**125mm**
**5.500**
**CROSLI2001**

 Bateri  
 Nr rrotullimeve bosh  
 Tamponi  
 Leter zmerilimi

 20 V  
 10.000 / min  
 125 mm  
 5 cope  
 Vetem trup

**ZMERILUESE TREKENDORE 20V**
**P20S**
**6.500**
**CDSLII20511**

 Bateri  
 Nr rrotullimeve bosh  
 Leter zmerilimi

 2 x 20 V / 2.0 Ah  
 13.000 / min  
 3 cope

**ZMERILUESE TREKENDORE 20V**
**P20S**
**4.500**
**CDSLII2051**

 Bateri  
 Nr rrotullimeve bosh  
 Leter zmerilimi

 20 V  
 13.000 / min  
 3 cope  
 Vetem trup

**TRONKATRICE 20V**
**P20S**
**18.500**
**CMS2001**

 Bateri  
 Nr rrotullimeve bosh  
 Diametri i diskut

 20 V  
 3000 / min  
 210 x 25.4 mm  
 Vetem trup

**VIDIATOR GIPSI 20V**
**BL MOTOR**
**IRI**
**11.500**
**CDSLII204200**

 Bateri  
 Force shtrengimi  
 Nr rrotullimeve bosh  
 Motor  
 Kapja

 1 x 20 V / 2.0 Ah  
 30 Nm  
 0-4200 rpm  
 Pa karboncina  
 1/4" hex

**SHARRE VERTIKALE 20V**
**P20S**
**6.900**
**CJSLI8501**

 Bateri  
 Nr rrotullimeve bosh  
 Kapaciteti prerjes

 20 V  
 2400 / min  
 Metal 8 mm  
 Dru 80 mm  
 Vetem trup

**SHARRE RRETHORE 20V**
**P20S**
**BL MOTOR**
**185mm**
**7.500**
**CSLI1851**

 Bateri  
 Disku  
 Prerja  
 Motor

 20 V  
 185 mm  
 45° - 90°  
 pa karboncina  
 Vetem trup



### SHARRE RRETHORE 20V

**140mm**

**ERE**

**9.900**

**CSLI14021**

Bateri  
Nr rrotullimeve bosh  
Diametri i diskut  
45°  
90°



1 X 20 V/4.0 Ah  
6300 rpm  
140 mm  
33 mm  
50 mm

### SHARRE RRETHORE 20V

**185mm**

**ERE**

**13.500**

**CSLI18511**

Bateri  
Nr rrotullimeve bosh  
Diametri i diskut  
45°  
90°



1 X 20 V/4.0 Ah  
4800 rpm  
185 mm  
45 mm  
65 mm

### SHARRE ME LAMA HORIZONTALE 20V

**8.900**

**CRSLI11521**

Bateri  
Nr rrotullimeve bosh  
Metal  
Dru



1 x 20 V / 2.0 Ah  
0 - 2800 rpm  
8 mm  
115 mm  
+ 2 Lama

### SHARRE ME LAMA HORIZONTALE 20V

**5.500**

**CRSLI1152**

Bateri  
Nr rrotullimeve bosh  
Metal  
Dru



20 V ( Vetem trup)  
0 - 2800 rpm  
8 mm  
115 mm  
+ 2 Lama

### SHARRE ME LAMA HORIZONTALE

**ERE**

**8.490**

**CRSLI65081**

Bateri  
Nr rrotullimeve  
Kapaciteti prerjes dru / metal



1 x 20 V / 2.0 Ah  
2400 rpm  
65 mm / 8 mm  
+2 lama (dru/metal)

### SHARRE SHIRIT METALI 20V

**127mm(5")**

**20.900**

**CBSLI20127**

Bateri  
Nr rrotullimeve bosh  
Kap maksimal i prerjes  
Lama prerjes



20 V  
0-120 m/min  
127 mm  
1141 mm  
x 13 mm x 0.65 mm  
Vetem trup

### MAKINERI MULTIFUNKSIONALE 20V

**IRI**

**6.990**

**CMLI20228**

Bateri  
Nr rrotullimeve bosh



2 x 20 V / 2.0 Ah  
5000-20000rpm  
Me 6 shpejtesi te ndryshueshme

### MAKINERI MULTIFUNKSIONALE 20V

**3.390**

**CMLI2022**

Bateri  
Nr rrotullimeve bosh  
Kendi lekundjes  
Aksesore



20 V  
5000-20000 rpm  
3.2°  
+ 8 cope  
Vetem trup

### PRERESE MINI 20V

**ERE**

6.900

CAGLI76012

Bateri  
N rrotullimeve bosh  
Disku  
Kapja  
Aksesore



1 x 20 V / 2.0 Ah  
19500/min  
76 mm  
M6  
10 cope

### VIBRATOR PLLAKASH 20V

8.990

CTVLI20101

Bateri  
Frekuenca e dridhjeve  
Diametri kupes thithese  
Forca e absorbimit  
Rregullimi i shpejtesise

1 x 20 V / 2.0 Ah  
0-10000 rpm  
125 mm  
50 kg  
12 nivele



### VIBRATOR BETONI 20V



Kodi	Permase	Çmimi
CCVLI2023013	Me 2 bateri 20 V / 2.0 Ah	11.500
CCVLI202301	Vetem trup	7.500

### AJERNGROHESE 20V

**ERE**

7.900

HGLI20025

Bateri  
Temperature

1 x 20 V / 2.0 Ah  
300/550°C  
+ aksesore



### NDRICUES KANTIERI 20V

**ERE**

1.450

CWLI2038

Bateri  
Llampa LED  
Ndricimi  
Autonomia



20 V  
5 W  
270±10%  
10 ore  
Vetem trup

### NDRICUES KANTIERI LED 20V



Kodi	Permase	Çmimi
CWLI20258	Me 1 bateri 20 V / 2.0 Ah	5.990
CWLI2025	Vetem trup	3.900

### PRESE KAPIKORDASH 20V

105.000

CTLI2002

Bateri  
Kapja  
Forca kapjes



2 x 20 V / 4.0 Ah  
16 - 400 m<sup>2</sup>  
120 KN

### PRERESE TUBASH HIDRAULIKE 20V

83.900

CRCLI2002

Bateri  
Diametri max i prerjes  
Forca shtrenguese  
Hapi levizjes

2 x 20 V / 4.0 Ah  
85 mm  
60 KN  
86 mm





### PERZJERESE KOLLI 20V

P20S

8.900

MXLI2001

Bateri  
Nr rrotullimeve bosh  
Kapja



Shpejtesia e ndryshueshme  
Vetem trup

20 V  
650 rpm  
M14

### DOREZE KRIKETI 20V

P20S

7.500

CDRLI206015

Bateri  
Kapja  
Koka kriketi  
Nr rrotullimeve bosh  
Force shtrengimi



1 x 20 V / 2.0 Ah  
3/8"  
13, 17, 19 mm  
0 - 250 rpm  
65 Nm  
+ Set me koka kriketi

### PISTOLETE SILIKONI 20V

254mm(10")  
3700N

**IRI**

10.500

CCGLI20011

Bateri  
Shpejtesia e shtytjes  
Volumi  
Force shtytese



1 x 20 V / 2.0 Ah  
0.5 mm - 4.4 m/s  
25,4 cm  
3700N

### PISTOLETE SILIKONI 20V

254mm(10")  
3700N

P20S

8.500

CCGLI2001

Bateri  
Shpejtesia e shtytjes  
Volumi



20 V  
0.5 mm - 4.4 m/s  
25,4 cm  
Vetem trup

### PERCINUESE 20V

BL MOTOR P20S

19.900

CRTLI20051

Bateri  
Forca terheqese  
Hapi terheqes



1 x 20 V / 2.0 Ah  
20 kN  
25 mm / goditje  
+ 100 percina

### PERCINUESE 20V

P20S

17.500

CRTLI2005

Bateri  
Forca terheqese  
Hapi terheqes



20 V  
20 kN  
25 mm / goditje  
Vetem trup

### PISTOLETE GOZHDESH 20V

P20S

**E RE**

17.500

CBNLI3606

Bateri  
Nr shkrepjeve / sekonde  
Gozhda



1 x 20 V / 2.0 Ah  
3 gozhde/sec  
F10-35

### PISTOLETE GOZHDESH 20V

P20S

**E RE**

14.500

CBNL3508

Bateri  
Nr shkrepjeve / sekonde  
Gozhda



1 x 20 V / 2.0 Ah  
3 gozhde/sec  
F15-50

1

2

3

4

5

6

7

8

9

10



### KOMPRESOR 20V

**ERE**

9.900

CACLI20021



Bateri  
Presioni

1 x 20 V / 2.0 Ah (12 DC)  
160 psi/11Bar  
Ndricimi LED

**160PSI**

### KOMPRESOR 20V

8.500

CACLI2002



Bateri  
Presioni  
Ndricimi LED

20 V, (12 DC)  
150 PSI  
Me 3 drita  
Vetem trup

**160PSI**

### FRYRESE GOMASH 20V

6.500

CACLI20011



Bateri  
Presioni  
Ka te perfshire

1 x 20 V / 2.0 Ah  
160 PSI / 60 BAR  
3 adaptore

**160PSI**

### FRYRESE GOMASH 20V

3.900

CACLI2001



Bateri  
Presioni  
Ka te perfshire

20 V  
160 PSI / 60 BAR  
3 adaptore  
Vetem trup

**160PSI**

### FRYRESE GOMASH 20V

**ERE**

2.900

CACLI2018



Bateri  
Presioni  
Ka te perfshire

Battery and  
charger sold  
separately

20 V  
50 PSI / 60 BAR  
3 adaptore  
Vetem trup

**150PSI**

### KOMPRESOR 20V

18.900

CACLI2003



Motori  
Depozita  
Presioni  
Prurje

40V  
by 2x 20V  
(20V+20V)  
6 Lt  
135 PSI  
98 L/min  
Vetem trup

**135PSI**  
6L

### PISTOLETE BOJE 20V

6.500

CSGLI20402



Bateri  
Presioni  
Max rrjedhjes  
Max viskozitetit  
Depozita

1 x 20 V / 2.0 Ah  
0.1 - 0.2 Bar  
600 ml / min  
120 DIN-s  
800 ml

**P20S**

### PISTOLETE BOJE 20V

4.900

CSGLI2001



Bateri  
Presioni  
Max rrjedhjes  
Max viskozitetit  
Depozita

20 V  
0.1 - 0.2 Bar  
600 ml / min  
40 DIN-s  
800 ml  
Vetem trup

**P20S**

### MINI ZMERILUESE 20V

P20S

8.500

CMGLI20011



Bateri  
Nr rrotullimeve bosh  
Shpejtësi  
Ka te pershire

1 x 20 V / 2.0 Ah  
5000-3300 rpm  
E ndryshueshme  
40 aksesore

### HAVI KALLAJI 20V

P20S

1.250

CSILI2001



Bateri  
Fuqia hyrese  
Koha e ngrohjes

20 V  
40 W  
3 - 5 min  
Koke me maje te drejte

### PISTOLETE NGJITJE 20V

5.900

CGGLI20018



Bateri  
Kapaciteti ngjitjes  
Diametri kallamave

1 x 20 V / 2.0 Ah  
15-18g/min  
11.2 mm  
+3 kallama ngjites

### PISTOLETE NGJITJE 20V

P20S

1.500

CGGLI2001



Bateri  
Kapaciteti ngjitjes  
Koha e ngrohjes  
Diametri i kallamit ngjites

20 V  
13 - 18 g / min  
60 sec  
11.2 mm  
Vetem trup

### PISTOLETE GRASO 20V

P20S

1000PSI

15.900

GGLI2010



Bateri  
Presioni  
Volumi / Prurja  
Gjatesia tubit  
Kapaciteti depozites

20 V  
10,000 psi (690 bar)  
282 g/min  
30" (76cm)  
411gr  
Vetem trup

### VENTILATOR 20V

P20S

4.900

CFALI2002



Bateri  
Voltazhi AC  
Nivele shpejtësie  
Kendi rrotullimit

20 V  
220-240V~50/60HZ  
2 nivele  
0-360°  
Vetem trup

### KARIKUES USB 20V

P20S

1.190

CUCLI2022



Bateri  
Pajisur me  
Me funksion

20 V  
USB  
LED  
Vetem trup

### RADIO KANTIERI 20V

P20S

4.900

CJRLI2001



Bateri  
Frekuence AM  
Frekuence FM

20 V  
522 - 1710 KHz  
87.5 - 108 MHz  
Vetem trup

1

2

3

4

5

6

7

8

9

10

### SET ME 4 BATERI 20 V / 5.0 AH



**25.500**

**FBCLI20245**

Bateri  
Permban  
4 x 20 V / 5.0 Ah  
Karikues i shpejtë inteligjent  
Ne kuti plastike  
Tregues LED per nivelin e baterise

### SET ME 4 BATERI 20 V / 4.0 AH



**18.900**

**FBCLI20244**

Bateri  
Permban  
4 x 20 V / 4.0 Ah  
Karikues i shpejtë inteligjent  
Ne kuti plastike  
Tregues LED per nivelin e baterise

### SET ME 6 BATERI 20 V / 2.0-4.0 AH



**16.900**

**COSLI230701E**

Bateri  
Permban  
**ERE** 4 x 20 V / 2.0 Ah / 2 X 20 V / 4.0 Ah  
Karikues i shpejtë inteligjent  
Ne kuti plastike  
Tregues LED per nivelin e baterise

### SET ME 2 BATERI 20 V / 5.0 AH



**11.900**

**FBCKP2425**

Bateri  
Permban  
2 x 20 V / 5.0 Ah  
Karikues i shpejtë inteligjent  
Ne kuti plastike  
Tregues LED per nivelin e baterise

### SET ME 2 BATERI 20 V / 4.0 AH



**9.900**

**FBCKP1424**

Bateri  
Permban  
2 x 20 V / 4.0 Ah  
Karikues i shpejtë inteligjent  
Ne kuti plastike  
Tregues LED per nivelin e baterise

### BATERI 20 V / 7.5 AH



**8.900**

**FBFI2075**

Bateri  
Niveli i karikimit  
20 V / 7.5 Ah  
Tregues LED per nivelin e baterise

### BATERI 20 V / 6.0 AH



**6.900**

**FBFI2060**

Bateri  
Niveli i karikimit  
20 V / 6.0 Ah  
Tregues LED per nivelin e baterise

### BATERI 20 V / 5.0 AH



**6.500**

**FBFI2003**

Bateri  
Niveli i karikimit  
20 V / 5.0 Ah  
Tregues LED per nivelin e baterise



**BATERI 20 V / 4.0 AH**

**P20S**

**5.500**

**4.0Ah**

**FBLI2002**



Bateri  
 Niveli i karikimit

20 V / 4.0 Ah  
 Tregues LED per  
 nivelin e baterise

**BATERI 20 V / 3.0 AH**

**P20S**

**3.500**

**3.0Ah**

**FBLI2030**



Bateri  
 Niveli i karikimit

20 V / 3.0 Ah  
 Tregues LED per  
 nivelin e baterise

**BATERI 20 V / 2.0 AH**

**P20S**

**2.900**

**FBLI2001**



Bateri  
 Niveli i karikimit

**2.0Ah**  
 20 V / 2.0 Ah  
 Tregues LED per  
 nivelin e baterise

**KARIKUES I SHPEJTE ME 6 PORTA**

**ERE**

**P20S**  
**6-PORT**

**4.0A**

**4.890**

**FCLI2064**



Bateri  
 Rryma e daljes

20 V  
 4 A  
 220-240V~50/60Hz  
 Gjashte porta aktive per  
 karikim baterie te njekohshem

**KARIKUES I DOPIO I SHPEJTE**

**ERE**

**4.190**

**FCLI2082**



Bateri  
 Rryma e daljes

20 V  
 8 A  
 220-240V~50/60Hz  
 Dy porta aktive per  
 karikim baterie te njekohshem

**KARIKUES DOPIO I SHPEJTE**

**P20S**

**4.0A**

**3.500**

**FCLI2034**



Bateri  
 Rryma e daljes

20 V  
 4 A  
 220-240V~50/60Hz  
 Dy porta aktive per  
 karikim baterie te njekohshem

**KARIKUES BATERIE 20 V**

**2.500**

**FCLI20411**



Bateri  
 Koha e karikimit  
 Voltazhi

20 V  
 30 min  
 220-240V~50/60Hz

**KARIKUES BATERIE 20 V I SHPEJTE QUICK**

**1.500**

**FCLI2001**



Bateri  
 Koha e karikimit

20 V  
 30 min

1

2

3

4

5

6

7

8

9

10

**VIDIATOR / TRAPAN 12V**
**25N.m**
**5.990**
**CIDLI1228**

Bateri 2 x 12 V / 1.5 Ah  
 Force shtrengimi 25 Nm  
 Nr rrotullimeve bosh 0-350/0-1350 rpm  
 Pozicionet e rreg fuqise 18 + 1 maje

**VIDIATOR / TRAPAN 12V**
**20N.m**
**3.500**
**CDLI1218**

Bateri 12 V / 1.5 Ah  
 Force shtrengimi 20 Nm  
 Nr rrotullimeve bosh 0-400/0-1500 rpm  
 Pozicionet e rreg fuqise 15 + 1 maje

**VIDIATOR / TRAPAN 12V**
**25N.m**
**5.500**
**CDLI1222**

Bateri 2 x 12 V / 1.5 Ah  
 Force shtrengimi 25 Nm  
 Nr rrotullimeve bosh 0-400/0-1500 rpm  
 Pozicionet e rreg fuqise 8 + 1 + 1

**VIDIATOR / TRAPAN 12V**
**20N.m**
**4.500**
**CDLI12202**

Bateri 2 x 12 V / 1.5 Ah  
 Force shtrengimi 20 Nm  
 Nr rrotullimeve bosh 0-400/0-1500 rpm  
 Pozicionet e rreg fuqise 15 + 1 maje

**VIDIATOR ME GODITJE 12V**
**7.900**
**CIRLI12015**

Bateri 2 x 20 V / 1.5 Ah  
 Kapja 1/4"  
 Nr rrotullimeve bosh 0-2000 rpm  
 Force shtrengimi 100 Nm  
 + Aksesore  
 Me fishe USB

**COMBO KIT 12 V**
**10.900**
**CKLI1203**

Bateri 2 x 12 V / 1.5 Ah  
 Trapan me bateri 12 V 45 Nm  
 Vidiator me goditje 12 V 170 Nm  
 + Ndricues + aksesore + cante

**VIDIATOR / TRAPAN 12V**
**20N.m**
**2.900**
**CDLI12428**

Bateri 1 x 12 V / 1.5 Ah  
 Force shtrengimi 20 Nm  
 Nr rrotullimeve bosh 0-750rpm  
 Pozicionet e rreg fuqise 15 + 1

**SET VIDIATOR 12V + 89 VEGLA DORE**
**5.900**
**HKTHP10891**

Bateri 1 x 12 V / 1.5 Ah  
 Sasia + 89 vegla dore  
 Valixhe Plastike  
 Me fishe USB

### ZMERILUESE MINI 12V

4.900

CMGLI12011



Bateria  
Nr rrotullimeve  
Kapja

1 x 12 V / 1.5 Ah  
8000-32000 rpm  
3.2 mm

### KOMPRESOR MAKINE 12V

5.490

AAC2508



Bateri  
Presioni max

20 V  
120PSI/8BAR  
Vetem trup

### KOMPRESOR 12V

5.500

CACLI12011



Bateria  
Presioni

1 x 12 V / 1.5 Ah  
160Psi/11Bar/1100Kpa  
+ 3 adaptore

### BATERI 12V

Kodi

Permasa

Çmimi

FBLI12153E

Bateri 12V/1.5 AH (CE)

1.450

FBLI12153

Bateri 12V/1.5 AH

1.350

### PISTOLETE NGJITJE 12V

750

CGGLI1201



Bateri  
Kapaciteti ngjitjes  
Perfshire

12 V  
15-18 g/min  
11 mm  
Vetem trup

### KARIKUES 12V

650

FCLI12071



KARIKUES 12V

890

CHAR228180

### BATERI 12V

1.500

FBLI12151



Bateri

12 V / 1.5 Ah  
Tregues LED per nivelin  
e baterise

### FISHE KARIKIMI USB PER MAKINERI

Kodi

Gjatesia

Çmimi

IUCC01

1 m

200

IUCC02

1 m

200

1  
2  
3  
4  
5  
6  
7  
8  
9  
10



### SET VIDIATOR 4V + 38 VEGLA DORE

3.500

HKTHP10381



Bateri  
Sasia  
Valixhe

4 V  
38 vegla dore  
Plastike

### VIDIATOR MINI 8V



3.390

CSDLI0802



Bateri  
Kapja  
Force shtrenguese  
Doreze e rregullueshme  
Nr rrotullimeve bosh

8 V  
1/4"  
6 Nm  
ne 2 nivele  
220 rpm

### VIDIATOR MINI 8V



2.690

CSDLI0406



Bateri  
Kapja  
Force shtrenguese  
Doreze e rregullueshme  
Nr rrotullimeve bosh

48 V  
1/4"  
5 Nm  
ne 2 nivele  
240 rpm

### VIDIATOR MINI 4V

1.790

CSDLI0442



Bateri

4 V  
+ aksesore

### KACAVIDE 4V

2.190

CSDLI0403



Bateri  
Kapja  
Force shtrenguese  
Nr rrotullimeve bosh

4 V  
1/4"  
5 Nm  
260 rpm  
+ Aksesore

### KACAVIDE 4V

2.900

CSDLI0413



Bateri  
Kapja  
Force shtrenguese  
Nr rrotullimeve bosh

4 V  
1/4"  
5 Nm  
260 rpm  
+ Aksesore

### NDRICUES KANTIERI 3.6V

5.900

HRLF4415



Bateri  
Ndricimi  
Autonomia

3.7 V  
900 Lm  
4 ore

### KARIKUES 5V



450

FCLI20502



Porta Karikimit  
Tensioni

Type A  
5V

### TRAPAN ELEKTRIK METALI 500 W

**2.900**

**ED50028**



**10mm**

Fuqia 500 W  
 Nr Rrotullimeve 0-3300 rpm  
 Mandrino me celes 10 mm  
 Me shpejtesi te ndryshueshme

### TRAPAN ELEKTRIK METALI 500 W

**2.900**

**ED500282**



**10mm**

Fuqia 500 W  
 Nr Rrotullimeve 0-3300 rpm  
 Mandrino veteshtrenguese 10 mm  
 Tensioni 220-240V~50/60Hz

### TRAPAN ME GODITJE 680 W

**2.900**

**ID6808**



Fuqia 680 W  
 Nr Rrotullimeve 0 - 3000 rpm  
 Mandrino me çeles 13 mm

### TRAPAN ME GODITJE 680 W

**3.500**

**ID68082**



Fuqia 680 W  
 Nr Rrotullimeve 0 - 3000 rpm  
 Mandrino veteshtrenguese 13 mm

### SET ME TRAPAN ME GODITJE 680 W + 115 VEGLA DORE **115PCS/SET**

**5.900**

**HKTHP11151**



Trapani 680 W  
 Sasia 115 vegla dore

### TRAPAN ME GODITJE 710 W **710W**

**I RI**

**3.500**

**ID7108**



**13mm**

Fuqia 710 W  
 Nr Rrotullimeve 0-3000 rpm  
 Mandrino veteshtrenguese 13 mm  
 Tensioni 220-240V~50/60Hz

### TRAPAN ME GODITJE 810 W

**3.900**

**ID8108**



Fuqia 810 W  
 Nr Rrotullimeve 0-2750 rpm  
 Mandrino me çeles 13 mm  
 Tensioni 220-240V~50/60Hz

### TRAPAN ME GODITJE 850 W

**4.500**

**ID8508**



Fuqia 850 W  
 Nr Rrotullimeve 0-2700 rpm  
 Mandrino me çeles 13 mm  
 Tensioni 220-240V~50/60Hz

1

2

3

4

5

6

7

8

9

10

### TRAPAN ME GODITJE 850 W

**4.900**

**ID8508-2**



Fuqia 850 W  
 Nr Rrotullimeve 0-2700 rpm  
 Mandrino veteshtrënguese 13 mm  
 Tensioni 220-240V~50/60Hz

### TRAPAN ME GODITJE 1100 W TRUP ALUMINI

**5.500**

**ID11008**



Fuqia 1100 W  
 Nr Rrotullimeve 0-2800 rpm  
 Mandrino me çeles 13 mm  
 Tensioni 220-240V~50/60Hz  
 Trup Alumini

### TRAPAN ME GODITJE 1100 W

**IRI**

**1100W**

**8.500**

**ID211008**



Fuqia 1100 W  
 Nr Rrotullimeve 1100-3000 rpm  
 Mandrino me çeles 16 mm  
 Tensioni 220-240V~50/60Hz  
 Trup Alumini

### MATRAPIK SDS-PLUS 650 W

**5.900**

**RGH6528**



Fuqia 650 W  
 Nr i rrotullimeve bosh 0-1700rpm  
 Forca goditese 1.7 J  
 Max shpimit: beton / metal / dru 26 / 13 / 30 mm  
 Punto SDS-Plus 3 cope

### MATRAPIK SDS-PLUS 800 W

**6.500**

**RGH9028**



Fuqia 800 W  
 Nr Rrotullimeve 0-1100 rpm  
 Forca goditese 2.5 J  
 Max shpimit: beton / metal / dru 26 / 13 / 30 mm  
 Punto + Dalta 3 / 2 Cope

### MATRAPIK SDS-PLUS ME 2 MANDRINO 800 W

**6.900**

**RGH9028-2**



Fuqia 800 W  
 Nr Rrotullimeve 0-1100 rpm  
 Forca goditese 2.5 J  
 Max Shpimit: beton / metal / dru 26 / 13 / 30 mm  
 Punto / Dalta 3 / 2 Cope

### MATRAPIK SDS-PLUS 950 W

**7.500**

**RGH9528**



Fuqia 950 W  
 Mandrino SDS-Plus  
 Forca goditese 2.5 J  
 Max shpimit: beton / metal / dru 28 / 13 / 30 mm  
 Nr. rrotullimeve 0 - 1.050 rpm

### MATRAPIK SDS-PLUS ME 2 MANDRINO 950 W

**8.500**

**RGH9528-2**



Fuqia 950 W  
 Mandrino SDS-Plus  
 Forca goditese 2.5 J  
 Max shpimit: beton / metal / dru 28 / 13 / 30 mm  
 Nr. rrotullimeve 0 - 1.050 rpm



### MATRAPIK SDS-PLUS ME MOTOR VERTIKAL 1050 W

**8.500**

**RH10506**

Fuqia 1.050 W  
 Forca goditese 4.5 J  
 Nr rrotullimeve 1100rpm  
 Max shpimit: beton / metal / dru 28 / 13 / 40 mm  
 Mandrino SDS-Plus



### MATRAPIK SDS-PLUS ME MOTOR VERTIKAL 1500 W

**1500W**

**I RI**

**9.900**

**RH150038**

Fuqia 1500W  
 Nr Rrotullimeve 950 rpm  
 Forca goditese 5.5 J  
 Max Shpimit: beton / metal / dru 32 / 13 / 40 mm  
 Punto / Dalta 3 / 2 Cope



### MATRAPIK SDS-PLUS ME MOTOR VERTIKAL 1500 W

**9.900**

**RH150028**

Fuqia 1500 W  
 Nr Rrotullimeve 850 rpm  
 Forca goditese 5.5 J  
 Max shpimit: beton / metal / dru 32 / 13 / 40 mm



### MATRAPIK SDS-PLUS ME MOTOR VERTIKAL 1500 W

**11.500**

**RH15008**

Fuqia 1500 W  
 Nr Rrotullimeve 750 rpm  
 Nr goditjeve 0 - 3000/min  
 Forca goditese 5 J



### MATRAPIK SDS-PLUS ME MOTOR VERTIKAL 1800 W

**11.500**

**RH18008**

Fuqia 1800 W  
 Nr Rrotullimeve 850 rpm  
 Forca goditese 7 J  
 Punt / Dalta 2 / 3 Cope



### MATRAPIK SDS-MAX ME MOTOR VERTIKAL 1600 W

**1600W**

**I RI**

**16.900**

**RH1600388**

Fuqia 1600 W  
 Nr Rrotullimeve 630 rpm  
 Forca goditese 10 J  
 Max Shpimit: beton / metal 40/100 mm  
 Punto / Dalta 2 / 2 Cope  
 Sistem Antivibrimi



### MATRAPIK SDS-MAX ME MOTOR VERTIKAL 1200 W

**34.500**

**RH1200428**

Fuqia 1200 W  
 Nr Rrotullimeve 35-514 rpm  
 Forca goditese 10 J  
 Max Shpimit: beton / metal / dru 28 / 13 / 40 mm  
 Punto / Dalta 3 / 2 Cope  
 Pesha 11 kg



### MATRAPIK SDS-MAX MOTOR VERTIKAL 1700 W

**I RI**

**55.500**

**RH1700558**

Fuqia 1700 W  
 Forca goditese 19 J  
 Nr rrotullimeve bosh 100-220rpm  
 Sistem antivibrimi I dyfishte  
 Shpimi beton dhe gote 55 mm / 150 mm



1

2

3

4

5

6

7

8

9

10

### MATRAPIK SDS-MAX PER THYERJE 1500 W

**25.500**

**PDB15006**

Fuqia 1500 W  
 Forca goditese 5-25 J  
 Nr Rrotullimeve 1000-1900 bmp  
 Punto / dalta hexagon 2 / 2 Cope  
 Pesha 10 kg



**SISTEM-ANTIVIBRIM**

### MATRAPIK HEXAGON PER THYERJE 1700 W

**19.900**

**PDB17008**

Fuqia 1700 W  
 Forca goditese 50 J  
 Nr Rrotullimeve 1400 bmp  
 Punto / dalta hexagon 2 / 2 Cope  
 Pesha 16 kg



**SISTEM-ANTIVIBRIM**

### MATRAPIK ME HEXAGON PER THYERJE 1300 W

**IRI**

**10.500**

**PDB130018**

Fuqia 1300 W  
 Nr Rrotullimeve 3800 bmp  
 Forca goditese 20 J  
 Pesha 7 Kg  
 Dalta hexagon 2 Cope



### MATRAPIK HEXAGON PER THYERJE 1700 W

**IRI**

**18.900**

**PDB17068**

Fuqia 1700 W  
 Forca goditese 50 J  
 Nr Rrotullimeve 1400 bmp  
 Dalte Hexagon 1 Cope  
 Pesha 14kg



**SISTEM-ANTIVIBRIM**

### MATRAPIK ME HEXAGON PER THYERJE 2200 W

**48.500**

**PDB22001**

Fuqia 1200 W  
 Nr Rrotullimeve 950 bmp  
 Forca goditese 75 J  
 Pesha 30 Kg  
 Me sistem anti vibrim



### ZMERILUESE MINI 130 W

**130W**

**3.500**

**MG13328**

Fuqia 130 W  
 Nr rrotullimeve 10000-35000/Min  
 Shpejtesi E ndryshueshme  
 Aksesore te perfshire 109 cope



### ZMERILUESE MINI 130 W

**130W**

**E RE**

**4.900**

**MG133281**

Fuqia 130 W  
 Nr rrotullimeve 10000-35000/Min  
 Shpejtesi E ndryshueshme  
 Aksesore te perfshire 252 cope



### ZMERILUESE MINI 200 W

**200W**

**E RE**

**4.990**

**MG2008**

Fuqia 200 W  
 Nr rrotullimeve 10000-40000/Min  
 Shpejtesi E ndryshueshme  
 Aksesore te perfshire 149 cope



### GURE FLEKSIBEL 710 W

**IRI**

**2.990**

**AG7118**



Fuqja 710 W  
 Disku 115 mm  
 Kapja M14  
 Nr i rrotullimeve 12000rpm  
 Tensioni 220-240V~50/60Hz

### GURE FLEKSIBEL 750 W

**3.290**

**AG75028**



Fuqja 750 W  
 Disku 115 mm  
 Kapja M14  
 Nr i rrotullimeve bosh 12000 rpm  
 Tensioni 220-240V~50/60Hz

### GURE FLEKSIBEL 900 W

**3.500**

**AG90028**



Fuqja 900 W  
 Disku 125 mm  
 Kapja M14  
 Nr. rrotullimeve 12000 rpm  
 Tensioni 220-240V~50/60Hz

### GURE FLEKSIBEL ME REOSTAT 900 W

**3.900**

**AG900285**



Fuqja 900 W  
 Disku 125 mm  
 Kapja M14  
 Nr i rrotullimeve bosh 5000-11000 rpm  
 Tensioni 220-240V~50/60Hz

### GURE FLEKSIBEL 950 W

**3.990**

**AG95018**



Fuqja 950 W  
 Disku 115 mm  
 Kapja M14  
 Nr i rrotullimeve bosh 11000 rpm  
 Tensioni 220-240V~50/60Hz

### GURE FLEKSIBEL 1100 W

**4.900**

**AG110018**



Fuqja 1100 W  
 Disku 125 mm  
 Kapja M14  
 Nr i rrotullimeve bosh 11000 rpm  
 Tensioni 220-240V~50/60Hz

### GURE FLEKSIBEL ME REOSTAT 1100 W

**5.500**

**AG1100385**



Fuqja 1100 W  
 Disku 125 mm  
 Kapja M14  
 Nr rrotullimeve 5000-12000rpm  
 Me shpejtesi Te ndryshueshme

### GURE FLEKSIBEL 1300 W

**5.900**

**AG130018**



Fuqja 1300 W  
 Disku 125 mm  
 Kapja M14  
 Nr i rrotullimeve bosh 12000 rpm  
 Tensioni 220-240V~50/60Hz

1

2

3

4

5

6

7

8

9

10



### GURE FLEKSIBEL 2000 W

**7.500**

**AG200028**

Fuqja 2000 W  
 Disku 230 mm  
 Kapja M14  
 Nr i rrotullimeve 6500rpm  
 Tensioni 220-240V~50/60Hz



### GURE FLEKSIBEL 2200 W

**8.990**

**AG220018**

Fuqja 2200 W  
 Disku 230 mm  
 Kapja M14  
 Nr i rrotullimeve bosh 6600 rpm  
 Tensioni 220-240V~50/60Hz



### GURE FLEKSIBEL 2400 W

**9.990**

**AG24008**

Fuqja 2400 W  
 Disku 230 mm  
 Kapja M14  
 Nr i rrotullimeve bosh 6300 rpm  
 Tensioni 220-240V~50/60Hz



### GURE FLEKSIBEL 2600 W

**11.900**

**AG26008**

Fuqja 2600 W  
 Disku 230 mm  
 Kapja M14  
 Nr i rrotullimeve bosh 6200 rpm  
 Tensioni 220-240V~50/60Hz



### POLIATRIÇE 1400 W

**1400W**

**7.490**

**AP140016**

Fuqja 1400 W  
 Tamponi 180 mm  
 Nr rrotullimeve 1500 - 3600 rpm



### POLIATRIÇE ME KONTROLL SHPEJTËSIE 1400 W

**9.900**

**AP140028**

Fuqja 1400 W  
 Tamponi 180 mm  
 Nr rrotullimeve 600 - 3200 rpm



### SHARRE MULTIFUNKSIONALE 750 W

**10.500**

**MFS1251**

Fuqja 750 W  
 Disku 125 mm  
 Nr i rrotullimeve bosh 4500 rpm  
 Kapaciteti i prerjes  
 Kend 45° 31 mm  
 Kend 90° 47 mm



### FREZE BISKOTASH 950 W

**9.900**

**BJ9508**

Fuqja 950 W  
 Lama 100 mm  
 Nr i rrotullimeve bosh 11,000 rpm  
 Permasa 400 x 175 x 185 mm  
 Tensioni 220-240V~50/60Hz



### SHARRE ME LAMA HORIZONTALE 800 W

**6.900**

**RS8008**



Fuqia 800 W  
Max prerjes Dru / Hekur / Alumin 115 / 8 / 12 mm  
Perfshire 1 lame druri / 1 lame hekuri  
Nr i rrotullimeve bosh 900-3300 rpm  
Lama 115 mm

### SHARRE ME LAMA HORIZONTALE 1200 W

**E RE**

**10.500**

**RS12001**



Fuqia 1200 W  
Max prerjes Dru / Celik 210 mm / 10 mm  
Nr i rrotullimeve bosh 1000~2800rpm  
Rregullimi i menyres prerjes Me 4 faza

### SHARRE ME LAMA VERTIKALE 570 W

**3.490**

**JS57028**



Fuqia 570 W  
Kapaciteti i prerjes 65 mm  
Lama rezerve 3 Cope  
Nr i rrotullimeve bosh 800-3000 rpm  
Me rregullim shpejtesie

### SHARRE ME LAMA VERTIKALE 650 W



**5.500**

**JS6508**



Fuqia 650 W  
Kapaciteti i prerjes Dru 80 mm / hekur 8 mm  
Lama rezerve 5 Cope  
Nr i rrotullimeve bosh 800-2800 rpm

### SHARRE ME LAMA VERTIKALE 800 W



**5.900**

**JS80028**



Fuqia 800 W  
Kapaciteti i prerjes dru/çelik 100/8 mm  
Lama rezerve 5 Cope  
Nr i rrotullimeve bosh 800-3000 rpm  
Me sistem te nxjerrjes se pluhurit

### SHARRE ME LAMA VERTIKALE 800 W



**6.900**

**JS80068**



Fuqia 800 W  
Kapaciteti i prerjes dru/çelik 135/10 mm  
Lama rezerve 5 Cope  
Nr i rrotullimeve bosh 800-3100 rpm  
Me sistem te nxjerrjes se pluhurit

### SHARRE RRETHORE 1200 W

**5.900**

**CS18578**



Fuqia 1200 W  
Disku 185x20 mm  
Nr Rrotullimeve 5000 rpm  
Kapaciteti prerjes 45° 45 mm  
Kapaciteti prerjes 90° 65 mm

### SHARRE RRETHORE 1400 W



**6.900**

**CS18538**



Fuqia 1400 W  
Disku 185 x 20 mm  
Kapaciteti prerjes 45° / 44 mm  
Nr i rrotullimeve bosh 4800 rpm  
Tensioni 220-240V~50Hz

1

2

3

4

5

6

7

8

9

10

### SHARRE RRETHORE 1600 W

**8.500**

**CS18568**



Fuqia 1600 W  
 Disku 185x20mm  
 Kapaciteti i prerjes 45° - 44 mm / 90° - 65 mm  
 Nr i rrotullimeve bosh 5000 rpm  
 Tensioni 220-240V~50/60Hz

### SHARRE RRETHORE 2200 W

**10.500**

**CS23522**



Fuqia 2200 W  
 Disku 235 x 25.4 mm  
 Nr rrotullimeve 4300 rpm  
 Kapaciteti prerjes 45° 65 mm  
 Kapaciteti prerjes 90° 80 mm

### SHARRE RRETHORE 2200 W

**13.500**

**CS2358**



Fuqia 2200 W  
 Disku 230 mm / 60 dhembe  
 Kapaciteti i prerjes 45° - 65 mm / 90° - 80 mm  
 Nr i rrotullimeve bosh 3800 rpm  
 Tensioni 220-240V~50/60Hz

### ZMERILUESE E DREJTE ME QAFE TE GJATE 400 W

**5.500**

**PDG4003**



Fuqia 400 W  
 Diametri 6 mm  
 Aksesore te perfshire 3 cope  
 Rrotullime / min 15000-26000 rpm  
 Tensioni 220-240V~50/60Hz

### ZMERILUESE KATRORE 240 W

**E RE**

**240W** 110x100mm

**3.900**

**PS2416**



Fuqia 240 W  
 Permasa 110mm x 100mm  
 Letra zmerilimi 5 Cope  
 Nr i xhirove 14000 rpm  
 Tensioni 220-240V~50/60Hz

### ZMERILUESE RRETHORE 320 W



**320W** Ø125mm

**4.500**

**RS3208**



Fuqia 320 W  
 Diametri 125 mm  
 Letra zmerilimi 5 Cope  
 Nr i rrotullimeve bosh 12000 rpm  
 Tensioni 220-240V~50/60Hz

### ZMERILUESE RRETHORE 450 W

**6.500**

**RS4508**



Fuqia 450 W  
 Diametri 150 mm  
 Letra zmerilimi 5 cope  
 Nr i rrotullimeve bosh 4000 - 13000 rpm  
 Tensioni 220-240V~50/60Hz

### ZMERILUESE DREJTEKENDORE 320 W



**4.500**

**FS3208**



Fuqia 320 W  
 Permasa 180 x 90 mm  
 Letra zmerilimi 5 Cope  
 Nr i xhirove 14000 rpm  
 Tensioni 220-240V~50/60Hz



### ZMERILUESE DREJTEKENDORE 350 W

**6.500**

**FS35028**

Fuqia 350 W  
 Permasa 110 x 220 mm  
 Letra zmerilimi 5 Cope  
 Nr i xhirove 11000 rpm  
 Tensioni 220-240V~50/60Hz



### ZMERILUESE TANK 1200 W

**14.500**

**PBS12001**

Fuqia 1200 W  
 Permasa 610 x 100 mm  
 Kapja M14  
 Nr i xhirove 5000-12000 rpm  
 Tensioni 220-240V~50/60Hz



### ZDUKTH ELEKTRIK 550 W

**4.500**

**PL5508**

Fuqia 550 W  
 Gjeresi dhe thellesi 82 x 1 mm  
 Nr xhirove 16000rpm  
 Me baze alumini



### ZDRUKTH PLANI 1050 W

**8.900**

**PL10508**

Fuqia 1050 W  
 Gjeresi dhe thellesi 82 x 3 mm  
 Nr i xhirove 16000 rpm  
 Sistem ftohje  
 Me baze alumini



### FREZE VERTIKALE 1600 W

**12.900**

**RT160028**

Fuqia 1600 W  
 Kapaciteti frezimit 0-60 mm  
 Nr i rrotullimeve bosh 22000 rpm  
 Permasa 6, 8, 12 mm, 1/4", 1/2"  
 Tensioni 220-240V~50/60Hz



### FREZE VERTIKALE 2200 W

**13.900**

**RT22008**

Fuqia 2200 W  
 Kapaciteti frezimit 0-60 mm  
 Nr i rrotullimeve bosh 9000-23000 rpm  
 Permasa 6, 8, 12mm, 1/4", 1/2"  
 Tensioni 220-240V~50/60Hz



### FREZE DORE PA BAZAMENT 600 W

**E RE**

**5.900**

**PLM6001**

Fuqia 600 W  
 Pinceta 6 mm dhe 1/4"  
 Kapja M6 / 6.4mm  
 Nr i xhirove 34500 rpm  
 Tensioni 220-240V~50/60Hz

**600W**



### TRONKATRIÇE METALI 2200 W **2200W**

**E RE**

**11.500**

**COS223558**

Fuqia 2200 W  
 Disku Ø 355 x 25.4 x 3 mm  
 Nr i rrotullimeve bosh 3700 rpm  
 Tensioni 220-240V~50/60Hz



1

2

3

4

5

6

7

8

9

10

### TRONKATRIÇE METALI 2400 W



**13.500**

**COS243558**

Fuqia 2400 W  
 Disku Ø 355 x 25.4 x 3 mm  
 Nr i rrotullimeve bosh 3900 rpm  
 Tensioni 220-240V~50/60Hz



### TRONKATRIÇE ME DISK 1400 W



**9.900**

**BMS14007**

Fuqia 1400 W  
 Disku Ø 210 x 25.4 mm  
 Nr i xhirove 5000 rpm  
 Trupi Alumini  
 Kapaciteti i prerjes 55 x 120 mm



### TRONKATRICE ME DISK 1800 W **1800W**



**21.900**

**BMS18001**

Fuqia 1800 W  
 Disku Ø255 mm x 30 mm  
 Max i prerjes 70 x140 mm  
 Nr i rrotullimeve bosh 5500 rpm



### TRONKATRIÇE ME DISK 1800 W



**21.900**

**BMS18007**

Fuqia 1800 W  
 Disku Ø 255 mm  
 Max i prerjes 70 x140 mm  
 Nr i rrotullimeve bosh 5500 rpm



### TRONKATRICE ME SHINE 1800 W **1800W**



**21.900**

**BM2S180017**

Fuqia 1800 W  
 Permasa 255 mm  
 Nr rrotullimeve bosh 5300 rpm  
 Tensioni 220-240V ~ 50 / 60Hz



### TRONKATRIÇE ME SHINE 2400 W



**39.900**

**BM2S24007**

Fuqia 2400 W  
 Disku Ø305  
 Max i prerjes 109 x 315 mm  
 Nr i xhirove 5000 rpm  
 Kendi Prerjes 45°



### TRONKATRICE ME SHINE DHE SYPRINE 1800 W



**41.500**

**MT2S18002**

Fuqia 1800 W  
 Disku Ø 305x30 mm  
 Max. i prerjes 90 x 305 mm  
 Nr. rrotullimeve bosh 3600 rpm



### SHARRE PLANI 1500 W



**35.500**

**JAP15001**

Fuqia 1500 W  
 Kapaciteti i frezimit 210 x 16.5 mm  
 Max prerjes 204 mm  
 Nr rrotullimeve 9000 rpm



### SHARRE BANGO 85 W



**13.500**

**SS852**

Fuqia 85 W  
 Sharra 133\*2.6\*0.25 mm  
 Nr i xhirove 0-1450 rpm  
 Thellesia e prerjes 50 mm  
 Gjeresia e prerjes 410 mm



### PLAN BANGO 1500 W



**41.500**

**TP15003**

Fuqia 1500 W  
 Gjatesia e prerjes 127 mm  
 Shpejtesia e sharres 9000r/min  
 Thellesia e prerjes 153 mm  
 Gjeresia e prerjes 318 mm



### SHARRE SHIRIT 350 W



**22.900**

**BAS3502**

Fuqia 350 W  
 Sharra 1511 mm  
 Shpejtesia e sharres 11.6m/s  
 Thellesia e prerjes 80 mm  
 Gjeresia e prerjes 230 mm



### PERZJERES KOLLI ME 2 SHUFRA 1800 W



**14.500**

**MX218008**

Fuqia 1800 W  
 Shufra 2 Cope  
 Nr Rrotullimeve bosh 180-480rpm / 250-650 rpm  
 Trupi Alumin  
 Shufer perzjerese 2 Cope



### PERZJERESE KOLLI 1400 W + SHUFER



**11.500**

**MX214008**

Fuqia 1400 W  
 Shufra 600 mm  
 Nr Rrotullimeve bosh 300-700 rpm  
 Trupi Alumin  
 Shufer perzjerese 1 Cope  
 Kapja M14



### PERZJERES KOLLI 1100 W

**1100W**



**6.900**

**MX11008**

Fuqia 1600 W  
 Nr Rrotullimeve bosh 0-680 rpm  
 Mandrino 16 mm  
 Shufer perzjerese 2 Cope



### SHUFER PERZJERESE PER MX218008



Kodi	Diametri	Çmimi
MX218008-SP-1-A	E djathte	<b>1.090</b>
MX218008-SP-1-B	E majte	<b>1.090</b>
MP1160	120 x 600 mm / M14	<b>1.550</b>
MP1120	160 x 600 mm / M14	<b>1.250</b>

### ZMERILUESE MURI 1050 W



**14.900**

**DWS10501**

Fuqia 1050 W  
 Tamponi 225 mm  
 Nr Rrotullimeve bosh 600-2300rpm  
 Ndricim led i inkoporuar



1

2

3

4

5

6

7

8

9

10



### SHARRE NDERTIMI PORTATIVE 1500 W

**ERE 1500W** Ø254mm

21.900

TS150078

Table size:  
730x638mm



Fuqia  
Disku

1500 W  
Ø 254 mm

### SHARRE NDERTIMI PORTATIVE 2600 W

**10"**  
Ø254mm

39.500

TS26005

Table size:  
549x643mm



Fuqia  
Disku

2600 W  
Ø 254 mm

### SHARRE NDERTIMI PORTATIVE 1500 W

**1500W** Ø254mm

39.900

TS15008



Table size:  
720x520mm

Fuqia  
Disku

1500 W  
Ø 254 mm

### PRERESE PLLAKASH 800 W

24.500

PTC8001



Kapaciteti Prerjes  
Disku  
Thellesia prerjes 45°-90°

620 mm  
200 x 25.4 mm  
29 mm - 36 mm

### PRERESE PLLAKASH 1100 W

28.500

PTC11002



Kapaciteti Prerjes  
Disku  
Thellesia prerjes 45°-90°

920 mm  
250 x 25.4 mm  
48 mm - 62 mm

### PRERESE PLLAKASH 2000 W

55.900

PTC20002



Kapaciteti Prerjes  
Disku  
Thellesia prerjes 45°-90°

1200 mm  
300 x 25.4 mm  
48 mm - 65 mm

### DISK DIAMANTI PER PRERESE PLLAKASH PTC8001

890

DMD022002



Permasa 200 x 25.4 mm

### DISK DIAMANTI PER PRERESE PLLAKASH PTC11002

1.590

DMD022501



Permasa 250 x 25.4 mm

### SHARRE MERMERI 1400 W

**5.900**

**MC14008**



Fuqia 1400 W  
 Disku 110 mm  
 Nr i xhirove 14500 rpm  
 Tensioni 220-240V~50/60Hz

### DISK DIAMANTI PER SHARRE MERMERI

**IRI**

**270**

**DMD011102**



Permasa

110 x 20 mm x 10 mm

### HAPESE KANALI 1500 W

**14.900**

**WLC15008**



Fuqia 1500 W  
 Thellesi prerjeje 8-30 mm  
 Disqe 4 Cope  
 Permasa 125 mm

### HAPESE KANALI ME UJE 3000 W

**21.900**

**WLC30001**



Fuqia 3000 W  
 Nr Rrotullimeve bosh 7000 rpm  
 Diametri i diskut 130 mm  
 Gjeresia prerjes 9 - 30 mm

### DISK DIAMANTI PER HAPESE KANALI

**550**

**DMD011254**



Permasa

125 x 22.2 x 7.5 mm

### DISK DIAMANTI PER HAPESE KANALI

**890**

**DMD011301**



Permasa

130 x 22 x 12 mm

### VINÇ ELEKTRIK 900 W

**18.500**

**EH5001**



Fuqia 900 W  
 Kapaciteti 500 Kg  
 Gjatesia e kavos 12 m

### VINÇ ELEKTRIK 1600 W

**41.900**

**EH10001**



Fuqia 1600 W  
 Kapaciteti 1000 Kg  
 Gjatesia e kavos 12 m

1

2

3

4

5

6

7

8

9

10

### TRAPAN KOLLONE BETONI 2800 W



**39.500**

**DDM28001**



Fuqia  
Per gota deri ne

2200 W  
200 mm

### TRAPAN KOLLONE BETONI 3800 W

**3800W**

**Ø230mm**

**IRI**

**44.900**

**DDM38001**



Fuqia  
Per gota deri ne

3800 W  
230 mm

### PISTOLETE DADICEKESH ELEKTRIKE 1/2" 1050 W

**11.900**

**IW10508**



Fuqia  
Force shtrengimi

1050 W  
550 Nm

### TRAPAN BANGO 350 W

**12.900**

**DP133505**



Fuqia  
Diametri i shpimit  
Nr i rrotullimeve bosh  
Lartesia  
Pesha

**13mm**

350 W  
13 mm  
580-2650 rpm  
590 mm  
19 Kg

### TRAPAN BANGO 750 W

**IRI**

**750W**

Max.drilling  
capacity:20mm

**36.500**

**DP207505**



Fuqia  
Kapaciteti max i shpimit  
Nr i rrotullimeve bosh  
Lartesia  
Pesha

750 W  
20 mm  
210-3200 rpm  
1570 mm  
50 Kg

### TRAPAN BANGO 1500 W

**49.500**

**DP3211001**



Fuqia  
Kapaciteti max i shpimit:  
Nr rrotullimeve bosh:  
Permasa  
Lartesia



1500 W  
32mm  
740-3140rpm  
425 x 475 mm  
1710 mm

### ZMERILUESE BANGO 150 W

**4.500**

**BG61502**



Fuqia  
Diametri

150 W  
150 mm



### ZMERILUESE BANGO 350 W

**7.590**

**BG83502**



Fuqia  
Diametri

350 W  
200 mm





### NGJITËSE PER TUBA PLASTIKE 800 W

**6.500**

**PTWT215002**



Fuqia 800 W  
 Diametri 22,25,32,40,50,63 mm  
 Termorregullatori 0-300°C

### MAKINERI MULTIFUNKSIONALE 300 W

**3.900**

**MF3008**



Fuqia 300 W  
 Nr rrotullimeve 10000-20000 r/min

### AJERNGROHESE 2000 W , 350°-550°

**2.250**

**HG2000385**



Fuqia 2000 W  
 Temperatura 350° - 550°  
 Fryrja 300 / 500 L/min

### AJERNGROHESE 2000 W 50° - 550° + AKSESORE

**E RE**

**2.490**

**HG200078**



Fuqia 2000 W  
 Nivele shpejtesie 3  
 Temperatura 50° - 550°  
 Ekran LED

### AJERNGROHESE 2000 W 50° - 550° + AKSESORE

**3.390**

**HG200047**



Fuqia 2000 W  
 Nr rrotullimeve 50° - 550°  
 Ekran LED

### AJERNGROHESE ME EKTRAN LCD 2000 W

**3.900**

**HG200058**



Fuqia 2000 W  
 Temperatura 50/50-600/50-600°C

### PISTOLETE BOJE ELEKTRIKE 450 W

**2.900**

**SPG3508**



Fuqia 450 W  
 Depozita 800 ml  
 Prurja 380 ml/min

### PISTOLETE BOJE ELEKTRIKE 500 W

**3.900**

**SPG5008**



Fuqia 500 W  
 Depozite alumini poshte 800 ml  
 Prurja 850 ml/min

1  
2  
3  
4  
5  
6  
7  
8  
9  
10

### PISTOLETE BOJE ELEKTRIKE

4.900

SPG5008-2



Fuqia 500 W  
 Depozite alumini poshte HVLP  
 Depozita 800 ml  
 Prurja 850 ml/min

### PISTOLETE NGJITJE 20W

690

GG148



Fuqia 20 W  
 Kallama ngjites 2 cope 150 mm  
 Kapaciteti ngjites 13 - 18 g/min

### PISTOLETE NGJITJE



Kodi	Permasa	Çmimi
GG258	25 W / 4 kallama 150 mm	1.190
GG308	30 W / 8 kallama 150 mm	1.590

### HAVI KALLAJI



Kodi	Permasa	Çmimi
SI0248	40 W	750
SI0268	60 W	890
SI00108	100 W	1.290

### HAVI KALLAJ 60 W

550

SI016831



Fuqia 60 W  
 Temperature E rregullueshme  
 Tensioni 220-240V~50/60Hz

### HAVI KALLAJ 100 W

890

SI0110831



Fuqia 100 W  
 Koha e nrehjes 20 sec  
 Tensioni 220-240V~50/60Hz  
 Temperature E rregullueshme

### HAVI KALLAJ STACIONARE 60 W

3.500

SI016911



Fuqia 60 W  
 Koha e nrehjes 1-2 min  
 Tensioni 220-240V~50/60Hz  
 Temperatura 200°- 480°

### HAVI KALLAJ STACIONARE 60 W

4.500

SI016923



Fuqia 60 W  
 Koha e nrehjes 1-2 min  
 Ekran Dixhital  
 Temperatura 200°- 480°

# Cilësi. Siguri. I verdhë.

Zgjidhjet Klingspor për  
industrinë e ndërtimit

**Klingspor**  
Abrasive Technology





# Cilësi. Siguri. I verdhë.

Klingspor është prodhuesi më i madh në produktet e prerjes dhe pastrimit i cili ka vendosur standarte të reja në teknologjinë e abraziveve prej 125 vitesh. Gama e produkteve përbehet nga mbi 50,000 produkte të dizenuara për të gjitha proceset: prerje, axhustim, pastrim dhe luçidim.

Klingspor mishëron cilësi premium, koncepte inovative dhe orjentim të palëkundur ndaj klientit.

## Produkte diamanti nga prodhimi i brendshëm



Për dekada, departamenti ynë i Kërkimit dhe Zhvillimit në Haiger, Gjermani, ka ngritur vazhdimisht flamurin në drejtim të përmirësimit të teknologjive të aplikuara në prerje dhe axhustim.

Specialistët e Haiger tani kanë hedhur gjithashtu themelet për aksesorët e diamantit që janë të pakrahasueshme në fushën e cilësisë dhe besueshmërisë.



## oSa

Ashtu si disqet tona prerëse dhe të pastrimit, aksesorët e diamantit të Klingspor-it përmbushin udhëzimet strikte të oSa dhe garantojnë të jenë në përputhje me standardin evropian të sigurisë - për siguri të përmirësuar gjatë përdorimit.



## Gama e produkteve tona: Po aq e shumëanshme sa edhe projekti juaj i ndërtimit

Çdo projekt ndërtimi mbart sfida të mëdha – si për përdoruesit ashtu edhe për mjetet e përdorura.

Një mori aplikimesh dhe materiale nga më të ndryshmet kërkojnë një portofol të gjerë produktesh. Përveç veglave klasike të diamantit për materiale me bazë minerale, ne në Klingspor ofrojmë një përzgjedhje të gjerë disqesh prerëse dhe axhustues për përpunimin e pothuajse të gjitha llojeve të materialeve që do të hasni në një kantier ndërtimi.



Më mirë akoma, të gjitha këto produkte plotësojnë standartet më të rrepta të cilësisë dhe sigurisë.

# Industritë e synuara

## Ndërtime objektesh



Punët e çative



Ndërtimi i objekteve

## Ndërtime nëntokësore



Shërbimet komunale, tubacionet dhe kabllot



Ndërtimi i rrugëve dhe linjave hekurudhore

## Përfundimet



Punimet e gipsit dhe instalimet elektrike



Shtrimi i pllakave dhe instalimeve hidraulike

1

2

3

4

5

6

7

8

9

10

# 3 LINJAT E PRODUKTIT

Mjeti i duhur për çdo kërkesë: Disqet e diamantit Klingspor janë të disponueshme në tre linja produktesh me shtatë kode ngjyrash për t'i ofruar përdoruesit një pasqyrë të shpejtë të materialeve më të rëndësishme për të cilat janë të përshtatshme.



## SPECIAL

Linja e produkteve 900 – aksesorë me performancë të lartë me performancë dhe jetëgjatësi të jashtëzakonshme. Për përdoruesit që kanë nevojë për mjetet e tyre për të performuar në kulmin e prodhimit dhe besueshmërisë edhe nëse i nënshtrohen aplikacioneve më ndëshkuese.



## SUPRA

Linja e produkteve 600 – vegla profesionale me një raport të jashtëzakonshëm çmim-performancë. Për përdoruesit që kërkojnë aksesorë diamanti që ofrojnë performancë të besueshme dhe të fuqishme çdo ditë.



## EXTRA

Product line 300 – markë cilësore me një çmim tërheqës. Për përdoruesit që presin që aksesorët e tyre të përmbushin standardet profesionale, por nuk kanë nevojë t'i përdorin ato vazhdimisht.



1.Klingspor kodit artikullit

2.Lloji dizenjos

3.Ngjyra e kodit

4.Piktograma e sigurisë

5.Shpejtësia maksimale e punimit

6.Klingspor logo

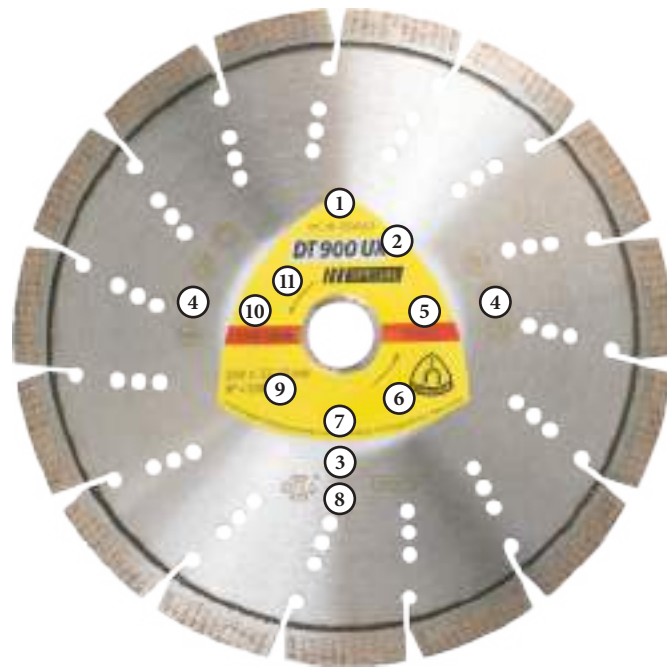

7.Informacion lidhur me prodhuesin

8.Standarti i sigurisë

9.Dimensioni në mm dhe inches

10.Shpejtësia maksimale e lejueshme e rrotullimit

11.Shigjeta e drejtimit rrotullues

### Sistemi i kodimit të ngjyrave të aksesorëve të diamantit Klingspor®

#### Asfalt

I zi



#### Pllakë

Jeshil



#### Gur/Kundër zjarrit

Blu



#### Beton

I kuq



#### Universal

I bardhë

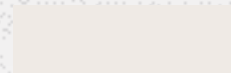

#### Metal

Gri



#### Aplikime speciale

I verdhë



### Piktograma në faqet e produktit



Aplikime ne te thate dhe te lagesht



Aplikime ne te lagesht



Aplikime ne te thate



Segment Konik



Pa zhurme, silencioz



Aplikime ne te lagesht



Aplikime ne te thate



Segment Turbo



Pa segment



Segment mbrojtës i pjerrët



Panel Sanduiçi



Set diamanti

Disqe Diamanti

## DT 600 G/U



Klasi i Performacës SUPRA

Aplikimet:

Agresiviteti	■ ■ ■ ■ ■ ■ ■ ■
Jetëgjatësia	■ ■ ■ ■ ■ ■ ■ ■

Granit	●
Terrazo	●

Avantazhet: Performancë e lartë prerje, jetëgjatësi e larte, prerje e pastër, cilësi e larte, e përshtatshme për të gjitha llojet e graniteve.

Kodi	Diameter në mm	Gjerësia në mm	V.max në m/s	Segment në mm	Max. RPM	Çmimi
336614	115	22.23	80	2.4	13300	<b>4.500</b>
336615	125	22.23	80	2.4	12200	<b>4.900</b>
336617	230	22.23	80	2.6	6600	<b>5.900</b>

Disqe Diamanti

## DT 612 UT

**NEW !**

Klasi i Performacës SUPRA

Aplikimet:

Agresiviteti	■ ■ ■ ■ ■ ■ ■ ■
Jetëgjatësia	■ ■ ■ ■ ■ ■ ■ ■

M.Konstruksioni	●
Beton	●
Beton i përforcuar	●
Ytong	●



- Segmente turbo
- 12 mm

Avantazhet: Segmente të veçanta turbo për një shpejtësi shumë të lartë të prerjes pothuajse në të gjitha materialet - qëndrueshmëri të mirë, madje edhe në beton të përforcuar.

Kodi	Diameter në mm	Gjerësia në mm	V.max në m/s	Segment në mm	Max. RPM	Çmimi
334044	115	22.23	80	2.4	13300	<b>3.500</b>
334045	125	22.23	80	2.4	12200	<b>4.500</b>

Disqe Diamanti

## DT 602 A

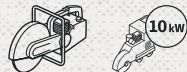

Klasi i Performacës EXTRA

Aplikimet:

Agresiviteti	■ ■ ■ ■ ■ ■ ■ ■
Jetëgjatësia	■ ■ ■ ■ ■ ■ ■ ■

Asfalt	●
Pllaka Guri	●

Avantazhet: Për çdo qëllim - Performancë prerje e shkëlqyer, raport i balancuar performancë - Çmim - Segmente Turbo dhe për skajet. Ideale për prerjen e asfaltit

Kodi	Diameter në mm	Gjerësia në mm	V.max në m/s	Segment në mm	Max. RPM	Çmimi
325060	300	25.4	100	18 / 40 / 2,8 / 10	6400	<b>12.900</b>
325092	350	25.4	100	21 / 40 / 3,2 / 10	5500	<b>14.900</b>
325128	450	25.4	100	28 / 40 / 3,7 / 10	4300	<b>22.900</b>
325171	500	25.4	100	30 / 40 / 3,7 / 10	3900	<b>24.900</b>
349228	400	20	100	24 / 40 / 3,6 / 10	4800	<b>14.900</b>
349240	400	25.4	100	24 / 40 / 3,6 / 10	4800	<b>18.900</b>

Disqe Diamanti

**DT900 FP**

Klasi i Performacës SPECIAL

Aplikimet:

 Agresiviteti 

 Pllaka dysHEMEJE 

 Jetëgjatësia 

 Porcelan 

 Pllaka muri 

 Pllaka guri 

 Qeramikë 

Avantazhet: Disk Extra i hollë për pllaka të forta dhe porcelan - Gjeometria e veçantë lejon shpejtësi të lartë pune dhe prerje perfekte.

Kodi	Diameter në mm	Segmenti në mm	V.max në m/s	Max. RPM	Çmimi
331039	115 x 22.23 x 1.4	CR/CR/1.4/10	80	13300	<b>3.900</b>
331040	125 x 22.23 x 1.4	CR/CR/1.4/10	80	13300	<b>4.200</b>

Disqe Diamanti

**DT 310 UT**

Klasi i Performacës EXTRA

Aplikimet:

 Agresiviteti 

 M.Konstruksioni 

 Jetëgjatësia 

 Beton 

 Tjegulla 

 • Segmente turbo  
• 12 mm

Avantazhet: Për çdo qëllim - Performancë prerje e shkëlqyer, raport i balancuar performancë - Çmim - Segmente Turbo dhe për skajet. Ideale për prerjen e tjegullave.

Kodi	Diameter në mm	Gjerësia në mm	V.max në m/s	Segment në mm	Max. RPM	Çmimi
334088	115	22.23	80	2	13300	<b>1.490</b>
334089	125	22.23	80	2	12200	<b>1.590</b>
334090	180	22.23	80	2.5	8500	<b>2.500</b>
334091	230	22.23	80	2.5	6600	<b>3.900</b>
334092	300	20 Dh	100	3	6400	<b>6.900</b>
334093	350	20 Dh	100	3	5500	<b>7.900</b>

Disqe Diamanti

**DT 350 U**

Klasi i Performacës EXTRA

Aplikimet:

 Agresiviteti 

 M.Konstruksioni 

 Jetëgjatësia 

 Beton 

Avantazhet: Për përdorim universal në të gjitha materialet e ndërtimit. Segmentet e salduar me lazer për prerje pa dridhje dhe jetëgjatësi të lartë. Raport optimal çmim-cilësi.

Artikulli	Diameter në mm	Gjerësia në mm	V.max në m/s	Segment në mm	Max. RPM	Çmimi
336214	115	22.23	80	2.4	13300	<b>2.500</b>
336215	125	22.23	80	2.4	12200	<b>2.900</b>
336216	180	22.23	80	2.6	8500	<b>3.500</b>
336219	230	22.23	80	2.6	6600	<b>5.500</b>



Disqe Diamanti

**DT 900 FL**

Klasi i Performacës SPECIAL

 Agresiviteti          

 Jetëgjatësia          

Aplikimet:

Pllaka dysHEMEJE	●
Pllaka muri	●
Porcelan	●
Qeramikë	●
Mermer	●

Avantazhet: I përshtatshëm për një gamë të gjerë aplikimesh - Shpejtësia e lartë e prerjes - Segment special për jetëgjatësi shërbimi dhe prerje të pastra - Projektuar për përdorim profesional

Kodi	Diameter në mm	Segmenti në mm	V.max në m/s	Max. RPM	Çmimi
331042	115 x 22.23 / 30	CR / CR / 1,4 / 7	80	13300	<b>2.900</b>
331043	125 x 22.23 / 30	CR / CR / 1,4 / 7	80	12200	<b>3.100</b>
331044	180 x 22.23 / 30	CR / CR / 1,6 / 7	100	10650	<b>4.500</b>
331045	180 x 25.4 / 30	CR / CR / 1,6 / 7	100	10650	<b>4.500</b>
331046	200 x 25.4 / 30	CR / CR / 1,6 / 7	100	9550	<b>5.500</b>
331048	230 x 25.4 / 30	CR / CR / 1,8 / 7	100	8350	<b>5.900</b>
331041	230 x 22.23 / 30	CR / CR / 1,8 / 7	80	6600	<b>5.900</b>
331047	250 x 25.4 / 30	CR / CR / 1,6 / 7	100	7600	<b>7.500</b>

Disqe Diamanti

**DT 900 U**

Klasi i Performacës SPECIAL

 Agresiviteti          

 Jetëgjatësia          

Aplikimet:

M.Konstruksioni	●	Granit	●
Beton	●	Instalime elektrike	●
Beton i përforcuar	●		

Avantazhet: I përshtatshëm për një gamë të gjerë aplikimesh - Shpejtësia e lartë e prerjes - Segment special për jetëgjatësi shërbimi dhe prerje të pastra - Projektuar për përdorim profesional

Kodi	Diameter x Gjerësia në mm	Segmenti në mm	V.max në m/s	Max. RPM	Çmimi
325045	230	15 / 42 / 2,6 / 12	80	6600	<b>7.500</b>
325067	300	21 / 40 / 2.8 / 10	100	6400	<b>11.500</b>
325100	350	24 / 40 / 3 / 10	100	5500	<b>14.900</b>
349233	400	28 / 40 / 3.6 / 10	100	4800	<b>21.500</b>
325176	450	32 / 40 / 3.6 / 10	100	4300	<b>22.900</b>

Disqe Diamanti

**DT 350 U**

**NEW !**

Klasi i Performacës EXTRA

Aplikimet:

 Agresiviteti        

 M.Konstruksioni 

 Jetëgjatësia        

 Beton 

Avantazhet: Për çdo përdorim, Performancë prerje e shkëlqyer, raport i balancuar performancë - Çmim, Segmente Turbo dhe për skajet. Ideale për prerjen e tjegullave.

Artikulli	Diameter në mm	Gjerësia në mm	V.max në m/s	Segment në mm	Max. RPM	Çmimi
336220	300	25.40	100	2.8	6400	<b>6.900</b>
336221	350	25.40	100	3	5500	<b>8.500</b>
347486	400	25.40	100	3.2	4800	<b>11.500</b>

Disqe Diamanti

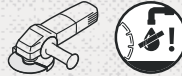
**DT 600 ACM**

**NEW !**

Klasi i Performacës EXTRA

Aplikimet:

 Agresiviteti        

 Asfalt 

 Jetëgjatësia        

 Pllaka Guri 

Avantazhet: Për çdo qëllim - Performancë prerje e shkëlqyer, raport i balancuar performancë  
Çmim - Ngjitja me laser, Segmente Turbo dhe për skajet. Ideale për punët e konstruksionit.

Kodi	Diameter në mm	Segmenti në mm	V.max në m/s	Max. RPM	Çmimi
355720	115 x 22,23	8 / 42 / 1,3 / 1,8	80	13300	<b>5.900</b>
355722	125 x 22,23	10 / 36 / 1,3 / 1,8	80	12200	<b>6.900</b>
355721	230 x 22,23	16 / 42 / 1,6 / 1,8	80	6600	<b>12.900</b>

Disqe Diamanti

**DT 900 ACR**

**NEW !**

Klasi i Performacës EXTRA

Aplikimet:

 Agresiviteti        

 Asfalt 

 Jetëgjatësia        

 Pllaka Guri 

Avantazhet: Për çdo qëllim - Performancë prerje e shkëlqyer, raport i balancuar performancë  
Çmim - Ngjitja me laser, Segmente Turbo dhe për skajet. Ideale për punët e konstruksionit.

Kodi	Diameter në mm	Gjerësia në mm	V.max në m/s	Segment në mm	Max. RPM	Çmimi
355723	115	22.23	80	2.8	13300	<b>6.900</b>
355724	125	22.23	80	2.8	12200	<b>7.500</b>
355725	230	22.23	80	3.1	6600	<b>14.500</b>

Disqe Diamanti

## DT 350 A



Klasi i Performacës EXTRA

Aplikimet:

Agresiviteti

Asfalt

Jetëgjatësia

Pllaka Guri

Avantazhet: Për çdo qëllim - Performancë prerje e shkëlqyer, raport i balancuar performancë - Çmim - Segmente Turbo dhe për skajet. Ideale për prerjen e tjegullave.

Artikulli	Diameter në mm	Gjerësia në mm	V.max në m/s	Segment në mm	Max. RPM	Çmimi
337730	350	25.4	100	3.2	5500	<b>9.900</b>
337734	450	25.4	100	3.7	4300	<b>14.900</b>
349236	400	20	100	3.6	4800	<b>12.900</b>

Disqe Diamanti

## DT 350 AB



Klasi i Performacës EXTRA

Aplikimet:

Agresiviteti

Asfalt

Jetëgjatësia

Beton

Avantazhet: Për çdo qëllim - Performancë prerje e shkëlqyer, raport i balancuar performancë - Çmim - Ngjitja me laser, Segmente Turbo dhe për skajet. Ideale për punët e konstruksionit.

Artikulli	Diameter në mm	Gjerësia në mm	V.max në m/s	Segment në mm	Max. RPM	Çmimi
340241	300	25.4	100	2.8	6400	<b>8.500</b>
340240	350	25.4	100	3.2	5500	<b>11.500</b>
349235	400	25.4	100	3.6	4800	<b>12.900</b>

Disqe Diamanti

## DT 305 A



Klasi i Performacës EXTRA

Aplikimet:

Agresiviteti

Asfalt

Jetëgjatësia

Pllaka Guri

Avantazhet: Për çdo qëllim - Performancë prerje e shkëlqyer, raport i balancuar performancë - Çmim - Ngjitja me laser, Segmente Turbo dhe për skajet. Ideale për punët e konstruksionit.

Artikulli	Diameter në mm	Gjerësia në mm	V.max në m/s	Segment në mm	Max. RPM	Çmimi
349237	400	25.4	100	3.6	4800	<b>11.500</b>



# Kronenflex® disqe prerës dhe axhustimi

1. Etika dhe fleta mbuluese  
Etiketa përmban të gjitha informacionet e rëndësishme për produktin, prodhuesin dhe trajtimin e duhur të diskut abraziv
2. Përzjerja  
Grimcat: Sot, të gjitha llojet e grimcave abrazive bëhen në mënyrë sintetike. Vetëm grimcat e prodhuara në mënyrë sintetike garantojnë cilësi të vazhdueshme të lartë për sa i përket konsumit dhe karakteristikave të prerjes së disqeve.  
Rezina dhe materialet mbushëse: Komponentët thelbësorë për disqet prerëse dhe disqet abrazive janë rezinat (në të lagur dhe në të thatë) dhe materialet mbushëse. Këta komponentë bëjnë të mundur që gjatë prodhimit të rregullohen vetitë e diskut si stabiliteti, shpejtësia e heqjes së materialeve, fortësia dhe rezistenca ndaj shpërthimit



3. Unaza metalike  
Ofron informacion mbi qëndrueshmërinë (datën e skadencës) të diskut
4. Rrjetë me fibra xhami  
Duke shtuar qëndrueshmëri si një mjet përforcues, rrjeta me fibra xhami përmirëson sigurinë e diskut. Rrjetat e fibrave të xhamit janë optimizuar për çdo lloj dhe qëllim të diskut në lidhje me sasinë dhe trashësinë e tyre. Sa më e madhe të jetë ngarkesa anësore potenciale e një diskut prerës (e cila, për shembull, do të jetë më e madhe gjatë axhustimit sesa gjatë prerjes së palëvizshme), aq më e madhe duhet të jetë sasia/stabiliteti i rrjetës së fibrave të qelqit në diskut prerës. Rrjeta e përdorur në disqet e holla prerëse (0,8 mm deri në 1,0 mm) është veçanërisht e hollë për të siguruar që pjesa e kokrrave gërryese midis shtresave të rrjetës të jetë sa më e lartë që të jetë e mundur pavarësisht nga trashësia e vogël e diskut. Disqet me letër zmerile përmbajnë një rrjetë me fibra xhami me të paktën 3 shtresa.

## Piktograma në faqet e produktit



Një rrjetë me fibër xhami



Dy rrjeta me fibër xhami



Pa hekur, sulfur dhe klorine



Paketuar në njësi prej 25 copë secila në kutinë Kronenflex® për performancë të lartë dhe mbrojtje të vazhdueshme nga lagështia

## Siguria dhe ruajtja

Qëndrueshmëria e disqeve prerëse dhe abrazive varet kryesisht nga përqendrimi i lagështisë së tyre.

Disqet prerës dhe abrazivë që ekspozohen ndaj niveleve të larta të lagështirës pas prodhimit nuk do të kenë më jetëgjatësinë e tyre origjinale.

Nëse ruhen siç duhet, disqet do të kenë një jetë shërbimi që mbetet pothuajse konstante për vite.

Disqet prerës dhe abrazivë kthehen në një rrezik nëse ekspozohen drejtpërdrejt ndaj ujit ose avullit.

Përdoruesit i kërkohet të përdorin produktin siç është menduar. E njëjta gjë vlen edhe për datën e skadencës. Prandaj është thelbësore që disqet prerës dhe abrazivë të mos përdoren kurrë pas datës së skadencës.



Gurë Prerës Inoksi

## A 60 EXTRA



**Kronenflex®**

Gurë prerës për gurë fleksibël



Klasi i Performacës EXTRA Aplikimet:

Agresiviteti	■ ■ ■ ■ ■ □ □	Universal për inox	●
Jetëgjatësia	■ ■ ■ ■ ■ □ □	Metale	○
Lidhja	■ ■ ■ ■ ■ □ □		

Avantazhet: Disk standart me raport të shkëlqyer çmim/performancë - Për përdorim universal në përpunimin e metaleve - rezultate të shkëlqyera në të gjitha llojet e gurë fleksibëlve.

Kodi	Diametri x Trashësia x Vrima në mm	Forma	V.max në m/s	Max. RPM	Sasia Paketimit/ Copë	Çmimi
262936	115 x 1.0 x 22.23		80	13300	25	<b>110</b>
262937	125 x 1.0 x 22.23		80	12200	25	<b>120</b>

Gurë Prerës Special Inoksi

## A 980 TZ



Klasi i Performacës SPECIAL Aplikimet:

Agresiviteti	■ ■ ■ ■ ■ □ □	Çelik	●
Jetëgjatësia	■ ■ ■ ■ ■ □ □	Inox	●
Lidhja	■ ■ ■ ■ ■ □ □	Alumin	●

Avantazhet: Pa hekur, sqfur dhe klorine - Jetëgjatësi maksimale për çdo aplikim - Prerje të sakta dhe të pastra. 25 copë në kutinë Kronenflex® për performancë të gjatë dhe mbrojtje nga lagështira.

Kodi	Diametër në mm	Gjerësia në mm	Vrima në mm	Forma	Max. RPM	Çmimi
322182	115	0.8	22.23		13300	<b>120</b>
322183	125	0.8	22.23		12200	<b>130</b>

Gurë Prerës SPECIAL

## A 946 TZ SPECIAL



Klasi i Performacës Special

Agresiviteti	■ ■ ■ ■ ■ □ □	Çelik	●
Jetëgjatësia	■ ■ ■ ■ ■ □ □	Inox	●
Lidhja	■ ■ ■ ■ ■ □ □	Alumin	○
		Gizë	○

Avantazhet: Pa hekur, sqfur dhe klorine - Jetëgjatësi maksimale për çdo aplikim - Për përdorim universal në metal - 25 copë në kutinë Kronenflex® për performancë të gjatë dhe mbrojtje nga lagështira.

Kodi	Diametri x Trashësia x Vrima në mm	V.max m/s	Forma	Max. RPM	Paketimi	Çmimi
339113	230 x 1,9 x 22,23	80		6600	25	<b>350</b>



Gurë Prerës Inoksi

## A 100 EXTRA



**Kronenflex®**

**NEW !**

Klasi i Performacës EXTRA Aplikimet:

Agresiviteti	■ ■ ■ ■ ■ □ □	Universal për inox	●
Jetëgjatësia	■ ■ ■ ■ ■ □ □	Metale	○
Lidhja	■ ■ ■ ■ ■ □ □		



Avantazhet: Disk standart me raport të shkëlqyer çmim/performancë - Për përdorim universal në përpunimin e metaleve - rezultate të shkëlqyera në të gjitha llojet e gurë fleksibëlve.

Kodi	Diametri x Trashësia x Vrima në mm	Forma	Sasia Paketimit/Copë	Çmimi
384801	115x1x22.23	—	50	<b>95</b>
384803	125x1x22.23	—	50	<b>110</b>

Gurë Prerës Inoksi

## A 100 EXTRA



**Kronenflex®**

**NEW !**

Klasi i Performacës EXTRA Aplikimet:

Agresiviteti	■ ■ ■ ■ ■ □ □	Universal për inox	●
Jetëgjatësia	■ ■ ■ ■ ■ □ □	Metale	○
Lidhja	■ ■ ■ ■ ■ □ □		



Avantazhet: Disk standart me raport të shkëlqyer çmim/performancë - Për përdorim universal në përpunimin e metaleve - rezultate të shkëlqyera në të gjitha llojet e gurë fleksibëlve.

Kodi	Diametri x Trashësia x Vrima në mm	Forma	Sasia Paketimit/Copë	Çmimi
384823	230x1.9x22.23	—	25	<b>285</b>

Gurë Prerës Special Inoksi

## A46TZ SPECIAL



Klasi i Performacës SPECIAL Aplikimet:

Agresiviteti	■ ■ ■ ■ ■ □ □	Universal për inox	●
Jetëgjatësia	■ ■ ■ ■ ■ □ □	Metale	○
Lidhja	■ ■ ■ ■ ■ □ □		



Avantazhet: Performancë e lartë prerje, edhe kur presioni i prerjes i ushtruar është në minimum

Kodi	Diametri x Trashësia x Vrima në mm	Forma	V.max në m/s	Max. RPM	Sasia Paketimit/Copë	Çmimi
224084	230 x 1.9 x 22.23	—	80	6600	25	<b>295</b>



Gurë Prerës Special Inoksi

## A36TZ SPECIAL



Klasi i Performacës SPECIAL Aplikimet:

Agresiviteti	■ ■ ■ ■ ■ □ □ □	Universal për inox	●
Jetëgjatësia	■ ■ ■ ■ ■ □ □ □	Metale	○
Lidhja	■ ■ ■ ■ ■ □ □ □		



Avantazhet: Formim minimal i ashklave gjatë prerjes, performancë e shkëlqyer në prerjen e kombinuar me jetëgjatësi të lartë

Kodi	Diametri x Trashësia x Vrime në mm	Forma	V.max në m/s	Max. RPM	Sasia Paketimit/ Copë	Çmimi
136552	230 x 2.0 x 22.23	—	80	6600	25	<b>350</b>

Gurë Pastrimi Supra Inoksi

## A624T SUPRA



**Kronenflex®** Gurë prerës dhe pastrimi për gurë fleksibël

**IRI**

Klasi i Performacës SPECIAL Aplikimet:

Agresiviteti	■ ■ ■ ■ ■ □ □ □	Çelik	●
Jetëgjatësia	■ ■ ■ ■ ■ □ □ □	Inox	●
Lidhja	■ ■ ■ ■ ■ □ □ □	Aliazh	●



Avantazhet: Performancë e lartë prerje, edhe për punimet më të vështira

Kodi	Diametri x Trashësia x Vrime mm	Forma	V.max në m/s	Max. RPM	Sasia Paketimit/ Copë	Çmimi
325215	115 x 6.0 x 22.23	—	80	13300	10	<b>390</b>
325216	125 x 6.0 x 22.23	—	80	12200	10	<b>450</b>
325217	180 x 6.0 x 22.23	—	80	8500	10	<b>650</b>
325218	230 x 6.0 x 22.23	—	80	6600	10	<b>990</b>



Gurë Prerës Metali

## A 24 EXTRA



**Kronenflex®** Gurë prerës dhe pastrimi për gurë fleksibël

Klasi i Performacës EXTRA

Aplikimet:

Agresiviteti

Universal për metale

Jetëgjatësia

Lidhja

Avantazhet: Disk standart me raport të shkëlqyer çmim/performancë - Për përdorim universal në përpunimin e metaleve - rezultate të shkëlqyera në të gjitha llojet e gurë fleksibëlve.

Kodi	Diametri x Trashësia x Vrima në mm	Forma	V.max në m/s	Max. RPM	Sasia Paketimit/ Copë	Çmimi
188461	115 x 2.5 x 22.23		80	13300	25	<b>120</b>
188463	125 x 2.5 x 22.23		80	12000	25	<b>130</b>
189002	230 x 3.0 x 22.23		80	6600	25	<b>320</b>

Gurë Pastrimi Metali

## A 24 EXTRA



Klasi i Performacës EXTRA

Aplikimet:

Agresiviteti

Universal për metale

Jetëgjatësia

Lidhja

Avantazhet: Disk standart me raport të shkëlqyer çmim/performancë - Për përdorim universal në përpunimin e metaleve - rezultate të shkëlqyera në të gjitha llojet e gurë fleksibëlve.

Kodi	Diametri x Trashësia x Vrima në mm	Forma	V.max në m/s	Max. RPM	Sasia Paketimit/ Copë	Çmimi
246682	115 x 6.0 x 22.23		80	13300	10	<b>290</b>
188466	125 x 6.0 x 22.23		80	12200	10	<b>350</b>
13403	150 x 6.0 x 22.23		80	10200	10	<b>550</b>
231862	180 x 6.0 x 22.23		80	8500	10	<b>590</b>
13447	230 x 6.0 x 22.23		80	6600	10	<b>790</b>

Gurë Prerës Betoni

## C 24 EXTRA



Klasi i Performacës EXTRA

Aplikimet:

Agresiviteti

Universal për beton dhe tullat

Jetëgjatësia

Lidhja

Avantazhet: Për çdo qëllim - Performancë prerje e shkëlqyer, raport i balancuar performancë - Çmim - Segmente Turbo dhe për skajet. Ideale për prerjen e tjeçullave.

Kodi	Diametri x Trashësia x Vrima në mm	Forma	V.max m/s	Max. RPM	Sasia Paketimit/ Copë	Çmimi
188462	115 x 2.5 x 22.23		80	15300	25	<b>125</b>
188464	125 x 2.5 x 22.23		80	13300	25	<b>135</b>
231886	180 x 3.0 x 22.23		80	8500	25	<b>265</b>
189003	230 x 3.0 x 22.23		80	8500	25	<b>390</b>



Gurë Prerës

## A330 EXTRA



**Kronenflex®**

Gurë prerës  
për tronkatrice



Klasi i Performacës EXTRA

Aplikimet:

Agresiviteti	■ ■ ■ ■ ■ ■ ■ ■
Jetëgjatësia	■ ■ ■ ■ ■ ■ ■ ■
Lidhja	■ ■ ■ ■ ■ ■ ■ ■

Universal për inox	●
Metale	○

Avantazhet: Performancë e lartë prerje, edhe kur presioni i prerjes i ushtruar është në minimum

Kodi	Diametri x Trashësia x Vrima në mm	Forma	V.max në m/s	Max. RPM	Sasia Paketimit/ Copë	Çmimi
353326	356 x 2.5 x 25.4	—	80	4400	10	<b>850</b>

Gurë Prerës

## A 630 N SUPRA



Klasi i Performacës SUPRA

Aplikimet:

Agresiviteti	■ ■ ■ ■ ■ ■ ■ ■
Jetëgjatësia	■ ■ ■ ■ ■ ■ ■ ■
Lidhja	■ ■ ■ ■ ■ ■ ■ ■

Universal për inox	●
Metale	○

Avantazhet: Performancë e lartë prerje, edhe kur presioni i prerjes i ushtruar është në minimum

Kodi	Diametri x Trashësia x Vrima në mm	Forma	V.max në m/s	Max. RPM	Sasia Paketimit/ Copë	Çmimi
353324	356 x 2.5 x 25.4	—	80	4400	10	<b>850</b>

Gurë Prerës

## A 930N SPECIAL



Klasi i Performacës SPECIAL

Aplikimet:

Agresiviteti	■ ■ ■ ■ ■ ■ ■ ■
Jetëgjatësia	■ ■ ■ ■ ■ ■ ■ ■
Lidhja	■ ■ ■ ■ ■ ■ ■ ■

Universal për çelik	●
Inox	○
Alumin	○
Derdhje Alumini	○

Avantazhet: Për përdorim të tronkatriceve të vogla - Gërvishje minimale - Mund të përdoret për tronkatrice metali < 3 Kw

Kodi	Diametri x Trashësia x Vrima në mm	Forma	V.max në m/s	Max. RPM	Sasia Paketimit/ Copë	Çmimi
322628	350 x 3.0 x 25.4	—	80	4400	10	<b>1.450</b>



# Disk abraziv me letër zmerile

## Struktura e produktit

Tre komponentët që përbëjnë diskun me letër zmerile janë përshtatur në mënyrë të përsosur në një përpjekje për të arritur performancën më të lartë të mundshme.

### 1. Fletët abrazive

Klingspor ka zhvilluar abrazivë të veçantë si plotësues i përsosur për disqet me letër zmerile. Këta abrazivë e bëjnë këtë disk të përshtatshëm në mënyrë ideale për t'u përdorur në zmerilimin me kënd me shpejtësi të lartë (80 m/s) dhe aplikimet përkatëse. Kështu, ato garantojnë të ofrojnë performancë gërryese superiore dhe jetë të gjatë shërbimi.

### 2. Pllaka mbështetëse

Për prodhimin e disqeve me letër zmerile, Klingspor përdor dy lloje të ndryshme pllakash mbështetëse. Përveç versionit më të përdorur në treg, një pllakë mbështetëse e bërë nga rrjetë me fibra xhami, Klingspor ofron gjithashtu një pllakë mbështetëse të bërë nga plastika e përforcuar me fibra.

### 3. Rezinë ngjitëse

Rezina ngjitëse shërben si lidhëse midis pllakës mbështetëse dhe fletëve gërryese. Siguron që asnjë fletë gërryese nuk do të shkëputet nga pllaka mbështetëse nëse mjeti përdoret siç është menduar. Ndër të tjera, ai siguron gjithashtu një nivel rezistence ndaj shkeputjes që shkon shumë përtej dispozitave të përcaktuara nga oSa dhe në standardin e sigurisë EN 13743..

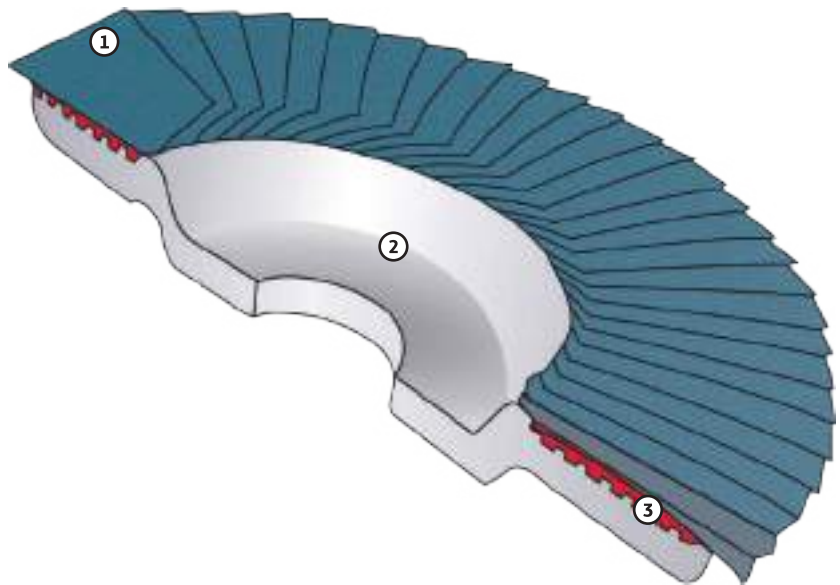

### 1. Veshje zirkon alumini

Grimca gërryese alumini zirkonike, veshje pambuku-poliester, performancë maksimale kur funksionon me makineri me performancë të lartë

### 2. Veshje zirkon alumini

Grimca gërryese alumini zirkonike, veshje pambuku, pastrim i mirë në pjesët këndore të të gjitha klasave të performancës

### 3. Zirkon alumini+ multigjites

Grimca gërryese alumini zirkoni vetë-mprehëse, veshje pambuku, e projektuar posaçërisht për punim në nox

### 4. Veshje oksid alumini

Grimca gërryese oksidi alumini afatgjata, veshje pambuku, për përdorim në metal dhe metale NF

### 5. Oksid alumini qeramik + multigjites

Grimca gërryese qeramike me performancë të lartë, mbështetëse e fortë poliestër, performancë maksimale për përpunimin e inoxit, zmerilim në sipërfaqet e inoksit

### 6. Oksid alumini qeramik

Grimca gërryese qeramike me performancë të lartë, mbështetëse e fortë poliestër, performancë maksimale për përpunimin e çelikut



1

2

3

4

5

6

7

8

9

10

Disk me letër zmerile

## SMT 314 SPECIAL



Klasi i Performacës EXTRA

Agresiviteti

Jetëgjatësia

Aplikimet:

Universal për metale	<input checked="" type="checkbox"/>
Çelik	<input checked="" type="checkbox"/>
Dru	<input checked="" type="checkbox"/>

Avantazhet: E përshtatshme për të gjitha metalet joferroze. Performancë e shkëlqyer pastrimi për të gjitha llojet e gurë fleksibëlve.

Kodi	Diametri x Trashësia x Vrima në mm	Forma	Grana	V.max në m/s	Max. RPM	Sasia Paketimit/ Copë	Çmimi
322809	115 x 22.23		40	80	12200	10	<b>280</b>
322811	115 x 22.23		60	80	13300	10	<b>280</b>
322812	115 x 22.23		80	80	12200	10	<b>280</b>
322815	125 x 22.23		40	80	12200	10	<b>290</b>
322817	125 x 22.23		60	80	12200	10	<b>290</b>
322818	125 x 22.23		80	80	12200	10	<b>290</b>

Disk me letër zmerile Inoksi

## SMT325 EXTRA



Klasi i Performacës EXTRA

Agresiviteti

Jetëgjatësia

Aplikimet:

Universal për metale	<input checked="" type="checkbox"/>
Inox	<input checked="" type="checkbox"/>

Avantazhet: Produkt universal për të punuar në qoshe dhe sipërfaqet e punës në çelik dhe inox. Normë e lartë pastrimi në gurë fleksibël e të gjithë klasave.

Kodi	Diametri x Trashësia x Vrima në mm	Forma	Grana	V.max në m/s	Max. RPM	Sasia Paketimit/ Copë	Çmimi
321653	115 x 22.23		40	80	13300	10	<b>350</b>
321655	115 x 22.23		60	80	13300	10	<b>350</b>
321657	115 x 22.23		80	80	13300	10	<b>350</b>
321654	125 x 22.23		40	80	12200	10	<b>360</b>
321656	125 x 22.23		60	80	12200	10	<b>360</b>
321658	125 x 22.23		80	80	12200	10	<b>360</b>

Disk me letër zmerile inoxi

## SMT 674 supra CEVOLUTION



Klasi i Performacës EXTRA

 Agresiviteti        

 Jetëgjatësia       

Aplikimet:

Universal për metale	<input checked="" type="checkbox"/>
Çelik	<input checked="" type="checkbox"/>
Dru	<input checked="" type="checkbox"/>



Avantazhet: E përshtatshme për të gjitha metalet joferroze. Performancë e shkëlqyer pastrimi për të gjitha llojet e gurë fleksibëlve.

Kodi	Diametri x Trashësia x Vrima në mm	Forma	Grana	V.max në m/s	Max. RPM	Sasia Paketimit/ Copë	Çmimi
369262	115x22.23		40	80	13300	10	<b>330</b>
369261	115x22.23		60	80	13300	10	<b>330</b>
369260	115x22.23		80	80	13300	10	<b>330</b>
369259	125x22.23		40	80	12200	10	<b>350</b>
369258	125x22.23		60	80	12200	10	<b>350</b>
369257	125x22.23		80	80	12200	10	<b>350</b>

Disk me letër zmerile Inoksi

## SMT975 Special CEVOLUTION



Klasi i Performacës EXTRA

 Agresiviteti        

 Jetëgjatësia        

Aplikimet:

Universal për metale	<input checked="" type="checkbox"/>
Inox	<input checked="" type="checkbox"/>



Avantazhet: Produkt universal për të punuar në qoshe dhe sipërfaqet e punës në çelik dhe inox. Normë e lartë pastrimi në gurë fleksibël e të gjithë klasave.

Kodi	Diametri x Trashësia x Vrima në mm	Forma	Grana	V.max në m/s	Max. RPM	Sasia Paketimit/ Copë	Çmimi
369295	115		40	80	13300	10	<b>480</b>
369296	115		60	80	13300	10	<b>480</b>
369297	115		80	80	13300	10	<b>480</b>
369304	125		80	80	12200	10	<b>490</b>
369301	125		40	80	12200	10	<b>490</b>
369303	125		60	80	12200	10	<b>490</b>



Letër zmerile për gurë fleksibël

Letër Zmerile / Kapje me vidë

## CS 561



### Karakteristika

Lënda Lidhëse	Rrëshira
Grimcat	Oksid Alumini
Mbulesa	Gjysëm e mbushur
Mbështetës	E-letër

### Aplikimet:

Universal për metale	●
Çelik	●
Xham	○
Gurë	○

Avantazhet: Produktivitet i lartë për punë të vështira. Reduktim i mbushjeve me pluhur falë teknologjisë ACT dhe vetive antistatike.

Kodi	Diametri në mm	Grana	Vrima në mm	Max. RPM	Nr. në paketim	Çmimi
10980	115	36	○ 22	13300	25	<b>85</b>
10981	115	40	○ 22	13300	25	<b>85</b>
10983	115	60	○ 22	13300	25	<b>85</b>
10984	115	80	○ 22	13300	25	<b>85</b>
10985	115	100	○ 22	13300	25	<b>85</b>
10986	115	120	○ 22	13300	25	<b>85</b>
10987	115	150	○ 22	13300	25	<b>85</b>
10988	115	180	○ 22	13300	25	<b>85</b>
11060	180	36	○ 22	8500	25	<b>190</b>
11061	180	40	○ 22	8500	25	<b>190</b>
11063	180	60	○ 22	8500	25	<b>190</b>
11064	180	80	○ 22	8500	25	<b>190</b>
11065	180	100	○ 22	8500	25	<b>190</b>
11066	180	120	○ 22	8500	25	<b>190</b>
11067	180	150	○ 22	8500	25	<b>190</b>
11068	180	180	○ 22	8500	25	<b>190</b>

Letër zmerile me ngjitje

## PS 22 K



### Karakteristika

Lënda Lidhëse	Rrëshira
Grimcat	Oksid Alumini
Mbulesa	Gjysëm e mbushur
Mbështetës	E-letër

### Aplikimet:

Dru	●	Plastik	○
Metal	●		
Çelik	○		
Lyerje/Llak/Mbushje	○		

Letër zmerile rrethore  
Me ngjitje

Avantazhet: Letër zmerile universale për punë në dru dhe metal - I disponueshëm në dimensione dhe madhësi të ndryshme

Kodi	Diametri në mm	Ashpërsia	Lloji i vrimave	Nr. në paketim	Çmimi
82938	115	40	GLS 4	50	<b>39</b>
82940	115	60	GLS 4	50	<b>39</b>
82941	115	80	GLS 4	50	<b>39</b>
82942	115	100	GLS 4	50	<b>39</b>
82944	115	120	GLS 4	50	<b>39</b>
82946	115	180	GLS 4	50	<b>39</b>
87424	115	240	GLS 4	50	<b>39</b>

Letër zmerile me ngjitje

## PS 22 K



### Karakteristika

Lënda Lidhëse Rrëshira	
Grimcat	Oksid Alumini
Mbulesa	Gjysëm e mbushur
Mbështetës	E-letër

### Aplikimet:

Dru	<input checked="" type="radio"/>	Plastik	<input type="radio"/>
Metal	<input checked="" type="radio"/>		
Çelik	<input type="radio"/>		
Lyerje/Llak/Mbushje	<input type="radio"/>		

Avantazhet: Letër zmerile universale për punë në dru dhe metal - I disponueshëm në dimensione dhe madhësi të ndryshme

16 24 30 36 40 50 60 80 100 120 150 180 220 240 280 320 360 400 500 600 800 1000 1200 1500 2000

Kodi	Diametri në mm	Ashpërsia	Lloji i vrimave	Nr. në paketim	Çmimi
6754	115	24	0	50	<b>39</b>
2785	115	40	0	50	<b>39</b>
2786	115	60	0	50	<b>39</b>
6756	115	80	0	50	<b>39</b>
2787	115	100	0	50	<b>39</b>
6757	115	120	0	50	<b>39</b>
80046	115	150	0	50	<b>39</b>
2788	115	180	0	50	<b>39</b>
88330	115	220	0	50	<b>39</b>
88333	115	240	0	50	<b>39</b>
95561	115	320	0	50	<b>39</b>
111470	115	400	0	50	<b>39</b>
89486	125	40	GLS 5	50	<b>49</b>
89488	125	60	GLS 5	50	<b>49</b>
89489	125	80	GLS 5	50	<b>49</b>
89491	125	100	GLS 5	50	<b>49</b>
89493	125	120	GLS 5	50	<b>49</b>
89494	125	150	GLS 5	50	<b>49</b>
89495	125	180	GLS 5	50	<b>49</b>
90758	125	220	GLS 5	50	<b>49</b>
92753	125	240	GLS 5	50	<b>49</b>
89496	125	320	GLS 5	50	<b>49</b>
104778	125	400	GLS 5	50	<b>49</b>
96486	150	40	GLS 6	50	<b>75</b>
96487	150	60	GLS 6	50	<b>75</b>
96488	150	80	GLS 6	50	<b>75</b>
98162	150	100	GLS 6	50	<b>75</b>
96489	150	120	GLS 6	50	<b>75</b>
86637	150	150	GLS 3	50	<b>75</b>
87528	150	180	GLS 3	50	<b>75</b>
100157	150	220	GLS 3	50	<b>75</b>
97778	150	240	GLS 3	50	<b>75</b>
97779	150	320	GLS 3	50	<b>75</b>
128356	150	400	GLS 3	50	<b>75</b>

Letër zmerile me ngjitje

## PS 33 BK PS 33 CK

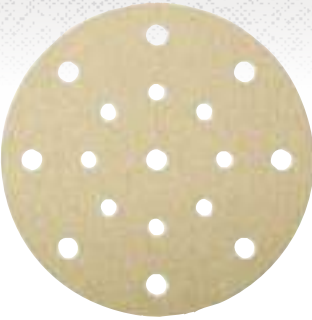

### Karakterisitika

Lënda Lidhëse Rrëshira	
Grimcat	Oksid Alumini
Mbulesa	Gjysëm e mbushur
Mbështetësi	C-letër

### Aplikimet:

Lyerje/Llak/Mbushje	●
Dru	●
Plastik	○

Avantazhet: Pastrim i shkëlqyer, për aplikime të ndryshme.

16 24 30 36 40 50 60 80 100 120 150 180 220 240 280 320 360 400 500 600 800 1000 1200 1500 2000

Kodi	Diametri në mm	Ashpërsia	Lloji i vrimave	Nr. në paketim	Çmimi
147701	115	40	0	100	85
147144	115	80	0	100	85
146955	115	120	0	100	85
154113	125	40	0	100	85
147604	125	60	0	100	85
149055	125	80	0	100	85
150431	125	100	0	100	85
147922	150	40	0	100	85
147107	150	60	0	100	85
146739	150	80	0	100	85
147106	150	100	0	100	85
146740	150	120	0	100	85
148375	150	150	0	100	85
146958	150	180	0	100	85
149916	150	220	0	100	85
146959	150	240	0	100	85
146716	150	320	0	100	85
147108	150	400	0	100	85
147647	150	40	GLS3	100	79
147124	150	60	GLS3	100	79
146946	150	80	GLS3	100	79
143694	150	100	GLS3	100	79
146947	150	120	GLS3	100	79
149151	150	150	GLS3	100	79
146948	150	180	GLS3	100	79
149255	150	220	GLS3	100	79
146907	150	240	GLS3	100	79
147126	150	320	GLS3	100	79
147125	150	400	GLS3	100	79
314427	225	40	0	50	125
223162	225	40	0	50	180
312448	225	60	0	50	125
312449	225	80	0	50	125
312450	225	100	0	50	125
312451	225	120	0	50	125
312452	225	150	0	50	125
314428	225	180	0	50	125
233622	225	220	0	50	125
292193	225	240	0	50	125



Leter me ngjitje per zmeriluese muresh

## AN 400

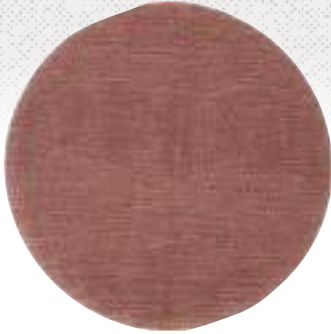

### Karakterisitika

Lënda Lidhëse	Rrëshira
Grimcat	Me kokerriza
Mbulesa	Rrjete poliester

### Aplikimet:

Boje	●
Suva	●
Dru	●
Gips	●
Materiale te perbera	●

Kodi	Diametri në mm	Ashpersia	Paketimi	Çmimi
337886	150	80	50	<b>210</b>
337871	225	80	50	<b>450</b>
337875	225	100	50	<b>450</b>
337873	225	120	50	<b>450</b>
337874	225	150	50	<b>450</b>
337872	225	180	50	<b>450</b>
337878	225	240	50	<b>450</b>

Gominë me kapje për letër zmerile për gurë fleksibël

## ST 358



Avantazhet: Gomina mesatarisht e fortë lejon përshtatjen optimale me materialin punues. Për përdorim universal, veçanërisht për zmerilim dhe luçidim sipërfaqesh. Rezistente ndaj temperaturave.

Kodi	Diametri në mm	Kapja	E përshtatshme për	Max. RPM	Max. RPM	Çmimi
14838	115	M14	Diametër 115x22	80	13300	<b>850</b>
14835	125	M14	Diametër 125x22	80	12200	<b>890</b>
14836	150	M14	Diametër 150x22	80	10200	<b>990</b>
14840	180	M14	Diametër 180x22	80	8500	<b>2.890</b>

Gominë me ngjitje

## HST 359



Avantazhet: Kapje shumë e mirë për të gjitha letrat zmerile me ngjitje, falë kapjes së imët dhe rezistente ndaj temperaturave.

Kodi	Diametri në mm	Kapja	Çmimi
70433	115	M14	<b>990</b>
70434	125	M14	<b>1.290</b>
70436	150	M14	<b>1.490</b>

Letër uji e zezë

## PS 8 A



### Karakterisitika

Lënda Lidhëse	Rrëshira
Grimcat	Silikon Karboni
Mbulesa	E mbushur
Mbështetësi	A-letër

### Aplikimet:

Lyerje/Llak/Mbushje	●
Plastik	●
Xham/Gurë	○
Metale	○

Avantazhet: Ideale për sipërfaqet e forta dhe të ashpra. Letër shumë fleksibël, ofron një përshtatje të përkryer. Mund të përdoret për zmerilim të lagësht dhe të thatë.

16 24 30 36 40 60 80 100 120 150 180 220 240 260 280 320 360 400 500 600 800 1000 1200 1500

Kodi	Gjatësi x Gjerësi në mm	Ashpërsia	Nr. në paketim	Çmimi
269275	230X280	220	50	<b>69</b>
269285	230X280	280	50	<b>69</b>
269289	230X280	320	50	<b>69</b>
269294	230X280	360	50	<b>69</b>
269299	230X280	400	50	<b>69</b>
269306	230X280	500	50	<b>69</b>
269314	230X280	600	50	<b>69</b>
269323	230X280	800	50	<b>69</b>
269328	230X280	1000	50	<b>69</b>
269334	230X280	1200	50	<b>69</b>
269344	230X280	2000	50	<b>69</b>
269352	230X280	2500	50	<b>69</b>

Letër uji e zezë për metal

## PS 11 A



### Karakterisitika

Lënda Lidhëse	Rrëshira
Grimcat	Silikon Karboni
Mbulesa	E mbushur
Mbështetësi	C-letër

### Aplikimet:

Lyerje/Llak/Mbushje	●
Plastik	●
Xham/Gurë	○
Metale	○

Avantazhet: Produkt special për riparim dhe lyerje. Për sipërfaqe të forta dhe të ashpra. Përshtatje dhe stabilitet i lartë. Për zmerilim në materiale të lagështa dhe të thata.

16 24 30 36 40 60 80 100 120 150 180 220 240 260 280 320 360 400 500 600 800 1000 1200 1500

Kodi	Gjatësi x Gjerësi në mm	Ashpërsia	Nr. në paketim	Çmimi
6616	230X280	1200	50	<b>99</b>

Letër gri format për dru

## PC 33 C



Karakterisitika		Aplikimet:	
Lënda Lidhëse	Rrëshira	Lyerje/Llak/Mbushje	●
Grimcat	Oksid Alumini	Dru	●
Mbulesa	Gjysëm mbushur	Plastik	○
Mbështetësi	B/C-letër		

Avantazhet: Koefficient i lartë pastrimi. Për aplikime të ndryshme.

16 24 30 36 40 60 80 100 120 150 180 220 240 260 280 320 360 400 500 600 800 1000 1200 1500

Kodi	Gjatësi x Gjerësi në mm	Ashpërsia	Nr. në paketim	Çmimi
147850	230X280	60	50	<b>50</b>
147851	230X280	80	50	<b>50</b>
149719	230X280	100	50	<b>50</b>
147852	230X280	120	50	<b>50</b>
149528	230X280	150	50	<b>50</b>
147853	230X280	180	50	<b>50</b>
149529	230X280	220	50	<b>50</b>
147854	230X280	240	50	<b>50</b>
149793	230X280	280	50	<b>50</b>
149530	230X280	320	50	<b>50</b>
148971	230X280	400	50	<b>50</b>
170667	230X280	500	50	<b>50</b>
170668	230X280	600	50	<b>50</b>

Leter per Flex

## FS 964 ACT

**NEW !**



Karakterisitika		Aplikimet:	
Lënda Lidhëse	Rrëshira	Lyerje/Llak/Mbushje	●
Grimcat	Oksid Alumini	Dru	●
Mbulesa	Gjysëm e mbushur	Plastik	○
Mbështetësi	C-letër		

Avantazhet: Pastrim i shkëlqyer, për aplikime të ndryshme.

16 24 30 36 40 50 60 80 100 120 150 180 220 240 280 320 360 400 500 600 800 1000 1200 1500 2000

Kodi	Diametri në mm	Ashpërsia	Max. RPM	V.max në m/s	Çmimi
330486	125	40	12200	80	<b>290</b>



Letër zmerile tanku

## LS 309 XH



### Karakterisitika

Lenda	Rrëshira
Grimcat	Oksid Alumini
Mbulesa	E mbushur
Mbështetësi	X-Pambuk

### Aplikimet:

Dru	●
Metale	●
Metale jo ferroze	●
Lyerje/Llak/Mbushje	○



Avantazhet: Special për përdorim të gjithanshëm në dru, metale, bojë, llak. Përdoret në të gjitha makineritë standarte me rrip.

16 24 30 36 40 60 80 100 120 150 180 220 240 260 280 320 360 400 500 600 800 1000 1200 1500

Kodi	Gjatësi x Gjerësi në mm	Ashpërsia	Bashkues Rripi	Nr. në paketim	Çmimi
7018	75x533	40	F5	3	<b>690</b>
7077	75x533	180	F5	3	<b>690</b>
7036	100x560	40	F5	3	<b>790</b>
7037	100x560	60	F5	3	<b>790</b>
7038	100x560	80	F5	3	<b>790</b>
7039	100x560	100	F5	3	<b>790</b>
7040	100x560	120	F5	3	<b>790</b>



Bllok zmerilimi me kend

## SK 700 A

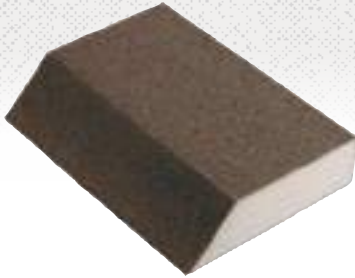

### Karakterisitika

Grimcat	Oksid Alumini
Mbulesa	E mbushur

### Aplikimet:

Lyerje/Llak/Mbushje	●
Dru	●
Plastik	○
Metale	○

Bllok Zmerilimi

## SK 500



Avantazhet: I përshtatshëm për tu përdorur në të gjitha anët. Kënd i ngushtë 45° lehtëson punën sidomos në sipërfaqet e ngushta. Punim dhe shpërndarje e forcës ekselente falë mbushjes fleksible të brëndshme. I qëndrueshëm, lahet lehtë dhe i ripërdorshëm.

16 24 30 36 40 60 80 100 120 150 180 220 240 260 280 320 360 400 500 600 800 1000 1200 1500

Kodi	Diametri në mm	Ashpërsia	Nr. në paketim	Çmimi
337847	125x89x25	80	100	<b>320</b>

Kodi	Diametri në mm	Ashpërsia	Nr. në paketim	Çmimi
125279	100x70x25	60	100	<b>125</b>
225165	100x70x25	80	100	<b>125</b>
125280	100x70x25	100	100	<b>125</b>
225166	100x70x25	120	100	<b>125</b>
225167	100x70x25	180	100	<b>125</b>

Beze Zmerile me top 50m

## KL 385 JF



### Karakterisitika

Lënda Lidhëse	Rrëshira
Grimcat	Oksid Alumini
Mbulesa	Oksid
Mbështetësi	Beze

### Aplikimet:

Metal	●
Metal jo ferrozë	●
Inox	○
Plastik	○
Dru	○

16 24 30 36 40 60 80 100 120 150 180 220 240 260 280 320 360 400 500 600 800 1000 1200 1500

Kodi	Diametri në mm	Ashpërsia	Nr. në paketim	Çmimi
224650	115 x 50000	40	1	<b>9.900</b>
228151	115 x 50000	60	1	<b>9.900</b>
228363	115 x 50000	80	1	<b>9.900</b>
228364	115 x 50000	100	1	<b>9.900</b>
228365	115 x 50000	120	1	<b>9.900</b>
228370	115 x 50000	150	1	<b>9.900</b>
228366	115 x 50000	180	1	<b>9.900</b>
228367	115 x 50000	240	1	<b>9.900</b>
228368	115 x 50000	320	1	<b>9.900</b>
228369	115 x 50000	400	1	<b>9.900</b>

## Gure prerës inoxi i hollë



Versioni	Makineri	Materiali
★ ★ ★ Profesional		

### Karakteristikat e produktit:

Gure prerës inoxi i hollë me formulë shumë të hollë për prerje të shpejtë dhe pa gërvishje të inoksit materiale çeliku. Prerje e shpejtë, e qëndrueshme dhe e ftohtë e kombinuar me jetëgjatësinë ideale të produktit. Formule e përmirësuar Formula lidhëse dhe zgjedhja më e mirë e kokrrave gërryese për jetëgjatësi të ruajtjes të qëndrueshme të performancës.

Kodi	Dimensionet	Specifikimet	Tipi	Paketimi	Cmimi
272581	115 x 1,0 x 22,23	INOX A 60 T BF	41	25	<b>69</b>
272589	125 x 1,0 x 22,23	INOX A 60 T BF	41	25	<b>75</b>
590123	230 x 1,9 x 22,23	INOX A 60 T BF	41	30	<b>180</b>

## Gure pastrimi për inox



Versioni	Makineri	Materiali
★ ★ ★ Profesional		

### Karakteristikat e produktit:

Gure pastrimi me formulë speciale për bluarje të ashpër të materialeve prej çeliku të pandryshkshëm me lidhje të ulët dhe të lartë. Balancë e shkëlqyer e lehtësisë së funksionimit dhe jetëgjatësisë së produktit. Ndërtim i fortë tekstil me fije qelqi për qëndrueshmëri dhe siguri operative.

Kodi	Dimensionet	Specifikimet	Tipi	Paketimi	Cmimi
272106	115 x 6,0 x 22,23	INOX A 24 R BF	27	25	<b>180</b>
272108	125 x 6,0 x 22,23	INOX A 24 R BF	27	25	<b>220</b>
272119	230 x 8,0 x 22,23	INOX A 24 R BF	27	10	<b>550</b>

## Gure prerës metal i hollë



Versioni	Makineri	Materiali
★ ★ ★ Profesional		

### Karakteristikat e produktit:

Gure prerës metal i hollë shumë e hollë për qëllime të përgjithshme për prerje të rënda të metaleve me ngjyra (çeliku, saldime hekuri, etj.) Balancë e shkëlqyer e lehtësisë së funksionimit dhe jetëgjatësisë së produktit.

Kodi	Dimensionet	Specifikimet	Tipi	Paketimi	Cmimi
590226	115 x 1,0 x 22,23	A 60 R BF	41	25	<b>65</b>
590241	125 x 1,0 x 22,23	A 60 R BF	41	25	<b>69</b>





## Gure preres metali

Versioni	Makineri	Materiali
★ ★ ★ Profesional		

### Karakteristikat e produktit:

Gure prerës për qëllime të përgjithshme për prerje të rënda të metaleve si (çeliku, hekuri, saldime, etj.) Balancë e shkëlqyer e lehtësisë së funksionimit dhe jetëgjatësisë së produktit.

Kodi	Dimensionet	Specifikimet	Tipi	Paketimi	Cmimi
272006	115 x 3,0 x 22,23	A 30 R BF	41	50	<b>69</b>
272011	125 x 3,0 x 22,23	A 30 R BF	41	50	<b>75</b>
272027	230 x 3,0 x 22,23	A 30 R BF	41	25	<b>220</b>



## Gure pastrimi per metal

Versioni	Makineri	Materiali
★ ★ ★ Profesional		

### Karakteristikat e produktit:

Gure pastrimi për qëllime të përgjithshme për bluarjen e ashpër të metaleve si (saldime çeliku, hekuri, etj.) Balancë e shkëlqyer e lehtësisë së funksionimit dhe jetëgjatësisë së produktit. Ndërtimi Tekstil me fije qelqi të fortë për qëndrueshmëri dhe siguri operative.

Kodi	Dimensionet	Specifikimet	Tipi	Paketimi	Cmimi
272036	115 x 6,0 x 22,23	A 24 R BF	27	25	<b>170</b>
272038	125 x 6,0 x 22,23	A 24 R BF	27	25	<b>190</b>
272047	230 x 6,0 x 22,23	A 24 R BF	27	10	<b>390</b>



## Gure preres betoni

Versioni	Makineri	Materiali
★ ★ ★ Profesional		

### Karakteristikat e produktit:

Gure preres betoni me formulë speciale për prerje të rëndë të mermerit, natyral (granit, etj.) ose materiale prej guri sintetik (çimento etj.). Kokrra karabit silikoni me performancë të lartë për jetë të gjatë dhe prerje agresive. Lehtësia e funksionimit dhe prerja e ftohtë e kombinuar me jetëgjatësinë ideale të produktit.

Kodi	Dimensionet	Specifikimet	Tipi	Paketimi	Cmimi
272146	115 x 3,0 x 22,23	C 30 R BF	41	50	<b>120</b>
272167	230 x 3,0 x 22,23	C 30 R BF	41	25	<b>290</b>



## Gure prerës metal

Versioni

★ ★ ★  
Profesional

Makineri



Materiali



### Karakteristikat e produktit:

Gure prerës metal për qëllime të veçanta për funksionimin e prerjes së çelikut dhe metaleve me ngjyra në vegla të palëvizshme. Sistem lidhës me cilësi të lartë për siguri, prerje të qëndrueshme dhe jetë të gjatë.

Kodi	Dimensionet	Specifikimet	Tipi	Paketimi	Cmimi
272053	300 x 3,0 x 25,4	A 30 R BF	41	10	<b>390</b>

## Gure zmeril bango

Materiali



### Karakteristikat e produktit:

Gure zmeril bango për heqjen, mprehjen, formësimin e metaleve me ngjyre dhe vegla çeliku. Grilat e imta janë të përshtatshme për operacionet e bluarjes së të ngurtësuar dhe çelique të paforcuar, (stërviqe spirale, kaçavida, dalta, dalta tornuese, çarëse, veglat, etj.) Gërshët shumë të trashë janë të përshtatshëm për heqjen e gërvishitjeve.

Kodi	Dimensionet	Grana	Tipi	Paketimi	Cmimi
272375	150 x 20 x 20	P60	1	10	<b>1.250</b>
272379	200 x 20 x 20	P60	1	10	<b>1.990</b>

## Kupe zmerilimi betoni per metal

Materiali



### Karakteristikat e produktit:

Kupe zmerilimi betoni per metal për aplikime çeliku me aliazh të lartë, duke përfshirë mprehjen e veglave. Jetegjatesi.

Kodi	Dimensionet	Specifikimet	Tipi	Paketimi	Cmimi
272462	E-50	EKR 46 K 6 V	11	10	<b>750</b>
272463	E-75	EKR 46 K 6 V	11	10	<b>750</b>
272475	E-125	EKR 46 K 6 V	11	5	<b>990</b>



## Disk me leter zmerile zirkoni

Versioni



Profesional

Makineri



Materiali



### Karakteristikat e produktit:

Disk me leter zmerile zirkoni me cilësi të lartë, prej alumini zirconia për çelik me aliazh të lartë dhe aplikime të rënda të gjitha metalet. Pëlhurë gërryese premium dhe formulë speciale lidhëse me përmbajtje të pasur zirkonium mundëson heqjen e shpejtë të stokut dhe lehtësinë e funksionimit së bashku me jetëgjatësinë e produktit.

Kodi	Dimensionet	Grana	Tipi	Paketimi	Cmimi
590032	125 x 22,23	40	Konike	10	<b>210</b>
590033	125 x 22,23	60	Konike	10	<b>210</b>
590034	125 x 22,23	80	Konike	10	<b>210</b>
590036	180 x 22,23	60	Konike	10	<b>490</b>
590038	115 x 22,23	40	E sheshte	10	<b>199</b>
590039	115 x 22,23	60	E sheshte	10	<b>199</b>
590040	115 x 22,23	80	E sheshte	10	<b>199</b>



## Disk me leter zmerile Oxide

Versioni



Profesional

Makineri



Materiali



### Karakteristikat e produktit:

Disk me leter zmerile Oxide me cilësi të lartë, oksid alumini për çelik me aliazh të ulët ose të gjitha aplikimet e drurit. Superiore Pëlhura gërryese dhe formula e fortë lidhëse mundëson heqjen e shpejtë të stokut së bashku me idealin jeta e produktit.

Kodi	Dimensionet	Grana	Tipi	Paketimi	Cmimi
590047	115 x 22,23	40	Konike	10	<b>180</b>
590048	115 x 22,23	60	Konike	10	<b>180</b>
590049	115 x 22,23	80	Konike	1	<b>180</b>
590050	125 x 22,23	40	Konike	0	<b>190</b>
590051	125 x 22,23	60	Konike	10	<b>190</b>
590052	125 x 22,23	80	Konike	10	<b>190</b>



### Leter per Flex Oxide



Kodi	Permasat	Grana	Paketimi	Cmimi
613121	115 mm	40	100	<b>39</b>
613122	115 mm	80	100	<b>39</b>
613123	115 mm	120	100	<b>39</b>

### Leter per Flex Oxide



Kodi	Permasat	Grana	Paketimi	Cmimi
613124	115 mm	40	100	<b>50</b>
613125	115 mm	80	100	<b>50</b>
613126	115 mm	120	100	<b>50</b>

### Leter me ngjitje pa vrime



Kodi	Permasat	Grana	Paketimi	Cmimi
813121	115 mm	40	100	<b>39</b>
813122	115 mm	80	100	<b>39</b>
813123	115 mm	120	100	<b>39</b>
813124	115 mm	400	100	<b>39</b>

### Leter me ngjitje me vrime



Kodi	Permasat	Grana	Paketimi	Cmimi
913121	225 mm	40	50	<b>120</b>
913122	225 mm	80	100	<b>120</b>
913123	225 mm	120	100	<b>120</b>

### Kuti sfungjeri zmerilimi



Kodi	Permasat	Grana	Paketimi	Cmimi
354164	115 mm	P120	1	<b>3.900</b>
354165	115 mm	P400	1	<b>3.900</b>

### Leter uji e zeze

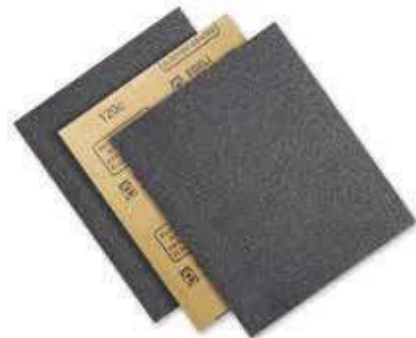

Kodi	Permasa	Grana	Paketimi	Cmimi
443464	230x280	P220	100	<b>55</b>
443465	230x280	P500	100	<b>55</b>
443466	230x280	P600	100	<b>55</b>
443467	230x280	P1200	100	<b>55</b>
443468	230x280	P2000	100	<b>55</b>



### Disk me qeleshe

Kodi	Dimensionet	Kapja	Paketimi	Cmimi
714131	115x20 mm	M14	5	<b>750</b>

### DISK PER FREZE BISKOTASH



Kodi	Dimensioni	Çmimi
49758941	100x22x3,8 mm 6Z	<b>990</b>

### TAMPON ZMERILIMI + SFUNGJER M 14



Kodi	Dimensioni	Çmimi
BHT2015	150 mm	<b>490</b>
BHT2016	180 mm	<b>650</b>

### GOMINE ME NGJITJE PER GURE FLEKSIBEL



Kodi	Dimensioni	Çmimi
BHT2027	115 mm	<b>290</b>
BHT2028	125 mm	<b>350</b>
BHT2029	150 mm	<b>450</b>
BHT2030	180 mm	<b>490</b>

### DISK ME LETER ZMERILE 115 MM



Kodi	Dimensioni	Çmimi
07974	P40	<b>150</b>
07975	P60	<b>150</b>
07976	P80	<b>150</b>
07977	P100	<b>150</b>
07978	P120	<b>150</b>

### GUR ZMERILUESE BANGO K60



Kodi	Disku	Çmimi
49507765	200x32 mm	<b>1.690</b>

### SFUNGJER ZMERILIMI PER POLIATRICE / ZMERILUESE



Kodi	Dimensioni	Çmimi
BHT2017	150 mm	<b>330</b>
BHT2018	180 mm	<b>330</b>

### TAMPON LSHI PER POLIATRICE



Kodi	Dimensioni	Çmimi
BHT2021	125 mm	<b>850</b>
BHT2022	150 mm	<b>1.190</b>
BHT2023	180 mm	<b>1.300</b>

### DISK ME LETER ZMERILE 125 MM



Kodi	Dimensioni	Çmimi
07984	P40	<b>170</b>
07985	P60	<b>170</b>
07986	P80	<b>170</b>
07987	P100	<b>170</b>
07988	P120	<b>170</b>

### SET ME 5 LETRA SHIRIT PER ZMERILUESE BANGO



Kodi	Disku	Çmimi
49910805	50x686 mm	<b>450</b>

### SFUNGJER ZMERILIMI I VALEZUAR



Kodi	Dimensioni	Çmimi
BHT2019	150 mm	<b>299</b>
BHT2020	180 mm	<b>330</b>

### TAMPON LSHI PER LUCIDIM



Kodi	Dimensioni	Çmimi
BHT2024	125 mm	<b>550</b>
BHT2025	150 mm	<b>690</b>
BHT2026	180 mm	<b>750</b>

### FURCE KUPE TELI BRONZI 75 MM M14



Kodi	Dimensioni	Çmimi
06970	75 mm	<b>250</b>

### SET ME 17 AKSESORE PER MINI ZMERILUESE



Kodi	Dimensioni	Çmimi
25411	Aksi 3.2 mm	<b>750</b>

## Ajerngrohese



79320

- Fuqia: 2000 W



2.390

## Furce teli me fije bronzi



06965

- Materiali: Broi
- Dorezë plastike



120

## Furce teli e ashper M14



06975

- Diametri: 80 mm
- Max .8500 U/min



550

## Gure zmeril bango



08865

- Permasa: 150 x 12.7 x 17mm



220

## Ajerngrohese me aksesore



79325

- Fuqia: 2000 W



2.990

## Kallama ngjites



73271

- Permasa: 11.2x150mm
- Paketimi: 12 copë



390

## Gure zmeril bango



08861

- Permasa: 125 x 12.7 x 17mm



150

## Gure zmeril bango



08875

- Permasa: 200 x 31.7 x 12mm



690



### SET ME 4 AKSESORE PER MAKINERI MULTIFUNKSIONALE

**IRI**

490

WMA9401



Sasia

4 Cope

### SET ME 4 TAMPONE PASTRIMI

**IRI**

450

WND4406



Permasa

3"/89mm

### SET ME 3 FURCA PASTRIMI METALI 9" ME DOREZE PLASTIKE

**IRI**

250

WBH3609



Permasa

9"

### FURCE TELI ME DOREZE PLASTIKE

**ERE**

100

WBH1101



Permasa

250mm 10"

### GUR MPREHES

**IRI**

69

WYS2502



Permasa

230x35x15mm, Gr. 120

### GUR MPREHES ME 2 ANE

**IRI**

100

WYS1502



Permasa

200x50x25mm, Gr. 120/240

### SET ME 2 BLOQE ZMERILIMI

**IRI**

2PCS/SET

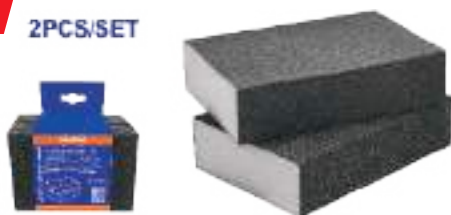

Kodi	Permasa	Çmimi
WUK2501	100x70x25mm, Gr.80	100
WUK2502	100x70x25mm, Gr.120	100

### SET ME 2 BLOQE ZMERILIMI

**IRI**

2PCS/SET

100

WUK2503

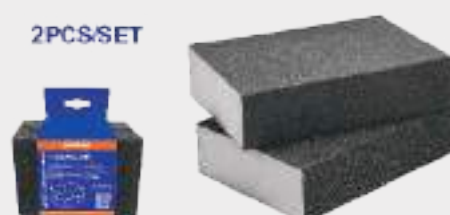

Permasa

100x70x25mm, Gr.180

### SET ME 2 DISQE DIAMANTI PER BETON

290

DMD0111523



Diametri 115 mm x 22.2 mm  
Spesori 7 mm

### SET ME 3 DISQE DIAMANTI PER BETON

2.350

DMD0123023



Permasa 230 mm x 22.2 X 7 mm  
9"

### DISK DIAMANTI SUPER I HOLLE

750

DMD031151HT



Permasa 115 x 22.2 mm  
Spesori 0.8 mm

### DISK DIAMANTI SUPER I HOLLE



Kodi	Disku	Çmimi
DMD081151HT	115 x 0.8 x 1.4 x 22.2 mm	<b>550</b>
DMD081251HT	125 x 0.8 x 1.4 x 22.2 mm	<b>790</b>

### DISK DIAMANTI SUPER I HOLLE

390

DMD031152HT



Permasa 115 x 22.2 mm  
Spesori x 1.0 mm

### DISK DIAMANTI SUPER I HOLLE

490

DMD031252HT



Permasa 125 x 22.2 mm  
Spesori 1.0 mm

### DISK DIAMANTI SUPER I HOLLE

1.690

DMD032302HT



Permasa 230 x 22.2 mm  
Spesori 1.6 mm

### DISK DIAMANTI PER BETON

10Pcs/set  
Fast cut



Kodi	Disku	Çmimi
DMD011152M	115 x 22.2 mm	<b>270</b>
DMD011252M	125 x 22.2 mm	<b>330</b>

**DISK DIAMANTI PER BETON**

**1.090**

**DMD012302M**



Permasa

230 mm x 22.4 mm

Max rotullimeve

6.600 / min

**DISK DIAMANTI PER BETON**



**1.250**

**DMD012302**

Blade width:10mm  
Fast cut



Permasat

230 x 22.2 x 10 mm

**DISK DIAMANTI PER BETON**



**1.250**

**DMD0123013**

Blade width:12mm  
Fast cut



Permasat

230 x 22.2 x 12 mm

**DISK DIAMANTI PER BETON**

**350**

**DMD011151**



Permasa

115 x 22.2 x 10 mm

**DISK DIAMANTI PER BETON**

**390**

**DMD011251**



Permasa

125 x 22.2 x 10 mm

**DISK DIAMANTI TURBO PAKETIM 10 COPE**

**320**

**DMD031152M**

10Pesiset  
Clean cut



Permasa

115 mm

Max rotullimeve

13.200 / min

**DISK DIAMANTI TURBO PAKETIM 10 COPE**

**350**

**DMD031252M**

10Pesiset  
Clean cut



Permasa

125 mm

Max rotullimeve

12.200 / min

**DISK DIAMANTI TURBO PAKETIM 5 COPE**

**550**

**DMD031802M**

Clean cut



Disku

180 x 22.2 mm



### DISK DIAMANTI TURBO PAKETIM 5 COPE

990

DMD032302M



Disku

230 x 22.2 mm

### KUPE ZMERILIMI DIAMANTI PER BETON

1.550

CGW021151



Diametri

115 mm

### KUPE ZMERILIMI DIAMANTI PER BETON

1.690

CGW021251



Diametri

125 mm

### KUPE ZMERILIMI TURBO DIAMANTI PER BETON

1.590

CGW011151



Diametri

115 mm

### KUPE ZMERILIMI TURBO DIAMANTI PER BETON

1.590

CGW011251



Diametri

125 mm

### DISK ME LETER ZMERILE 115 MM METALI



Kodi	Disku	Çmimi
FD1151	115mm x 22mm, P40	170
FD1152	115mm x 22mm, P60	170
FD1153	115mm x 22mm, P80	170

### DISK ME LETER ZMERILE INOX 115 MM



Kodi	Disku	Çmimi
FDZ1151	115mm x 22mm, P40	180
FDZ1152	115mm x 22mm, P60	180
FDZ1153	115mm x 22mm, P80	180

### DISK ME LETER ZMERILE INOX 125 MM



Kodi	Disku	Çmimi
FDZ1251	125mm x 22mm, P40	200
FDZ1252	125mm x 22mm, P60	200
FDZ1253	125mm x 22mm, P80	200

**DISK PASTRIMI ABRAZIV**

**90**

**MGD601151**



Disku

115 x 6.0 22.2 mm

**DISK PASTRIMI ABRAZIV**

**100**

**MGD601251**



Disku

125 x 6.0 22.2 mm

**DISK PASTRIMI ABRAZIV**

**220**

**MGD601801**



Disku

180 x 6.0 x 22.2 mm

**DISK PASTRIMI ABRAZIV**

**350**

**MGD602301**



Disku

230 x 6.0 x 22.2 mm

**DISK PRERES PER METAL / INOX**

**50**

**MCD101151**



Disku

115 x 1.0 x 22.2 mm

**DISK PRERES PER METAL / INOX**

**60**

**MCD101251**



Disku

125 x 1.0 x 22.2 mm

**DISK PRERES PER METAL / INOX**

**60**

**MCD121151**



Disku

115 x 1.2 x 22.2 mm

**DISK PRERES PER METAL / INOX**

**70**

**MCD121251**



Disku

125 x 1.2 x 22.2 mm

**SET ME 30 DISQE PRERES DHE PASTRIMI**



**1.990**

**MCD07630**

Te pershtatshme per: CAGLI7601 CAGLI76011 CAGLI76012 CAGLI76017

**SET ME 25 DISQE PRERES PER METAL / INOX**



**990**

**MCD11011525**

Disku 115 mm  
Trashesia 1.0 mm

**SET ME 25 DISQE PRERES PER METAL / INOX**



**1.490**

**MCD1012525**

Disku 125 mm  
Trashesia 1.0 mm

**SET ME 10 DISQE PRERES METAL / INOX**



**590**

**MCD121155**

Disku 115 x 22.2 mm  
Spesori 1.2 mm

**SET ME 25 DISQE PRERES METAL / INOX**



**1.250**

**MCD1211525**

Disku 115 x 22.2 mm  
Spesori 1.2 mm

**SET ME 50 DISQE PRERES METAL / INOX**



**2.150**

**MCD1211550**

Permasa 115 x 1.2 X 22.2 mm

**SET ME 10 DISQE PRERES METAL / INOX**



**690**

**MCD121255**

Diametri 125 x 1.2 X 22.2 mm

**DISK PRERES PER METAL/ INOX**



**150**

**MCD162301**

Diametri 230 mm x 1.6 x 22.2 mm



### DISK PRERES ABRAZIV METALI

180

MCD202302



Permasa

230 x 2 X 22.2 mm

### DISK PRERES ABRAZIV METALI

190

MCD302303



Permasa

230 x 1.9 22.2 mm

### DISQ PRERES PER METAL

350

MCD253551



Permasa

355 mm x 2.5 x 25 mm

### DISK PRERES ABRAZIV

360

MCD303551



Disku

355 x 3.0 x 25.4 mm

### SET ME 2 DISQE DRURI TE HOLLE

990

TSB1403



Permasa

140 x 1.0 x 20 mm  
24 T

### SET ME 2 DISQE DRURI TE HOLLE

**IRI**

24T

1.150

TSB1653



Permasa

165 x 1.0 x 20 mm  
24 T

### SET ME 2 DISQE DRURI TE HOLLE

**IRI**

24T

1.190

TSB1853



Permasa

185 x 1.0 x 20 mm  
24 T

### DISK DRURI



Kodi	Disku	Çmimi
TSB111555	115 mm x 22.2 mm	550
TSB116511	165 mm x 16 mm	690

### DISK DRURI 185 MM



Kodi	Diametri	Çmimi
TSB118515	185 mm x 20 mm / 40T	<b>890</b>
TSB118513	185 mm x 20 mm / 60 T	<b>1.090</b>

### SET ME 2 DISQE DRURI



**1.190**

TSB118510

Diametri 185 mm x 20 mm  
Dhembe 30T

### DISK DRURI 210 MM



**1.190**

TSB121022

Diametri 210 mm x 30 mm  
Dhembe 48T

### DISK DRURI 235 MM



**1.450**

TSB123523

Diametri 235 mm x 30 mm  
Dhembe 60T

### SET ME 2 DISQE DRURI



**1.690**

TSB1235252

**40T**



Diametri 235 mm x 30 mm  
Dhembe 40T

### DISK DRURI



Kodi	Diametri	Çmimi
TSB125423	254 mm x 30 mm / 60 T	<b>1.690</b>
TSB125425	254 mm x 30 mm / 40T	<b>1.450</b>

### DISK DRURI 305 MM



**2.690**

TSB130523

Diametri 305 mm x 30 mm  
Dhembe 60T

### DISK PRERES ALUMINI 210 MM



**1.590**

TSB321023

Diametri 210 mm x 30 mm  
Dhembe 60T

**DISK PRERES ALUMINI 254 MM**



**2.690**

**TSB3254210**

Diametri 254 mm x 30 mm  
Dhembe 100T

**DISK PRERES ALUMINI 305 MM**



**3.390**

**TSB3305212**

Diametri 305 mm x 30 mm  
Dhembe 120T

**MANDRINO ME ÇELES 13 MM**

**13mm (1/2")**



**350**

**KC1301**

Mandrino 13 mm

**ÇELES MANDRINO**

**13mm**



**150**

**CK1301**

Permasa 80 mm  
Per Mandrino 13 mm

**MANDRINO ME ÇELES ME ADAPTOR SDS-PLUS**

**13mm (1/2")**



**550**

**KC1301.1**

Mandrino 13 mm

**MANDRINO ME ÇELES 16 MM**

**16mm (5/8")**



**890**

**KC1601**

Mandrino 13 mm

**MANDRINO VETESHTRENGUESE PER VIDIA TOR**

**10mm (3/8")**



**350**

**KCL1028**

Mandrino 10 mm

**MANDRINO VETESHTRENGUESE PER VIDIA TOR**

**13mm (1/2")**



**550**

**KCL1301**

Mandrino 13 mm



### TAMPON GOMINE PER GURE FLEKSIBEL ME NGJITJE



Kodi	Permasa	Çmimi
APP0111151	115 mm	<b>360</b>
APP0111251	125 mm	<b>360</b>
APP0111801	180 mm	<b>650</b>

### TAMPON GOMINE PER GURE FLEKSIBEL



**390**  
APP0201801

Diametri 180 mm  
Kapja: M14

### DISK ZMERILIMI PER GURE FLEKSIBEL

**450**  
PD1151



Diametri 115 mm

### TAMPON LSHI PER POLIATRICE

**650**  
APB0111801



Permasa 180 mm  
Per Poliatrice AP14008

### SET ME 2 LETRA TANKU

**290**  
BSP020801



Permasa 100 x 610mm  
Ashpersia P80

### SET ME 5 LETRA ZMERILE ME NGJITJE PER ZMERILUESE RRETHORE

**160**  
AKRS125051



Permasa 125 mm  
Ashpersia 3 x P80 / 2 x P120

### SET ME 5 LETRA ZMERILE ME NGJITJE PER ZMERILUESE RRETHORE

**180**  
AKRS150051



Permasa 150 mm  
Ashpersia 3 x P80 / 2 x P120

### SET ME 6 LETRA ZMERILE ME NGJITJE PER ZMERILUESE MURESH

**590**  
AKRS225061



Permasa 225 mm  
Ashpersia 1xP60 / 1xP80 / 1xP60 / 1xP120 / 2xP150 / 1x P240

### LETER ZMERILE 115X5000 MM

**ERE**



Kodi	Disku	Çmimi
AKHS04065	115x5000 mm, P40	<b>450</b>
AKHS06065	115x5000 mm, P60	<b>390</b>

### LETER ZMERILE 115X5000 MM

**ERE**



Kodi	Disku	Çmimi
AKHS08065	115x5000 mm, P80	<b>390</b>
AKHS10065	115x5000 mm, P100	<b>350</b>

### LETER ZMERILE 115X5000 MM

**ERE**



Kodi	Disku	Çmimi
AKHS12065	115x5000 mm, P120	<b>350</b>
AKHS15065	115x5000 mm, P150	<b>330</b>

### LETER ZMERILE 115X5000 MM

**ERE**



Kodi	Disku	Çmimi
AKHS18065	115x5000 mm, P180	<b>330</b>
AKHS24065	115x5000 mm, P240	<b>300</b>

### LETER UJI E ZEZE 230 X 280 MM

**ERE**



Kodi	Permasa/Grana	Çmimi
AKHS028016	230X280 mm, P280	<b>1.690</b>
AKHS040016	230X280 mm, P400	<b>1.690</b>
AKHS100016	230X280 mm, P1000	<b>1.690</b>
AKHS150016	230X280 mm, P1500	<b>1.690</b>
AKHS200016	230X280 mm, P2000	<b>1.690</b>

### SET ME KALLAMA NGJITES

1Kg

**11x300mm**

**1.450**

**AKTGS3011**



Permasa

30 cm

Pesha

1 Kg

### SET ME 6 KALLAMA NGJITES

**290**

**AKTGS2061**



Diametri: 11.2 mm  
Gjatesia: 20 cm

### THIKA PLANI 2 COPE

**350**

**EPB820121**

**HSS**

**2PCS/SET**  
82x5.5x1.2mm

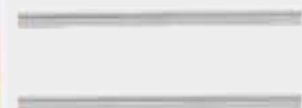

Permasa  
Materiali

82 x 5.5 x 1.2 mm  
HSS

**SET ME 5 LAMA SHARRE VERTIKALE PER DRU**

**120**  
**JSBT111C**



Permasat

74 mm (6")

**SET ME 5 LAMA SHARRE VERTIKALE PER DRU**

**140**  
**JBT144D**



Permasat

74 mm (6")

**SET ME 5 LAMA SHARRE VERTIKALE PER DRU**

**180**  
**JBT1101B**



Permasat

74 mm (6")

**SET ME 5 LAMA SHARRE HORIZONTAL PER DRU ME GOZHDE**

**890**  
**RSB1111DF**



Permasat

225 mm (9")

**SET ME 5 LAMA SHARRE HORIZONTAL PER DRU**

**350**  
**RSB611D**



Mandrino

150 mm (6")

**SET ME 2 LAMA SHARRE HORIZONTAL PER DRU**

**180**  
**SSB644D**



Permasa

150mm x 19mm x 1.25mm

6TPI

**SET ME 5 LAMA SHARRE HORIZONTAL PER METAL**

**550**  
**RSB922EF**



Permasat

150 mm (6")

**SET ME 2 LAMA SHARRE HORIZONTAL PER METAL**

**360**  
**SSB922EF**



Permasa

150mm x 19mm x 1.25mm

18TPI



### SET ME 5 FREZA TUNGESTENI PER METAL

3.390

HRRC0051



Boshti 6 mm  
 Permase 8 mm  
 Sasia 5 cope

### SET ME GOTA KARBITI + ADAPTORE

1.690

HSB4061



Permase 33,53,73,83 mm

### FURCE KUPE ME TEL TE IMET BRONXI

290

WB10751



Permase 75 mm  
 Kapja M14

### FURCE KUPE ME TEL TE IMET BRONXI

450

WB11001



Permase 100 mm  
 Kapja M14

### FURCE KUPE ME TEL TE IMET BRONXI

550

WB11251



Permase 125 mm

### FURCE KUPE ME TEL TE IMET BRONZI E ZEZE

LONG LIFE x 3  
 Vibration Control



Kodi	Disku	Çmimi
WB10755	75 mm / M14	350
WB11005	100 mm / M14	550

### FURÇE KUPE ME TEL TE ASHPER



Kodi	Disku	Çmimi
WB20751	75 mm / M14	350
WB21001	100 mm / M14	450
WB21251	125 mm / M14	650

### FURCE KUPE ME TEL TE ASHPER E ZEZE



Kodi	Disku	Çmimi
WB21751	75 mm / M14	350
WB20755	75 mm / M14	390
WB21005	100 mm / M14	550

### FURÇE KUPE ME TEL TE IMET PER TRAPAN



Kodi	Permasa	Çmimi
WB30501	50 mm	<b>130</b>
WB30751	75 mm	<b>130</b>

### FURÇE KUPE ME FIJE NEJLONI



Kodi	Permasa	Çmimi
WB30505	50 mm	<b>240</b>
WB30755	75 mm	<b>360</b>

### FURÇE RRETHORE ME TEL TE IMET PER TRAPAN



Kodi	Permasa	Çmimi
WB40501	50 mm	<b>120</b>
WB40751	75 mm	<b>160</b>
WB41001	100 mm	<b>180</b>

### FURÇE RRETHORE ME FIJE NEJLONI



Kodi	Permasa	Çmimi
WB40755	75 mm	<b>270</b>
WB41005	100 mm	<b>350</b>

### FURÇE TELI (6")

**550**

WB51501



Permasa 150 mm  
Perdorimi Zmeriluese bango

### FURÇE RRETHORE ME TEL TE IMET PER TRAPAN

**150**

WB70241



Permasa 25 mm

### FURÇE TELI ME DOREZE PLASTIKE

**150**

HWB02250



Permasa 250 mm

### SET ME 7 FURÇA ME TEL TE IMET

**7PCS/SET**

**990**

WB10071

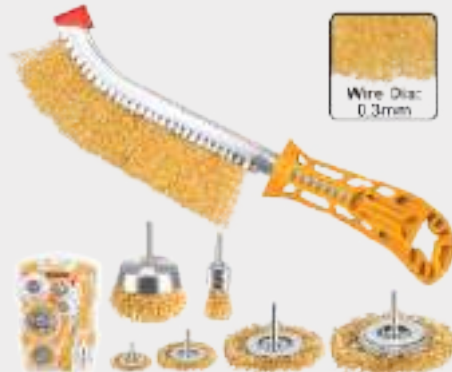

Seti 7 cope

## DISK MELAMINE DHE ALUMINI LP85M

MADE IN ITALY

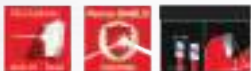
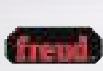
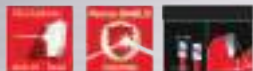

**FR13A002H**

190 x 2.5 x 30 mm Z54

**5.990**

**FR15A001M**

210 x 2.5 x 30 mm Z54

**6.590**

**FR19A001H**

230 x 2.8 x 30 mm Z64

**7.590**

## DISK ALUMINI

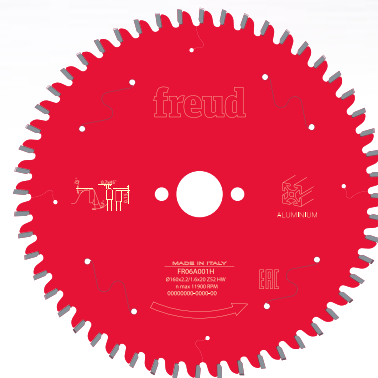
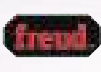
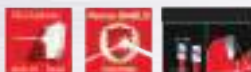
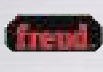
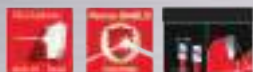

**FR23A001M**

250 x 2.8 x 30 mm Z80

**8.500**

**FR28A001M**

300 x 2.8 x 30 mm Z96

**8.970**

**FR30A001M**

315 x 2.8 x 30 mm Z96

**9.900**

## DISK MELAMINE LG3D

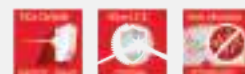
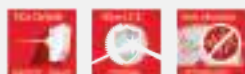
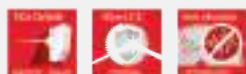
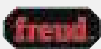
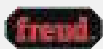

**LG3D0400**

250 x 3.2 x 30 mm Z80

**8.900**

**LG3D0600**

300 x 3.2 x 30 mm Z96

**10.500**

**LG3D0900**

350 x 3.2 x 30 mm Z108

**11.900**



## DISK MELAMINE SILENCIOZ LU3D

MADE IN ITALY

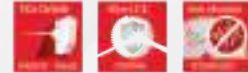
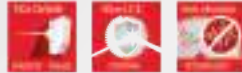

**LU3D0400**  
250 x 3.2 x 30 mm Z80

**11.900**



**LU3D0600**  
300 x 3.5 x 30 mm Z96

**12.500**



**LU3D0900**  
350 x 3.5 x 30 mm Z108

**14.900**

## DISK ALUMINI LU5D / SILENCIOZ



**LU5D0800**  
250 x 3.5 x 30 mm Z80

**9.900**

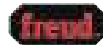

**LU5D1200**  
300 x 3.5 x 30 mm Z96

**11.500**



**LU5D1700**  
350 x 3.5 x 30 mm Z108

**13.900**



## DISK ALUMINI LU5B

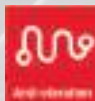

**LU5B2300**  
400 x 3.5 x 32 mm Z120

**15.900**

## DISK ALUMINI LU5B

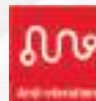

**LU5B2700**  
450 x 4.0 x 30 mm Z128

**19.900**



Disk per prerjen e Aluminit.  
Per prerje te shpejte,  
preçize dhe silencioze.

## DISK HEKURI NE TE THATE

MADE IN ITALY



Disk per prerjen e hekurit ne te thate me nje preçizion te larte. Ky disk eshte krijuar posaçerisht per profesionistet

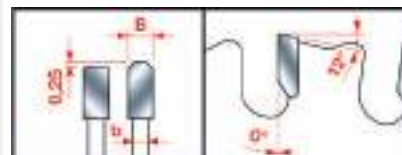

**LU6A1000**  
254 x 2.4 x 25 mm Z60

**8.900**

**LU6A1200**  
305 x 2.6 x 25 mm Z80

**14.500**

## DISK DRURI



**LU1E0100**  
250 mm Z 24

**4.900**

**LU1A0100**  
300 x 4.4 x 30 Z36

**9.900**

**LU1A0200**  
350 x 4.4 x 30 Z42

**11.500**

## DISK ME VIDIUM PER DRU LU2A/B

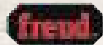
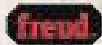

**LU2A1600**  
250 x 3.2 x 30 Z30

**6.500**

**LU2A1700**  
250 x 3.2 x 30 Z40

**7.900**

**LU2A1900**  
300 x 3.2 x 30 Z36

**8.500**

## DISK DRURI

MADE IN ITALY



**9.900**

**LU2A2100**  
300 x 3.2 x 30 mm Z48



**10.900**

**LU2A2500**  
350 x 3.5 x 30 mm Z42



**18.500**

**LU2A3300**  
400 x 4.0 x 30 mm Z60



**18.900**

**LU2B1900**  
400 x 4.0 x 30 mm Z96

## DISK UNIVERSAL



**LU2A3100**  
400 x 4.0 x 30 mm Z48

**13.900**

## DISK DRURI UNIVERSAL



**LU1C0400**  
300 x 3.2 x 30 mm Z26

**8.500**

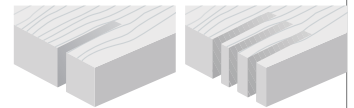

Disk druri universal eshte dizenuar per tu perdorur ne te gjitha llojet e drurit, dhe te ruaj te njejtin preçizion gjate prerjes.

## DISK PER ÇARJE LM02



**5.500**

**LM010100**  
180 x 2.2 x 40 mm Z16+2



**8.500**

**LM020600**  
300 x 2.8 x 30 mm Z20 + 2



**10.500**

**LM021200**  
350 x 3.0 x 30 mm Z24 + 4



**9.500**

**LM021300**  
350 x 3.0 x 60 mm Z24 + 4



# Puntot tona

## SDS-plus dhe SDS-Max



Ky program plotëson të gjitha nevojat që lidhen me shpimin duke ofruar produkte me cilësi të lartë.

Ndahet në dy kategori: punto me kapje SDS-plus dhe punto SDS-max.

### SDS-plus

#### Punto shpuese për prerje të shufrave të armaturave

Ideale për shpimin në beton arme.

#### Punto SDS-plus me 2 koka

Më të shpejtat gjatë shpimit që mund të gjenden në treg. Ideale për të siguruar autonomi më të madhe në veglat me bateri.

#### Punto SDS-plus me 4 koka

Jetegjatesi më të madhe, ideale për aplikime të rënda në të gjitha materialet e ndërtimit.

#### Punto SDS-plus me 4 koka me aspirim

Me jetegjatat në kategori sigurojnë një vrimë të pastër pa mbetje, ideale për përgatitjen e injeksioneve kimike, rezinave epokside dhe teknike.

#### Gotë me video SDS-plus

Me kapacitet të lartë shpimi, ideale për shpime në beton, tulla dhe gur (deri në Ø 50 mm)



### SDS-max

#### Punto SDS-max me 4 koka

Punto të gjeneratës së fundit për të nxjerrë performancë max të matrapikëve, gjithashtu ideale edhe në punimet më të vështira në të gjithë materialet e ndërtimit.

#### Punto SDS-max me 4 koka me aspirim

Më të qëndrueshmet në kategori, sigurojnë një vrimë të pastër pa mbetje, ideale për përgatitjen e injeksioneve kimike, rezinave epokside dhe teknike.

#### Punto Gote SDS-max

Dizajn i përmirësuar për të garantuar performancë të lartë kur shponi në beton, tulla dhe gurë.

#### Gote me video SDS-max

Kapacitet i lartë shpimi, të disponueshme edhe me sistem modular dhe shtesa, ideale për shpime në beton, tulla dhe gurë.



Puntot Hikoki janë të certifikuara nga organi ndërkombëtar PGM: Certifikimi PGM siguron standarde të larta në ndërtim dhe një nivel të lartë në shkallën e saktësisë së diametrit të vrimës. Ky certifikim bëhet një kërkesë thelbësore për të garantuar një kapje të përsosur në vrimat e ankorimit.



Te certifikuara nga institucioni ndërkombëtare PGM

## PUNTO SDS-PLUS ME 2 KOKA



Kodi	Dimensioni	Çmimi
782401	4 x 110 mm	<b>490</b>
782402	4 x 160 mm	<b>650</b>
782404	5 x 110 mm	<b>390</b>
782406	5 x 160 mm	<b>450</b>
782407	5 x 210 mm	<b>790</b>
782408	5 x 260 mm	<b>990</b>
782409	5 x 310 mm	<b>1.390</b>
782415	6 x 110 mm	<b>390</b>
782416	6 x 160 mm	<b>450</b>
782417	6 x 210 mm	<b>750</b>
782418	6 x 260 mm	<b>950</b>
782419	6 x 310 mm	<b>1.350</b>
782430	7 x 160 mm	<b>490</b>
782432	8 x 110 mm	<b>450</b>
782433	8 x 160 mm	<b>490</b>
782434	8 x 210 mm	<b>550</b>
782435	8 x 260 mm	<b>790</b>
782436	8 x 310 mm	<b>990</b>
782438	8 x 460 mm	<b>1.790</b>
782444	10 x 110 mm	<b>490</b>
782445	10 x 160 mm	<b>550</b>
782446	10 x 210 mm	<b>650</b>
782447	10 x 260 mm	<b>750</b>

## PUNTO SDS-PLUS ME 2 KOKA



Kodi	Dimensioni	Çmimi
782448	10 x 310 mm	<b>990</b>
782458	12 x 160 mm	<b>750</b>
782459	12 x 210 mm	<b>950</b>
782460	12 x 260 mm	<b>1.250</b>
782461	12 x 310 mm	<b>1.290</b>
782463	12 x 450 mm	<b>1.900</b>
782471	14 x 160 mm	<b>1.090</b>
782472	14 x 210 mm	<b>1.190</b>
782473	14 x 260 mm	<b>1.550</b>
782474	14 x 310 mm	<b>1.590</b>
782475	14 x 450 mm	<b>2.350</b>
782483	16 x 160 mm	<b>1.350</b>
782484	16 x 210 mm	<b>1.390</b>
782485	16 x 260 mm	<b>1.900</b>
782486	16 x 310 mm	<b>2.500</b>
782493	18 x 250 mm	<b>3.250</b>
782501	20 x 250 mm	<b>3.300</b>
782504	20 x 600 mm	<b>3.990</b>
782508	22 x 450 mm	<b>4.500</b>
782515	24 x 450 mm	<b>4.900</b>
782518	25 x 450 mm	<b>4.900</b>

## PUNTO SDS-PLUS ME 4 KOKA



Kodi	Dimensioni	Çmimi
783201	5 x 110 mm	<b>690</b>
783202	5 x 160 mm	<b>750</b>
783208	6 x 110 mm	<b>790</b>
783209	6 x 160 mm	<b>850</b>
783210	6 x 210 mm	<b>990</b>
783211	6 x 260 mm	<b>1.350</b>
783212	6 x 310 mm	<b>1.790</b>
783222	8 x 160 mm	<b>890</b>
783223	8 x 210 mm	<b>990</b>
783224	8 x 260 mm	<b>1.290</b>
783225	8 x 310 mm	<b>1.790</b>
783231	10 x 115 mm	<b>950</b>
783232	10 x 160 mm	<b>990</b>
783233	10 x 210 mm	<b>1.150</b>
783234	10 x 260 mm	<b>1.350</b>
783235	10 x 310 mm	<b>1.650</b>
783237	10 x 455 mm	<b>2.900</b>

## PUNTO SDS-PLUS ME 4 KOKA



Kodi	Dimensioni	Çmimi
783244	12 x 165 mm	<b>1.190</b>
783245	12 x 215 mm	<b>1.450</b>
783246	12 x 265 mm	<b>1.590</b>
752777	14 x 160 mm	<b>1.950</b>
783255	14 x 165 mm	<b>1.490</b>
752778	14 x 210 mm	<b>1.900</b>
783256	14 x 215 mm	<b>1.900</b>
783257	14 x 260 mm	<b>2.390</b>
783258	14 x 315 mm	<b>2.500</b>
752791	16 x 160 mm	<b>2.900</b>
783267	16 x 210 mm	<b>3.300</b>
783268	16 x 265 mm	<b>3.300</b>
783269	16 x 315 mm	<b>3.950</b>
783270	16 x 455 mm	<b>3.990</b>
783273	18 x 250 mm	<b>5.390</b>
783275	20 x 250 mm	<b>4.900</b>
783276	20 x 450 mm	<b>5.500</b>

**PUNTO SDS-MAX**



Kodi	Dimensio	Çmimi
750910	12 x 340 mm	<b>4.990</b>
750914	14 x 340 mm	<b>4.900</b>
750917	15 x 340 mm	<b>4.900</b>
754301	16 x 340 mm	<b>4.900</b>
754302	16 x 540 mm	<b>5.900</b>
754305	18 x 340 mm	<b>5.900</b>
754306	18 x 540 mm	<b>6.500</b>
754309	20 x 320 mm	<b>5.900</b>
754310	20 x 520 mm	<b>6.500</b>
754313	22 x 320 mm	<b>5.900</b>
754314	22 x 520 mm	<b>6.500</b>
754317	24 x 320 mm	<b>6.900</b>
754318	24 x 520 mm	<b>8.500</b>
754319	25 x 320 mm	<b>6.900</b>
754320	25 x 520 mm	<b>8.900</b>
754325	28 x 570 mm	<b>9.900</b>

**DALTE SDS-PLUS E GJERE**



**751592** E GJERE 40 X 250 MM **1.790**

**DALTE SDS-PLUS E SHESHTE**



**751591** E SHESHTE 20 X 250 MM **990**

**DALTE SDS-PLUS E SHESHTE**



**751132** E SHESHTE 20 X 250 MM **1.490**

**DALTE SDS-PLUS ME MAJE**



**751590** ME MAJE 250 MM **990**

**DALTE SDS-PLUS ME MAJE VETEMPREHESE**

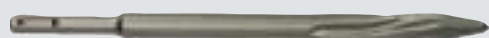

**751587** VETEMPREHESE 250 MM **1.250**

**DALTE SDS-MAX ME MAJE**



**750991** DALTE ME MAJE 400 MM **1.590**

**750992** DALTE ME MAJE 600 MM **2.290**

**DALTE SDS-MAX ME MAJE TE SHESHTE**



**LETER ZMERILE 115X5000 MM**

**750994** ME MAJE TE SHESHTE 25X400 MM **1.590**

**750995** ME MAJE TE SHESHTE 25X600 MM **1.990**

**DALTE SDS-MAX ME MAJE TE SHESHTE**



**750997** ME MAJE TE SHESHTE 50X400 MM **2.650**

**DALTE SDS-MAX ME MAJE VETEMPREHESE**



**751032** ME MAJE VETEMPREHESE 400 MM **2.650**

**DALTE MATRAPIKU HEXAGON ME MAJE**



**751543** ME MAJE HEXAGON 410 MM **4.500**

**DALTE MATRAPIKU HEXAGON ME MAJE**



**751582** ME MAJE HEXAGON 550 MM **5.500**

**DALTE MATRAPIKU HEXAGON E SHESHTE**



**751544** E SHESHTE HEXAGON 410 MM **4.500**

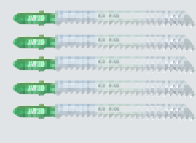
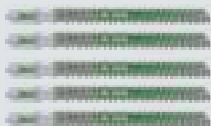
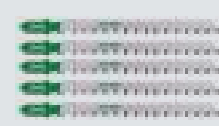
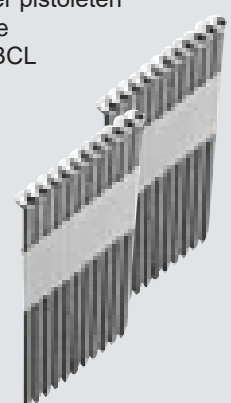

**40030019**Set me 32 maja  
per vidiator  
Kapja 1/4"**2.350****752414**Disk per sharre rrethore  
Me Z18 dhembë  
165x20 mm**4.500****40030021**Set me 23 maja  
me goditje  
+ adaptor**2.250****782532**Set me punto  
SDS-Plus 5 cope  
(5-8 mm)**1.290****40030025**Set me 7 koka kriketi ajri  
Kapja 1/2"  
adaptor  
me kapje 1/4"**3.950****714833**Graso per ingranzhe  
100 gr**990****751875**Adaptor 1/2" F-1/4" F  
me koke magnetike**950****Disk per sharre rrethore****Lama sharre për : Dru, plastik, metal****750043**Lama sharre 5-cope  
74 x 4.0 mm për dru**850****750019**Lama sharre 5-cope  
74 x 4 mm për dru  
dhe melamin**990****750021**Lama sharre 5-cope  
74 x 3.0 mm për  
dru dhe plastik**550****750029**Lama sharre  
5-cope për dru  
74 x 4.0 mm**1.450****750012**Lama sharre për  
metal 100.4 x 1 mm**890****750027**Lama sharre 5-cope  
91 x 3 mm për  
pllaka druri**1.390****750028**Lama sharre 5-cope te  
gjata 132 x 1.7 mm  
për dru**1.450****750532**Lama sharre  
3- Cope HSS  
14/18 TPI**9.900****750470**Thike zdrukthi  
82 mm**1.090****753612**Gozhde 55 mm  
per Pistoletë  
(paketimi 3000 cope)**8.500****753614**Gozhde Per pistoletën  
e gozhdeve  
NR1890DBCL**8.500**

## PUNTO DRURI



Kodi	Dimensioni	Çmimi
781902	4 x 75 mm	<b>65</b>
781903	5 x 86 mm	<b>70</b>
781904	6 x 92 mm	<b>80</b>
781905	7 x 109 mm	<b>90</b>
781906	8 x 117 mm	<b>99</b>
781907	9 x 125 mm	<b>110</b>
781908	10 x 133 mm	<b>120</b>
781910	12 x 150 mm	<b>290</b>
781912	14 x 150 mm	<b>320</b>
781913	15 x 160 mm	<b>350</b>
781914	16 x 160 mm	<b>390</b>
781936	16 x 250 mm	<b>750</b>

## PUNTO DRURI E SHESHTË



Kodi	Dimensioni	Çmimi
781702	8 x 150 mm	<b>290</b>
781703	10 x 150 mm	<b>290</b>
781704	12 x 150 mm	<b>290</b>
781705	13 x 150 mm	<b>290</b>
781706	14 x 150 mm	<b>320</b>
781707	15 x 150 mm	<b>330</b>
781708	16 x 150 mm	<b>350</b>
781709	17 x 150 mm	<b>380</b>
781710	18 x 150 mm	<b>390</b>
781711	19 x 150 mm	<b>420</b>
781712	20 x 150 mm	<b>430</b>
781713	22 x 150 mm	<b>450</b>
781714	24 x 150 mm	<b>490</b>
781715	25 x 150 mm	<b>520</b>
781716	26 x 150 mm	<b>530</b>
781717	28 x 150 mm	<b>590</b>
781718	30 x 150 mm	<b>590</b>
781719	32 x 150 mm	<b>650</b>
781720	34 x 150 mm	<b>690</b>
781721	35 x 150 mm	<b>690</b>
781722	36 x 150 mm	<b>690</b>
781724	40 x 150 mm	<b>750</b>

## PUNTO DRURI LEWIS



Kodi	Dimensioni	Çmimi
781803	8 x 230 mm	<b>690</b>
781805	10 x 230 mm	<b>750</b>
781807	12 x 230 mm	<b>850</b>
781809	14 x 230 mm	<b>890</b>
781811	16 x 230 mm	<b>1.090</b>
781813	18 x 230 mm	<b>1.250</b>
781815	20 x 230 mm	<b>1.350</b>
781817	22 x 230 mm	<b>1.450</b>
781819	24 x 230 mm	<b>1.750</b>
781821	26 x 230 mm	<b>2.090</b>
781835	12 x 320 mm	<b>1.090</b>
781855	10 x 460 mm	<b>1.250</b>
781857	12 x 460 mm	<b>1.350</b>
781859	14 x 460 mm	<b>1.530</b>
781863	18 x 460 mm	<b>1.790</b>
781865	20 x 460 mm	<b>1.990</b>
781867	22 x 460 mm	<b>2.250</b>
781869	24 x 460 mm	<b>2.690</b>

## PUNTO BETONI PA SHLICA



Kodi	Dimensioni	Çmimi
780852	4 x 85 mm	<b>250</b>
780854	5 x 150 mm	<b>350</b>
780857	6 x 100 mm	<b>250</b>
780858	6 x 150 mm	<b>390</b>
780859	6 x 200 mm	<b>450</b>
780866	8 x 120 mm	<b>290</b>
780867	8 x 200 mm	<b>550</b>
780868	8 x 400 mm	<b>1.250</b>
780871	10 x 120 mm	<b>390</b>
780872	10 x 200 mm	<b>590</b>
780873	10 x 400 mm	<b>1.250</b>
780875	12 x 150 mm	<b>550</b>
780876	12 x 200 mm	<b>850</b>
780877	12 x 400 mm	<b>1.350</b>
780880	14 x 150 mm	<b>890</b>
780881	14 x 200 mm	<b>1.090</b>
780882	14 x 400 mm	<b>1.450</b>
780885	16 x 160 mm	<b>1.090</b>
780886	16 x 400 mm	<b>1.790</b>
780888	18 x 160 mm	<b>1.550</b>

## PUNTO FREZE PER TRAPANET MAGNETIK



Kodi	Dimensioni	Çmimi
754401	12 x 30 mm	<b>3.300</b>
754402	13 x 30 mm	<b>3.590</b>
754403	14 x 30 mm	<b>3.590</b>
754404	15 x 30 mm	<b>3.690</b>
754405	16 x 30 mm	<b>3.750</b>
754406	17 x 30 mm	<b>3.790</b>
754407	18 x 30 mm	<b>3.850</b>
754408	19 x 30 mm	<b>3.890</b>
754409	20 x 30 mm	<b>3.950</b>
754410	21 x 30 mm	<b>3.990</b>
754411	22 x 30 mm	<b>4.500</b>
754413	23 x 30 mm	<b>4.590</b>
754414	24 x 30 mm	<b>4.790</b>
754415	25 x 30 mm	<b>4.990</b>
754417	26 x 30 mm	<b>4.990</b>
754418	27 x 30 mm	<b>5.500</b>
754419	28 x 30 mm	<b>5.900</b>
754421	30 x 30 mm	<b>5.900</b>
754423	32 x 30 mm	<b>6.500</b>
754424	33 x 30 mm	<b>7.500</b>
754425	34 x 30 mm	<b>7.900</b>
754427	36 x 30 mm	<b>8.500</b>
754429	38 x 30 mm	<b>8.900</b>
754431	40 x 30 mm	<b>9.900</b>

## ADAPTOR PER GOTA HSS-BI-METALI

**752182**

Adaptor për gotat HSS-BI-Metali Hexagon 14-35 mm

**690**



**752184**

Adaptor për gotat HSS-BI-Metali SDS-Plus 30-38 mm

**1.290**



**752186**

Adaptor për gotat HSS-BI-Metali Hexagon 40-152 mm

**1.450**



**752189**

Adaptor SDS Plus për gotat HSS-BI-Metali Sds-Plus 40-152 mm

**1.790**



## PUNTO ÇENTRUESE RATIO

**760074**

Punto çentruese ratio Gjatësia 155 mm / Diametri 12 mm

**3.500**



## PUNTO QENDRE

**754495**

Punto qëndrore 6.35 x 79 mm për trapan magnetik

**1.550**



## GOTE HSS-BI-METALI



Kodi	Dimensioni	Çmimi
752102	16 mm	<b>690</b>
752105	20 mm	<b>690</b>
752107	22 mm	<b>890</b>
752109	25 mm	<b>890</b>
752110	27 mm	<b>990</b>
752113	30 mm	<b>1.090</b>
752114	32 mm	<b>1.090</b>
752116	35 mm	<b>1.090</b>
752117	37 mm	<b>1.090</b>
752118	38 mm	<b>1.190</b>
752119	40 mm	<b>1.350</b>
752122	44 mm	<b>1.550</b>
752125	51 mm	<b>1.590</b>
752131	60 mm	<b>1.790</b>
752135	68 mm	<b>1.900</b>
752141	86 mm	<b>2.500</b>
752146	102 mm	<b>3.090</b>



## GOTA DIAMANTI PER GURE FLEKSIBEL



Kodi	Dimensioni	Çmimi
4100522	6 mm, M14	<b>2.790</b>
4100524	8 mm, M14	<b>2.790</b>
4100525	10 mm, M14	<b>2.790</b>
4100526	12 mm, M14	<b>2.900</b>

Kodi	Dimensioni	Çmimi
4100527	14 mm, M14	<b>3.200</b>
4100528	16 mm, M14	<b>3.300</b>
4100529	20 mm, M14	<b>4.250</b>
4100530	25 mm, M14	<b>4.500</b>
4100531	30 mm, M14	<b>5.500</b>
4100532	32 mm, M14	<b>5.900</b>
4100533	35 mm, M14	<b>5.900</b>





# « Prodhuar në Holzgerlingen »

## Produktiviteti

RUKO ka një park modern makinerish me një kapacitet të lartë prodhimi. Duke synuar një rritje të përhershme të produktivitetit, RUKO investon vazhdimisht në teknologjitë më të fundit.

Makinëritë e përpunimit të metalit CNC plotësisht të automatizuara lehtësojnë përmes teknikës së bluarjes cBN (nitrid kubik bor), saktësinë më të lartë dhe mprehtësinë maksimale në prodhimin e puntovë. Aktualisht, RUKO ka një nga metodat më moderne të prodhimit në botë.

## Inovacioni

Departamenti ynë i zhvillimit është duke punuar vazhdimisht për të përmirësuar produktet aktuale, si dhe për të zhvilluar rodukte të reja dhe konkurruese në treg.

Nga zhvillimi (CAD) përmes programimit CNC të simulimi i prodhimit, të gjithë hapat e punës prodhohen nga sistemet kompjuterike të lidhura me njëra-tjetrën. Si në të ardhmen e afërt ashtu edhe në të tashmen, pika e fortë e RUKO-s është zhvillimi dhe përmirësimi i gjithë programit të tij të përpunimit të metaleve.



## Menaxhimi i cilësisë

Kontrolli modern i cilësisë garanton mirëmbajtjen e përhershme të standardeve të cilësisë së lartë. Të dhënat unike merren me pajisjet më të fundit të verifikimit optik që janë si pajisje standarde.

Testimi i materialeve gjatë proceseve të prodhimit është pjesë e sigurimit ditor të cilësisë. Certifikimi sipas DIN EN ISO 9001: 2008 konfirmon filozofinë e cilësisë të garantuar prej vitesh.



made in  
Germany

**RUKO**

# E REJA **RUKO ULTIMATECUT** PUNTO ME MAJË KONIKE

- ▶ x5 MË TEPËR SHPIME
- ▶ KURSEN ENERGJI PUNE
- ▶ DERI NË 50% MË SHUMË SHPEJTËSI SHPIMI

QENDËRZIM PREÇIZ  
PA FORCË SHTYTËSE  
DHE SHPEJTËSI SHPIMI  
NË NJË SËRË SIPËRFAQESH  
TË NDRYSHME METALIKE.

BOSHTI TREKËNDOR SIGURON  
NJË TRASMETIM TË PLOTË  
TË FUQISË SË MAKINERISË  
DHE PA SHTRËNGIME TË TJERA  
TË NEVOJSHME GJATË PUNËS.



## **RUKO FLOWSTEP** tip

Qënderzim preciz pa forcë shtytëse dhe shpejtësi shpimi në një sere sipërfaqesh të ndryshme metalike.



## **RUKO FLOWSTEP** Technology

Gjeometria unike e fundit e puntove RUKO-S rezulton në një proces shpimi shumë më të butë dhe më të shpejtë.

**PUNTO METALI KONIKE HSS-G TWIST / DIN 338**



Aplikimet:

Çelik	●
Alumin	●
Dru	●
Tunxh	●
Bronz	○
Plastik	●
Gize	○
Pexiglas	●

Kodi	Ø	L1 mm	L2 mm	Paketimi	Cmimi
259010	1.0 mm	34 mm	12 mm	10	<b>320</b>
259015	1.5 mm	40 mm	18 mm	10	<b>349</b>
259020	2.0 mm	49 mm	24 mm	10	<b>359</b>
259025	2.5 mm	57 mm	30 mm	10	<b>369</b>
259030	3.0 mm	61 mm	33 mm	10	<b>390</b>
259035	3.5 mm	70 mm	39 mm	10	<b>460</b>
259040	4.0 mm	75 mm	43 mm	10	<b>490</b>
259042	4.2 mm	75 mm	43 mm	10	<b>590</b>
259045	4.5 mm	80 mm	47 mm	10	<b>620</b>
259050	5.0 mm	86 mm	52 mm	10	<b>660</b>
259055	5.5 mm	93 mm	57 mm	5	<b>750</b>
259060	6.0 mm	93 mm	57 mm	5	<b>790</b>
259065	6.5 mm	101 mm	63 mm	5	<b>880</b>
259070	7.5 mm	109 mm	69 mm	5	<b>890</b>
259080	8.0 mm	117 mm	75 mm	5	<b>1.250</b>
259090	9.0 mm	125 mm	81 mm	1	<b>1.490</b>
259095	9.5 mm	125 mm	81 mm	1	<b>1.590</b>
259100	10.0 mm	133 mm	87 mm	1	<b>1.850</b>
259110	11.0 mm	142 mm	94 mm	1	<b>1.990</b>
259120	12.0 mm	151 mm	101 mm	1	<b>2.350</b>
259130	13.0 mm	151 mm	101 mm	1	<b>2.490</b>

**PUNTO METALI ME MAJE KONIKE HSS-CO5 TWIST / DIN 338**



Aplikimet:

Inox	●
Çelik	●
Alumin	●
Tunxh	●
Bronz	○
Plastik	●
Gize	○
Pexiglas	●
Dru	●

Kodi	Ø	L1 mm	L2 mm	Paketimi	Cmimi
259010E	1.0 mm	34 mm	12 mm	10	<b>450</b>
259015E	1.5 mm	40 mm	18 mm	10	<b>450</b>
259020E	2.0 mm	49 mm	24 mm	10	<b>490</b>
259025E	2.5 mm	57 mm	30 mm	10	<b>550</b>
259030E	3.0 mm	61 mm	33 mm	10	<b>590</b>
259035E	3.5 mm	70 mm	39 mm	10	<b>660</b>
259040E	4.0 mm	75 mm	43 mm	10	<b>750</b>
259042E	4.2 mm	75 mm	43 mm	10	<b>890</b>
259045E	4.5 mm	80 mm	47 mm	10	<b>890</b>
259050E	5.0 mm	86 mm	52 mm	10	<b>920</b>
259055E	5.5 mm	93 mm	57 mm	5	<b>1.100</b>
259060E	6.0 mm	93 mm	57 mm	5	<b>1.190</b>
259065E	6.5 mm	101 mm	63 mm	5	<b>1.290</b>
259070E	7.0 mm	109 mm	69 mm	5	<b>1.350</b>
259075E	7.5 mm	109 mm	69 mm	5	<b>1.450</b>
259080E	8.0 mm	117 mm	75 mm	5	<b>1.650</b>
259085E	8.5 mm	117 mm	75 mm	1	<b>1.750</b>
259090E	9.0 mm	125 mm	81 mm	1	<b>1.990</b>
259095E	9.5 mm	125 mm	81 mm	1	<b>2.200</b>
259100E	10.0 mm	133 mm	87 mm	1	<b>2.390</b>
259110E	11.0 mm	142 mm	94 mm	1	<b>2.790</b>
259120E	12.0 mm	151 mm	101 mm	1	<b>2.890</b>
259130E	13.0 mm	151 mm	101 mm	1	<b>2.990</b>



## PUNTO COBALTI, DIN 338, TIP VA, HSSE-CO5 - GAMË PROFESIONALE



**Profili i kanalit:** Normal  
**Brendia:** Cobalt  
**Forma:** C, me pikë përqendrimi

Shpim me këndin e duhur dhe me rezistencë nxehtësie.

Ideale për shpimin e çelikut me rezistencë të lartë.



Kodi	Permasa	L1 mm	L2 mm	Paketimi	Cmimi
215020	2.0	49	24	10	<b>120</b>
215025	2.5	57	30	10	<b>130</b>
215030	3.0	61	33	10	<b>180</b>
215032	3.2	65	36	10	<b>190</b>
215035	3.5	70	39	10	<b>200</b>
215038	3.8	75	43	10	<b>220</b>
215040	4.0	75	43	10	<b>230</b>
215042	4.2	75	43	10	<b>240</b>
215045	4.5	80	47	10	<b>250</b>
215050	5.0	86	52	10	<b>270</b>
215055	5.5	93	57	10	<b>320</b>
215060	6.0	93	57	10	<b>330</b>
215070	7.0	109	69	10	<b>490</b>
215075	7.5	109	69	10	<b>550</b>
215080	8.0	117	75	10	<b>690</b>
215085	8.5	117	75	10	<b>720</b>
215090	9.0	125	81	10	<b>790</b>
215095	9.5	125	81	10	<b>850</b>
215100	10.0	133	87	10	<b>990</b>
215105	10.5	133	87	10	<b>1.250</b>
215110	11.0	142	94	5	<b>1.290</b>
215115	11.5	142	94	5	<b>1.350</b>
215120	12.0	151	101	5	<b>1.550</b>
215130	13.0	151	101	5	<b>1.750</b>

## PUNTO, DIN 338, TIP N, HSS-G - GAMË PROFESIONALE

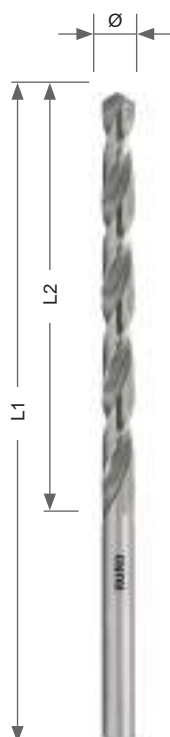

**Profili i kanalit:** Normal  
**Brendia:** Normal  
**Forma:** N, korrjijim frustokonik, mprehje normale

Punto Spirale standarte, e plote dhe e forte, e perbere nga Inoks me performance te larte. Për shkak të formes kryq, kjo punto ka përqëndrim të mirë dhe kërkon më pak forcë në përdorim.



Kodi	Permasa	L1 mm	L2 mm	Paketimi	Cmimi
214010B	1.0	34	12	10	<b>79</b>
214015B	1.5	40	18	10	<b>79</b>
214020B	2.0	49	24	10	<b>79</b>
214025B	2.5	57	30	10	<b>89</b>
214030B	3.0	61	33	10	<b>89</b>
214032B	3.2	65	36	10	<b>99</b>
214033B	3.3	65	36	10	<b>99</b>
214035B	3.5	70	39	10	<b>110</b>
214040B	4.0	75	43	10	<b>115</b>
214042B	4.2	75	43	10	<b>120</b>
214045B	4.5	80	47	10	<b>130</b>
214050B	5.0	86	52	10	<b>140</b>
214055B	5.5	93	57	10	<b>180</b>
214060B	6.0	93	57	10	<b>210</b>
214065B	6.5	101	63	10	<b>240</b>
214070B	7.0	109	69	10	<b>290</b>
214075B	7.5	109	69	10	<b>320</b>
214080B	8.0	117	75	10	<b>370</b>
214085B	8.5	117	75	10	<b>420</b>
214090B	9.0	125	81	10	<b>460</b>
214095B	9.5	125	81	10	<b>490</b>
214100B	10.0	133	87	10	<b>650</b>

## PUNTO, DIN 338, TIP N, HSS - GAMË PROFESIONALE



**Profili i kanalit:** Normal  
**Brendia:** Normal  
**Forma:** N, korrjigim frustokonik, mprehje normale

Punto Spirale standarte, e plote dhe e forte, e perbere nga Inoks me performance te larte. Për shkak të formes kryq, kjo punto ka përqëndrim të mirë dhe kërkon më pak forcë në përdorim.



Kodi	Permasa	L1 mm	L2 mm	Paketimi	Cmimi
215010B	1.0	34	12	10	<b>130</b>
215015B	1.5	40	18	10	<b>135</b>
215020B	2.0	49	24	10	<b>140</b>
215025B	2.5	57	30	10	<b>160</b>
215030B	3.0	61	33	10	<b>170</b>
215032B	3.2	65	36	10	<b>220</b>
215033B	3.3	65	36	10	<b>220</b>
215035B	3.5	70	39	10	<b>220</b>
215040B	4.0	75	43	10	<b>230</b>
215042B	4.2	75	43	10	<b>230</b>
215045B	4.5	80	47	10	<b>240</b>
215050B	5.0	86	52	10	<b>310</b>
215055B	5.5	93	57	10	<b>320</b>
215060B	6.0	93	57	10	<b>390</b>
215065B	6.5	101	63	10	<b>420</b>
215070B	7.0	109	69	10	<b>520</b>
215075B	7.5	109	69	10	<b>550</b>
215080B	8.0	117	75	10	<b>690</b>
215085B	8.5	117	75	10	<b>720</b>
215090B	9.0	125	81	10	<b>790</b>
215095B	9.5	125	81	10	<b>820</b>
215100B	10.0	133	87	10	<b>990</b>

## PUNTO KONIKE TE FREZUARA TE ÇARA PËR MATERIALE METALIKE DHE TUBA - GAMË PROFESIONALE



Kodi	Permasa	L1 mm	L2 mm	Paketimi	Cmimi
252033	3.3	49	11	10	<b>220</b>

## PUNTO KONIKE TE ÇARA PËR MATERIALE METALIKE DHE TUBA

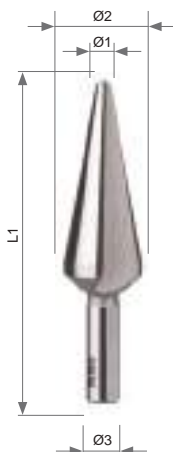

Puntot konike te çara garantojne nje pune te qete dhe nje kapacitet te larte shpimi. Forma konike e majes mundeson largimin e shpejte te mbetjeve.

Madhesia	Ø1-Ø2	L1 mm	Ø3 mm	Paketimi	HSSE Co 5	TIN	Cmimi
					Kodi	Kodi	
1	3.0-14.0	58	6	1	101001	101001T	<b>5.900</b>
2	4.0-20.0	71	8	1	101002	101002T	<b>5.900</b>
3	16.0-30.5	76	9	1	101003	101003T	<b>8.900</b>
8	5.0-31.0	103	9	1	101008	101008T	<b>9.900</b>

## SET ME PUNTO KONIKE TE ÇARA



Madhesia	Ø1-Ø2	L1 mm	Ø3 mm	Paketimi	HSSE Co 5 Kodi	 Cmimi	TiN Kodi	 Cmimi
1	3.0-14.0	58	6	1				
2	4.0-20.0	71	8	1	101020	<b>6.500</b>	101020T	<b>11.900</b>
3	16.0-30.5	76	9	1				

## PUNTO KONIKE TE ÇARA PËR MATERIALE METALIKE DHE TUBA



Për shkak të përmbajtjes së cBN, skajet e prerjes janë shumë precize dhe nuk prodhojnë gropa. Mjetet e rekomanduara për punën e saktë të shpimit dhe qendëzimit.

Madhesia	Ø1-Ø2	L1 mm	Ø3 mm	Paketimi	HSS Kodi	 Cmimi	HSSE Co 5 Kodi	 Cmimi
5	1.5-6.0	45	5.0	1	102107	<b>1.390</b>	102107E	<b>1.450</b>
6	2.0-8.3	50	6.0	1	102111	<b>1.450</b>	102111E	<b>1.750</b>
6	2.5-10.4	50	6.0	1	102114	<b>1.450</b>	102114E	<b>1.750</b>
8	2.8-12.4	56	8.0	1	102116	<b>1.490</b>	102116E	<b>1.990</b>
8	3.2-16.5	60	8.0	1	102119	<b>1.590</b>	102119E	<b>2.490</b>
10	3.5-20.5	63.0	10.0	1			102121E	<b>3.590</b>

## SET ME PUNTO KONIKE TE FREZUARA TE ÇARA



Madhesia	Ø1-Ø2	L1 mm	Ø3 mm	Paketimi	HSS Kodi	 Cmimi	HSSE Co 5 Kodi	 Cmimi
5	1.5-6.0	45	5.0	1				
6	2.0-8.3	50	6.0	1				
6	2.5-10.4	50	6.0	1				
8	2.8-12.4	56	8.0	1	102152	<b>7.500</b>	102152E	<b>8.900</b>
8	3.2-16.5	60	8.0	1				
10	3.5-20.5	63.0	10.0	1				

## PUNTO KONIKE TE FREZUARA TE ÇARA PËR MATERIALE METALIKE DHE TUBA - GAMË PROFESIONALE



**ULTIMATECUT®**

## SET ME PUNTO KONIKE TE FREZUARA TE ÇARA

Madhesia	Ø1-Ø2	L1 mm	Ø3 mm	Paketimi	HSS Kodi	 Cmimi	HSSE Co 5 Kodi	 Cmimi
5	1.5-6.0	45	5.0	1				
6	2.0-8.3	50	6.0	1				
6	2.5-10.4	50	6.0	1				
8	2.8-12.4	56	8.0	1	102152RO	<b>7.900</b>	102790EPRO	<b>14.900</b>
8	3.2-16.5	60	8.0	1				
10	3.5-20.5	63.0	10.0	1				



**PUNTO KONIKE TË ÇARA ME SHKALLË - GAMË PROFESIONALE**



**ULTIMATECUT®**

Puntot konike me shkalle garantojne nje pune te qete dhe pa zhurme. Ato jane optimizuar qe edhe materialet e forta dhe te renda te levizen lehtesisht.

Madhesia	Ø i shpimit	Ø1-Ø2	L1 mm	Ø3 mm	Pa-ke-timi	Kodi	Cmimi
S1	6.0-12.0	6.0-12.0	105	8.0			
M2	6.0-20.0	6.0-20.0	120	10.0	1	101087PRO	<b>18.900</b>
L3	6.0-27.0	6.0-27.0	125	12.0			

**SET ME 14 PUNTO HSS-G TWIST**



Celik me shpejtësi të lartë, i referohet një grupi çeliku veglash të aliazuar me përmbajtje deri në 2,06% karbon dhe deri në 30% përqindje të elementeve aliazhi si tungsteni, molibden, vanadium, kobalt, nikeli dhe titan. Materialet HSS karakterizohen nga fortësi e madhe, rezistencë ndaj konsumit dhe rezistencë ndaj nxehtësisë deri në 600° C. Aksesoret HSS janë më pak të ndjeshme ndaj goditjeve dhe dridhjeve, të cilat ndonjëherë çojnë shpejt në thyerje të materialeve më të forta prerëse.

Kodi	Permasa	Cmimi
259048RO	M3-M12	<b>11.900</b>

**SET ME 15 PUNTO HSS-G TWIST**



Set me 15 punto HSS-g twist përbëhet nga çeliku me shpejtësi të larte. Forcë deri në 800 N/mm<sup>2</sup>,

Kodi	Permasa	Cmimi
259004RO	M3-M12	<b>9.900</b>

**SET ME 19 PUNTO METALI ME MAJE KONIKE**



**ULTIMATECUT®**

Ø 1,0 mm deri në 10,0 mm në rritje prej 0,5 mm

Jetëgjatësi dukshëm më e gjatë e veglave - deri në 5 herë më shumë vrima të mundshme. Kursime kohe deri në 50%. Shpim jashtëzakonisht i shpejtë dhe me kursim të energjisë. Qendërzim perfekt, duke shmangur rrëshqitjen edhe në sipërfaqe të rumbullakëta. Procesi i shpimit i lehtë dhe i qetë, pa bllokim në material. Performancë optimale në makineritë me bateri.

Kodi	Permasa	Cmimi
259214RO	1-10.0 mm	<b>14.900</b>

## A10

- Lehtësisht e levizshme fale reduktimit me 50% te forces magnetike ne momentin qe fiket motorri.
- Lartesi e rregullueshme fale mekanizmit te dyfishte
- Shume i lehte / i thjeshte per tu perdorur
- Forca magnetike: 10.000 N
- Furnizim automatik me ftohes

Kodi 108010A



**Forca shtrënguese magnetike:**  
10,000 N



**Konsumi total i energjisë:**  
1.100 vat



**Shpejtësia e rrotullimit:**  
700 r.p.m



**Lartësia:**  
400,0 - 580,0 mm



**Lift:**  
120,0 / 195,0 mm



**Gjatësia dhe gjerësia:**  
160,0 x 80,0 mm



**Pesha:**  
10.5 kg



**Adaptor:**  
**Weldon:** 19,0 mm (3/4")



**Punto:**  
DIN 338: maksimumi. Ø 13,0 mm



**Gota shpimi:**  
Ø 12,0 - 35,0 mm

109.000



**Punto konike te frezuara:**  
maksimumi Ø 35,0 mm



**Thellesia e shpimit me gote:**  
deri në 110,0 mm



**Tensioni:**  
220 - 240 Volt



**Pershtatja me:**  
Vde, Cee

## RU25

- Lehtësisht e levizshme fale reduktimit me 50% te forces magnetike ne momentin qe fiket motorri.
- Lartesi e rregullueshme fale mekanizmit te dyfishte
- Shume i lehte / i thjeshte per tu perdorur
- Forca magnetike: 16.000 N
- Furnizim automatik me ftohes

Kodi 108025RU



**Forca shtrënguese magnetike:**  
16,000 N



**Konsumi total i energjisë:**  
1.200 vat



**Shpejtësia e rrotullimit:**  
100 - 250 r.p.m



**Lartësia:**  
529 mm



**Lift:**  
120,0 / 195,0 mm



**Gjatësia dhe gjerësia:**  
238,0 x 92,0 mm



**Pesha:**  
16 kg



**Adaptor:**  
**Weldon:** 19,0 mm (3/4")



**Punto:**  
DIN 338: maksimumi. Ø 13,0 mm



**Gota shpimi:**  
Ø 12,0 - 35,0 mm

239.000



**Punto konike te frezuara:**  
maksimumi Ø 55,0 mm



**Thellesia e shpimit me gote:**  
deri në 110,0 mm



**Tensioni:**  
220 - 240 Volt



**Pershtatja me:**  
Vde, Cee

## GOTË SHPIMI PËR TRAPAN MAGNETIK HSS



Kodi	Permasa	L1 mm	L2 mm	Paketimi	Cmimi
108212	12.0 mm	63	30	1	<b>3.500</b>
108214	14.0 mm	63	30	1	<b>3.500</b>
108216	16.0 mm	63	30	1	<b>3.900</b>
108218	18.0 mm	63	30	1	<b>4.800</b>
108220	20.0 mm	63	30	1	<b>4.900</b>
108222	22.0 mm	63	30	1	<b>5.500</b>
108224	24.0 mm	63	30	1	<b>5.900</b>
108226	26.0 mm	63	30	1	<b>6.500</b>
108228	28.0 mm	63	30	1	<b>6.700</b>
108230	30.0 mm	63	30	1	<b>6.800</b>
108232	32.0 mm	63	30	1	<b>6.900</b>

## PUNTO FREZE PER TRAPAN MAGNETIK



Kodi	Permasa	L1 mm	L2 mm	Paketimi	Cmimi
108512	12.0 mm	88	55	1	<b>5.500</b>
108513	13.0 mm	88	55	1	<b>5.900</b>
108514	14.0 mm	88	55	1	<b>6.500</b>
108516	16.0 mm	88	55	1	<b>6.900</b>
108518	18.0 mm	88	55	1	<b>7.200</b>
108520	20.0 mm	88	55	1	<b>7.500</b>
108522	22.0 mm	88	55	1	<b>7.900</b>
108524	24.0 mm	88	55	1	<b>8.900</b>
108526	26.0 mm	88	55	1	<b>8.900</b>
108528	28.0 mm	88	55	1	<b>9.500</b>
108530	30.0 mm	88	55	1	<b>10.900</b>
108532	32.0 mm	88	55	1	<b>11.500</b>
108534	34.0 mm	88	55	1	<b>12.500</b>

## SET ME 7 GOTA SHPIMI PER TRAPAN MAGNETIK + ADAPTOR



Kodi	Permasa	L1 mm	L2 mm	Paketimi	Cmimi
108820	12-22	63	30	1	<b>14.900</b>



## MESHKUJ FILETIMI ME 1 KALIM

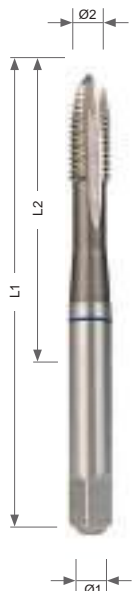

Aplikimi:

- materiale rezistente deri në 900 N/mm<sup>2</sup>
- çelik me aliazh të ulët
- për vrimat e bllokuara
- për filetimi manual

Madhesia	Ø1-Ø2	L1 mm	L2 mm	Paketi- timi	HSS		HSSE Co 5		TiN	
					Kodi	Cmimi	Kodi	Cmimi	Kodi	Cmimi
M3	2.5-2.2	70	22	1	2325030	<b>1.390</b>	2325030E	<b>1.650</b>	2325030T	<b>1.190</b>
M4	3.3-2.8	90	25	1			2325040E	<b>1.790</b>	2325040T	<b>2.500</b>
M5	4.2-3.5	100	28	1			2325050E	<b>1.790</b>	2325050T	<b>2.500</b>
M6	5.0-4.5	110	32	1			2325060E	<b>1.850</b>	2325060T	<b>2.590</b>
M8	6.8-6.0	125	40	1			2325080E	<b>2.150</b>	2325080T	<b>3.350</b>
M10	8.5-7.0	140	45	1			2325100E	<b>2.590</b>	2325100T	<b>3.590</b>
M12	10.2-9.0	180	50	1	2325120	<b>2.450</b>	2325120E	<b>2.690</b>	2325120T	<b>3.990</b>

## MESHKUJ FILETIMI ME 3 KALIME

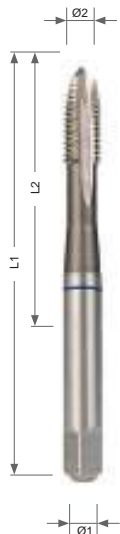

Aplikimi:

- materiale rezistente deri në 900 N/mm<sup>2</sup>
- çelik me aliazh të ulët
- për vrimat e bllokuara
- për filetimi manual



Kodi	Perma- sa	Ø1-Ø2	L1 mm	L2 mm	Paket- imi	Cmimi
230030	M3	2.5-2.2	70	22	3	<b>2.190</b>
230040	M4	3.2-2.8	90	25	3	<b>2.190</b>
230050	M5	4.2-3.5	100	28	3	<b>2.350</b>
230060	M6	5.0-4.5	110	32	3	<b>2.350</b>
230080	M8	6.6-6.0	125	40	3	<b>2.450</b>
230100	M10	8.5-7.0	140	45	3	<b>2.950</b>
230120	M12	10.2-9.0	180	50	3	<b>3.950</b>

## MATRAVIDE FILETIMI M DIN EN 22568

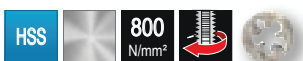

Kodi	Permasa	Ø1	T	Hapi	Paketimi	Cmimi
237030	M3	20	5	0.5	1	<b>1.500</b>
237040	M4	20	5	0.7	1	<b>1.500</b>
237050	M5	20	7	0.8	1	<b>1.500</b>
237060	M6	25	7	1.0	1	<b>1.500</b>
237080	M8	25	9	1.25	1	<b>1.690</b>
237100	M10	30	11	1.50	1	<b>1.990</b>
237120	M12	38	14	1.75	1	<b>2.490</b>

## KRAH PER MESHKUJ FILETIMI DIN 1814

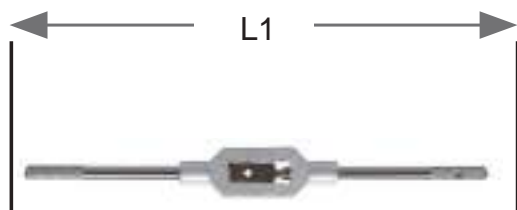

Kodi	Permasa	L1 mm	G	Paketimi	Cmimi
241112	1 1/2	175.0	1/8	1	<b>1.550</b>

## KRAH PER MATRAVIDA FILETIMI DIN 1814

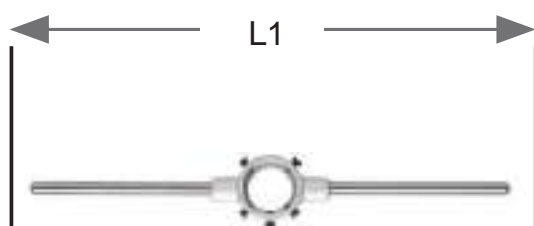

- Ideal per matravidat e filetitimit ne vendet e ngushta
- 5 tensionues te mashkullit te filetitimit
- 2 doreza te heqshme per tu perdorur ne vendet e ngushta



Kodi	L1 mm	Per matravida	Paketimi	Cmimi
242205	175	M3-M4	1	<b>690</b>
242207	175	M4.5-M6	1	<b>790</b>
242259	210	M7-M9	1	<b>890</b>
2423011	260	M12-M14	1	<b>1.290</b>

## KOMPLET FILETIMI 44 COPE



Kodi	Permasa	L1 mm	G	Paketimi	Cmimi
245030	M3-M4				<b>14.900</b>

## KIT PER RIPARIM FILETOSH TE DEMTUARA 86 AKSESORE



Kodi	Permasa	L1 mm	G	Paketimi	Cmimi
244208	M5-M12				<b>14.900</b>



Germany

# 388 CO

## PUNTO METALI COBALT



HSS-CO

### PUNTO METALI HSS-CO / DIN 338

Kodi	Permasa (mm)	Çmimi
B09338E1.00	1,00	<b>45</b>
B09338E1.50	1,50	<b>50</b>
B09338E2.00	2,00	<b>55</b>
B09338E2.50	2,50	<b>90</b>
B09338E3.00	3,00	<b>145</b>
B09338E3.20	3,20	<b>160</b>
B09338E3.50	3,50	<b>170</b>
B09338E3.80	3,80	<b>180</b>
B09338E4.00	4,00	<b>190</b>
B09338E4.20	4,20	<b>200</b>
B09338E4.50	4,50	<b>210</b>
B09338E5.00	5,00	<b>240</b>
B09338E5.20	5,20	<b>280</b>
B09338E5.50	5,50	<b>290</b>
B09338E6.00	6,00	<b>320</b>

Kodi	Permasa (mm)	Çmimi
B09338E6.50	6,50	<b>380</b>
B09338E7.00	7,00	<b>490</b>
B09338E7.50	7,50	<b>550</b>
B09338E8.00	8,00	<b>650</b>
B09338E8.50	8,50	<b>690</b>
B09338E9.00	9,00	<b>750</b>
B09338E9.50	9,50	<b>790</b>
B09338E10.00	10,00	<b>990</b>
B09338E10.50	10,50	<b>1.150</b>
B09338E11.00	11,00	<b>1.200</b>
B09338E11.50	11,50	<b>1.350</b>
B09338E12.00	12,00	<b>1.550</b>
B09338E12.50	12,50	<b>1.390</b>
B09338E13.00	13,00	<b>1.750</b>

# 388 G

## PUNTO METALI HSS-G



HSS-G

Kodi	Permasa (mm)	Çmimi
B09338RG1.00	1,00 mm	<b>20</b>
B09338RG1.20	1,20 mm	<b>25</b>
B09338RG1.50	1,50 mm	<b>25</b>
B09338RG2.00	2,00 mm	<b>30</b>
B09338RG2.50	2,50 mm	<b>35</b>
B09338RG3.00	3,00 mm	<b>40</b>
B09338RG3.20	3,20 mm	<b>45</b>
B09338RG3.50	3,50 mm	<b>50</b>
B09338RG4.00	4,00 mm	<b>55</b>
B09338RG4.50	4,50 mm	<b>60</b>
B09338RG5.00	5,00 mm	<b>70</b>
B09338RG5.50	5,50 mm	<b>75</b>

Kodi	Permasa (mm)	Çmimi
B09338RG6.00	6,00 mm	<b>80</b>
B09338RG6.50	6,50 mm	<b>85</b>
B09338RG7.00	7,00 mm	<b>105</b>
B09338RG7.50	7,50 mm	<b>115</b>
B09338RG8.00	8,00 mm	<b>170</b>
B09338RG8.50	8,50 mm	<b>180</b>
B09338RG9.00	9,00 mm	<b>190</b>
B09338RG9.50	9,50 mm	<b>220</b>
B09338RG10.00	10,00 mm	<b>240</b>
B09338RG11.00	11,00 mm	<b>280</b>
B09338RG12.00	12,00 mm	<b>350</b>



# 340 N



# Germany

## PUNTO METALI TE GJATA



Kodi	Permasa (mm)	Çmimi
B11340G2.00	20 mm	<b>75</b>
B11340G2.50	2.5 mm	<b>80</b>
B11340G3.00	3.0 mm	<b>95</b>
B11340G3.20	3.2 mm	<b>105</b>
B11340G3.50	3.5 mm	<b>110</b>
B11340G4.00	4.0 mm	<b>135</b>
B11340G4.20	4.2 mm	<b>155</b>
B11340G5.00	5.0 mm	<b>175</b>
B11340G5.50	5.5 mm	<b>240</b>
B11340G6.00	6.0 mm	<b>300</b>
B11340G7.00	7.0 mm	<b>400</b>
B11340G7.50	7.5 mm	<b>450</b>
B11340G8.00	8.0 mm	<b>580</b>
B11340G8.20	8.2 mm	<b>590</b>
B11340G8.50	8.5 mm	<b>650</b>
B11340G9.00	9.0 mm	<b>790</b>
B11340G9.50	9.5 mm	<b>890</b>
B11340G10.00	10.0 mm	<b>1000</b>
B11340G11.00	11.0 mm	<b>1050</b>
B11340G11.50	11.5 mm	<b>1150</b>
B11340G12.00	12.0 mm	<b>1350</b>
B11340G12.50	12.5 mm	<b>1390</b>
B11340G13.00	13.0 mm	<b>1550</b>

# 338 N

## PUNTO ME AKS 10/13



PUNTO METALI ME AKS 10/13 MM DIN 338N-HSS

Kodi	Permasa (mm)	Çmimi
B17ABG338N14/13	14 mm	<b>650</b>
B17ABG338N15/13	15 mm	<b>690</b>
B17ABG338N16/13	16 mm	<b>890</b>
B17ABG338N17.50/13	17.5 mm	<b>1.190</b>
B17ABG338N17/13	17 mm	<b>1.150</b>
B17ABG338N18/13	18 mm	<b>1.250</b>



## PUNTO METALI KONIKE

Kodi	Permasa (mm)	Çmimi
B10345N14.00	14,00	<b>1.150</b>
B10345N14.50	14,50	<b>1.150</b>
B10345N15.00	15,00	<b>1.150</b>
B10345N16.00	16,00	<b>1.200</b>
B10345N16.50	16,50	<b>1.350</b>
B10345N17.00	17,00	<b>1.450</b>
B10345N18.00	18,00	<b>1.490</b>
B10345N18.50	18,50	<b>1.550</b>
B10345N19.00	19,00	<b>1.690</b>
B10345N20.00	20,00	<b>1.950</b>
B10345N20.50	20,50	<b>1.990</b>
B10345N22.00	22,00	<b>2.250</b>
B10345N22.50	22,50	<b>2.250</b>
B10345N23.00	23,00	<b>2.390</b>
B10345N24.00	24,00	<b>2.990</b>
B10345N24.50	24,50	<b>2.990</b>

Kodi	Permasa (mm)	Çmimi
B10345N25.00	25,00	<b>2.990</b>
B10345N25.50	25,50	<b>2.990</b>
B10345N26.00	26,00	<b>3.250</b>
B10345N26.50	26,50	<b>3.990</b>
B10345N27.00	27,00	<b>3.990</b>
B10345N27.50	27,50	<b>3.990</b>
B10345N28.00	28,00	<b>4.250</b>
B10345N28.50	28,50	<b>4.250</b>
B10345N29.00	29,00	<b>4.290</b>
B10345N29.50	29,50	<b>4.350</b>
B10345N30.00	30,00	<b>4.390</b>
B10345N30.50	30,50	<b>4.390</b>
B10345N31.00	31,00	<b>4.450</b>
B10345N31.50	31,50	<b>4.490</b>
B10345N32.00	32,00 MK 4	<b>4.590</b>
B10345N33.00	33,00	<b>4.900</b>
B10345N33.25	33,25	<b>5.500</b>

**GOTE DIAMANTI PER QERAMIKE**



Kodi	Dimensioni	Çmimi
BHT4051	Φ5mm	<b>1.490</b>
BHT4052	Φ6mm	<b>1.490</b>
BHT4053	Φ8mm	<b>1.490</b>
BHT4054	Φ10mm	<b>1.490</b>
BHT4055	Φ12mm	<b>1.490</b>
BHT4056	Φ14mm	<b>1.490</b>
BHT4057	Φ16mm	<b>1.490</b>
BHT4058	Φ20mm	<b>1.490</b>
BHT4059	Φ22mm	<b>1.490</b>
BHT4060	Φ30mm	<b>1.790</b>
BHT4061	Φ32mm	<b>1.900</b>
BHT4062	Φ35mm	<b>2.150</b>
BHT4063	Φ40mm	<b>2.450</b>
BHT4064	Φ45mm	<b>2.590</b>
BHT4065	Φ60mm	<b>3.590</b>
BHT4066	Φ70mm	<b>4.190</b>

**GOTE BETONI ME PUNTO DHE ADAPTOR SDS-PLUS**



Kodi	Diametri	Çmimi
BHT4081	115 mm	<b>3.990</b>

**MANDRINO VETESH-TRENGUESE**



Kodi	Diametri	Çmimi
BKC2300	13 mm	<b>2.190</b>

**LAMA PER SHARRE SHIRIT**



Kodi	Diametri	Çmimi
49081505	1400x8x0,65	<b>1.890</b>

**ADAPTOR SDS-MAX**



Kodi	Diametri	Çmimi
BHT4084	22x450 mm	<b>1.690</b>

**MANDRINO SDS-PLUS**



Kodi	Diametri	Çmimi
BKC2400	2-13 mm	<b>990</b>

**SET ME 3 DALTA SDS-MAX**

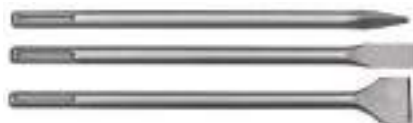

Kodi	Diametri	Çmimi
49190103	400 mm	<b>1.790</b>

**KEND PER MAJA KAÇAVIDE HEXAGON 1/4"**



Kodi	Diametri	Çmimi
BKC2200	1/4"	<b>1.200</b>

**SHUFER PER PERZJERESE KOLLI**



Kodi	Diametri	Çmimi
49497215	100x600 mm	<b>1.490</b>
49497635	M14 600mm	<b>1.490</b>
49497625	M14 600mm	<b>1.550</b>

**SET ME 2 SHUFERA PER PERZJERESE KOLLI**



Kodi	Diametri	Çmimi
494.977.95	550x120	<b>2.250</b>

**PUNTO QERAMIKE**

Kodi	Dimensioni	Çmimi
05560	6 mm	<b>199</b>
05580	8 mm	<b>220</b>
05600	10 mm	<b>270</b>

**PUNTO QERAMIKE ME KAPJE HEXAGON**

Kodi	Dimensioni	Çmimi
21705	10 mm	<b>350</b>

**SET ME 5 PUNTO QERAMIKE HEXAGON**

Kodi	Dimensioni	Çmimi
21709	4-10 mm	<b>890</b>

**SET ME 6 KOKA ZMERILIMI BRONZI**

Kodi	Sasia	Çmimi
06990	6 cope	<b>290</b>

**PUNTO METALI KONIKE TITAN**

Kodi	Dimensioni	Çmimi
22612	4 - 32 mm	<b>1.100</b>

**PUNTO METALI KONIKE TITAN**

Kodi	Dimensioni	Çmimi
22613	6 - 39 mm	<b>1.900</b>

**ADAPTOR SDS-PLUS PER MAJA 1/4"**

Kodi	Dimensioni	Çmimi
23460	1/4"	<b>150</b>

**DALTE SDS-PLUS ME MAJE TE SHESHTE**

Kodi	Dimensioni	Çmimi
23594	60 mm	<b>750</b>

**SET ME 11 GOTA SHPIMI + ADAPTOR**

Kodi	Dimensioni	Çmimi
22570	19-64 mm	<b>750</b>

**SET ME 11 GOTA SHPIMI + ADAPTOR**

Kodi	Dimensioni	Çmimi
22572	38 - 127 mm	<b>990</b>

**SET ME 5 KOKA ZMERILIMI DIAMANTI**

Kodi	Dimensioni	Çmimi
25450	25/22/11/25/30	<b>399</b>

**SET ME 6 PUNTO DIAMANTI**

Kodi	Dimensioni	Çmimi
25405	40 mm	<b>390</b>





**LAMA SHARRA VERTIKALE**



**MADE IN GERMANY**

**CV** Chrom Vanadium + **MS** e frezuar, me kend milled, set = Prerje standarte ne dru Standard cut in wood

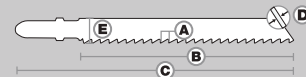

**M.P.S.**

Per tu perdorur si

**3106**

**Set me 5-cope lame sharre vertikale 100 x 75 x 3 mm per dru dhe melamine Classic Line**

Metabo 23632 A = 3 mm · 8 t.p.i. B = 75 mm · 2.953 C = 100 mm · 3.937 D = 1,25 mm · 0.049 E = 8 mm · 0.315

**Classic Line**

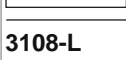
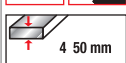

**490**

Paketimi 5 cope

Dru i bute / dru ndertimi, Melamine, MDF, Prerje e shpejte, Prerje e drejte, Prerje e veshtire

**3108-L**

**Set me 5-cope lame sharre vertikale 132 x 110 x 2 mm per dru dhe melamine Classic Line**

A = 2 mm · 12 t.p.i. B = 110 mm · 4.331 C = 132 mm · 5.179 D = 1,25 mm · 0.049 E = 8 mm · 0.315

**Classic Line**

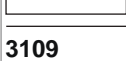
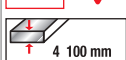

**590**

Paketimi 5 cope

Dru i bute / dru ndertimi, Kompesate, Melamine, MDF, Prerje e drejte, Prerje e veshtire, Shume e gjate

**3109**

**Set me 5-cope lame sharre vertikale 85 x 60 x 2 mm per dru dhe melamine Classic Line**

Metabo 23646 A = 2 mm · 12 t.p.i. B = 50 mm · 1.969 C = 75 mm · 2.953 D = 1,25 mm · 0.049 E = 8 mm · 0.315

**Classic Line**

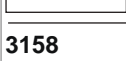
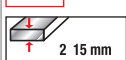

**490**

Paketimi 5 cope

Dru i bute / dru ndertimi, Kompesate, Melamine, MDF, Prerje me hark

**3158**

**Set me 5-cope lame sharre vertikale 250 x 230 x 3 mm per dru dhe melamine Profi Line**

A = 2,5 mm · 10 t.p.i. B = 220 mm · 8.661 C = 250 mm · 9.843 D = 1,25 mm · 0.049 E = 8 mm · 0.315

**Profi Line**

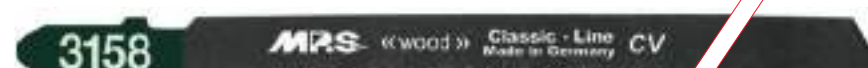
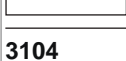
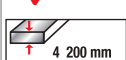
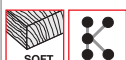

**1.590**

Paketimi 5 cope

Dru i bute / dru ndertimi, Plastike, Prerje e drejte, Shume e gjate

**3104**

**Set me 5-cope lame sharre vertikale 100 x 75 x 4 mm per dru dhe melamine Profi Line**

Metabo 23633 A = 4 mm · 6 t.p.i. B = 75 mm · 2.953 C = 100 mm · 3.937 D = 1,25 mm · 0.049 E = 8 mm · 0.315

**Profi Line**

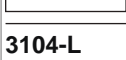
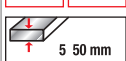

**650**

Paketimi 5 cope

Dru i bute / dru ndertimi, Kompesate, Melamine, MDF, Suprine kuzhine, Prerje e drejte, Prerje e shpejte

**3104-L**

**Set me 5-cope lame sharre vertikale 130 x 110 x 4 mm per dru dhe melamine Profi Line**

Metabo 23678 A = 4 mm · 6 t.p.i. B = 110 mm · 4.331 C = 132 mm · 5.179 D = 1,25 mm · 0.057 E = 8 mm · 0.315

**Profi Line**

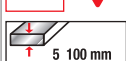

**750**

Paketimi 5 cope

Dru i bute / dru ndertimi, Melamine, MDF, Prerje e shpejte, Shume e gjate

**MADE IN GERMANY**

**CV** Chrom Vanadium + **CT** e zmeriluar kryq,  
e temperuar  
crossground, tapered

= Prerje e paster  
Very clean cut

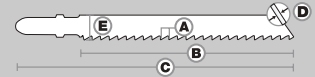

**M.P.S.**

Per tu perdorur si

**3101**

**Set me 5-cope lame sharre vertikale 100 x 75 x 2.5 mm per dru dhe melamine Profi Line**

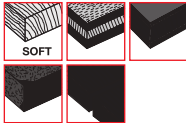

Metabo 23634 A = 2,5 mm · 10 t.p.i. B = 75 mm · 2.953 C = 100 mm · 3.937 D = 1,45 mm · 0.057 E = 8 mm · 0.315

**Profi Line**



**690**  
Paketimi 5 cope



Dru i bute / dru ndertimi, Kompesate, Melamine, MDF, Prerje e paster, Prerje e drejte, Prerje e veshtire

**3101-L**

**Set me 5-cope lame sharre vertikale 130 x 110 x 2.5 mm per dru dhe melamine Profi Line**



A = 2,5 mm · 10 t.p.i. B = 110 mm · 4.331 C = 132 mm · 5.197 D = 1,45 mm · 0.057 E = 8 mm · 0.315

**Profi Line**

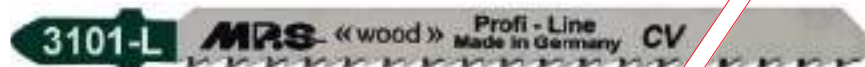

**890**  
Paketimi 5 cope



Dru i bute / dru ndertimi, Kompesate, Melamine, MDF, Prerje e paster, Prerje e drejte, Shume e gjate

**3105**

**Set me 5-cope lame sharre vertikale 100 x 75 x 4 mm per dru dhe melamine Profi Line**

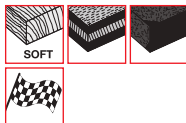

Metabo 23649 A = 4 mm · 6 t.p.i. B = 75 mm · 2.953 C = 100 mm · 3.937 D = 1,25 mm · 0.049 E = 8 mm · 0.315

**Profi Line**



**650**  
Paketimi 5 cope



Dru i bute / dru ndertimi, Kompesate, Melamine, MDF, Prerje e shpejte, Prerje me hark

**3104-XL**

**Set me 5-cope lame sharre vertikale 150 x 130 x 4 mm per dru dhe melamine Profi Line**

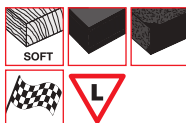

A = 4 mm · 6 t.p.i. B = 130 mm · 5.118 C = 150 mm · 5.906 D = 1,25 mm · 0.049 E = 8 mm · 0.315

**Profi Line**

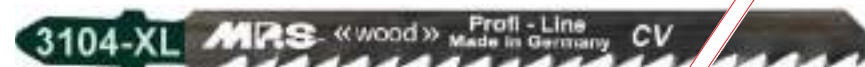

**890**  
Paketimi 5 cope

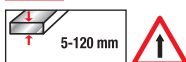

Dru i bute / dru ndertimi, Melamine, MDF, Prerje e shpejte, Prerje e drejte, Shume e gjate

**3104-XLS**

**Set me 5-cope lame sharre vertikale 170 x 145 x 4 mm per dru dhe melamine Profi Line**



A = 4 mm · 6 t.p.i. B = 125 mm C = 150 mm · 5.905 D = 1,7 mm · 0.067 E = 8 mm · 0.315

**Profi Line**



**1.290**  
Paketimi 5 cope



Dru i bute / dru ndertimi, Melamine, MDF, Prerje e shpejte, Prerje e drejte, Shume e gjate, Prerje Precize

**3102**

**Set me 5-cope lame sharre vertikale 100 x 75 x 2.5 mm per dru dhe melamine Profi Line me dhemb ne te kundert**

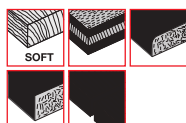

Metabo 23650 A = 2,5 mm · 10 t.p.i. B = 75 mm · 2.953 C = 100 mm · 3.937 D = 1,45 mm · 0.057 E = 8 mm · 0.315

**Profi Line**

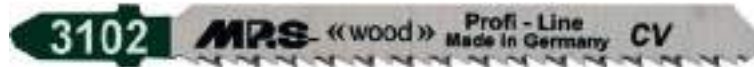

**690**  
Paketimi 5 cope



Dru i bute / dru ndertimi, Kompesate, Laminat, Suprine kuzhine, Prerje e paster, Prerje e drejte, Pa ashkla

**3103**

**Set me 5-cope lame sharre vertikale 100 x 75 x 4 mm per dru dhe melamine Profi Line**

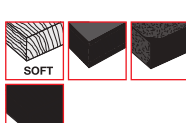

Metabo 23635 A = 4 mm · 6 t.p.i. B = 75 mm · 2.953 C = 100 mm · 3.937 D = 1,45 mm · 0.057 E = 8 mm · 0.315

**Profi Line**

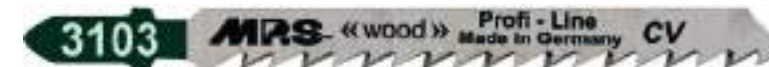

**650**  
Paketimi 5 cope



Dru i bute / dru ndertimi, Melamine, MDF, Prerje e shpejte, Prerje e drejte



**LAMA SHARRA VERTIKALE**



**MADE IN GERMANY**

**CV** Chrom Vanadium + **MS** e frezuar, me kend milled, set = Prerje standarte ne dru Standard cut in wood

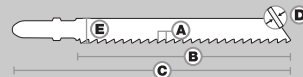

**M.P.S.**

Per tu perdorur si

**31035**

**Set me 5-cope lame sharre vertikale 115 x 95 x 4 mm per dru dhe melamine Profi Line**

Metabo 23654 A = 4 mm · 6 t.p.i. B = 95 mm · 3.740 C = 115 mm · 4.528 D = 1,45 mm · 0.057 E = 8 mm · 0.315

**Profi Line**

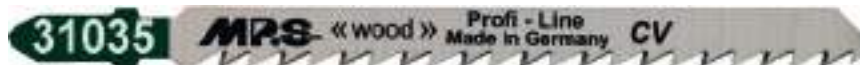
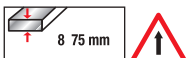
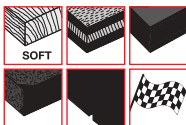

**790**  
Paketimi 5 cope

Dru i bute / dru ndertimi, Komposate, Melamine, MDF, Suprine kuzhine, Prerje e shpejte, Prerje e drejte

**3145**

**Set me 5-cope lame sharre vertikale 100 x 75 x 3 mm per dru dhe melamine Profi Line**

A = 3 mm · 8 t.p.i. B = 75 mm · 2.953 C = 100 mm · 3.937 D = 1,45 mm · 0.057 E = 8 mm · 0.315

**Profi Line**

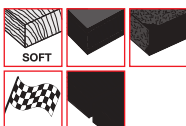

**690**  
Paketimi 5 cope

Dru i bute / dru ndertimi, Komposate, Melamine, MDF, Prerje e paster, Prerje e shpejte, Prerje e drejte

**3160**

**Set me 5-cope lame sharre vertikale 100 x 75 x 1.5 mm per dru dhe melamine Profi Line**

A = 2 mm · 12 t.p.i. B = 75 mm · 2.953 C = 100 mm · 3.937 D = 1,45 mm · 0.057 E = 8 mm · 0.315

**Profi Line**

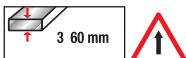
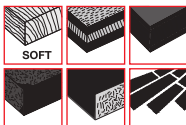

**690**  
Paketimi 5 cope

Dru i bute / dru ndertimi, Komposate, Melamine, MDF, Pllake laminati, Laminat, Prerje e paster

**3165**

**Set me 5-cope lame sharre vertikale 132 x 110 x 1.5 mm per dru dhe melamine Profi Line**

A = 2 mm · 12 t.p.i. B = 110 mm · 4.331 C = 132 mm · 5.197 D = 1,45 mm · 0.057 E = 8 mm · 0.315

**Profi Line**

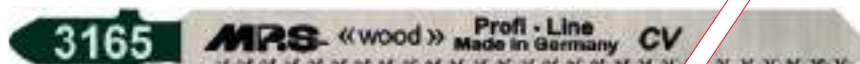
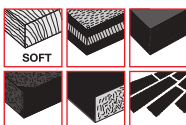

**890**  
Paketimi 5 cope

Dru i bute / dru ndertimi, Komposate, Melamine, MDF, Pllake laminati, Laminat, Prerje e paster, Prerje e drejte, Shume e gjate

**3180**

**Set me 5-cope lame sharre vertikale 115 x 90 x 2.8 mm per dru dhe melamine Profi Line**

Metabo 23675 A = 2,5 3,2 mm · 8 10 t.p.i. B = 90 mm · 3.543 C = 115 mm · 4.528 D = 1,45 mm · 0.057 E = 8 mm · 0.315

**Profi Line**

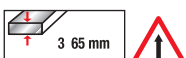
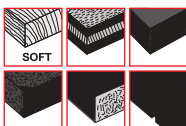

**990**  
Paketimi 5 cope

Dru i bute / dru ndertimi, Komposate, Melamine, MDF, Pllake laminati, Prerje e drejte ne varesi te trashesise te materialit

**3113**

**Set me 5-cop lame sharre vertikale 75 x 50 x 2 mm per metal Classic Line**

Metabo 23638 A = 2 mm · 12 t.p.i. B = 50 mm · 1.969 C = 75 mm · 2.953 D = 1,00 mm · 0.039 E = 8,00 mm · 0.315

**Classic Line**

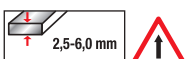

**790**  
Paketimi 5 cope

Flete celiku, Prerje e drejte

## LAMA SHARRA VERTIKALE



MADE IN GERMANY

**CV** Chrom Vanadium + **CT** e zmeriluar kryq, e temperuar  
crossground, tapered

= Prerje e pastër  
Very clean cut

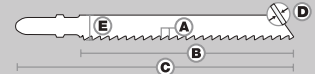

M.P.S.

Per tu perdorur si

**3113**

**Set me 5-cop lame sharre vertikale 75 x 50 x 2 mm per metal Classic Line**

Metabo 23638 A = 2 mm · 12 t.p.i. B = 50 mm · 1.969 C = 75 mm · 2.953 D = 1,00 mm · 0.039 E = 8,00 mm · 0.315

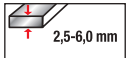

Flete celiku, Prerje e drejte

**Classic Line**

**790**  
Paketimi 5 cope

**3114**

**Set me 5-cope lame sharre vertikale 132 x 110 x 1.2 mm per metal Classic Line**

Metabo 23629 A = 1,2 mm · 21 t.p.i. B = 110 mm · 4.331 C = 132 mm · 5.197 D = 1,15 mm · 0.045 E = 8,00 mm · 0.315

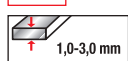

Flete celiku, Metale jo ferroje/Alumin, Tuba celiku, Profile, Prerje e drejte

**Classic Line**

**990**  
Paketimi 5 cope

**3119**

**Set me 5-cope lame sharre vertikale 100 x 75 x 3 mm per metal Classic Line**

Metabo 23648 A = 3 mm · 8 t.p.i. B = 75 mm · 2.953 C = 100 mm · 3.937 D = 1,15 mm · 0.045 E = 8,00 mm · 0.315

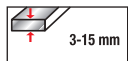

Flete celiku, Metale jo ferroje/Alumin, Tuba celiku, Profile, Prerje me hark

**Classic Line**

**850**  
Paketimi 5 cope

**31135-F**

**Set me 5-cope lame sharre vertikale 100 x 75 x 2 mm per metal dhe alumin Profi Top Line**

A = 2 mm · 12 t.p.i. B = 75 mm · 2.953 C = 100 mm · 3.937 D = 1,00 mm · 0.039 E = 8,00 mm · 0.315

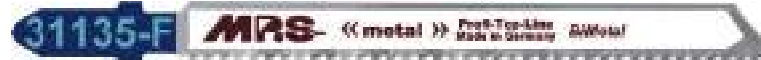
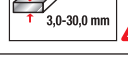

Dru/Dru me gozhde, Inox, Metal/Celik, Metale jo ferroje/Alumin, Prerje e drejte

**Profi Top Line**

**950**  
Paketimi 5 cope

**3150-F**

**Set me 5-cope lame sharre vertikale 132 x 110 x 2.5 mm per metal dhe dru Profi Top Line**

A = 1,8-2,5 mm · 10-14 t.p.i. B = 110 mm · 4.331 C = 132 mm · 5.197 D = 1,27 mm · 0.050 E = 8 mm · 0.315

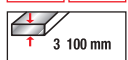
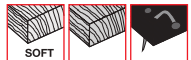

Dru i bute/Dru ndertimi, Inox, Metale jo ferroje/Alumin, Prerje e drejte ne varesi te trashesise se materialit

**Profi Top Line**

**1.490**  
Paketimi 5 cope

**3120-2**

**Set me 5-cope lame sharre vertikale 100 mm per dru dhe metal**

A = 1,8-2,5 mm · 10-14 t.p.i. B = 110 mm · 4.331 C = 132 mm · 5.197 D = 1,27 mm · 0.050 E = 8 mm · 0.315

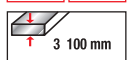
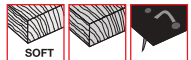

Dru i bute/Dru ndertimi, Inox, Metale jo ferroje/Alumin, Prerje e drejte ne varesi te trashesise se materialit

**Profi Top Line**

**790**  
Paketimi 2 cope

**3122-1**

**Lame sharre vertikale 1-cope 85 x 60 mm per qeramike**

Metabo 23657 A = KORN 30 mm · GRIT 30 t.p.i. B = 50 mm · 1.969 C = 75 mm · 2.953 D = 1,00 mm · 0.039 E = 8,00 mm · 0.315

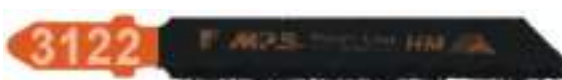
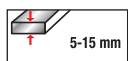

**390**  
Paketimi 1 cope



**Perdorim i gjithanshem  
per te gjithe llojet e druve**

**4035**

**Set me 5-cope lama sharre horizontale per dru 5-cope, per sharra horizontale 150 mm**



A = 4,2 mm - 6 t.p.i. B = 130 mm - 5.118" C = 150 mm - 5.906" D = 1,20 mm - 0.047" E = 19,00 mm - 0.748"



**990**

Paketimi 5 cope



Dru i bute / dru ndertimi, Kompesate, MDF, Plastike

**4037**

**Set me 5-cope lame sharre horizontale 230 x 210 x 4.2 mm per dru, melamine dhe plastik**



A = 4,2 mm - 6 t.p.i. B = 210 mm - 8.268" C = 230 mm - 9.055" D = 1,20 mm - 0.047" E = 19,00 mm - 0.748"



**1.490**

Paketimi 5 cope

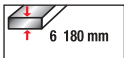

Dru i bute / dru ndertimi, Kompesate, MDF, Plastike

**4046**

**Set me 5-cope lame sharre horizontale 200 x 180 x 4.2 mm per dru, melamine dhe plastik**



A = 2,5-4,2 mm - 8-10 t.p.i. B = 180 mm - 7.087" C = 200 mm - 7.874" D = 1,20 mm - 0.047" E = 19,00 mm - 0.748"



**3.200**

Paketimi 5 cope



Dru i bute / dru ndertimi, Trungje pemesh, Dru zjarri, Shpejtesi prerje e larte

**4045**

**Set me 5-cope lame sharre horizontale 230 x 210 x 2.5 mm per dru dhe melamine**



A = 2,5 mm - 10 t.p.i. B = 210 mm - 8.268" C = 230 mm - 9.055" D = 1,20 mm - 0.047" E = 19,00 mm - 0.748"



**4.900**

Paketimi 5 cope



Kompesate, Multiplex, Dru i ngjitur, MDF, Laminat prerje shume e paster

**4052**

**Set me 5-cope lame sharre horizontale 240 x 210 x 6.5 mm per dru dhe melamine**



Metabo 31139 A = 5-6,5 mm - 4-5 t.p.i. B = 210 mm - 8.268" C = 230 mm - 9.055" D = 1,20 mm - 0.047" E = 19,00 mm - 0.748"



**1.650**

Paketimi 5 cope

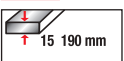

Dru i bute / dru ndertimi, Trungje pemesh, Dru zjarri, Shpejtesi prerje e larte

**4401**

**Set me 5-cope lame sharre horizontale 150 x 130 x 1.4 mm per metal dhe alumin**



Metabo 31132  
Flex 200735

A = 1,4 mm - 18 t.p.i. B = 130 mm - 5.118" C = 150 mm - 5.906" D = 0,90 mm - 0.035" E = 19,00 mm - 0.748"



**1.490**

Paketimi 5 cope

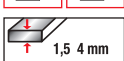



## LAMA SHARRA HORIZONTALE



CV

Chrom Vanadium + MS

e frezuar me kend  
milled, set

Perje standarte  
ne dru/metal  
Standard cut in wood

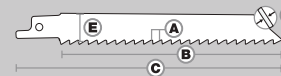

MPS

Per tu perdorur si

4402

### Set me 5-cope lame sharre horizontale 200 x 180 x 1.4 mm per metal dhe alumin

A = 1,4 mm · 18 t.p.i. B = 180 mm · 7.087 C = 200 mm · 7.874 D = 0,90 mm · 0.035 E = 19,00 mm · 0.748

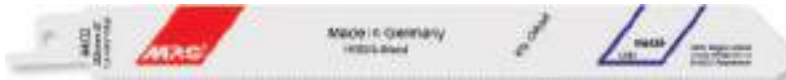
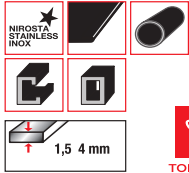

**1.890**  
Paketimi 5 cope

Inox, Metal/Celik, Pllaka celiku, Tuba celiku, Profile

4405

### Set me 5-cope lame sharre horizontale 150 x 130 x 1.0 mm per metale te holla dhe alumin

Metabo 31129  
Flex 200743

A = 1 mm · 25 t.p.i. B = 130 mm · 5.118 C = 150 mm · 5.906 D = 0,90 mm · 0.035 E = 19,00 mm · 0.748



**1.590**  
Paketimi 5 cope

Metal/Celik, Pllaka celiku, Tuba celiku, Profile

4407

### Set me 5-cope lame sharre horizontale 230 x 210 x 1.0 mm per metale te holla dhe alumin

A = 1 mm · 25 t.p.i. B = 210 mm · 8.268 C = 230 mm · 9.055 D = 0,90 mm · 0.035 E = 19,00 mm · 0.748



**2.190**  
Paketimi 5 cope

Metal/Celik, Pllaka celiku, Tuba celiku, Profile

### Set me 5-cope lame sharre horizontale 225 x 205 x 1.8 mm per Inox dhe metale te tjera jo ferroze

4414

A = 2,5 mm · 10 t.p.i. B = 205 mm · 8.071 C = 225 mm · 8.858 D = 0,90 mm · 0.035 E = 25,40 mm · 1.000



**2.290**  
Paketimi 5 cope

Metal/Celik, Inox, Pllaka celiku, Tuba celiku, Profile, Kende precize

4416

### Set me 5-cope lame sharre horizontale 230 x 210 x 1.8 mm per Inox dhe metale te tjera jo ferroze

A = 1,8 mm · 14 t.p.i. B = 210 mm · 8.268 C = 230 mm · 9.055 D = 0,90 mm · 0.035 E = 19,00 mm · 0.748

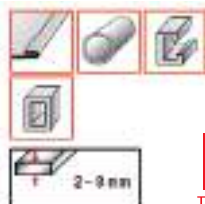

**2.390**  
Paketimi 5 cope

Metal/Celik, Inox, Pllaka celiku, Tuba celiku, Profile

4420

### Set me 5-cope lame sharre horizontale 300 x 280 x 1.4 mm per Inox dhe metale te tjera jo ferroze

A = 1,4 mm · 18 t.p.i. B = 280 mm · 11.024 C = 300 mm · 11.811 D = 0,90 mm · 0.035 E = 19,00 mm · 0.748

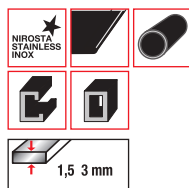

**2.790**  
Paketimi 5 cope

Metal/Celik, Inox, Pllaka celiku, Tuba celiku, Profile



**LAMA SHARRA HORIZONTALE**

**CV** Chrom Vanadium + **MS** e frezuar me kend = Prerje standarte ne dru/metal  
milled, set Standard cut in wood

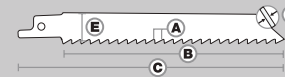

Per tu perdorur si

**4422**

**Set me 5-cope lame sharre horizontale 300 x 280 x 1.8 mm per Inox dhe metale te tjera jo ferroze**

Matsho 31134 A = 1,8 mm · 14 t.p.i. B = 280 mm · 11,024" C = 300 mm · 11,811" D = 0,90 mm · 0,035" E = 19,00 mm · 0,748"



Metal/Celik, Inox, Pllaka celiku, Tuba celiku, Profile



**2.890**  
Paketimi 5 cope

**Set me 5-cop lame sharre horizontale 230 x 210 x 1.4 mm per Inox dhe metale te tjera jo ferroze**

**4429**

A = 1,4-1,8 mm · 14-18 t.p.i. B = 210 mm · 8,267" C = 230 mm · 9,055" D = 0,90 mm · 0,035" E = 19,00 mm · 0,748"

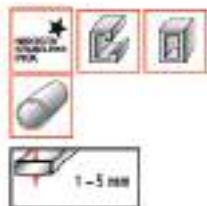

Metal/Celik, Inox, Pllaka celiku, Tuba celiku, Profile



**1.950**  
Paketimi 5 cope

**BIM** Bimetal + **MS** e frezuar me kend = Game e gjere aplikimesh, qendrueshmeri e larte, jetegjatesi sherbimi  
Bimetal milled, set Universal application range, high endurance, long life span

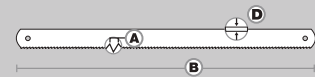

Per tu perdorur si

**Lame per sharre metali 300 x 1.2 mm me 8% Cobalt e bardhe**

**6620-20/24**

A = 1-1,2 mm · 20/24 t.p.i. B = 300 mm · 12 D = 0,65 mm · 1/32



**VARIQZAHN**



**220**  
Paketimi 1 cope

**Lame per sharre metali 300 x 1.0 mm e bardhe**

**6620-24**

A = 1 mm · 24 t.p.i. B = 300 mm · 12 D = 0,65 mm · 1/32



Lama sharre HSS-BI-Metal, Per te gjitha llojet e metaleve, Rezistent ndaj thyerjeve,



**199**  
Paketimi 1 cope

**Lame per sharre metali 300 x 1.0 mm blu**

**6605-24**

A = 1 mm · 24 t.p.i. B = 300 mm · 12 D = 0,65 mm · 1/32



**110**  
Paketimi 1 cope

**6605-24**

Lama sharre per prerjen e metalit, prodhuar nga celik karboni, per materiale standarte dhe jo ferroze



## ADAPTOR + GOTE ME VIDIO PER INOX

- çeliku (V2A & V4A) - çeliku i derdhur
- metali me ngjyra, metali i lehtë
- plastika - tekstile të blinduara
- plasterboard, bord ndërtimi i lehtë - dru



Durchmesser  
Diameter



Durchmesser  
Diameter



M.P.S.

mm

mm

1. 1/16" max.

mm

mm

1. 1/16" max.

Kodi	mm	Cmimi
8016MPS	16	<b>6.500</b>
8020	20	<b>5.900</b>
8022	22	<b>5.900</b>
8025	25	<b>6.500</b>
8030	30	<b>7.500</b>
8035MPS	35	<b>7.900</b>
8040	40	<b>8.500</b>
8045	45	<b>9.500</b>
8050	50	<b>9.900</b>

Kodi	mm	Cmimi
8055	55	<b>11.500</b>
8060MPS	60	<b>12.900</b>
8065	65	<b>13.500</b>
8070	70	<b>14.900</b>
8075MPS	75	<b>15.900</b>
8080	80	<b>19.900</b>
8085	85	<b>22.900</b>
8100	100	<b>24.900</b>
8125	125	<b>29.900</b>

### Adaptor per gota Bi-metali 14-30 mm me kapje Trapani

**950**

5503



11,0

$\frac{7}{16}$



14 30

$\frac{9}{16}$  1  $\frac{3}{16}$

### Adaptor per gota Bi-metali 32-152 mm me kapje Trapani

**1.650**

5505



11,0

$\frac{7}{16}$



32 152

1  $\frac{1}{4}$  6

### Adaptor per gota Bi-metali 14-30 mm me kapje SDS-Plus

**1.490**

5507



SDS



14 30

$\frac{9}{16}$  1  $\frac{3}{16}$

### Adaptor per gota Bi-metali 32-152 mm me kapje SDS-Plus

**2.750**

5508



SDS



32 152

1  $\frac{1}{4}$  6



**KOMPLET ME GOTA BI-METALI**

6560



**SET ME GOTA BIMETAL M24**

Perman:

Ø mm: 19,22,29,38,44,57

Ø inch: 3/4,7/8,1 1/8, 1 1/2, 1 3/4,  
2 1/4

Adaptori: 5503/5505



11.900



Gotat tona të dyfishta bimetale janë me të vërtetë shumëfunktionale: Per dru, metale, plastikë, madje edhe çelik. Këto gota janë në gjendje të bëjnë të gjitha punët. Dhëmbët vario bluar në skajin HSS është krijuar për tu përdorur në mënyrë universale në dru dhe metal.



**Gote HSS-Bi-Metal**

Kodi	mm	Cmimi	Kodi	mm	Cmimi
5016	16	<b>750</b>	5070	70	<b>1.990</b>
5020	20	<b>790</b>	5076	76	<b>2.250</b>
5022	22	<b>850</b>	5079	79	<b>2.290</b>
5025	25	<b>850</b>	5083	83	<b>2.390</b>
5030	30	<b>890</b>	5086	86	<b>2.590</b>
5032	32	<b>990</b>	5092	92	<b>2.690</b>
5035	35	<b>1.090</b>	5095	95	<b>2.790</b>
5038	38	<b>1.150</b>	5100	100	<b>2.950</b>
5040	40	<b>1.190</b>	5105	105	<b>3.090</b>
5043	43	<b>1.250</b>	5111	111	<b>3.450</b>
5044	44	<b>1.290</b>	5127	127	<b>3.990</b>
5045	45	<b>1.350</b>	5133	133	<b>4.590</b>
5050MPS	50	<b>1.390</b>	5146	146	<b>4.790</b>
5052	52	<b>1.490</b>	5152	152	<b>5.590</b>
5055	55	<b>1.690</b>	5168	168	<b>6.590</b>
5060	60	<b>1.790</b>	5190	190	<b>8.590</b>
5065MPS	65	<b>1.890</b>	5200	200	<b>9.990</b>
5068	68	<b>1.990</b>	5210	210	<b>9.500</b>

### GOTA BI-METAL, M42

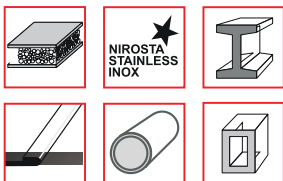

Komplet me 6 gota HSS Bi-metal  
me 8% Cobalt 19,22,29,38,44,57 mm

Te prodhuara nga Bi-Metali M42 keto gota jane profesioniste ne prerjen e metalit. Derdhja prej aliazhi alumini me permbajtje 8% Cobal per rezistence me te larte ndaj temperatures dhe prerje me te mire.



Kodi	mm	Cmimi
6014	14	<b>990</b>
6016	16	<b>1.050</b>
6020	20	<b>1.150</b>
6025	25	<b>1.190</b>
6030	30	<b>1.250</b>
6032	32	<b>1.290</b>
6035	35	<b>1.390</b>
6040	40	<b>1.550</b>
6044	44	<b>1.650</b>
6050	50	<b>1.950</b>

Kodi	mm	Cmimi
6055	55	<b>1.990</b>
6060	60	<b>2.090</b>
6065	65	<b>2.200</b>
6070	70	<b>2.390</b>
6075	75	<b>2.550</b>
6079	79	<b>2.690</b>
6083	83	<b>2.790</b>
6086	86	<b>2.850</b>
6095	95	<b>3.090</b>
6100	100	<b>3.190</b>
6105	105	<b>3.290</b>

### Gote diamanti per pllaka porcelani me kapje per vidiator

Kodi	mm	Cmimi
74006-1	6	<b>2.290</b>
74008-1	8	<b>2.390</b>
74010-1	10	<b>2.490</b>
74025-1	25	<b>4.590</b>



## DISPLAY PER 260 PUNTO (BOSH)



**3.250**

**AKD2688**

Nivele  
Dimensionet

4 nivele  
340mm x 320mm x 430mm  
Dizajn unik

## PUNTO COBALTI HSS - CO 5%



**E RE**



**5%Co**

Kodi	Permasa	Çmimi
DBT01130251(x2 cp)	2.5 mm	<b>160</b>
DBT01130301(x2 cp)	3.0 mm	<b>180</b>
DBT01130351	3.5 mm	<b>170</b>
DBT01130401	4.0 mm	<b>170</b>
DBT01130451	4.5 mm	<b>180</b>
DBT01130501	5.0 mm	<b>220</b>
DBT01130551	5.5 mm	<b>230</b>
DBT01130601	6.0 mm	<b>270</b>
DBT01130651	6.5 mm	<b>290</b>
DBT01130801	8.0 mm	<b>490</b>
DBT01130851	8.5 mm	<b>550</b>
DBT01130901	9.0 mm	<b>650</b>
DBT01131001	10 mm	<b>850</b>
DBT01130121	12 mm	<b>1.190</b>
DBT01130141	14 mm	<b>1.590</b>
DBT01130161	16 mm	<b>2.190</b>

## PUNTO BETONI



**E RE**

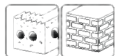

Kodi	Permasa	Çmimi
DBM2110610	6x100 mm	<b>120</b>
DBM2110615	6x150 mm	<b>160</b>
DBM2110812	8x120 mm	<b>170</b>
DBM2110815	8x150 mm	<b>190</b>
DBM2111012	10x120 mm	<b>220</b>
DBM2111015	10x150 mm	<b>250</b>
DBM2111215	12x150 mm	<b>280</b>

## PUNTO BETONI



Kodi	Permasa	Çmimi
DBM111041	4x75 mm	<b>50</b>
DBM111051	5x85 mm	<b>90</b>
DBM111062	6x150 mm	<b>160</b>
DBM111081	8x120 mm	<b>180</b>
DBM111083	8x200 mm	<b>230</b>
DBM111101	10x120 mm	<b>230</b>
DBM111121	12x150 mm	<b>280</b>
DBM111142	14x200 mm	<b>320</b>
DBM111162	16x200 mm	<b>450</b>

## PUNTO XHAMI DHE QERAMIKE



Kodi	Permasa	Çmimi
DBG1110401	4 x 64 mm	<b>150</b>
DBG1110501	5 x 70 mm	<b>220</b>

## SET ME 5 PUNTO XHAMI DHE QERAMIKE

**1.590**

**AKD7058**



Permasa

4mm,5mm,6mm,8mm,10mm



## PUNTO SDS-PLUS

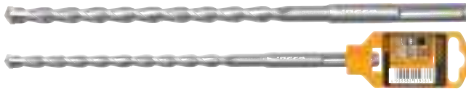

Kodi	Permasa	Çmimi
DBH1210501	5x110 mm	<b>150</b>
DBH1210601	6x110 mm	<b>170</b>
DBH1210602	6x160 mm	<b>180</b>
DBH1210603	6x210 mm	<b>220</b>
DBH1210604	6x260 mm	<b>260</b>
DBH1210801	8x110 mm	<b>170</b>
DBH1210802	8x160 mm	<b>190</b>
DBH1210803	8x210 mm	<b>240</b>
DBH1210804	8x260 mm	<b>280</b>
DBH1210806	8x450 mm	<b>490</b>
DBH1211002	10x160 mm	<b>230</b>
DBH1211003	10x210 mm	<b>270</b>
DBH1211004	10x260 mm	<b>290</b>
DBH1211006	10x450 mm	<b>550</b>
DBH1211201	12x160 mm	<b>270</b>
DBH1211202	12x210 mm	<b>290</b>
DBH1211203	12x260 mm	<b>320</b>
DBH1211205	12x450 mm	<b>550</b>
DBH1211402	14x210 mm	<b>330</b>
DBH1211403	14x260 mm	<b>390</b>
DBH1211405	14x450 mm	<b>650</b>
DBH1211602	16x210 mm	<b>390</b>
DBH1211603	16x260 mm	<b>460</b>
DBH1211605	16x450 mm	<b>670</b>
DBH1211801	18x210 mm	<b>590</b>
DBH1211804	18x450 mm	<b>890</b>
DBH1212001	20x210 mm	<b>790</b>
DBH1212004	20x450 mm	<b>990</b>
DBH1212005	20x600 mm	<b>1.290</b>
DBH1212204	22x600 mm	<b>1.450</b>
DBH1212504	25x600 mm	<b>1.650</b>

## SET ME 10 PUNTO / DALTA SDS-PLUS

**1.690**

**AKD2101**



Sasia (8 punto + 2 dalta)  
 Dalta 14 x 250 mm, 14 x 250 x 20 mm  
 Punto 6X160mm, 8X160mm, 10X160mm, 8X210mm, 10X210mm, 12X210mm, 14X210mm, 16X210mm

## PUNTO SDS-PLUS ME 4 KOKA



Kodi	Permasa	Çmimi
DBH1210602C	6x160 mm	<b>160</b>
DBH1210603C	6x210 mm	<b>180</b>
DBH1210802C	8x160 mm	<b>190</b>
DBH1210803C	8x210 mm	<b>230</b>
DBH1211002C	10x160 mm	<b>250</b>
DBH1211003C	10x210 mm	<b>270</b>
DBH1211201C	12x160 mm	<b>290</b>
DBH1211404C	14x310 mm	<b>490</b>
DBH1211603C	16x260 mm	<b>530</b>
DBH1211604C	16x310 mm	<b>620</b>
DBH1211803C	18x310 mm	<b>690</b>
DBH1212003C	20x310 mm	<b>890</b>
DBH1212202C	22x310 mm	<b>990</b>

## PUNTO SDS-MAX



Kodi	Permasa	Çmimi
DBH1241805	18x540 mm	<b>1.690</b>
DBH1242005	20x540 mm	<b>1.990</b>
DBH1242205	22x540 mm	<b>2.150</b>
DBH1242505	24x540 mm	<b>2.350</b>
DBH1242805	28x540 mm	<b>3.290</b>
DBH1243005	30x540 mm	<b>3.850</b>
DBH1253260	32x600 mm	<b>4.500</b>
DBH1253280	32x800 mm	<b>4.990</b>
DBH1243208	32x1000 mm	<b>5.890</b>

## PUNTO BETONI ECO PA SHLICA



Kodi	Permasa	Çmimi
DBM112101	10x120 mm	<b>90</b>

### DALTE SDS-PLUS ME MAJE

**SDS PLUS** 14x250mm

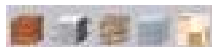

Kodi	Permasa	Çmimi
DBC0112501	250 mm	<b>270</b>

### DALTE SDS-PLUS E GJERE

**SDS PLUS**



Kodi	Permasa	Çmimi
DBC0122502	40 x 250 mm	<b>390</b>

### DALTE SDS-MAX E SHESHTE

**SDS MAX**



Kodi	Permasa	Çmimi
DBC0222801	18 x 300 mm	<b>550</b>

### DALTE SDS-MAX E GJERE

**SDS MAX**



Kodi	Permasa	Çmimi
DBC0224002	50 x 400 mm	<b>790</b>

### DALTE HEXAGON E SHESHTE

**SDS HEX**



Kodi	Permasa	Çmimi
DBC0324102	30 x 410 x 40 mm	<b>1.990</b>

### DALTE SDS-PLUS E SHESHTE

**SDS PLUS**

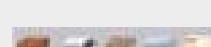

Kodi	Permasa	Çmimi
DBC0122501	20 x 250 mm	<b>270</b>

### DALTE SDS-MAX ME MAJE

**SDS MAX**

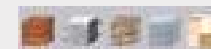

Kodi	Permasa	Çmimi
DBC0212801	300 mm	<b>490</b>
DBC0214001	400 mm	<b>690</b>

### DALTE SDS-MAX E SHESHTE

**SDS MAX**



Kodi	Permasa	Çmimi
DBC0224001	18 x 400 mm	<b>690</b>

### DALTE HEXAGON ME MAJE

**SDS HEX**

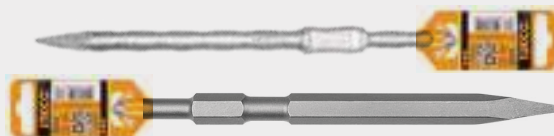

Kodi	Permasa	Çmimi
DBC0512801	17 x 280 mm	<b>290</b>
DBC0314101	30 x 410 mm	<b>2.350</b>

### DALTE E SHESHTE HEX PER PDB13008

**SDS HEX**



Kodi	Permasa	Çmimi
DBC0522801	17 x 280 x 22 mm	<b>350</b>

**SET PUNTO METALI HSS TWIST PER VIDIATOR**

**360**

**AKD1401**



Permasa  
Kapja

(1.5,2.5,3.5,4.0mm)  
1/4" Hex

**SET ME 6 PUNTO METALI HSS**

**270**

**AKDB1065**



Permasa  
Paketimi

(2x49, 3x61, 4x75, 5x86, 6x93, 8x117)  
Kuti plastike

**SET ME 7 PUNTO METALI HSS TWIST**

**350**

**AKD1075**



Permasa  
Paketimi

(2,2,3,3,4,5,6 mm)  
Kuti plastike

**SET ME 8 PUNTO METALI HSS**

**270**

**AKDB0801**



Permasa  
Paketimi

(2,3,3,4,4,5,6,8 mm)  
Kuti plastike

**SET ME 9 PUNTO METALI HSS TWIST**

**690**

**AKD1095**



Permasa

(2,3,3,5,4,4,5,5,6,8,10 mm)

**SET ME 12 PUNTO METALI HSS - CO**

**530**

**AKDB1125**



Sasia  
Permasa

12 Cope  
2 - 8 mm

**SET PUNTO METALI HSS-G 25 COPE**

**8.500**

**AKD1251**



Permasa

1-13mm/0.5mm

**SET SDS MAX 7 COPE (4 PUNTO / 3 DALTA)**

**4.990**

**AKD5075**



Sasia  
4 Punto

3 Dalta



**SET ME 5 PUNTO SDS-PLUS**



**790**

**AKD2052**

Permasa: (6x110, 8x110, 8x160, 10x160, 12x160)  
 Paketimi: Kuti plastike

**SET ME 9 PUNTO SDS-PLUS**



**1.690**

**AKDL30901**

Permasa: 5x110mm, 6x110mm, 8x110mm, 8x160mm, 10x160mm, 12x160mm, 14x160mm, 16x160mm

**SET ME 22 PUNTO SDS-PLUS DHE MAJA**



**2.690**

**AKDL12201**

Permban: 8 maja per vidiator, 6 punto xhami, 5 punto betoni, 3 punto SDS-Plus per trapan

**SET ME 3 PUNTO KONIKE ME SHKALLE**



**2.550**

**AKSDS0301**

Permasa

4 - 32mm

**PUNTO KONIKE PER VIDIAOTOR**

**E RE**



**1.490**

**AKSDS63503**

Permasa: 6 - 35 mm  
 Hapi: 6-10-13-16-19-22-25-29-32-35 mm

**PUNTO KONIKE PER VIDIAOTOR**



**1.990**

**AKSDS63803**

Permasa: 6 - 38 mm  
 Hapi: 6-8-11-14-17-20-23-26-29-32-35-38 mm

**PUNTO KONIKE ME SHKALLE**

**E RE**



**1.690**

**AKSDS06381**

Permasa: 6-8-11-14-17-20-23-26-29-32-35-38 mm

**PUNTO KONIKE ME SHKALLE**

**E RE**



**2.490**

**AKSDS10453**

Permasa: 10 - 45 mm  
 Hapi: 10-15-20-25-30-35-40-45 mm

**SET ME 4 PUNTO PER TRAPAN  
SDS-PLUS**

**650**

**AKDB2055**



Permasa  
Paketimi

6x110, 6x160, 8x160, 10x160 mm  
Blister plastike

**SET ME 5 PUNTO BETONI PA SHLICA**

**350**

**AKDB3055**



Permasa  
Paketimi

(4x75, 5x85, 6x100, 8x120, 10x120)  
Blister plastike

**SET ME 5 PUNTO BETONI**

**750**

**AKD3051**



Permasa  
Paketimi

(4x75, 5x85, 6x100, 8x120, 10x120)  
Kuti plastike

**SET ME 16 PUNTO DHE MAJA**

**550**

**AKSDB9165**



Permban

6 Punto HSS: 2,3,3.5,4,5,6mm  
4 punto betoni :4,5,6,8mm, 6 maja 25mm

**SET ME 5 PUNTO DRURI**

**290**

**AKDB5055**



Permasa  
Paketimi

(3x61, 4x75, 5x86, 6x93, 8x117)  
Kuti plastike

**SET ME 5 PUNTO DRURI**

**390**

**AKD5058**



Permasa  
Paketimi

4 mm, 5 mm, 6 mm, 8 mm, 10 mm  
Kuti plastike

**SET ME 12 PUNTO DRURI TE SHESHTA**

**2.550**

**AKDL1201**



Permasa  
Gjatesia

6,8,10,12,14,16,18,20,25,28,30,32  
152 mm

**SET ME 13 PUNTO DRURI TE SHESHTA**

**2.690**

**AKD41301**



Sasia  
Permasa

13 Cope  
6 - 38 mm

### SET LULE FREZE 6 MM 12 COPE

2.550

AKRT1201



Kapja 6 mm, 1/2"-1/4"  
Sasia 12 Cope

### SET LULE FREZE 8 MM 12 COPE

2.690

AKRT1211



Kapja 8 mm, 1/2"-1/4"  
Sasia 12 Cope

### SET LULE FREZE 12 MM 12 COPE

2.390

AKRT1221



Kapja 12 mm, 1/2"-1/4"  
Sasia 12 Cope

### PUNTO FREZE 25 MM



Kodi	Diametri	Çmimi
ADCS2501	25 mm	450
ADCS3201	32 mm	500

### PUNTO FREZE 35 MM

650

ADCS3501



Diametri 35 mm

### SET ME 3 PUNTO KONIKE PER VIDIA TOR

650

DBCS0031



Permasa 12mm, 16mm, 19mm  
Kendi: 90°

### SET ME 7 GOTA DRURI

590

AKHS702



Permasat 26, 32, 38, 50, 56, 63 mm  
Lartesia 50mm (2")

### SET ME 10 AKSESORE PER ZMERILUESE

MG13328  
MG2008  
CMGLI2001

390

AKB1012



Aksesore 10 cope



### SET ME 10 AKSESORE PER MINI ZMERILUESE

270

AKB1001



Permban

5 cope PDG5501  
5 cope MG13328

### SET AKSESORE PER MAKINERI MULTI FUNKSIONALE

1.450

AKTMT1502



Sasia

15 cope

### SET ME 250 AKSESORE PER MINI TRAPANE

3.390

AKMG2501



Sasia

250 cope

### SET ME 420 AKSESORE PER MINI ZMERILUESEN

2.390

AKMG4208



Sasia

420 cope

### GOTE DIAMANTI PER TRAPAN KOLLONE



Kodi	Diametri	Çmimi
DCB580528	52 mm	<b>5.900</b>
DCB580658	65 mm	<b>6.900</b>
DCB580828	82 mm	<b>8.900</b>
DCB581028	102 mm	<b>10.500</b>
DCB581228	122 mm	<b>12.500</b>
DCB581528	152 mm	<b>16.900</b>

### SET ME GOTA PER HAPJE VRIMASH NE PLLAKE

2.250

AKCH0071



Permasa

33 mm, 53 mm, 67 mm, 73 mm, 83 mm

### SET ME 13 GOTA BI-METALI

4.990

AKH0131



Permasa 9 Gota: 19, 22, 29, 35, 38, 44, 51, 57, 64 mm  
2 gota, 1 adaptor, 1 punto qendre 102mm x 6.35mm

### SET ME 12 GOTA BI-METALI

6.790

AKH0121



Sasia

12 Cope

Permasa

20, 22, 25, 29, 32, 35, 38, 44, 48, 50 mm

## GOTE BI-METAL



Kodi	Permasa	Çmimi
HSB10161	16 mm	<b>150</b>
HSB10191	19 mm	<b>170</b>
HSB10221	22 mm	<b>180</b>
HSB10251	25 mm	<b>200</b>
HSB10321	32 mm	<b>360</b>
HSB10381	38 mm	<b>430</b>
HSB10461	46 mm	<b>500</b>
HSB10511	51 mm	<b>720</b>
HSB10641	64 mm	<b>860</b>
HSB10761	76 mm	<b>990</b>

## GOTE BETONI SDS-PLUS



Kodi	Diametri	Çmimi
HCB0501	50 mm	<b>1.090</b>
HCB0651	65 mm	<b>1.450</b>
HCB0801	80 mm	<b>1.590</b>
HCB1001	100 mm	<b>1.690</b>

## ZGJATUES PER GOTA BETONI SDS PLUS + PUNTO

**450mm**



Kodi	Permasa	Çmimi
HCBA14501	450 mm	<b>890</b>

## ADAPTOR PUNTO GOTE



Kodi	Permasa	Çmimi
HSA01	14 - 30 mm	<b>350</b>

## ADAPTOR PUNTO GOTE



Kodi	Permasa	Çmimi
HSA02	32 - 110 mm	<b>850</b>

## GOTE SHPIMI INOXI ME VIDEO



Kodi	Permasa	Çmimi
HSB70201	20 mm	<b>270</b>
HSB70221	22 mm	<b>290</b>
HSB70251	25 mm	<b>300</b>
HSB70281	28 mm	<b>330</b>
HSB70321	32 mm	<b>350</b>
HSB70351	35 mm	<b>390</b>

## ZGJATUES PER GOTA BETONI SDS PLUS + PUNTO

**350mm**

**M22 PLUS**



Kodi	Permasa	Çmimi
HCBA13501	350 mm	<b>790</b>

**SET ME 11 FURCA PASTRIMI PER TRAPAN**

**2.550**

**WCB1101**



**11PCS/SET**

Sasia  
Kapja

11 furca  
1/4" Hex

**SET ME 3 FURCA TE MESME PER TRAPAN**

**890**

**WCBM0301**



Medium bristle **3PCS/SET**

Sasia  
Kapja

3 furca  
1/4" Hex

**FURCE E ASHPER PER TRAPAN 4"**

**ERE**

**450**

**WCBH1401**



Hard bristle **4"**

Permasa  
Kapja

4"  
1/4" Hex

**FURCE E IMET PER TRAPAN 4"**

**ERE**

**450**

**WCBS1401**



Soft bristle **4"**

Permasa  
Kapja

4"  
1/4" Hex

**FURCE E MESME PER TRAPAN 4"**

**ERE**

**450**

**WCBM1041**



Medium Bristle **4"**

Permasa  
Kapja

4"  
1/4" Hex

**SET ME 2 FURCA PASTRIMI TE ASHPRA PER TRAPAN**

**ERE**

**690**

**WCBH1235**



**2PCS/SET**

Sasia  
Kapja

3 furca  
1/4" Hex

**SET ME 2 FURCA TE MESME ME ZGJATUES PER TRAPAN**

**ERE**

**1.290**

**WCBH0301**



**2PCS/SET**

2PCS Abrasive Bristle  
Brush Cleaning Kit With Extension

Sasia  
Kapja

2 furca  
1/4" Hex

**FURCE PER TRAPAN 4"**

**ERE**

**550**

**WCBM1360**



Medium bristle

Rrotullimi  
Kapja

360°  
1/4" Hex





**MAKINERI NDËRTIMI**

**DHE AKSESORË**



**PRERESE ASFALTI ME BENZINE  
(PA DISK)**

**115.000**

**GSF16-2E**

**14cm(5.5")** 120KGS  
Engine  
INGCO 13HP

Fuqia 9.6 kw (13HP)  
Permasa diskut 300 - 450 mm

**PRERESE ASFALTI ME BENZINE  
(PA DISK)**

**135.000**

**GSF16-1**

**HONDA**  
INDUSTRIAL  
**120kgs**  
Engine:  
Honda 13HP

Fuqia 9.6 kw (13HP)  
Max prerjes 300 - 450 mm

**DISK DIAMANTI PER PRERJE BETONI  
ME LASER**

**9.900**

**DMD044052**

Fast cut  
WET  
Concrete  
INGCO  
LONG LIFE  
405 mm

Disku 405 mm (16") X 25.4 mm  
E pershtatshme per: GSF16-1 ,GSF16-2E

**DISK DIAMANTI PER PRERJE ASFALTI  
ME LASER**

**9.900**

**DMD064051**

Fast cut  
WET  
Asphalt  
INGCO  
LONG LIFE  
405 mm

Disku 405mm(16")X25.4mm  
E pershtatshme per: GSF16-1 ,GSF16-2E

**PRERESE BETONI ELEKTRIKE**

**32.900**

**PC3558**

Fuqia 2800 W  
Disku 355 x 25.4 x 3mm  
Nr i rrotullimeve bosh 4800 rpm  
Thellesi prerje 120 mm

**DISK PER PRERESE BETONI**

**2.550**

**DMD033551**

Fast cut  
WET  
Asphalt  
INGCO  
LONG LIFE  
355 mm

Disku 355mm(14")X25.4mm  
Gjeresia 12 mm  
E pershtatshme per: PC3558

### TOKMAK ME BENZINE MOTOR HONDA

85.000

GRT75-2



MADE IN GERMANY

Fuqia  
Permasa e ngjeshjes  
Pesha

4.8 kw (6.5 HP)  
33 x 29 cm  
79 kg

### TOKMAK ME BENZINE MOTOR HONDA

Motor HONDA GX160

HONDA

99.900

GRT75-1



MADE IN GERMANY

Motor  
Fuqia  
Permasa e ngjeshjes  
Pesha

Honda GX160  
4.0 kw(5.5HP)  
33 x 29 cm  
79 kg

### NGJESHES ME BENZINE

HONDA

Motor HONDA GX160

IRI

59.000

GCP100-2



90KGS  
Engine  
INGCO 6.5HP  
Forward

Fuqia  
Permasa e ngjeshjes  
Pesha

4.8 kW(6.5 HP)  
56 x 44 cm  
90 kg

### NGJESHES ME BENZINE PARA-MBRAPA

HONDA

Motor HONDA GX160

126KGS

Engine  
Honda 5.5HP  
Forward  
Backward

99.900

GCP125-1



Motori  
Fuqia  
Permasa ngjeshjes  
Pesha

Honda GX160  
4.0 kw(5.5HP)  
63 x 40 cm  
126 kg

### BETONIERE ELEKTRIKE 800 W

E RE

180L

37.900

CM30-1E



100% Copper Coil Alternator

Fuqia  
Kazani

800 W  
180 lt

### BETONIERE ELEKTRIKE LIMEX

MADE IN EU

ALTRAD



Kodi	Fuqia / Depozita	Çmimi
106001	700 W / 125 Lt	35.900
106011	700 W / 165 Lt	39.900
106016	700 W / 190 Lt	43.900



## HELIKOPTER BETONI

64.500

GPT361-2



Motori Honda GX160  
Fuqia 4.8 kw (6.5 HP)  
Diametri 91 cm  
Pesha 78 kg

## HELIKOPTER BETONI

**HONDA**

Motor HONDA GX160

83.500

GPT361-1



Motori Honda GX160  
Fuqia 4.0 kw(5.5 HP)  
Diametri 91 cm(36")  
Pesha 78 kg

## VIBRATOR BETONI ME BENZINE PA TUB

**21.5KGS**

Engine: **INGCO 5.5HP**

25.900

GVR-2



Motor INGCO 5.5 HP  
Fuqia 4.0 kW(5.5HP)

## VIBRATOR BETONI ME BENZINE MOTOR HONDA

**HONDA**

**21KGS**

Engine: **Honda 5.5HP**

49.900

GVR-1

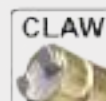

Motor Honda GX160  
Fuqia 4.0 kW(5.5HP)

## TUB VIBRIMI PER BETON



**CLAW**

Kodi	Permasa	Çmimi
VBP1381	580 x 38 mm x 6 m	<b>12.900</b>
VBP1451	580 x 45 mm x 6 m	<b>13.900</b>

## TUB VIBRIMI PER BETON



**CLAW**

Kodi	Permasa	Çmimi
VBP1601	580 X 60 mm x 6 m	<b>15.900</b>



**MAKINERI SALDIMI**

**DHE AKSESORË**



# MMA

## Saldimi me elektrode te veshur

Saldimi me hark elektrik me elektrode (MMA) gjenerohet mes elektrodës së vendosur dhe materialit bazë. Saldimi me hark elektrik me elektrode është një nga proceset salduese më të vjetra dhe më të zhdërvjellta, si dhe konsiderohet si një nga metodat më të thjeshta dhe më të sigurta. Ky proces përdoret për të salduar metallet me ngjyrë si hekur, llojet e ndryshme të çelikut, inoksin dhe gizen. Në materiale të tjera saldimi MMA nuk është shumë efektiv.

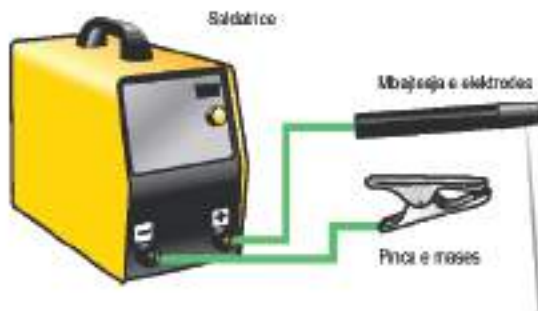
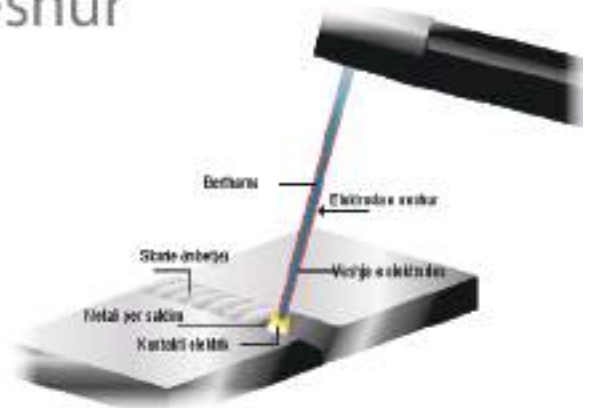

### Avantazhet

Saldim në çdo pozicion.  
Përdoret në ambiente të mbrambur dhe të jashtme.  
Mbrojtje elektrode dhe inok nëvojitet gas apo lëngje ftohëse.  
Portative dhe lehtësisht e montueshmë.

### Disavantazhet

Produktivitet i ulët  
Nevojitet person me njohuri të mira

# MIG

## Saldim me tel të vazhduar

Saldimi MIG/MAG (Copëza metal/saldim me gas aktiv), shkaktohet nga rrethësia e gjeneruar nga një shkëndijë e materialit që do të saldohet me elektrodën në formë teli e cila bën mbushjen dhe ngjyjen e materialit. Teli është i mbledhur në bobina me permata të ndryshme dhe del tek hundëza nëpërmjet një sistemi automatik. Shkrijja është e mbrojtur nga kontaminimi në atmosferë nëpërmjet perzjerjes të gazit Argon ose gazeve të tjera aktive të cilat dalin në të njëjtën forcë. Teli është i prodhuar nga një material i vetëm ose në formë tubi i mbushur me grimca që përmirësojnë procesin e ngjyjes. Disa lloje të telit të mbushur mund të përdoren pa gas dhe janë të çelësura në trup NO-GAS. Teli i mbushur gjithashtu në fund të saldimit gjeneron skorë (mbetje) ndërsa teli pa mbushur nuk krijon skorë apo mbetje të tjera.

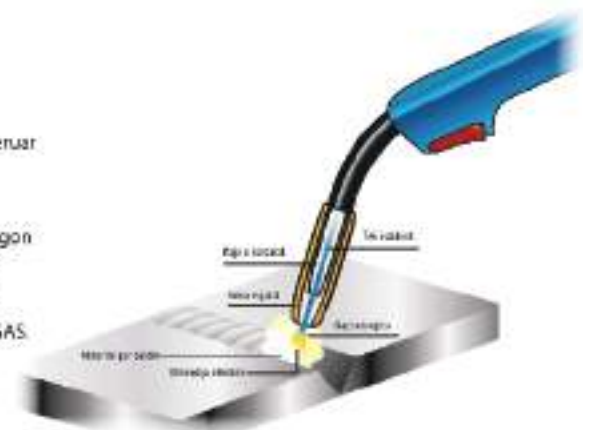

Procesi i saldimit MIG/MAG zakonisht përdoret për saldimin e:  
Hekurit dhe çelikut jo aliazh  
Aliazheve dhe inoksit  
Aluminit dhe aliazheve  
Ky proces tejkalon kufijtë e saldimit MMA me elektrode dhe si rrjedhojë ka produktivitet më të lartë.  
Me diversitetin e lartë të trashësive të telit mund të bashkohet lehtësisht hapësira të vogla ose të mëdha duke rritur trashësinë dhe shpejtësinë e telit.



# TIG

## Saldimi TIG

Saldimi TIG (Saldimi me gas dhe elektrode tungsteni) shfrytëzon nxehësinë e gjeneruar nga një shkëndijë e cila hapet midis pjesës që do të ngjitet dhe një elektrode tungsteni infuzive, nën mbrojtjen e një gazi, i cili zakonisht është argon ose një përzierje argon-helium.

Saldimi kryhet pa patur nevojën e materiale mbushëse ose kur është nevojë me një shufër TIG e cila është homogjene me materialin i cili saldohet.

Procesi i saldimit TIG mund të përdoret në të gjitha materialet por në veçanti:

- Inoksi
- Baker
- Bronz
- Titan
- Nikel
- Aluminin dhe aliazhet
- Aliazhet e magnezit.

Ky proces është estetikisht i bukur dhe në një performancë të lartë. Produktiviteti në saldimit TIG nuk është shumë i lartë.

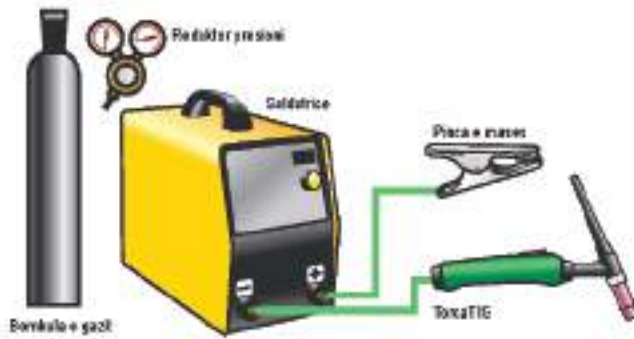
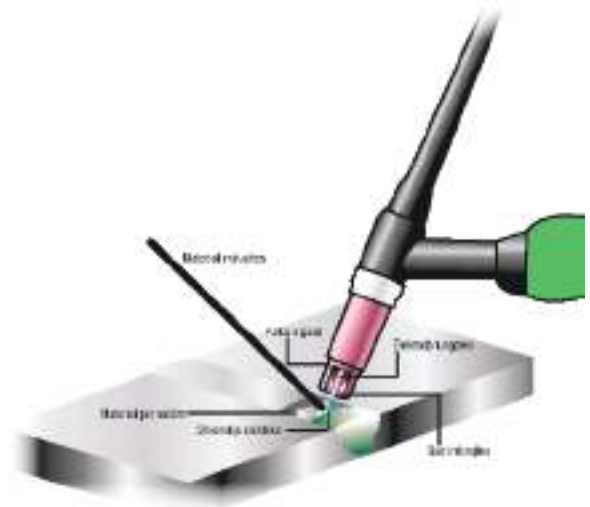

### Avantazhet

- Cilesi e lartë saldimit
- Saldim estetikisht i pastër
- Saldim preciz
- Saldim dhe në spesor të hollë

### Disavantazhet

- Nevojitet person me aftësi të mira
- Produktiviteti i ulët
- Saldim në nivel profesional

# PAC

## Prerja Plazma

Plazma është një gaz i fortë i jonizuar, përkatësisht i përbërë nga grimca të presuara, dhe prandaj është përques i rrymës elektrike. Grimcat e presuara bashkë me gazin kalojnë brenda një ngushtese mekanike dhe në këtë mënyrë përqendrimi i grimcave të presuara rritet ndjeshëm, dhe rrjedhimisht efekti termik dhe temperatura rriten ndjeshëm.

Gazi me temperaturë të lartë tenton të zgjerohet dhe përmes ngushtimit, të ftojë një shpejtësi shumë të lartë sa arrijn të presin metallet.

Një implant për prerjen me plazmë mund të bëhet duke përdorur një gjenerator aktual të përshtatshëm, një burim gazi dhe një ndezës i cili krijon shkëndijën elektrike.

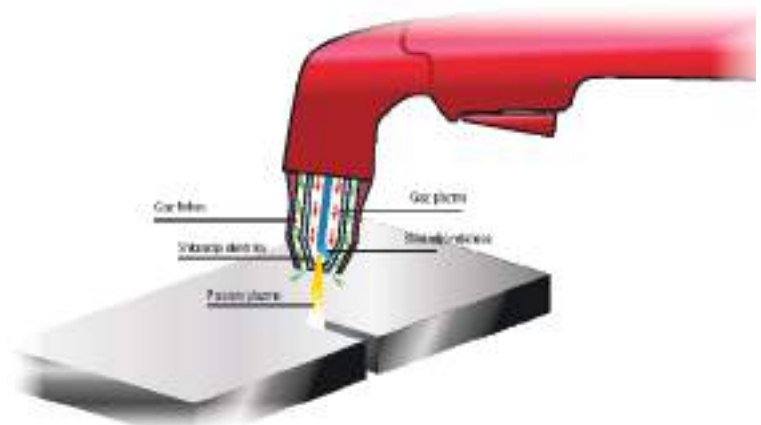

### SALDATRICE INVERTER MINI 130 A

**ERE**

**130A**  
220-240V~50/60Hz  
MMA



LED display



7.900

ING-MMA13049

Ryma soldimit  
Elektroda

Arc-force Hot Start Anti Sticking 130 A  
1.6-3.2 mm

### SALDATRIÇE INVERTER MMA 130 A

**ERE**



8.900

ING-MMA13028

Ryma soldimit  
Elektrode

Arc-force Hot Start Anti Sticking 130 A  
1.6-3.2 mm



### SALDATRICE INVERTER MINI 160 A

**ERE**

**160A**  
220-240V~50/60Hz  
MMA



LED display



9.900

ING-MMA16018

Ryma soldimit  
Elektroda

Arc-force Hot Start Anti Sticking 160 A  
1.6-3.2 mm

### SALDATRIÇE INVERTER MMA 160 A

**ERE**



11.500

ING-MMA16028

Ryma soldimit  
Elektrode

Arc-force Hot Start Anti Sticking 160 A  
1.6-4.0 mm



### SALDATRICE INVERTER MINI 180 A

**ERE**

**180A**  
220-240V~50/60Hz  
MMA



LED display



11.900

ING-MMA18058

Ryma soldimit  
Elektroda

Arc-force Hot Start Anti Sticking 180 A  
1.6-4.0 mm

### SALDATRIÇE INVERTER MMA 180 A

**ERE**



12.900

ING-MMA18028

Ryma soldimit  
Elektrode

Arc-force Hot Start Anti Sticking 180 A  
1.6-4.0 mm



### SALDATRIÇE INVERTER MMA 200 A

13.500

ING-MMA20038

Ryma soldimit  
Elektrode



200 A  
1.6-4.0 mm

### SALDATRICE INVERTER MMA/TIG 200 A

13.900

ING-MMA200381

Ryma soldimit  
Elektrode



200 A  
1.6-4.0 mm



### SALDATRICE INVERTER MMA 200 A

**ERE**

**200A**  
220-240V~50/60Hz  
**MMA**

**PROFESSIONAL**  
LED display

**14.500**

ING-MMA20069



Ryma saldimit 200 A  
Elektrode 1.6-4.0 mm

### SALDATRICE INVERTER MMA 200 A

**ERE**

**200A**  
220-240V~50/60Hz  
**MMA**  
LIFT TIG  
VRD

**PROFESSIONAL**  
LED display

**14.900**

ING-MMA200691



Ryma saldimit 200 A  
Elektrode 1.6-4.0 mm

### SALDATRICE INVERTER MMA 250 A



**21.900**

ING-MMA2506



Ryma saldimit 250 A  
Elektrode 1.6-5.0 mm

### SALDATRICE INVERTER MMA/TIG 250 A 220 / 380V

**ERE**

**250A**  
220/380V~50/60Hz  
**MMA**  
LIFT TIG  
VRD

**PROFESSIONAL**  
LCD screen

**28.900**

ING-MMA25079

ME AKSESORE



Ryma saldimit 250 A  
Elektrode Arc-force Hot Start Anti Sticking 1.6-5.0 mm

### SALDATRICE INVERTER 220 / 380 V MMA 250 A

**250A**  
**MMA**

LED display

**24.500**

ING-MMA2508

PA AKSESORE



Ryma saldimit 250 A  
Elektrode 1.6-5.0 mm

### SALDATRICE INVERTER TIG/MMA 160 A

**160A**

**HF TIG**  
**MMA**

**GENERAL**  
WELDING

LED display

**37.500**

ING-TIG1601



Ryma saldimit 160 A  
Elektrode 1.6-4.0 mm

### SALDATRICE INVERTER TREFAZORE MMA 400 A

**ERE**

**PROFESSIONAL**

**400A**  
330-400V~50/60Hz

**MMA**  
LED display

**39.900**

ING-MMA40010

PA AKSESORE



Ryma saldimit 400A  
Elektrode 2.5-5.0 mm

### SALDATRICE INVERTER TREFAZORE MMA 500 A

**ERE**

**PROFESSIONAL**

**500A**  
380-400V~50/60Hz

**MMA**  
LED display

**59.500**

ING-MMA5008

PA AKSESORE



Ryma saldimit 500 A  
Elektrode 3.2-5.0 mm



### SALDATRICE INVERTER TIG/MMA 200 A

**ERE**

**200A**  
220-240V~50/60Hz  
AC/DC TIG

GENERAL  
WELDING  
LED display

59.500

ING-ACDCTIG2001



Ryma saldimit  
Elektrode

200A  
1.6-4.0 mm

### SALDATRICE ME TEL MIG

**130A**  
MIG

GENERAL  
WELDING



No Gas Required

12.900

ING-FC13012



Ryma saldimit  
Rendimenti  
Teli

130 A  
40%  
0.8/0.9mm

### SALDATRICE MIG/MMAG/TIG/

**160A**  
MAG/MIG

MMA  
LIFT TIG

LED display

GENERAL  
WELDING

36.900

ING-MGT1601



Ryma saldimit  
Elektrode  
Teli  
E kompletuar

160 A  
1.6-4.0 mm  
0.6,0.8,1.0mm  
Me askesore MIG dhe MMA

### SALDATRICE PRERESE PLAZMA INVERTER

40A



28.900

ING-CUT401



Ryma saldimit  
Trashesia e prerjes

40 A  
12 mm

### MOTOSALDATRICE GJENERATOR ME NAFTE

Ndezje elektrike dhe litar



199.000

GDW65001



Fuqia  
Ryma saldimit

4.6 kW / 9.0 Hp  
50- 180 Ah  
Ndezje elektrike dhe litar



### SALDATRICE INVERTER MMA 160 A ME EKTRAN LED

**ERE**

LED display

MMA

9.500

WWD11601



Ryma saldimit  
Elektrode

160 A  
1.6-3.2 mm

### SALDATRICE INVERTER MMA 200A ME EKTRAN LED

**ERE**

LED display

MMA

12.500

WWD32001

Ryma saldimit  
Elektrode



200 A  
1.6-4.0 mm

### SALDATRICE INVERTER MAG/MIG/MMA/TIG/LIFT 250A ME EKTRAN LED

**ERE**

MIG

79.900

WGTMWA25

Ryma saldimit  
Elektrode

250 A  
1.6-4.0 mm/ Teli 15 kg 0.6/0.8/1.0



**KARIKUES DHE STARTER 70-300 AH**

**18.500**

**ING-CD2201**



Tensioni  
Kapaciteti

12-24 V  
70 - 300 A

**KARIKUES DHE STARTER 160 - 1200 AH**

**20.900**

**ING-CB70035**



Tensioni  
Kapaciteti

12 / 24 V  
160 - 1200 Ah

**KARIKUES BATERIE MAKINASH 6 - 12 V**

**5.900**

**ING-CB1501**



Tensioni  
Kapaciteti

240 V  
40-90 AH

**KARIKUES BATERIE MAKINASH 12 - 24 V**

**6.900**

**ING-CB1601**



Tensioni  
Kapaciteti

240 V  
28 - 180 Ah

**KARIKUES BATERIE MAKINASH 6/12V**

**IRI**

**3.500**

**WBY15041**



Tensioni  
Kapaciteti

6 / 12 V  
6V 2A 12V 4A

**KARIKUES BATERIE MAKINASH 12/24V**

**IRI**

**5.500**

**WBY1A151**



Tensioni  
Kapaciteti

12 / 24 V  
12V 15A / 24V 7.5A

**KARIKUES DHE STARTER 20-750 AH**

**IRI**

**21.500**

**WBY1A50**



Tensioni  
Kapaciteti

12 / 24 V  
20-750Ah

**TEL PER SALDIM PA GAS**

**1.450**

**EWSFC081001**

**Ø0.8mm**  
1KG/SPool



Permasa  
Kapaciteti

0.8 mm  
1 kg



**BIW1545**  
Saldatrice inverter  
Amperazhi 140 A  
Per elektroda 2.5 - 4.0 Ah

**8.500**



**BIW1570**  
Saldatrice inverter 170 A  
Max elektrodes 4.0 mm  
Ekran dixhital, maske, aksesore

**11.900**



**BIW2010**  
Saldatrice inverter 200 A  
Max elektrodes 4.0 mm  
Ekran dixhital, maske, aksesore

**13.900**



**BIW1135**  
Saldatrice MIG/MAG 130 A,  
pa gas 450 gr / 1000gr  
(0,8-0,9mm)

**23.500**



**BWH1000**  
Helmete saldimi elektronike  
me fotoelemente DIN11

**2.500**



**BWH2000**  
Helmete Saldimi DIN 5-9/9-13,  
Xham 98X53mm

**3.900**



**BFW1000**  
Tel saldimi per  
saldatrice pa gas  
0.8 mm 0.5 kg

**2.500**



**BMI1010**  
Inverter 12V-220V  
1000W , me porte  
USB 2.1 te perfshire

**5.900**



**BBC2015**  
Karikues baterie  
makinash  
12/24V - 40A



**12.900**



## Elektrode e bute

Kodi	Diametri (mm)	Gjatesia (mm)	Rryma (A)	Pesha Elektrodes (g/100 pcs)	Paketimi (kg) Sasia (cope)	Cmimi
EF-2.5	2.5	350	90-140	400	6	<b>1.390</b>
EF-3.2	3.2			400	6	<b>1.390</b>
EF-4.0	4.0			400	6	<b>1.490</b>



## Elektrode e forte

Kodi	Diametri (mm)	Gjatesia (mm)	Rryma (A)	Pesha Elektrodes (g/100 pcs)	Paketimi (kg) Sasia (cope)	Cmimi
ES-2.5	2.5	350	90-140	300	6	<b>1.490</b>
ES-3.2	3.2			450	6	<b>1.590</b>
ES-4.0	4.0			450	6	<b>1.590</b>



## Tel argoni 0.8 mm

Kodi	Diametri (mm)	Rryma (A)	Pesha Telit	Paketimi Sasia (cope)	Cmimi
TL-0.8/5	0.8	90-140	5	1	<b>1.990</b>
TL-0.8	0.8	90-140	15	1	<b>4.690</b>
TL-1.0/5	1.0	90-140	5	1	<b>1.990</b>
TL-1.0	1.0	90-140	15	1	<b>4.590</b>
TL-1.2	1.2	90-140	15	1	<b>4.490</b>



## Shufra bronxi

Kodi	Diametri (mm)	Gjatesia (mm)	Rryma (A)	Pesha Elektrodes (g/100 pcs)	Paketimi (kg) Sasia (cope)	Cmimi
SHB-3	3	100	90-140		1	<b>190</b>
SHB-4	4	100			1	<b>350</b>



## Elektrode e bute

Kodi	Diametri (mm)	Gjatesia (mm)	Rryma (A)	Pesha Elektrodes (g/100 pcs)	Paketimi (kg) Sasia (cope)	Cmimi
ELF-2.5	2.5	350	90-140	400	6	<b>990</b>
ELF-3.2	3.2	350		400	6	<b>990</b>



## Tel argoni

Kodi	Diametri (mm)	Rryma (A)	Pesha Telit	Paketimi Sasia (cope)	Cmimi
TLF-0.8/5	0.8	90-140	5	1	<b>1.500</b>
TLF-0.8	0.8	90-140	15	1	<b>3.900</b>
TLF-1.0/5	1.0	90-140	5	1	<b>1.500</b>
TLF-1.0	1.0	90-140	15	1	<b>3.900</b>
TLF-1.2	1.2	90-140	15	1	<b>3.900</b>



## ASPIK98

### Elektrode speciale gize

#### Klasifikimet

EN ISO 1071	:E C NiFe-13	EN ISO 1071	:E C NiFe-13
AWS A5.15	:NiFe-CI	AWS A5.15	:NiFe-CI
DIN 8573	:E NiFe1-BG 33	DIN 8573	:E NiFe1-BG 33

#### Përshkrim i përgjithshëm

ASPIK 55/98 Super është një elektrode me nikel. mundeson saldimit me transferimin metalik të harkut. Përdoret për saldimitin e të gjitha llojeve të prerjeve të hedhura. Ajo ka rezistencë të shkelqyer ndaj plasaritjeve.

#### Parametrat e saldimit / Paketimet dhe Informacionet e Diametrit

Current Type dhe Polariteti : DC (+)

Kodi	Diametri (mm)	Gjatesia (mm)	Rryma (A)	Pesha Elektrodes (g/100 pcs)	Paketimi (kg) Sasia (cope)	Cmimi
ASPIK98-4.00	4.00	350	90-140	4750	2.4/50	<b>6.900</b>



## Kobatek 381

### Elektrode për riparim detalesh

#### Përshkrim i përgjithshëm

Kobatek 381 depoziton një metal të bashkuar me çelik inox të bazuar në Cr / Ni / Mo. Është projektuar për bashkimin e komponentëve të mëdhenj dhe me forcë të lartë çeliku që kërkojnë depozita të shpejta me shumë shtresa me rezistencë ndaj plasaritjes

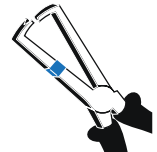

#### Parametrat e saldimit / Paketimet dhe Informacionet e Diametrit

Current Type dhe Polariteti : DC (+) AC

Kodi	Diametri (mm)	Gjatesia (mm)	Rryma (A)	Rryma (B)	Paketimi (kg) Sasia (cope)	Cmimi
KOBATEK381-2.50	2.50	350	90-120	70-80	5	<b>2.990</b>
KOBATEK381-3.25	3.25	350	130-150	110-120	5	<b>5.900</b>



## Kobatek 382

### Elektrode për riparimin e dhembeve të ingranazheve

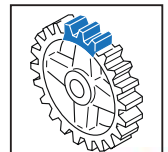

#### Parametrat e saldimit / Paketimet dhe Informacionet e Diametrit

Current Type dhe Polariteti : DC(+)

Kodi	Diametri (mm)	Gjatesia (mm)	Rryma (A)	Rryma (B)	Paketimi (kg) Sasia (cope)	Cmimi
KOBATEK382-3.25	3.25	350	90-100	60-80	5	<b>5.500</b>



### KOKE TORCE GAZI 96G/H CONSUM

950

73412



Temperatura  
Fuqja

1300 Grade  
1.3 kW

### MASE SALDIMI



Kodi	Amperazhi	Cmimi
74420	35 Ah	<b>1.350</b>
74421	70 Ah	<b>1.390</b>
74422	95 aH	<b>1.690</b>

### TEL KALLAJI

350

76830



Diametri  
Pesha

1 mm  
16 Gr

### TEL KALLAJI

1.590

76800



Diametri  
Pesha

0.5 mm  
100 Gr

### KABELL SALDIMI PVC 16 MM<sup>2</sup>



Kodi	Dimensioni	Cmimi
CAV000009/1	1 m	<b>590</b>
CAV000009	25 m	<b>13.900</b>
CAV000010	50 mm	<b>22.900</b>

### KABELL SALDIMI PVC 25 MM<sup>2</sup>



Kodi	Dimensioni	Cmimi
CAV000014/1	1 m	<b>850</b>
CAV000013	25 m	<b>19.900</b>
CAV000014	50 m	<b>34.900</b>

### KABELL SALDIMI PVC 35 MM<sup>2</sup>



Kodi	Dimensioni	Cmimi
CAV000021/1	1 m	<b>1.150</b>
CAV000020	25 m	<b>27.900</b>
CAV000021	50 mm	<b>49.900</b>

### KABELL SALDIMI PVC 50 / 70 MM<sup>2</sup>



Kodi	Dimensioni	Cmimi
CAV000027	50 mm <sup>2</sup> / 25 m	<b>36.900</b>
CAV000037	70 mm <sup>2</sup> / 25 m	<b>59.000</b>



			
<p><b>MA7043</b> Torçe saldimi ERGOPLUS 15, 3 M EURO</p>	<p><b>MA7243</b> Torçe saldimi ERGOPLUS 25, 3 M EURO</p>	<p><b>MA7245</b> Torçe saldimi ERGOPLUS 25, 5 M EURO</p>	
<p><b>8.900</b></p>	<p><b>11.500</b></p>	<p><b>14.900</b></p>	
			
<p><b>MA7446</b> Torçe saldimi ERGOPLUS 36, 3M EURO - me guajne M8 Y</p>	<p><b>MB3724</b> Torçe saldimi TORCH TPLUS 500, 4M EURO</p>	<p><b>GM0531</b> Guajne çeliku per torçe saldimi Ø 1.2-1.6, 4 m</p>	
<p><b>13.900</b></p>	<p><b>27.900</b></p>	<p><b>790</b></p>	
			
<p><b>GM0500</b> Guajne çeliku per torçe saldimi Ø 0.6-0.9, 3 m</p>	<p><b>GM0510</b> Guajne çeliku per torçe saldimi Ø 1.0-1.2, 3 m</p>	<p><b>GM0512</b> Guajne çeliku per torçe saldimi Ø 1.0-1.2, 5 m</p>	<p><b>GM0542</b> Guajne çeliku per torçe saldimi Ø 1.2-1.6, 5 m</p>
<p><b>790</b></p>	<p><b>890</b></p>	<p><b>1.150</b></p>	<p><b>1.150</b></p>
			
<p><b>GM0610</b> Guajne tefloni per saldım alumini Ø 1.0-1.2, 3 m</p>	<p><b>GM0611</b> Guajne tefloni per saldım alumini Ø 1.0-1.2, 4 m</p>	<p><b>GM0612</b> Guajne tefloni per saldım alumini Ø 1.0-1.2, 5 m</p>	<p><b>GM0760</b> Guajne tefloni per saldım alumini Ø 1.2-1.6, 3 m</p>
<p><b>2.790</b></p>	<p><b>3.490</b></p>	<p><b>3.990</b></p>	<p><b>2.990</b></p>

1  
2  
3  
4  
5  
6  
7  
8  
9  
10



**SC4413-00**  
Torçe saldimi TIG 9V me rregullim manual, gjatesia 4 m, TSKM25-2M

**13.900**



**SF6409-10**  
Torçe saldimi TIG 17 Classic, gjatesia 4 m, TSK 50-M12X1 + KIT aksesoresh

**24.900**



**SK6409-10**  
Torçe saldimi TIG 26 Classic, gjatesia 4 m, TSK 50-M12X2 + KIT aksesoresh

**21.500**



**QB0016**  
Zorre e zeze per torca saldimi 5X8, 100 m

**14.900**



**MF0332**  
Qafe torce saldimi Ergoplus 15, 200 A

**1.490**



**MF0333**  
Qafe torce saldimi Ergoplus 25, 300 A

**2.590**



**MF0033**  
Qafe torce saldimi Ergoplus 25

**3.290**



**MG0110**  
Qafe torce saldimi Ergoline 500, 500 A

**4.900**

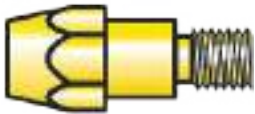

**MD0131-00**  
Adaptor majash saldimi M6, 32 mm

**390**

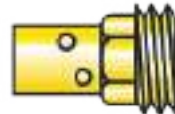

**ME0076**  
Adaptor majash saldimi M8, 25 mm

**330**



**ME0016**  
Difuzor majash saldimi M6, 35 mm

**390**



**FB0117**  
Difuzor majash saldimi 37 mm

**390**

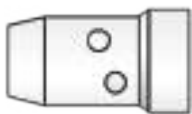

**ME0079**  
Difuzor majash saldimi plastik i bardhe 28 mm

**150**



**ME0579**  
Difuzor majash saldimi qeramike 16 mm

**220**



**ME0517**  
Difuzor majash saldimi qeramike 32 mm

**220**

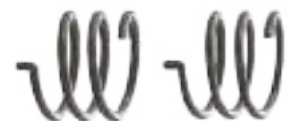

**EA0303/EA0304**  
Suste adaptor majash saldimi per torça 200A/300 A

**220 / 220**



### MAJA TELI M6 PER TORÇA SALDIMI

Kodi	Dimensioni	Cmimi
MD0008-08	Ø 0.8 X 25 mm	<b>99</b>
MD0008-10	Ø 1.0 X 25 mm	<b>99</b>
MD0008-12	Ø 1.2 X 25 mm	<b>79</b>



### MAJA TELI M6 PER TORÇA SALDIMI

Kodi	Dimensioni	Cmimi
MD0009-08	Ø 0.8 X 28 mm	<b>119</b>
MD0009-10	Ø 1.0 X 28 mm	<b>119</b>
MD0009-12	Ø 1.2 X 28 mm	<b>119</b>



### MAJA TELI M8 PER TORÇA SALDIMI

Kodi	Dimensioni	Cmimi
MD0005-08	Ø 0.8 X 30 mm	<b>150</b>
MD0005-10	Ø 1.0 X 30 mm	<b>190</b>
MD0005-12	Ø 1.2 X 30 mm	<b>190</b>
MD0005-82	Ø 1.2 X 30 mm	<b>250</b>



### MAJA TELI M6 PER SALDIM ALUMINI

Kodi	Dimensioni	Cmimi
MD0009-60	Ø 1.0 X 28 mm	<b>119</b>
MD0009-62	Ø 1.2 X 28 mm	<b>99</b>



### HUNDEZ QERAMIKE TIG E SHKURTER

Kodi	Dimensioni	Cmimi
TE0003-24	9 / 20 / 25 - 2.4 mm	<b>190</b>



### HUNDEZ QERAMIKE TIG E GJATE

Kodi	Dimensioni	Cmimi
TD0003-24	9 / 20 / 25 - 2.4 mm	<b>89</b>
TD0001-24	17 / 18 / 26 - 2.4 mm	<b>139</b>
TD0003-16	9 / 20 / 25 - 1.6 mm	<b>99</b>



### HUNDEZ QERAMIKE TIG E SHKURTER CB

Kodi	Dimensioni	Cmimi
PD0063-12	50-CB 70 Ø1,2mm	<b>390</b>



### BEK KONIK PER TORCA SALDIMI

Kodi	Dimensioni	Cmimi
MC0568	Ø16 me kapje te shpejte	<b>690</b>



### HUNDEZ QERAMIKE TIG E GJATE

Kodi	Dimensioni	Cmimi
TC0002	6.4x47 mm, gr.4	<b>149</b>
TC0003	8.0x47 mm, gr.5	<b>149</b>
TC0004	9.8x47 mm, gr.6	<b>149</b>
TC0005	11.2x47 mm, gr.7	<b>149</b>
TC0006	12.7x47 mm, gr.8	<b>149</b>
TC0007	15.7x47 mm, gr.10	<b>220</b>



### HUNDEZ QERAMIKE TIG E SHKURTER

Kodi	Dimensioni	Cmimi
TC0012	6.4x30 mm, gr.4	<b>99</b>
TC0013	8.0x30 mm, gr.5	<b>99</b>
TC0014	9.8x30 mm, gr.6	<b>99</b>
TC0015	11.2x30 mm, gr.7	<b>99</b>
TC0016	12.7x30 mm, gr.8	<b>99</b>
TC0017	15.7x30 mm, gr.10	<b>99</b>





**CX0020**  
Spine saldimi  
TEXAS-TSK  
10-25 mm, Ø 14

**399**



**CX0520**  
Spine saldimi TEXAS-TSK  
25, 10-25 mm, Ø 14  
(e kompletuar)

**450**



**CX0022**  
Spine saldimi  
TEXAS-TSK  
50 mm, Ø 21

**850**



**CX0025**  
Spine saldimi  
TEXAS-TSK  
70 mm, Ø 21

**890**



**CX0524**  
Spine saldimi TEXAS-TSK  
95, 95 mm, Ø 24  
(e kompletuar)

**1.590**



**CX0030**  
Prize saldimi  
TEXAS-TBE  
10-25 mm Ø 21

**450**



**CX0058**  
Prize saldimi  
TEXAS-TBE  
35-70 mm Ø 21

**790**



**CX0059**  
Prize saldimi  
TEXAS-TBE  
70-95 mm Ø 24

**950**



**BW0056**  
Kapak fundor Torce  
TIG i mesem  
17/18/16

**199**



**BW0063**  
Kapak fundor  
Torce TIG i  
gjate 9-20V

**199**



**BW0066**  
Kapak fundor Torce  
TIG i gjate -17/18/26

**199**



**BW0067 / BW0065**  
Kapak fundor Torce  
TIG i shkorter  
17/18/26 57Y02  
/ 9-20/41V33

**169**

**139**



**MC0022**  
Bek konik per  
torca saldimi  
Ø 11.5 / 57 mm

**550**



**MC0018**  
Bek konik per  
torca saldimi  
Ø 12 / 53 mm

**490**



**MC0023**  
Bek konik per  
torca saldimi  
Ø 15 / 53 mm mm

**590**



**MC0027**  
Bek konik per  
torca saldimi  
Ø 16 / 84 mm

**990**



**F11416SL**  
Pince saldimi  
200 A

**950**



**F11406**  
Pince saldimi  
profesionale 200 A,  
doreze kundra  
rreshkitjes

**1.900**



**F11407**  
Pince saldimi  
profesionale 250 A,  
doreze kundra  
rreshkitjes

**2.490**



**F11408**  
Pince saldimi  
profesionale 300 A,  
doreze kundra  
rreshkitjes

**2.790**



**F11409**  
Pince saldimi  
profesionale 400 A,  
doreze kundra  
rreshkitjes

**3.290**



**CAV000081**  
Furce pastrimi per  
skorje saldimi

**350**



**MRS000068**  
Mase saldimi 250 A

**790**



**MRS000057**  
Mase saldimi 300 A

**1.490**



**MRS000060**  
Mase saldimi 500 A

**1.590**

**TIG / WR2**



**TR0022-16**  
Elektrode Tungsteni  
1.6x1.75 mm (10 cope)

**1.900**

**TIG / WR2**



**TR0022-32**  
Elektrode Tungsteni  
3.2x1.75 mm (10 cope)

**4.500**

**TIG / WR2**



**TR0022-40**  
Elektrode Tungsteni  
4.0x1.75 mm (10 cope)

**5.900**



**F10976**  
Syze saldimi me mbrojtese  
anesore, xham transparent  
policarbonate

**490**



**F10976.5**  
Syze saldimi jeshile  
DIN5

**1.690**



**OCC000175**  
Syze saldimi  
317/N

**1.590**

**AUTOMATIKE  
ME FOTOELEMENTE**



**MSC000292**  
Kokore per saldim Sacit  
110x90 mm Lion King

**7.500**

**AUTOMATIKE  
ME FOTOELEMENTE**



**MSC000302**  
Kokore per saldim Sacit  
110x90 mm P950 Turbo

**8.900**



**UTI000544**  
Sprai kundra  
rjedhjes se  
gazit 400 ml

**890**

**XHAM MBROJTES PER KOKORE  
SALDIMI**



Kodi	Dimensioni	Cmimi
LVC000085	50X105 DIN 9	<b>79</b>
LVC000086	50X105 DIN 10	<b>79</b>
LVC000087	50X105 DIN 11	<b>79</b>
LVC000088	50X105 DIN 12	<b>79</b>
LVC000089	50X105 DIN 13	<b>79</b>



Kodi	Dimensioni	Cmimi
LVC000001	75X98 DIN 9	<b>99</b>
LVC000002	75X98 DIN 10	<b>99</b>
LVC000003	75X98 DIN 11	<b>99</b>
LVC000004	75X98 DIN 12	<b>99</b>
LVC000005	75X98 DIN 13	<b>99</b>



**F12152.L**  
Xhakete  
mbrojtese  
gjate saldimit,  
Masa L

**2.590**



**F12154.XL**  
Xhakete  
mbrojtese  
gjate saldimit,  
Masa XL

**2.990**

**LVC000023**  
Xham bazik  
transparent  
90X110

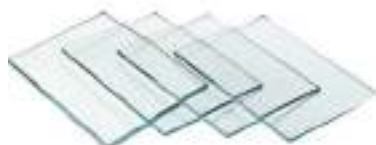

**49**



**F12138**  
Menge lekure  
per saldim,  
qepje me Kevlar

**2.590**



### KABELL STARTERI 200 AMP

**1.190**  
**HBTCP2001**



Ryama  
Gjatesia e kabllit

200 AMP  
3.0 m

### KABELL STARTERI 600 AMP LED



Kodi	Permasa	Çmimi
HBTCP6008	600 AMP - 3.0 m	<b>2.150</b>
HBTCP6008L	600 AMP - 3.0 m + Led	<b>2.490</b>

### MASKE SALDIMI DOREPLASTIKE

**450**  
**HHWM102**



Materiali  
Xhami saldimit

100 % PP  
108 x 50 x 3 mm

### MASKE SALDIMI ME DRITARE PLASTIKE

**550**  
**WM101**



Materiali  
Xhami saldimit

100 % PP  
108 x 50 x 3 mm

### MASKE SALDIMI

**550**  
**WM128**



Materiali  
Xhami i saldimit

100% PP  
110 x 90 x 3 mm

### MASKE SALDIMI ME FOTOELEMENTE DHE MBROJTESE

**2.790**  
**AHM009**



TIG:

### MASKE SALDIMI ME FOTOELEMENTE

**3.900**  
**AHM008**



### MASKE SALDIMI ME FOTOELEMENTE E VERDHE

**5.990**  
**AHM006**



**MASKE SALDIMI ME FOTOELEMENTE**

**E RE**

**2.900**

**WWH3502**

Viewing area:93x43mm

**MASKE SALDIMI ME FOTOELEMENTE**

**E RE**

**4.500**

**WWH3503**

Viewing area:100x60mm

**MASKE SALDIMI ME FOTOELEMENTE**

**E RE**

**1.990**

**WWH2501**

Viewing area:90x35mm

**SYZE SALDIMI ME HAPJE DIN 8**

**E RE**

**190**

**WSG3811**

Materiali PVC

**SYZE SALDIMI ME FOTOELEMENTE**

**E RE**

**1.090**

**WWA1501**

Permasa 194 x 30 mm

**SYZE SALDIMI ME HAPJE**

**250**

**HSGW01**

Materiali PVC  
 Xhama me hapje

**SYZE SALDIMI ME FOTOELEMENTE**

**1.550**

**AMH111**

Permasa ekranit  
 Me bisht plastik 95 x 31mm

**SYZE SALDIMI ME FOTOELEMENTE**

**1.590**

**AHM112**

Permasa ekranit  
 Me llastik 95 x 31mm

**SYZE MBROJTJESE (VETEM PER SALDIM)**

270  
HSG07



Pesha  
Materiali

0.05 kg  
PVC

**DOREZA LEKURE SALDIMI**

990  
HGVM03

**Size:14"** **1Pair/Paper**  
250°C



Permasa  
Temperatura

14"  
250°C

**DOREZA LEKURE SALDIMI**

1.150  
HGVM01



Permasa

14"

**DOREZA LEKURE SALDIMI**

1.150  
HGVM02



Permasa  
Qepje me kevlar

16"

**DOREZA SALDATORI LEKURE**

**ERE**

**Size:16"** **1Pair/Paper**

1.250  
HGVM01



Permasa

QEPJE ME KEVLAR

16"

**DOREZA LEKURE SALDIMI**

**ERE**

**Size:16"** **1Pair/Paper**

1.550  
HGVM04



Permasa  
Temperatura

16"  
350°C

**PERPARESE SALDATORI LEKURE**

**ERE**

**Size:90X60cm**

Thickness:1.1-1.3mm  
Waist Length:  
136cm

2.150  
HGVA01



Ngjyra  
Masa

Gri  
90 x 60 cm

**PERPARESE SALDATORI LEKURE**

**ERE**

**Size:90X60cm**

Thickness:1.1-1.3mm  
Waist Length:  
136cm

2.490  
HGVA03



Ngjyra  
Masa

Portokalli  
90 x 60 cm



**MBULESE MBROJTESE SALDIMI PER SHPATULLAT DHE KRAHET**

**E RE**

**Size:L**  
Thickness:1.1-1.3mm

5.500

HGV0302



Masa

L

**MBULESE SALDIMI PER KOKEN DHE SHPATULLAT**

**E RE**

**Size:one size**  
Thickness:1.1-1.3mm

2.500

HGV0301

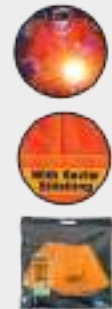

Mase

Standarte  
1.1-1.3mm

**XHAKETE SALDATORI LEKURE**

**E RE**

**Size:L**  
Thickness:1.1-1.3mm

7.500

HGV0303



Materiali

Masa

Lekure

L

**MBAJTESE ELEKTRODE**

650

WAH3008



Rryma saldimit  
Per saldatriçe

300 A  
MMA

**MBAJTESE ELEKTRODE**

850

WAH5008



Rryma saldimit  
Per saldatriçe

500 A  
MMA

**MBAJTESE ELEKTRODE**

850

WAH8008



Rryma saldimit

800 A  
E pershtatshme per saldimit MMA

**MBAJTESE ELEKTRODE**

990

WAH10008



Rryma saldimit

1000 A  
E pershtatshme per saldimit MMA

**PINCE SHTRENGUESE PER SALDIM**

990

HWP0210

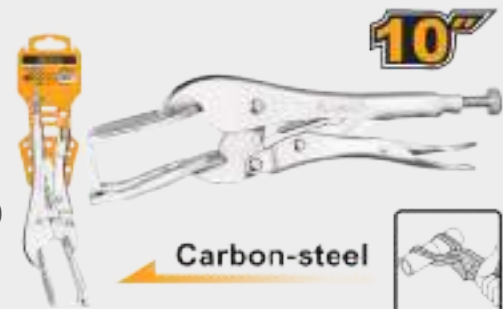

Permasa

10"  
Celik

**KENDORE MAGNETIKE**

**3"**

**350**

AMWH25031



Kendet

3" (45°,90°,135°)

**KENDORE MAGNETIKE**

**4"**

**550**

AMWH50041



Kendet

4" (45°,90°,135°)

**KENDORE MAGNETIKE**

**5"**

**890**

AMWH75051



Kendet

5" (45°,90°,135°)

**KENDORE MAGNETIKE**

**4"**

**550**

AMWH50042



Kendet

4" (30°,45°,60°,75°,90°,105°, 120°,135°,150°)

**SET ME 4 KENDORE MAGNETIKE**

**790**

AMWH4001



Sasia  
Kendet

6 cope  
45 ° / 90 ° / 135 °

**SET ME 6 KENDORE MAGNETIKE**

**990**

AMWH6001



Sasia  
Kendet

6 cope  
45 ° / 90 ° / 135 °

**SET ME 4 KENDORE MAGNETIKE**

**690**

AMWH4062



Permasa

5" (45°,90°,135°)

**SET ME 7 KENDORE MAGNETIKE**

**E RE**

**1.990**

AMWH7002



Permasa

30°,45°,90°,75°,105°,120°,135°



1 2 1 7 S

● **1217S**  
Torçe saldimi  
kit bashke me  
1.5 m tub



**5.900**

1 0 4 4 K I T



● **1044KIT**  
Torçe saldimi kit

**2.650**

1 4 3 1 F



**9.900**

● **1431F**  
Kit kanelle me gas per  
bombel 15 kg Tub 5 m  
E pershtatshme per bombel  
gasi 3-15 Kg  
Rregullatore presion gasi  
Ndezje me çentil

1 0 4 7 G B P



**1.990**

● **1047GBP**  
Dieges bari  
ekologjik



● **121930C** **3.450**  
Torçe saldimi me oksigjen  
25 cm / 30 mm

● **121945M** **3.850**  
Torçe saldimi me oksigjen  
35 cm / 45 mm

● **121960C** **3.950**  
Torçe saldimi me oksigjen  
25 cm / 60 mm

● **121960M** **3.990**  
Torçe saldimi me oksigjen  
45 cm / 60 mm

● **121960L** **4.500**  
Torçe saldimi me  
oksigjen  
60 cm / 60 mm

1 2 1 9 6 0 L P

● **121960LP**  
Torçe bitumi  
me çentil  
100 cm

**7.500**



1 2 1 9 6 0 L T 5 D

● **121960LT5F**  
Torçe saldimi  
bashke me 5 m tub

**7.900**





1 2 1 7



● 1217  
 Torçe saldimi me bombel Butani 2-5 kg

**2.650**

1 0 6 2 E



● 1062E  
 Torçe profesionale saldimi  
 per bombela Kemap dhe Supergas  
 2400°C

**6.900**

1 2 1 8 H 7 5



● 201020A  
 Torçe saldimi me oksijen me  
 maje

**4.800**

1 2 1 7 T K I T S



● 1217TKITSLM  
 Torçe saldimi kit bashke me 5  
 aksesore

**4.500**

1 2 1 7 R



● 1217R  
 Havi Kallaji Profesionale me trup  
 metalik per bombel butani

**4.900**

6 0 2 7



● 6027  
 Torçe saldimi profesionale  
 me 1 kalim

**2.250**

6 0 2 6



● 6026  
 Torçe saldimi profesionale  
 me 2 kalime per bombel Butani

**5.500**

1 0 4 7 S C



● 1047SC  
 Torçe saldimi profesionale  
 per bombela Supergas

**2.500**

1 0 5 0 0



- 10500  
Mikrosaldues me rimbushje

**1.590**

1 0 5 2 1



- 10521  
Aksesore mikrosaldimi per torcen 10500

**1.590**

1 0 5 0 3



- 10503  
Kit zevendesues per mikrosaldues 10500

**1.690**

1 6 1 0



- 1610  
Stacioner saldimi me display dixhitale

**6.900**

2 0 1 0 1 0



- 201010  
Doreze alumini per torce saldimi me oksigjen

**7.900**

1 5 0 0 K I T



- 1500KIT  
Kit pirografie profesional

**3.500**

1 5 1 5



- 1515  
Kit me 6 maja per pirografi

**490**

1 5 0 5



- 1505  
Kit me 7 aksesore per pirografi

**690**

1 2 5 0 1



- 12501  
Kit aksesoresh pastrimi per torçe saldimi

**1.690**

1 6 5 0

6W



- 1650  
Kit per prerjen e polesterolit dhe plastikes

**5.500**

1 7 6 0



- 1760  
Pistoletë ngjitje me kallama plastik me wireless

**3.990**

1 7 4 0

100W



- 1740  
Havi kallajj profesionale 100 Watt

**2.990**

KE 3 0 4 5



- KE3045  
Havi kallajj 30 W

**2.900**

3 0 5 2

60W



- 3052  
Makineri ngjitese plastike 41 - 62 Wat

**5.900**

1 2 1 9 K I T



- 1219KIT  
Kit havi kallajj profi bashke me aksesore

**9.900**

3 0 3 0 N / 3 0 3 5 N

520°C 120W LONG LIFE TIP 200 g



- 3030N  
Havi kallajj Profi. me maje pllake 120 W  
**5.500**

520°C 180W LONG LIFE TIP 210 g

- 3035N  
Havi kallajj profesionale pete 180 W / 210 gr  
**5.900**

3 0 4 0 N

520°C 250W LONG LIFE TIP 310 g



- 3040N  
Havi kallajj profesionale pete 250 Watt 310 gr  
**6.900**





**1600**  
Havi kallaji profesionale me rregullim fuqie stacioner 0-48W

**4.990**

48W  
SPTC

**170060** 1.550  
Havi kallaj 40 W bashke me 2 maja

**170090** 1.900  
Havi kallaj 80 W bashke me 2 maja

**170080** 1.750  
Havi kallaj 60 W bashke me 2 maja

**170100** 2.650  
Havi kallaj 100 W bashke me 2 maja

170011

**170011** 1.490  
Kit aksesoresh per pune te imta

**L090PASNE1** 490  
Paste kallaji 100 gr

**L090PASNE2** 950  
Paste kallaji 250 gr

**L070BS5AC0** 450  
Tel kallaji 20 gr

**L070BS5AC1** 1.790  
Tel kallaji 100 gr

**B070BS5AC1** 1.990  
Tel kallaji 50% kallaji 1.5 mm 100 gr

**170060P** 490  
Maja per havi kallaj 40W

**170090P** 990  
Maja per havi kallaj 80W

**170080P** 550  
Maja per havi kallaj 60W

**170100P** 1.690  
Maja per havi kallaj 100W

40W SPTC  
60W SPTC  
80W SPTC  
100W SPTC

1741B

**1741B** 490  
Kit majash per havi kallaji

**L070BS5AC2** 3.790  
Tel kallaji 250 gr

**B070BS5AC2** 3.790  
Tel kallaji 250 gr



5 9 9 0 2



6 cope  
50 cm

**59902 1.150**  
Shufra saldimi  
bronzi me oksigjen

5 9 9 0



24 cope  
50 cm

**5990 1.250**  
Shufra saldimi  
hekuri me oksigjen

5 9 9 1



10 cope  
50 cm

**5991 950**  
Shufra saldimi  
celiku me oksigjen

5 9 9 2



6 cope  
50 cm

**5992 990**  
Shufra saldimi  
tunxhi me oksigjen

5 9 9 3



6 cope  
50 cm

**5993 1.990**  
Shufra saldimi  
argjendi me oksigjen

5 9 9 4



6 cope  
50 cm

**5994 1.250**  
Shufra saldimi  
bakri me oksigjen

1 7 0 3 1 2 K



**170312K 1.790**  
Regullator presioni 1 - 4 bar  
per bomula GPL

2 0 3 0 5 1



**203051 8.900**  
Reduktor bombela acetileni  
me dy manometra dhe valvul  
sigurie te instaluar

5 2 1



**521 3.900**  
Reduktor oksigjeni me  
valvul sigurie te integruar

5 0 7 E



**507E 3.900**  
Reduktor gasi me valvul  
sigurie te integruar

1 0 4 8 D



**1048D 1.490**  
Mikro torçe me  
rimbushje

1 0 4 9 D



**1049D 390**  
Ndezës gasi me qafe  
te drejte

1 0 4 9 D F



**1049DF 490**  
Ndezës gasi me qafe  
te perkulshme

2 0 3 0 8 5



**203085 270**  
Ndezës gasi ne forme  
kupe



**5 8 0 S M I N I**

**750**
**580SMINI**  
Bombel gazi 110 MI

**5 8 0**

**580 950**
**580**  
Bombel gasi  
Novacet 600 MI

**5 8 1**

**581 1.690**
**581**  
Bombel Kemap  
385 gr

**5 7 5**

**575 650**
**575**  
Bombel Supergas  
330 gr

**1 0 0 5 1**

**10051 350**  
Bombel gasi  
me 6 adaptore  
per rimbushje 90 gr

**5 7 7**

**490**

Bombel rezerve  
gasi 227 gr

**1 7 2 6**

**890**

Spray per sinjalizimin e  
rrjedhjeve te gazit

**1 1 2 0 S 1**

**250**

Bombel gasi tradicionale  
butan 190 gr

**5 7 3**

**6.900**

Bombel me helium per  
mbushje tullumbacesh

**2 0 1 0 0 3 F P**

**69.000**
**201003FP**  
Kit saldimi oksigjen - acitilen  
i kompletuar 3200°C

**5 8 5 H 2 0 0**

**9.900**
**585H200**  
Bombul oksigjeni me rimbushje  
kapaciteti 200 lt

**L 0 7 5 0 1 0 9 9 5**

**9.500**
**L075010995**  
Kit me 4 lingota kallaji 99.9%  
kallaj (1Kg)

**L 0 7 4 0 S N 5 0 3**

**3.900**
**Kit me 2 lingota kallaji**  
50% kallaj (50 gr)

**201151A**  
Maje prerese me  
oksigen 10 mm

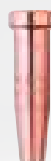
**1.390**

**201153A**  
Maje prerese me  
oksigen 50 mm

**1.390**

**1741BPRO**  
Maje rezerve per  
havvine 1740PRO

**590**

**201121A**  
MAje saldimi  
225 l/ore

**990**



**TOP LINE 1040 A**



**4.500**



- 1040A  
Torçe saldimi me ndezje automatike  
me bombel butani & çentil, 360°



**TORNADO METAL 770**



**3.500**



- 770  
Torçe saldimi me trup metalik  
me bombela butani & çentil

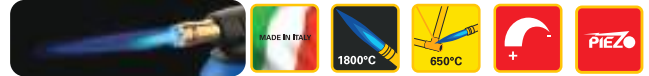

**KE 2018**



**2.550**



- KE2018  
Torçe saldimi me bombel butar



**KE 2018 SETS**



**3.690**



- KE2018SETS  
Torçe saldimi me ndalim gasi automatik,  
Kit bashke me 4 bombela



**1 2 1 7 C**



**5.900**



- 1217C  
Kit saldimi Torçe  
+ bombel  
+ 1.5 m Tub



**8 2 0 A K I T**



**4.900**



- KIT SALDIMI 360°  
Torçe saldimi që punon edhe  
me kokë poshtë me ndezje  
automatike. Temp. e flakës 1900° C



**1 0 4 7**

**2.990**

- 1047  
Torçe saldimi  
profesionale.  
Temperatura  
maksimale e flakës  
1900° C



**1 0 4 7 S E T**

**3.950**

- 1047SET  
Torçe saldimi  
kit bashke me 3 bombela





Ajerngrohese 1600 W  
**HL 1620 S**



**5.500**

Kodi	351106
Fuqia	1600 W
Temperatura	300 - 500 °C

Ajerngrohese 1800 W  
**HL 1820 S**



**7.500**

Kodi	033316
Fuqia	1800 W
Temperatura	50 - 600 °C

Ajerngrohese 2200 W  
**HL 2020 E**



**12.900**

Kodi	SN008192
Fuqia	2200 W
Temperatura	80 - 630 °C

Ajerngrohese 2300 W  
**HG 2320 E, EKTRAN LCD**



**17.900**

Kodi	007386
Fuqia	2300 W
Temperatura	49 - 650 °C

Ajerngrohese 2200 W  
**HG 2220 E horizontale**



**17.500**

Kodi	351700
Fuqia	2200 W
Temperatura	80 - 630 °C

Ajerngrohese 2200 W  
**HG 2420 E industriale**



**21.500**

Kodi	008284
Fuqia	2200 W
Temperatura	80 - 650 °C

Pistoletë per ngjitje 40 W  
**Gluefix**



**2.990**

Kodi	333911
Fuqia	40 W
Temperatura	200 - 200 °C
Pikimi	13 gr/min

Kallama plastik te bardhe per ngjitjen e plastikes dhe PVC



**690**

Kodi 073114

Sasia 26 cope

Kallama plastik te bardhe per ngjitjen e plastikes dhe PP



**690**

Kodi 073411

Sasia 43 cope

Kallama plastik te zi per ngjitjen e plastikes dhe ABS



**990**

Kodi 074210

Sasia 37 cope

Kallama plastik te zi per ngjitjen e plastikes dhe HDPE



**690**

Kodi 071219

Sasia 37 cope

Set me instrumenta per perpunimin e plastikes se shkrire



**1.490**

Kodi 010317

Adaptor ajerngrohesje per ngjitje parakolpesh



009106  
**1.790**

075316  
**1.790**

Kodi 009106 / 075316

Masa 3 mm

Masa 5 mm

Reduktor ajri per ajerngroheset 50 mm



**890**

Kodi 070113

Masa 50 mm

Reduktor ajri per ajerngroheset 6 mm



**990**

Kodi 009571

Masa 6 mm

Reduktor ajri per ajerngroheset 60 mm



**890**

Kodi 070212

Masa 60 mm





**KOMPRESORË AJRI  
DHE AKSESORË**

**AB 100-268 MC**  
KOMPRESOR MONOFAZE



INDUSTRIAL

**59.900**

Depozite 100 L 2HP 230 V / 50 HZ 10 Bar

100%  
MADE IN ITALY

Modeli	Kodi										LxPxH				
		I	l/min	CFM	m <sup>3</sup> /h	bar	psi	HP	KW	grup	Cil St	min-1	dB-(A)	mm	Kg
AB 100-268 MC	1121430238	100	250	8.8	15	10	145	2.0	1.5	AB 268	2/1	1240	72	110x400x830	62

**AB 100/360 MC**  
KOMPRESOR MONOFAZE



INDUSTRIAL

**69.900**

Depozite 100 L 3HP 230 V / 50 HZ 10 Bar

100%  
MADE IN ITALY

Modeli	Kodi										LxPxH				
		I	l/min	CFM	m <sup>3</sup> /h	bar	psi	HP	KW	grup	Cil St	min-1	dB-(A)	mm	Kg
AB 100/360 MC	4116026984	100	270	9.5	15	10	145	3	2.2	AB 360	2/1	1000	72	110x400x830	64

**AB 200-360 MC**  
KOMPRESOR MONOFAZE



INDUSTRIAL

**95.900**

Depozite 200 L 3HP 230 V / 50 HZ 10 Bar

100%  
MADE IN ITALY

Modeli	Kodi										LxPxH				
		I	l/min	CFM	m <sup>3</sup> /h	bar	psi	HP	KW	grup	Cil St	min-1	dB-(A)	mm	Kg
AB 200-360 MC	4116026994	200	350	1248	21	10	145	3	2.2	AB 360	2/1	1500	74	1460x640x1140	

**AB 200-360 TC**  
KOMPRESOR TREFAZOR



INDUSTRIAL

**99.900**

Depozite 200 L 3HP 400 V / 50 HZ 10 Bar

100%  
MADE IN ITALY

Modeli	Kodi										LxPxH				
		I	l/min	CFM	m <sup>3</sup> /h	bar	psi	HP	KW	grup	Cil St	min-1	dB-(A)	mm	Kg
AB 200-360 TC	1121480896	200	350	12.4	21	10	145	3	2.2	AB 360	2/1	1500	74	1460x640x1140	



**AB 300-360 MC**  
KOMPRESOR TREFAZOR



INDUSTRIAL

**125.000**

Depozite 270L 3HP 400 V / 50 HZ 10 Bar

100%  
MADE IN ITALY

Modeli	Kodi										LxPxH					
		I	l/min	CFM	m³/h	bar	psi	HP	KW	grup	Cil	St	min-1	dB-(A)	mm	Kg
AB 300-360 MC	1121480949	270	360	12.4	21	10	145	3	2.2	AB 360	2/1	1450	77	1600X560x1040	134	

**AB 500-525 TF + T**  
KOMPRESOR TREFAZOR



INDUSTRIAL

**199.000**

Depozite 500L 5.5H P 400 V / 50 HZ 10 Bar

100%  
MADE IN ITALY

Modeli	Kodi										LxPxH					
		I	l/min	CFM	m³/h	bar	psi	HP	KW	grup	Cil	St	min-1	dB-(A)	mm	Kg
AB 500-525TF+T	1121540607	500	490	17.3	29.4	10	145	5.5	4	AB 525	2/2	1440	81	1970X590X1300	205	

**AB 505/808 V**  
KOMPRESOR TREFAZOR



INDUSTRIAL

**225.000**

Depozite 500L 7.5HP 400 V / 50 HZ 10 Bar

100%  
MADE IN ITALY

Modeli	Kodi										LxPxH					
		I	l/min	CFM	m³/h	bar	psi	HP	KW	grup	Cil	St	min-1	dB-(A)	mm	Kg
AB 505/808 V	1121550864	500	800	29.3	50	10	145	7.5	5.5	AB 808	2/2	1280	76	1970X590X1300	208	

**AB 500-998 TF + T**  
KOMPRESOR TREFAZOR



INDUSTRIAL

**245.000**

Depozite 500L 10HP 400 V / 50 HZ 10 Bar

100%  
MADE IN ITALY

Modeli	Kodi										LxPxH					
		I	l/min	CFM	m³/h	bar	psi	HP	KW	grup	Cil	St	min-1	dB-(A)	mm	Kg
AB 500-998 TF +T	1121530155	500	1070	37.8	64.2	10	145	10	7.5	AB 998	2/2	1270	78	1970X590X1300	260	



## KOMPRESOR MURI SILENCIOZ ME KARRUKULL 10M



**19.900**

Modeli	Kodi					
Wall Air	1129740370	160	160 l/min	8 bar / 1.5 hp	1.1 kw	8.2 lb

## GRUPE DHE ELEKTROMOTORE PER KOMPRESORE

### GRUP KOMPRESORI



### ELEKTROMOTORE MONOFAZE / TREFAZOR



Kodi	Modeli	Fuqia / Presioni	Cmimi
1123021001	AB268	2.0 HP	<b>25.900</b>
1123021002	AB360	3.0 HP	<b>26.900</b>
1123020504	AB415	4.0 HP	<b>39.900</b>
1123021005	AB 525	5.5 HP	<b>53.900</b>
1123020556	AB 808	7.5 HP/10 bar	<b>109.900</b>

Kodi	Modeli	Fuqia / Presioni	Cmimi
1127380486	HP2 Monofaze	2.0 KF / 230 V	<b>15.500</b>
1127380140	HP3 Monofaze	3.0 KF / 230 V	<b>27.500</b>
1127380343	HP2 Monofaze	2.0 KF / 400 V	<b>14.900</b>
1127380001	HP3 Trefazor	3.0 KF / 400 V	<b>27.500</b>
1127380005	HP4 Trefazor	4.0 KF / 400 V	<b>39.900</b>
1127380068	HP5.5 Trefazor	5.5 KF / 400 V	<b>32.500</b>



**14.900**

### KOMPRESOR AJRI 24 LT

Kodi	FO24
Depozita	24 LT
Fuqia	2 HP / 230 V
Presioni	8 Bar



**16.900**

### KOMPRESOR AJRI 50 LT

Kodi	FO50
Depozita	50 LT
Fuqia	2 HP / 230 V
Presioni	8 Bar

**KOMPRESOR AJRI ME VAJ**

**43.900**

**44.900**
**KOMPRESOR AJRI 100 LT**

Kodi	FO100
Depozita	24 LT
Fuqia	2 HP / 230 V
Presioni	8 Bar

**KOMPRESOR AJRI DOPIO PISTON 100 LT**

Kodi	FOV100
Depozita	100 LT
Fuqia	3 HP / 230 V / 50 HZ
Presioni	8 Bar

**65.000**

**69.000**
**KOMPRESOR AJRI 200 LT**

Kodi	FO200
Depozita	200 Lt
Fuqia	2 HP / 230 V
Presioni	8 bar

**KOMPRESOR AJRI 200 LT TREFAZOR**

Kodi	FO200-4HP
Depozita	200 Lt
Fuqia	4 HP / 380 V
Presioni	10 bar

**115.000**

**145.000**
**KOMPRESOR AJRI 300 LT TREFAZOR**

Kodi	FO300-4HP
Depozita	300 L
Fuqia	4 HP / 380 V
Presioni	10 bar

**KOMPRESOR AJRI 500 LT TREFAZOR**

Kodi	FO500-5.5HP
Depozita	500 Lt
Fuqia	5.5 HP / 380 V
Presioni	10 bar

## KOMPRESOR AJRI PA VAJ

**15.900**

**19.900**

### KOMPRESOR AJRI SILENCIOZ PA VAJ 24 LT

Kodi	FOS24
Depozita	24 L
Fuqia	2 HP / 230 V
Presioni	7 Bar

### KOMPRESOR AJRI SILENCIOZ PA VAJ 50 LT

Kodi	FOS50
Depozita	50 L
Fuqia	2 HP / 230 V
Presioni	7 Bar



### GRUP KOMPRESORI

Kodi	Per kompresor	Cmimi
FOG2450	24 / 50 L	<b>11.500</b>

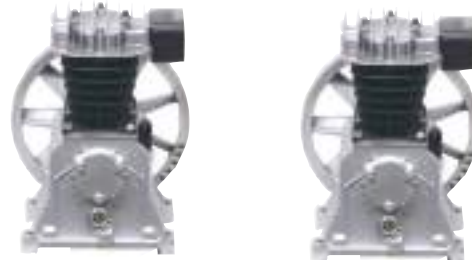

### GRUP KOMPRESORI

Kodi	Per kompresor	Cmimi
FOG100	100 L	<b>12.900</b>
FOG200	200L	<b>14.900</b>

**2HP**

**3HP**

### ELEKTROMOTOR KOMPRESORI

Kodi	Fuqia	Cmimi
FOM100	2 HP	<b>9.900</b>

### ELEKTROMOTOR KOMPRESORI

Kodi	Fuqia	Cmimi
FOM200	3 HP	<b>18.900</b>



### KONDRVALVUL PER KOMPRESOR 24 L / 50 L FO50

Kodi	Depozita	Cmimi
FO50P-4	24 / 50 L	<b>290</b>



### PRESOSTAT MONOFAZE ME 4 DALJE

Kodi	Depozita	Cmimi
FO200P-11	FO200	<b>950</b>



### MANOMETER AJRI

Kodi	Depozita	Cmimi
FO200P-12	200L	<b>450</b>



**KOMPRESOR SILENCIOZ PA VAJ**

1.1kW(1.5HP) **6L**

**11.900**

ACS111062



Depozita 6 L  
 Fuqia 1.5 HP  
 Presioni 8 Bar

**KOMPRESOR SILENCIOZ PA VAJ**

1.1kW(1.5HP) **15L**

**12.900**

ACS111152



Depozita 15 L  
 Fuqia 1.5 HP  
 Presioni 8 Bar

**KOMPRESOR MONOFAZE SILENCIOZ PA VAJ**

 600W(0.8HP) **24L**

**14.900**

ACS175241



Depozita 24 L  
 Fuqia 1.6 HP  
 Presioni 8 Bar

**KOMPRESOR MONOFAZE SILENCIOZ PA VAJ**

1.2kW(1.6HP) **50L**

**19.900**

ACS112501



Depozita 50 L  
 Fuqia 1.6 HP  
 Presioni 8 Bar

**KOMPRESOR MONOFAZE SILENCIOZ PA VAJ ME 2 MOTORA**

**50L**

**29.900**

ACS224501



Depozita 50 L  
 Fuqia 3.2 HP  
 Presioni 8 Bar

**KOMPRESOR MONOFAZE SILENCIOZ PA VAJ ME 2 MOTORA**

2.4kW(3.2HP) **100L**

**39.900**

ACS2241001



Depozita 100 L  
 Fuqia 3.2 HP  
 Presioni 8 Bar

**KOMPRESOR MONOFAZE SILENCIOZ PA VAJ ME 3 MOTORA**

**IRI**

3.6kW(4.8HP) **100L**

**59.900**

ACS3361001



Depozita 100 L  
 Fuqia 4.8 HP  
 Presioni 8 Bar

**KOMPRESOR MONOFAZE SILENCIOZ PA VAJ ME 4 MOTORA**

4.8kW(6.4HP) **150L**

**69.900**

ACS4481501



Depozita 150 L  
 Fuqia 6.4 HP  
 Presioni 8 Bar

1  
2  
3  
4  
5  
6  
7  
8  
9  
10

### KOMPRESOR 24 L

1.5kW(2.0HP) **24L**

**12.900**

AC202411



Depozita 24L  
Fuqia 2HP / 1.5 kW / Monofaze  
Presioni 8 Bar

### KOMPRESOR 50 L

1.8kW(2.5HP) **50L**

**13.900**

AC255011



Depozita 50L  
Fuqia 2.0HP / 1.8 kW / Monofaze  
Presioni 8 Bar

### KOMPRESOR MONOFAZE

2.2kW(3.0HP) **100L**

**49.900**

AC301008



Depozita 100 LT  
Fuqia 2.2 kW/3 HP  
Presioni 8 Bar

### KOMPRESOR MONOFAZE ME RRIPI

3.0kW(4.0HP) **200L**

**69.900**

AC402001



Depozita 200 L  
Fuqia 3.0 Kw / 4 HP

### KOMPRESOR TREFAZOR ME RRIPI

4.1kW(5.5HP) **300L**

**99.900**

AC553001



Depozita 300 L  
Fuqia 4.1 Kw / 5.5

### KOMPRESOR TREFAZOR ME RRIPI

5.5kW(7.5HP) **500L**

**149.000**

AC755001



Depozita 500 L  
Fuqia 5.5 Kw / 7.5 HP

### KOMPRESOR AJRI MAKINE

**3.500**

AAC1408



Ryma 10 A  
Tensioni 12 V  
Prurje 35 l/min

### KOMPRESOR MAKINE + AKSESORE

**4.900**

AAC1601



Prurje 35 L / min  
Tensioni 12 V  
Presioni 11 Bar

## KARRUKULL AJRI

**ERE**

Dizajn kompak dhe i lehte

Poliuretan

Gjatesi te ndryshme tubi

Pajisje te ndryshme



### KARRUKULL AJRI 3/8" / KARRUKULL AJRI 1/2"

Kodi	Tubi	Çmimi
AT101415-1	3/8" - 15 m + 1.5 m - 10x14.5 mm	<b>18.900</b>
AT121615-1	1/2" - 15 m + 1.5 m - 12x16 mm	<b>24.900</b>

### Rakorderi e shpejte gjigande (M)

**ERE**



Kodi	Permasa		Çmimi
ABM/1	3/8"	10	<b>3.900</b>
ABM/2	1/2"	10	<b>3.990</b>

### Rakorderi e shpejte gjigande (F)

**ERE**



Kodi	Permasa		Çmimi
ABM/A1	3/8"	10	<b>3.900</b>
ABM/A2	1/2"	10	<b>3.990</b>



### Rakorderi e shpejte gjigande per tub gome

**ERE**



Kodi	Permasa		Çmimi
4100/B1	10x19	10	<b>1.390</b>
4100/B2	13x23	10	<b>1.490</b>

### Rakorderi e shpejte gjigande femer

**ERE**



Kodi	Permasa		Çmimi
4000/B1	10x19	10	<b>2.590</b>
4000/B2	13x23	10	<b>2.790</b>

### Rakorderi gjigande bajonete filetimit mashkull

**ERE**



Kodi	Permasa		Çmimi
4100/1	3/8"	10	<b>490</b>
4100/2	1/2"	10	<b>590</b>

### Rakorderi gjigande me bajonete per tub gome

**ERE**



Kodi	Permasa		Çmimi
23/B9	10x19mm	10	<b>450</b>



**Rubinet me kapje 1/4 M dhe kapje me dado te frezuar**



Kodi	Permasa		Çmimi
RBL/2	1/4 M	1	<b>490</b>

**Reduktor presioni me kapje 1/4 F**



Kodi	Presioni	Çmimi
RP172	0-8 bar	<b>1.350</b>

**Rubinet presioni me kapje 1/4 F + rubinet me dado te frezuar**



Kodi	Presioni	Çmimi
RP172L	0-8 bar	<b>1.790</b>

**Reduktor presioni me manometer me 1 dalje 1/4 F me rubinete**



Kodi	Presioni	Çmimi
RP182	12 bar	<b>1.990</b>

**Reduktor presioni me manometer me 1 dalje universale**



Kodi	Presioni	Çmimi
RP182R	12 bar	<b>2.500</b>

**Reduktor presioni 3/8 me 2 dalje me rubinet**



Kodi	Presioni	Çmimi
RPF187	12 bar	<b>3.500</b>

**Reduktor presioni 3/8 me 2 dalje universale**



Kodi	Presioni	Çmimi
RPF187R	12 bar	<b>3.500</b>

**Reduktor presioni 1/2 me 2 dalje me rubinet**



Kodi	Presioni	Çmimi
RPF188	12 bar	<b>4.500</b>

**Reduktor presioni 1/2 me 2 dalje universale**



Kodi	Presioni	Çmimi
RPF188R	12 bar	<b>4.500</b>

**Filter uji per kompresor 3/8**



Kodi	Presioni	Çmimi
FR180	12 bar	<b>4.500</b>

**Filter uji per kompresor 1/2**

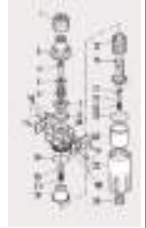

Kodi	Presioni	Çmimi
FR2001/2	16 bar	<b>5.900</b>

**Grup filter uji + rregullator + oilator 1/4**



Kodi	Presioni	Çmimi
FRL180	12 bar	<b>7.500</b>

**Grup filter uji + rregullator + oilator 1/2**



Kodi	Presioni	Çmimi
FRL2001/2	16 bar	<b>9.900</b>

**Lubrifikator vaji me mikrosprucim kapaciteti gotes 40 ml**

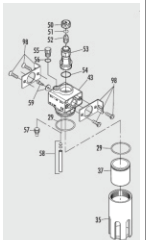

Kodi	Presioni	Çmimi
L180	12 bar	<b>3.500</b>

**Lubrifikator vaji me mikrosprucim kapaciteti gotes 170 ml**

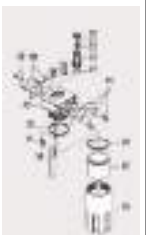

Kodi	Presioni	Çmimi
L2001/2	16 bar	<b>4.500</b>



### Valvul universale me kapje M

Kodi	Kapja	L	D	L1		Çmimi
112/1	1/4M	46	22	9	10	<b>550</b>
112/2	3/8M	47.5	22	9	10	<b>590</b>
112/3	1/2M	48.5	22	10.5	10	<b>650</b>



### Valvul universale me kapje F

Kodi	Kapja	L	D	L1		Çmimi
112/A1	1/4F	52.5	22	11	10	<b>610</b>
112/A2	3/8F	52.5	22	12	10	<b>630</b>



### Valvul universale per tub gome

Kodi	Kapja	L	D	L1		Çmimi
112/B3	6X14	70	22	19	10	<b>750</b>
112/B6	8X17	70.5	22	19	10	<b>850</b>
112/B9	10X19	70.5	22	19	10	<b>890</b>



### Valvul universale per tub

Kodi	Kapja	L	D	L1		Çmimi
112/C1	6	64	22	20	10	<b>690</b>
112/C2	8	64	22	20	10	<b>690</b>
112/C3	10	64	22	20	10	<b>690</b>



### Valvul universale me suste per tub spiral

Kodi	Kapja	L	D	L1		Çmimi
112/D1	4X6	64	22	20	10	<b>690</b>
112/D2	6X8	64	22	20	10	<b>750</b>
112/D3	8X10	64	22	20	10	<b>750</b>



### Bajonete Gjermane me kapje (M)

Kodi	Kapja		Çmimi
113/1	1/4M	10	<b>160</b>
113/2	3/8M	10	<b>190</b>
113/3	1/2M	10	<b>250</b>



### Bajonete Gjermane me kapje (F)

Kodi	Kapja		Çmimi
113/A1	1/4F	10	<b>190</b>
113/A2	3/8F	10	<b>210</b>
113/A3	1/2F	10	<b>290</b>



### Bajonete Gjermane per tub

Kodi	Kapja		Çmimi
113/B3	6X14	10	<b>290</b>
113/B6	8X17	10	<b>390</b>
113/B9	10X19	10	<b>390</b>



### Bajonete Gjermane per tub

Kodi	Kapja		Çmimi
113/C1	6	10	<b>190</b>
113/C2	8	10	<b>190</b>
113/C3	10	10	<b>190</b>
113/C4	12	10	<b>250</b>



### Bajonete Gjermane me suste per tub spiral

Kodi	Kapja		Çmimi
113/D3	6X8	10	<b>290</b>
113/D4	8X10	10	<b>390</b>
113/D7	10X12	10	<b>450</b>



### Bashkues i drejte per tub



Kodi	Permasa		Çmimi
46/C1	6	10	<b>99</b>
46/C2	8	10	<b>120</b>
46/C3	10	10	<b>160</b>
46/C4	12	10	<b>220</b>

### Rakorderi me kapje me gomine per tub



Kodi	Kapja		Çmimi
46/F1	6	10	<b>110</b>
46/F2	8	10	<b>110</b>
46/F3	10	10	<b>110</b>

### Rakorderi me fileto (F) per tub



Kodi	A	L	I		Çmimi
1227/1	1/4	34	20	10	<b>170</b>
1227/2	1/4	34	20	10	<b>170</b>
1227/3	1/4	34	22	10	<b>170</b>

### Rakorderi me fileto (M) per tub



Kodi	A	L	I		Çmimi
1233/1	1/8	31.35	20	10	<b>110</b>
1233/2	1/4	36	20	10	<b>150</b>
1233/3	1/8	31.5	20	10	<b>120</b>
1233/4	1/4	36	20	10	<b>150</b>
1233/5	3/8	36.5	20	10	<b>190</b>
1233/6	3/8	36.5	20	10	<b>190</b>
1233/7	1/2	39	20	10	<b>320</b>
1233/8	1/4	35	20	10	<b>160</b>
1233/11	1/4	38	22	10	<b>160</b>
1233/14	3/8	38.5	22	10	<b>230</b>
1233/15	1/2	39	20	10	<b>290</b>
1233/16	1/2	41	22	10	<b>320</b>

### Manikote (F)(F)

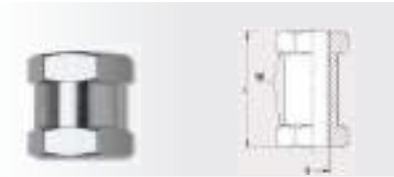

Kodi	B	L	SW	Çmimi
1225/2	1/8	15	13	100
1225/3	1/4	22	16	145
1225/4	3/8	24	20	225
1225/5	1/2	27	25	390

### Manikote reduktuese (F)(F)

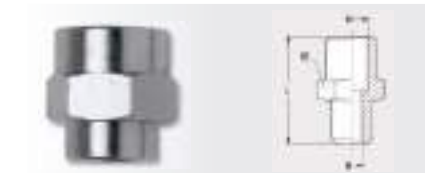

Kodi	B1	B2	L	Çmimi
1226/2	1/8	1/4	19/5	10
1226/3	1/8	3/8	20	10
1226/4	1/8	1/2	23/5	10
1226/5	1/4	3/8	23	10
1226/6	1/4	1/2	27	10
1226/7	3/8	1/2	27/5	10

### Nipel reduktuese (M)(M)

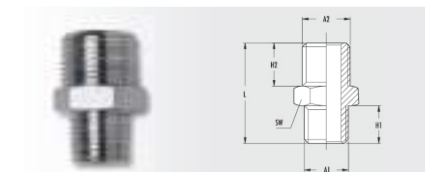

Kodi	A	B	L	Çmimi
1220/1	1/8	1/4	23.5	10
1220/2	1/8	3/8	24	10
1220/3	1/4	3/8	27	10
1220/4	1/4	1/2	30.5	10
1220/5	3/8	1/2	31	10

### Nipel (M)(M)



Kodi	A	B	L	Çmimi
1219/1	1/8	7.5	19.5	10
1219/2	1/4	11	27	10
1219/3	3/8	11.5	28	10
1219/4	1/2	14	33.5	10

### Reduktor (M)(F)



Kodi	A	B	H	L	Çmimi
1215/1	1/8	1/8	7/5	17.5	10
1215/2	1/8	1/4	7/5	21.5	10
1215/3	1/8	3/8	7/5	22	10
1215/4	1/4	1/4	11	25	10
1215/5	1/4	3/8	11	25.5	10
1215/6	1/4	1/2	11	29	10
1215/7	3/8	3/8	11.5	26	10
1215/8	3/8	1/2	11.5	29.5	10
1215/9	1/2	1/2	14	32	10

### Reduktor (M)(F)

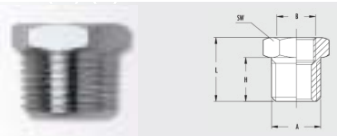

Kodi	A	B	H	L	Çmimi
1217/1	1/4	1/8	11	16	10
1217/2	3/8	1/8	11.5	16.5	10
1217/3	1/2	1/8	14	19.5	10
1217/4	3/8	1/4	11.5	16.5	10
1217/5	1/2	1/4	14	19.5	10
1217/6	1/2	3/8	14	19.5	10

### Tapë fundore e jashtme(M)



Kodi	A	B	L	Çmimi
1223/2	1/8	6	10.5	10
1223/3	1/4	8	13	10
1223/4	3/8	9	14	10
1223/5	1/2	10	15.5	10

### Rakorderi L (M)(M)



Kodi	A	C	SW	Çmimi
1255/1	1/8	18.5	8	10
1255/2	1/4	22	13	10
1255/3	3/8	26.5	17	10
1255/4	1/2	33	20	10

### Rakorderi L (M)(F)

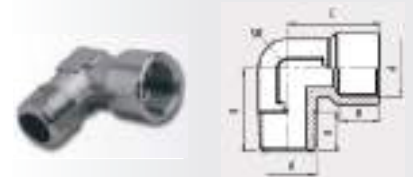

Kodi	A	C	L	Çmimi
1250/1	1/8	18.5	8	10
1250/2	1/4	22	13	10
1250/3	3/8	26.5	17	10
1250/4	1/2	30.5	20	10

### Rakorderi L (F)(F)



Kodi	A	C	SW	Çmimi
1249/1	1/8	18.5	8	10
1249/2	1/4	22	13	10
1249/3	3/8	26.5	17	10
1249/4	1/2	33	20	10

### Rakorderi T (F)(F)(F)

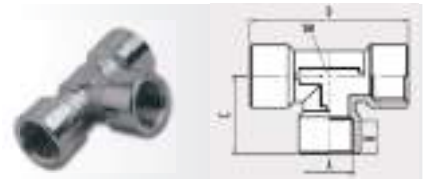

Kodi	A	C	SW	Çmimi
1251/1	1/8	18.5	8	10
1251/2	1/4	22	13	10
1251/3	3/8	26.5	17	10
1251/4	1/2	33	20	10

### Rakorderi T (F)(M)(F)



Kodi	A	C	SW	Çmimi
1252/1	1/8	18.5	8	10
1252/2	1/4	22	13	10
1252/3	3/8	26.5	17	10
1252/4	1/2	33	20	10



### Rakorderi Y (M)(F)(F)

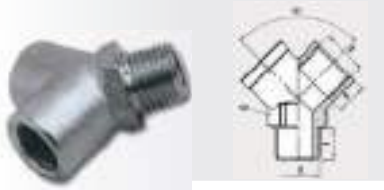

Kodi	A	C	SW		Çmimi
1260/2	1/4	11	17	10	<b>350</b>
1260/3	3/8	11.5	20	10	<b>650</b>
1260/4	1/2	21.4	25	10	<b>950</b>

### Rakorderi Y (F)(F)(F)

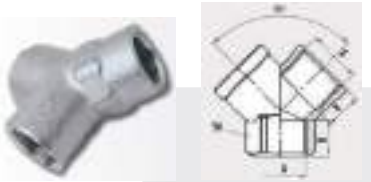

Kodi	A	C	SW		Çmimi
1261/2	1/4	11	17	10	<b>350</b>
1261/3	3/8	11.5	20	10	<b>590</b>
1261/4	1/2	21.4	25	10	<b>890</b>

### Rakorderi me kapje me gomine per tub gome



Kodi	Permasa		Çmimi
46/A2	6X14	10	<b>270</b>
46/A5	8X17	10	<b>290</b>

### Rakorderi me kapje 1/4 M dhe dado te frezuar



Kodi	Permasa		Çmimi
47/A1	1/4 M	10	<b>180</b>

### Rakorderi me kapje 1/4 M dhe kapje me gomine



Kodi	Permasa		Çmimi
47/B1	1/4 M	10	<b>180</b>

### Rakorderi e drejte per tub najloni



Kodi	Permasa		Çmimi
RM6030/3	6 MM	10	<b>350</b>
RM6030/4	8 MM	10	<b>390</b>
RM6030/5	10 MM	10	<b>450</b>

### Rakorderi e drejte per tub najloni 8 mm me kapje 1/8"



Kodi	Permasa		Çmimi
RR6033/7	8 mm	10	<b>250</b>

### Rakorderi e drejte bashkuese per tub najloni



Kodi	L	D	H		Çmimi
RR6030/1	26	10	12.5	10	<b>290</b>
RR6030/3	28	12	13.5	10	<b>320</b>
RR6030/4	33	15	16	10	<b>350</b>
RR6030/5	35.5	18	17	10	<b>390</b>
RR6030/6	41	20	19	10	<b>590</b>

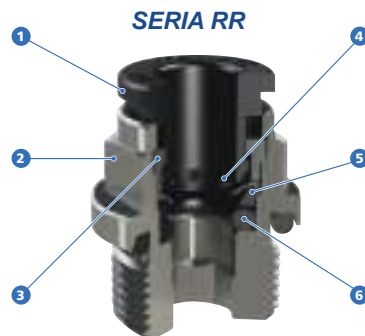

- 1 Unaza lidhese
- 2 Trupi
- 3 Unaza ngushtuese
- 4 Mberthyes
- 5 Unaza mbrojtese
- 6 Guarnicioni



Produktet në përputhje me standartet 2002/95/EC



Produktet në përputhje me standartet 2011/65/BE

### Rakorderi per tub najloni me kapje (M)

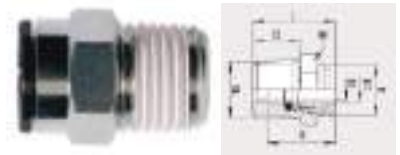

Kodi	L	Masa		Çmimi
RR6033/1	1/8	4x2	10	<b>190</b>
RR6033/5	1/8	6x4	10	<b>190</b>
RR6033/6	1/4	6x4	10	<b>225</b>
RR6033/7	1/8	8x6	10	<b>255</b>
RR6033/8	1/4	8x6	10	<b>255</b>
RR6033/9	3/8	8x6	10	<b>290</b>
RR6033/10	1/4	10x8	10	<b>325</b>
RR6033/11	3/8	10x8	10	<b>320</b>
RR6033/12	1/2	10x8	10	<b>445</b>
RR6033/13	1/4	12x8	10	<b>380</b>
RR6033/14	3/8	12x8	10	<b>390</b>
RR6033/15	1/2	12x8	10	<b>490</b>

### Rakorderi per tub najloni me kapje (F)

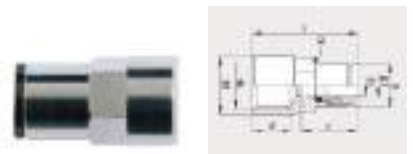

Kodi	L	Masa		Çmimi
RR6035/1	1/8	4x2	10	<b>270</b>
RR6035/6	1/8	6x4	10	<b>225</b>
RR6035/7	1/4	6x4	10	<b>280</b>
RR6035/8	1/8	8x6	10	<b>290</b>
RR6035/9	1/4	8x6	10	<b>290</b>
RR6035/10	1/4	10x8	10	<b>330</b>
RR6035/11	3/8	12x10	10	<b>450</b>
RR6035/12	1/4	12x10	10	<b>390</b>
RR6035/13	3/8	12x10	10	<b>450</b>
RR6035/14	1/2	12x10	10	<b>450</b>

### Rakorderi (L) per tub najloni

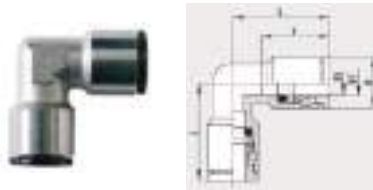

Kodi	Permasa		Çmimi
RR6036/1	4X2	10	<b>350</b>
RR6036/3	6X4	10	<b>350</b>
RR6036/4	8X6	10	<b>390</b>
RR6036/5	10X8	10	<b>490</b>
RR6036/6	12X10	10	<b>590</b>

### Rakorderi (T) per tub najloni



Kodi	Permasa		Çmimi
RR6042/1	4 mm	10	<b>420</b>
RR6042/3	6 mm	10	<b>450</b>
RR6042/4	8 mm	10	<b>550</b>
RR6042/5	10 mm	10	<b>650</b>
RR6042/6	12 mm	10	<b>890</b>

### Rakorderi (Y) per tub najloni

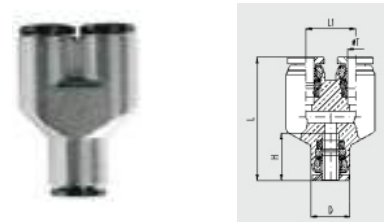

Kodi	Permasa		Çmimi
RR6056/3	6 mm	10	<b>790</b>
RR6056/8	8 mm	10	<b>890</b>
RR6056/10	10 mm	10	<b>990</b>
RR6056/12	12 mm	10	<b>1.250</b>

### Rakorderi (L) per tub najloni me kapje (M)



Kodi	L	Masa		Çmimi
RR6037/1	1/8	4x2	10	<b>290</b>
RR6037/3	1/8	6x4	10	<b>290</b>
RR6037/4	1/4	6x4	10	<b>340</b>
RR6037/5	1/8	8x6	10	<b>340</b>
RR6037/6	1/4	8x6	10	<b>340</b>
RR6037/7	3/8	8x6	10	<b>450</b>
RR6037/8	1/4	10x8	10	<b>460</b>
RR6037/9	1/8	10x8	10	<b>470</b>
RR6037/10	1/4	12x10	10	<b>590</b>
RR6037/11	3/8	12x10	10	<b>590</b>

### Rakorderi (T) per tub najloni (M)



Kodi	L	Masa		Çmimi
RR6043/1	1/8	4 mm	10	<b>450</b>
RR6043/3	1/8	6 mm	10	<b>450</b>
RR6043/4	1/4	6 mm	10	<b>490</b>
RR6043/5	1/8	8 mm	10	<b>550</b>
RR6043/6	1/4	8 mm	10	<b>550</b>
RR6043/8	1/4	10 mm	10	<b>550</b>
RR6043/9	3/8	10 mm	10	<b>690</b>
RR6043/11	3/8	12 mm	10	<b>890</b>

### Rakorderi plastike e drejte per tub najloni



Kodi	Permasa		Çmimi
RT6114/1	4 mm	10	<b>145</b>
RT6114/3	6 mm	10	<b>155</b>
RT6114/5	8 mm	10	<b>160</b>
RT6114/7	10 mm	10	<b>180</b>
RT6114/9	12 mm	10	<b>225</b>

### Rakorderi plastike T per tub najloni



Kodi	Permasa		Çmimi
RT6116/1	4 mm	10	<b>210</b>
RT6116/2	6 mm	10	<b>210</b>
RT6116/3	8 mm	10	<b>225</b>
RT6116/4	10 mm	10	<b>310</b>
RT6116/5	12 mm	10	<b>370</b>

### Rakorderi L per tub najloni me kapje (M) e rrotullueshme



Kodi	L	Masa		Çmimi
RR6038/2	1/8	4 mm	10	<b>350</b>
RR6038/8	1/8	6 mm	10	<b>350</b>
RR6038/9	1/4	6 mm	10	<b>390</b>
RR6038/10	1/8	8 mm	10	<b>390</b>
RR6038/11	1/4	8 mm	10	<b>450</b>
RR6038/14	1/4	10 mm	10	<b>590</b>
RR6038/15	3/8	10 mm	10	<b>590</b>
RR6038/19	1/2	12 mm	10	<b>850</b>

### Rakorderi kryq per tub najloni

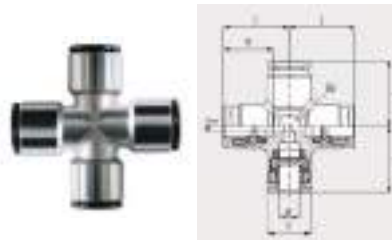

Kodi	Permasa		Çmimi
RR6045/3	6 mm	10	<b>890</b>
RR6045/4	8 mm	10	<b>990</b>
RR6045/5	10 mm	10	<b>990</b>
RR6045/6	12 mm	10	<b>1.290</b>



### Rakorderi plastike (Y) per tub najloni



Kodi	Permasa		Çmimi
RT6117/1	4 mm	10	<b>245</b>
RT6117/2	6 mm	10	<b>245</b>
RT6117/3	8 mm	10	<b>270</b>
RT6117/4	10 mm	10	<b>290</b>
RT6117/5	12 mm	10	<b>350</b>

**Rubinet me sferë (M)(F)**

Kodi	Permasa		Çmimi
1268/1	F-M 1/8	1	<b>990</b>
1268/2	F-M 1/4	1	<b>990</b>
1268/3	F-M 3/8	1	<b>990</b>
1268/4	F-M 1/2	1	<b>990</b>

**Rubinet me sferë (F)(F)**

Kodi	Permasa		Çmimi
1267/1	F-M 1/8	1	<b>990</b>
1267/2	F-M 1/4	1	<b>990</b>
1267/3	F-M 3/8	1	<b>990</b>
1267/4	F-M 1/2	1	<b>990</b>

**Rubinet me sferë (M)(F)**

Kodi	Permasa		Çmimi
1266/2	F-M 1/4	1	<b>1.250</b>
1266/3	F-M 3/8	1	<b>1.290</b>
1266/4	F-M 1/2	1	<b>1.590</b>

**Mini aerograf boje profesional  
1-2 bar me depozite 150 ml**

Kodi	Depozita	Çmimi
MINIPAINT150	150 ml	<b>13.900</b>

**Pistoletë pastrimi me maje te shkurter**

Kodi	Presioni	Sprucimi	Çmimi
60A-1	6 bar	200l/min	<b>790</b>

**Pistoletë plastike pastrimi me maje te shkurter**

Kodi	Çmimi
NYCAS-5	<b>590</b>

**Pistoletë plastike pastrimi me maje te shkurter**

Kodi	Çmimi
NYCAS-1	<b>590</b>

**Pistoletë pastrimi me maje te gjate**

Kodi	Presioni	Sprucimi	Çmimi
60B-1	6 bar	200 l/min	<b>890</b>

**Pistoletë per fryrje gomash**

Kodi	Presioni	Tubi	Çmimi
60D-1	0-12 bar	40 cm	<b>2.490</b>

**Koke rezerve per pistoletat e fryrjes te gomave bronxi**

Kodi	Kapja	Çmimi
60E/O8	8 mm	<b>390</b>

**Koke rezerve per pistoletat e fryrjes te gomave**

Kodi	Kapja	Çmimi
60E/8	8 mm	<b>350</b>

**Filter maske antialergjik**

Kodi	Çmimi
FMC	<b>450</b>



### Tub ajri spiral me kapje me bajonete



Kodi	Tubi	Permasa	Çmimi
SRB10/6	10 M	6X8	<b>1.750</b>
SRB10/8	10 M	8X10	<b>2.250</b>

### Tub ajri spiral me kapje universale

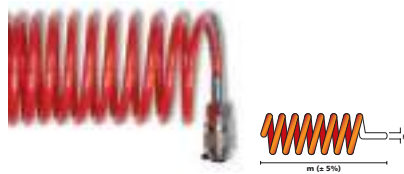

Kodi	Tubi	Permasa	Çmimi
SRU10/6	10 M	6X8	<b>2.590</b>
SRU10/8	10 M	8X10	<b>3.250</b>
SRU20/6	20 M	6X8	<b>3.750</b>
SRU20/8	20 M	8X10	<b>5.500</b>

### Tub ajri spiral pa rakorde



Kodi	Tubi	Permasa	Çmimi
SSA30/6	30 M	6X8	<b>3.990</b>
SSA30/8	30 M	8X10	<b>6.500</b>

### Silenciator zhurme bronxi



Kodi	Permasa	Çmimi
SEP/2	1/4 M	<b>250</b>

### Vaj per lubrifikim makinerish 1L



Kodi	Depozita	Çmimi
SPRINTERADVP	1L	<b>2.490</b>

### Manometer ajri me kapje nga mbrapa 1/4



Kodi	Presioni	Çmimi
M001	0-12 bar	<b>1.250</b>

### Valvul sigurie



Kodi	Permasa	Çmimi
VST1	1/4M /4-16 Bar	<b>450</b>
VST2	3/8M /4-16 Bar	<b>890</b>
VST3	1/2M /4-16 Bar	<b>990</b>

### Presostat trefazor 1 dalje 1/4 - 4 dalje 1/4



Kodi	Presioni	Permasa	Çmimi
PRT1	12 bar	90x58x130	<b>3.500</b>
PRT4	12 bar	90x58x130	<b>3.900</b>

### Presostat monofaze 1 dalje 1/4 - 4 dalje 1/4



Kodi	Presioni	Permasa	Çmimi
PRM1	12 bar	80x50x125	<b>2.900</b>
PRM4	12 bar	80x50x125	<b>2.900</b>

### Valvul moskthimi



Kodi	Permasa	Çmimi
VR00110 NBR	1/2M - 3/8M	<b>990</b>
VR00113 NBR	1/2M - 1/2M	<b>1.450</b>
VR00117 NBR	3/4M - 1/2M	<b>1.450</b>
VR00138 NBR	3/8M - 3/8M	<b>990</b>

### KIT/SANY AIR



Prurja: 100 L / min  
 Presioni: 2 bar  
 Fuqia: 0.35 KV  
 Nivel i zhurmes: 72 dB  
 Peshë: 8 kg  
 Tubi i zgjatueshem spiral: 10 m  
 Sistemi NYCA-BP i pistoletes

**9.900**





**Tashmë 16 modele të kapëseve pneumatike për maja të ndryshme, janë të pajisura me teknologjinë revolucionare Optiwear Technology!**

**Performancë e lartë  
Jetëgjatësi dhe përdorim ideal  
i energjisë**



- Pjesë konsumi të optimizuara
- Jetëgjatësi shërbimi
- Përdorim i lehtë i sistemit të këmbëzës
- Pak zhurmë dhe dridhje
- Moment i shpejtë i kapjes
- E fuqishme
- Konsum i ulët i ajrit
- Jo kthim pas i veçlës gjatë punës



**Kodifikimi i majave Prebena  
Për shembull maja ES32CNKHA**

**ES 32 C NK HA**



- AL**=alumin
- BK**=me shkelqim
- BZ**=bronzi
- LF**=e kuqerremte
- LS**=e shkelqyshme
- MS**=tunxh
- NK**=galvanizuar
- NN**=kallaj
- NS**=nikel i argjente
- RF**=inox (1.4301)
- RFRILI**=inox
- SV**=çelik i forte i galvanizuar
- ST**=çelik i galvanizuar me rezistence terheqje
- VK**=baker
- VS**=çelik i bakerzuar
- VZ**=galvanizuar ne te nxehte



**MADE IN GERMANY**

Kapëset tona janë të prodhuara në fabrikën tonë në Gjermani.

**1GP-A16**

Kapëse Profi pneumatike për dru të fortë. Parket, prodhim mobiljesh. Përdor kapëse të tipit A 4-16 mm

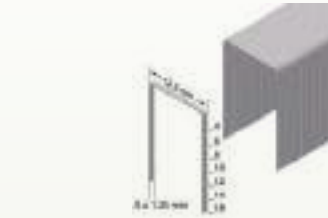

**17.500**

**1XR-A16**

Kapëse për maja A deri 16 mm

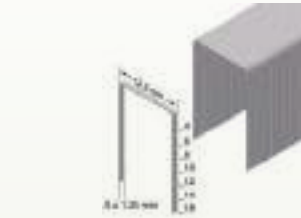

**8.500**

**1GP-AL35**

Kapëse Profi pneumatike për dru të fortë. Parket, prodhim mobiljesh. Përdor maja pa kokë të tipit AL10-35 mm



**32.900**

**2P-J50**

Kapëse Profi pneumatike për ngulje në dru të fortë. Prodhim paletash, kornizash dhe parketesh. Përdor kapëse të tipit J 16-50 mm



**23.900**

**2XR-J50**

Kapëse për gozhde J deri ne 50mm



**11.500**

**2XR-ES40**

Kapëse për maja ES deri ne 40mm



**11.500**

**2P-ES40**

Kapëse Combi pneumatike për prodhim mobiljesh, izolim, mbulim, tapiceri, shtrim parketi. Përdor kapëse të tipit ES 12-40mm



**26.500**

**2P-J/ES40**

Kapëse Combi pneumatike për prodhim mobiljesh, izolim, mbulim, tapiceri, shtrim parketi. Përdor kapëse të tipit J 15-40mm



**25.900**



**2M-GA32**

Kapëse ajri per gozhde pa koka deri ne 32 mm



OPTIWEAR-TECHNOLOGY

PREBENA

**37.500**

**3GP-Z40**

Kapëse pneumatike per maja Z 16-40 mm



OPTIWEAR-TECHNOLOGY

PREBENA

**29.900**

**4C-Z50**

Kapëse per maja Z 25-50 mm



OPTIWEAR-TECHNOLOGY

PREBENA

**42.900**

**7XR-RK90**

Kapëse me maja per gozhde RK deri ne 90 mm



OPTIWEAR-TECHNOLOGY

PREBENA

**29.900**

**HFPF09**

Kapëse dore me goditje per maja PF



OPTIWEAR-TECHNOLOGY



PREBENA

**5.500**

**HTVX08**

Kapëse Dore për maja VX08



OPTIWEAR-TECHNOLOGY



PREBENA

**1.990**

**HP-J/VX16**

Kapëse Dore për maja VX16 dhe gozhdë "J16"



OPTIWEAR-TECHNOLOGY



PREBENA

**3.990**

**HPPF14**

Kapëse Dore për fiksimin e tapicerive dekorimeve dhe paketimeve. Përdor kapëse të tipit PF 6-14 mm



OPTIWEAR-TECHNOLOGY



PREBENA

**3.990**

PREBENA



OPTIWEAR-TECHNOLOGY

Kodi	Cope / Paketim	Çmimi
VX06CNK	6.000	<b>850</b>
VX08CNK	5.000	<b>850</b>

PREBENA



OPTIWEAR-TECHNOLOGY

Kodi	Cope / Paketim	Çmimi
VX10CNK	4.000	<b>690</b>
VX12CNK	3.000	<b>690</b>
VX14CNK	3.000	<b>790</b>

PREBENA



OPTIWEAR-TECHNOLOGY

Kodi	Cope / Paketim	Çmimi
PF06CNK	8.000	<b>1.590</b>
PF09CNK	5.000	<b>1.290</b>

PREBENA



OPTIWEAR-TECHNOLOGY

Kodi	Cope / Paketim	Çmimi
PF12CNK	4.000	<b>990</b>
PF14CNK	3.000	<b>890</b>

PREBENA



OPTIWEAR-TECHNOLOGY

Kodi	Cope / Paketim	Çmimi
A04CNK	10.000	<b>1.350</b>
A06CNK	12.000	<b>1.490</b>
A08CNK	10.000	<b>1.450</b>

PREBENA



OPTIWEAR-TECHNOLOGY

Kodi	Cope / Paketim	Çmimi
A10CNK	8.000	<b>1.250</b>
A12CNK	6.000	<b>1.150</b>
A14CNK	6.000	<b>1.250</b>
A16CNK	4.000	<b>950</b>



Kodi	Cope / Paketim	Çmimi
ES12CNK	10.400	<b>2.900</b>
ES15CNK	7.800	<b>2.290</b>
ES18CNK	7.800	<b>2.690</b>
ES23CNK	5.200	<b>2.590</b>



Kodi	Cope / Paketim	Çmimi
ES26CNK	5.200	<b>2.390</b>
ES30CNK	5.200	<b>2.500</b>
ES32CNK	2.600	<b>1.390</b>
ES35CNK	2.600	<b>1.790</b>
ES40CNK	2.600	<b>1.990</b>



Kodi	Cope / Paketim	Çmimi
AL10CLS	30.000	<b>2.900</b>
AL12CLS	20.000	<b>2.900</b>
AL15CLS	20.000	<b>3.500</b>
AL17CLS	20.000	<b>3.500</b>
AL20CLS	10.000	<b>2.500</b>
AL25CLS	10.000	<b>2.900</b>
AL30CLS	20.000	<b>2.900</b>



Kodi	Cope / Paketim	Çmimi
J13CNK	10.000	<b>3.590</b>
J16CNK	10.000	<b>3.500</b>
J19CNK	10.000	<b>3.990</b>
J25CNK	5.000	<b>2.590</b>
J32CNK	5.000	<b>2.790</b>
J40CNK	5.000	<b>2.690</b>
J50CNK	4.000	<b>2.790</b>



Kodi	Cope / Paketim	Çmimi
Z16CNK	27.000	<b>7.900</b>
Z25CNK	17.500	<b>7.900</b>
Z30CNK	14.300	<b>7.900</b>



Kodi	Cope / Paketim	Çmimi
Z32CNK	14.300	<b>7.900</b>
Z35CNK	12.700	<b>7.900</b>
Z38CNK	11.100	<b>7.900</b>
Z40CNK	11.100	<b>7.900</b>



**ZMERILUESE RRETHORE ME AJER TC-PE**

Kodi	Tamponi	Çmimi
41.333.30	150 mm	<b>5.990</b>

**DOREZE KRIKETI ME AJER TC-PR 68**

Kodi	Max shtrengimit	Çmimi
41.391.80	68 Nm	<b>6.990</b>

**PISTOLETE BOJE ME DEPOZITE LARTE 600 MM**

Kodi	Dimensioni	Çmimi
41.330.30	1.4 / 3-3.5 bar	<b>3.990</b>

**PISTOLETE BOJE ME DEPOZITE LARTE 600 MM**

Kodi	Dimensioni	Çmimi
41.330.00	1.4 / 3-4 bar	<b>1.790</b>

**PISTOLETE FRYRJE ME 4 HUNDEZA**

Kodi	Presioni	Çmimi
41.327.62	2-8 bar	<b>890</b>

**PISTOLETE PASTRIMI AJRI METALIKE**

Kodi	Dimensioni	Çmimi
41.331.00	Me maje	<b>550</b>

**PASTRIMI PASTRIMI ME MAJE TE GJATE**

Kodi	Dimensioni	Çmimi
41.331.02	Me maje	<b>590</b>

**FRYRESE GOMASH DIXHITALE**

Kodi	Presioni	Çmimi
41.331.15	0 - 13 bar	<b>2.900</b>

**FRYRESE GOMASH ME MANOMETER**

Kodi	Presioni	Çmimi
41.370.00	0-8 bar	<b>1.500</b>

**KAPESE PNEUMATIKE PER MAJA DHE GOZHDE**

Kodi	Dimensioni	Çmimi
41.377.90	Per maja 16/25/40 Per gozhde 25/40	<b>6.900</b>

**GOZHDE 25 MM PER TE-CN 18 LI**

Kodi	Permasa	Sasia	Çmimi
41.378.71	25 mm	3000	<b>490</b>
41.378.74	32 mm	3000	<b>1.790</b>

**MAJA 19 MM PER TE-CN 18 LI**

Kodi	Permasa	Sasia	Çmimi
41.378.55	19 mm	3000	<b>690</b>
41.378.75	19 mm	3000	<b>790</b>

### KOMPRESOR AJRI MAKINE 12 V



Kodi	Presioni	Çmimi
20.721.12	8 bar	<b>1.950</b>

### PISTOLETE DADICE-KESH PNEUMATIKE 1/2"



Kodi	Diametri	Çmimi
41.389.60	610 Nm	<b>9.900</b>

### MATRAPIK PNEUMATIK 1.2J + AKSESORE



Kodi	Gjatesia	Çmimi
41.390.45	6.3 Bar	<b>6.500</b>

### KARRUKULL AJRI TC-PH150 AUTOMATIKE 15 M



Kodi	Tub	Çmimi
41.380.05	9 mm	<b>9.500</b>

### KARRUKULL AJRI AUTOMATIKE 1/4"



Kodi	Tub	Çmimi
WAZ3515	1/4" x 14 m	<b>4.900</b>

### KARRUKULL AJRI AUTOMATIKE 1/2"



Kodi	Tub	Çmimi
WVZ1515	1/2" x 15 m	<b>6.900</b>

### ZORRE AJRI SPIRALE ME RAKORDERI UNIVERSALE



Kodi	Gjatesia	Çmimi
41.394.20	8 m	<b>850</b>

### TUB AJRI SPIRAL ME KAPJE TE SHPEJTE



Kodi	Gjatesia	Çmimi
BAH1010	10 M	<b>990</b>

### TUB AJRI SPIRAL ME KAPJE UNIVERSALE



Kodi	Presioni max	Çmimi
81492	15 m / 5x8	<b>990</b>

### TUB AJRI ME KAPJE TE SHPEJTE 15 M / 15 BAR



Kodi	Diametri	Çmimi
41.382.00	6 mm	<b>2.500</b>

### ZORRE AJRI SPIRALE ME RAKORDERI UNIVERSALE



Kodi	Gjatesia	Çmimi
41.382.10	9 mm	<b>2.990</b>

### TUB AJRI "TORNADO" 50 M PRESIONI 60 BAR



Kodi	Dimensioni	Çmimi
BAT6000	8X14 MM	<b>5.900</b>

### TUB AJRI GOME ERGON ME 3 SHTRESA 50M



Kodi	Permasa	Çmimi
92300.24550.07	6x14mm	<b>6.990</b>
92300.27050.07	8x17mm	<b>9.500</b>

### TUB AJRI REFITEXX CRYSTAL 50M

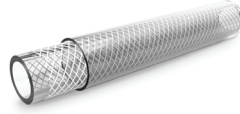

Kodi	Permasa	Çmimi
70000.02250.59	6x12mm	<b>4.500</b>
70000.04550.59	8x14mm	<b>5.900</b>
70000.06950.59	10x16mm	<b>6.900</b>

### TUB AJRI REFITEXX 80 BAR 50M



Kodi	Permasa	Çmimi
70279.07150.59	10x18mm	<b>11.900</b>

### TUB AJRI REFITEXX GAS+GPL



Kodi	Permasa	Çmimi
70603.03950.59	8mm 50m	<b>5.500</b>
70603.03970.59	8mm 70m	<b>7.900</b>

### TUB GAZI DOPIO BINATO 50M



Kodi	Permasa	Çmimi
92871.26850.90060	8x15mm	<b>12.900</b>

### TUB RILSAN POLIETILEN PA12 100M



Kodi	Permasa	Çmimi
PA1204x06	4x6mm	<b>9.900</b>
PA1208x08	6x8mm	<b>18.900</b>
PA1208x10	8x10mm	<b>26.900</b>
PA1210x12	10x12mm	<b>35.900</b>

### GURE FLESIBEL ME AJER



Kodi	Diametri	Çmimi
BAT10005	125 mm	<b>1.590</b>

### PERCINUESE ME AJER DERI 4.8 MM



Kodi	Per percina	Çmimi
70280	2.4-4.8	<b>6.990</b>

### SET PISTOLETE PASTRIMI ME MAJE TE GJATE



Kodi	Perfshire	Çmimi
81634	Tub dhe adaptor	<b>1.500</b>

### PISTOLETE BOJE ME DE-POZITE PLASTIKE 680 ML



Kodi	Presioni max	Çmimi
81618	0.4 MPa	<b>1.590</b>

### MINI OLIATOR PER MAKINERI AJRI 1/4"



Kodi	Dimensioni	Çmimi
81570	0.8 MPa / 5 ml	<b>390</b>

### MINI FILTER PER MAKINERI ME AJER



Kodi	Kapja	Çmimi
81560	1/4"	<b>490</b>



### MASKE RESPIRATORE

**E RE**



Permban 2 filtra

Kodi	P	Çmimi
WRJ2502	8	450

### FILTER MASKE KUNDER PLUHURIT

**E RE**



E pershtatshme per WRJ2502,WRJ1501

Kodi	D	Çmimi
WPV2502	6	90

### ZMERILUESE E DREJTE ME AJER

**E RE**



Kodi	Pi	Çmimi
WAT5514	6	1.990

### PISTOLETE PASTRIMI ME MAJE TE GJATE

**E RE**



Kodi	Permasa	Çmimi
WGA4611	110 mm	250

### SET ME 4 RAKORDERI TE SHPEJTA TIP GJERMAN

**E RE**



Kodi	Kapja	Çmimi
WQP4670	F-M 1/4"	450

### LUBRIFIKANT VAJI PER KOMPRESORE 1/4"

**E RE**



Kodi	Kapaciteti	Çmimi
WEQ1601	10 cc	290

### FILTER AJRI PER KOMPRESORE 1/4"

**E RE**



Kodi	Kapaciteti	Çmimi
WFF2602	15 cc	450

### GRUP FILTER AJRI PER KOMPRESORE 1/4"

**E RE**



Kodi	Kapaciteti	Çmimi
WFF3503	15 cc	850

### GRUP FILTER AJRI + RREGULLATOR + OLIATOR 1/4"

**E RE**



Kodi	Kapaciteti	Çmimi
WFF4504	15 + 25 cc	1.250

### GRUP FILTER AJRI PER KOMPRESORE 1/4"

**E RE**



Kodi	Kapacitetii	Çmimi
WFF5505	80 cc	1.500

### GRUP FILTER AJRI + RREGULLATOR + OLIATOR 1/4"

**E RE**



Kodi	Kapaciteti	Çmimi
WFF6506	80 + 125 cc	2.450

### PISTOLETE BOJE PROFESIONALE 1000 W

**E RE**



Kodi	Sprucimi	Çmimi
WAY1A10	1600ml/min	24.500

### DOREZE KRIKETI ME AJER 1/2"

**3.900**

**ARW121**



Kapja 1/2"  
Forca max. shtrengimit 68 Nm

### PISTOLETE DADICEKESH 1/2"

**6.900**

**AIW12312**



Me 10 koka kriketi  
Kapja 1/2"  
Forca max. shtrengimit 312 Nm

### PISTOLETE DADICEKESH 1/2"

**7.990**

**AIW12562**



Kapja 1/2"  
Forca max. shtrengimit 610 Nm

### PISTOLETE DADICEKESH 3/4"

**14.900**

**AIW341302**



Kapja 3/4"  
Forca max. shtrengimit 1600 Nm

### PISTOLETE DADICEKESH 1"

**14.900**

**AIW11223**



Kapja 1"  
Forca max. shtrengimit 1800 Nm

### PISTOLETE DADICEKESH 1"

**28.900**

**AIW11222**



Kapja 1"  
Forca max. shtrengimit 3100 Nm

### KIT AJRI 5 COPE

**2.990**

**AKT0053**



(Pistolet boje me depozite larte plastike)

### ZMERILUESE RRETHORE ME AJER

**6.900**

**APS1512**



Tamponi 150 mm  
Presioni 6.3 bar

### PISTOLETE BOJE

1.990

ASG4041



Me depozite alumini lartë  
 Depozite 400 ml  
 Koka e sprucimit 1.5 mm

### PISTOLETE BOJE

1.990

ASG4042



Me depozite alumini lartë  
 Depozite 400 ml  
 Koka e sprucimit 1.5 mm

### PISTOLETE BOJE HVLP

2.900

ASG1061



Me depozite plastike lartë  
 Depozite 600 ml  
 Koka e sprucimit 1.4 mm

### PISTOLETE BOJE LVMP

8.900

ASG1065



Me depozite plastike lartë  
 Depozite 600 ml  
 Koka e sprucimit 1.3 mm

### PISTOLETE BOJE ME DEPOZITE ALUMINI POSHTE

3.500

ASG2101



Me depozite alumini poshte HVLP 1000 cc  
 Koka e sprucimit 1.4 mm

### PISTOLET BOJE ME DOPOZITE ALUMINI POSHTE

1.990

ASG3101



Depozite 1000 ml  
 Koka e sprucimit 1.5 mm

### PISTOLETE BOJE ME DOPOZITE ALUMINI POSHTE

1.990

ASG3105



Depozite 1000 ml  
 Koka e sprucimit 1.8 mm

### PISTOLETE PASTRIMI 1000 CC

390

ABG031



Me maje te shkurter  
 Koka e sprucimit 16 mm



### PISTOLETE VAJISJE ME AJER

1.150

AWG1001



Depozite  
Poshte (Paketimi 2 Cope)

0.75 L

### PISTOLETE PER FRYRJE GOMASH

1.350

ATG0601



Me manometer 12bar

### TUB SPIRAL 5X8 ME BASHKUES TE SHPEJTE UNIVERAL

790

AH1051



Permase

5 m

### TUB SPIRAL 5X8 ME BASHKUES TE SHPEJTE UNIVERAL

1.250

AH1101



Permase

10 m

### TUB SPIRAL 5X8 ME BASHKUES TE SHPEJTE UNIVERAL

1.590

AH1151



Permase

15 m

### POMPE GRASO ME AJER 30 L

21.900

AGL02301



Depozite  
Presioni

30 Lt  
6-8 Bar

### POMPE GRASO ME AJER 45 L

22.500

AGL02451



Depozite  
Presioni

45 Lt  
6-8 Bar

### KAPESE DORE PER MAJA 2 NE 1

1.690

HSG1406



Perfshin 1000 maja

500 cope maja 6 - 14 mm  
500 cope maja 10 - 15 mm

### KAPESE DORE PER MAJA

690

HSG14012



Maja

4-8 mm

### KAPESE DORE PER MAJA

790

HSG14018



Maja

4-14 mm

(STS0108/STS0110/STS0112)

### KAPESE DORE PER MAJA 3 NE 1

990

HSG1405



Perfshin 600 maja

200 maja 4 - 14 mm  
200 maja 10 - 12 mm  
200 maja 40 - 14 mm

### KAPESE DORE PER MAJA

1.690

HSG1404



Maja

4-14 mm

(perfshire 1000 maja)

### KAPESE PNEUMATIKE PER GOZHDE BETONI

6.900

ACN18641



Per gozhde betoni 18-64mm

### PISTOLETE AJRI PER MAJA U

3.900

APS06161



Per maja U 6-16 mm

### PISTOLETE AJRI PER MAJA U

3.500

APS04161



Per maja 4-16 0.4-0.7Mpa (60-100psi)  
+ 1000 maja te perfshira



### PISTOLETE GOZHDESH

2.990

ABN10301



Per maja 10-30 mm

### PISTOLETE GOZHDESH



4.590

ABN15501

Per maja 15-50 mm  
Perfshin 1000 maja

### PISTOLETE 2 NE 1 Ga18



4.500

ACN50401

Per maja U dhe gozhde 16-40 mm / 15-50 mm  
Perfshin 200 maja + 1000 gozhde

### GOZHDE PA KOKE PER KAPESE ME BATERI CBNLI3603, CBNLI3606

**ERE**

690



ANA06825

Permasa: 0.64 x 25 mm

### MAJA PER KAPESE HSG1404 (paketimi 1000 cope)



Kodi	Permasa	Çmimi
STS0208	8 mm	<b>120</b>
STS0210	10 mm	<b>140</b>
STS0212	12 mm	<b>150</b>

### MAJA PER APS04161 (PAKETIMI 10000 COPE)



Kodi	Permasa	Çmimi
AST18082	8 mm	<b>360</b>
AST18102	10 mm	<b>490</b>
AST18122	12 mm	<b>550</b>

### MAJA PER ACN50401 (PAKETIMI 2500 COPE)



Kodi	Permasa	Çmimi
AST18251	25 mm	<b>690</b>
AST18351	35 mm	<b>890</b>
AST18401	40 mm	<b>990</b>

### MAJA 20MM PER KAPESE ACN50401, ABN15501, ABN10301 DHE ABN10301-3 (5000 COPE)



Kodi	Permasa	Çmimi
ANA18201	20 mm	<b>450</b>
ANA18251	25 mm	<b>650</b>
ANA18301	30 mm	<b>690</b>
ANA18351	35 mm	<b>850</b>
ANA18401	40 mm	<b>890</b>
ANA18501	50 mm	<b>990</b>

### GOZHDE PER KAPESE ACN18641 (Paketimi 1000 cope)



Kodi	Permasa	Çmimi
ANA01251	25 mm	<b>550</b>
ANA01321	32 mm	<b>690</b>
ANA01381	38 mm	<b>890</b>
ANA01501	50 mm	<b>990</b>
ANA01641	64 mm	<b>1.250</b>





**PAJISJE SERVISI  
DHE AKSESORË**

## KRIK HIDRAULIK BIG RED JACKS

**TH90204X**  
Krik hidraulik  
2 Ton  
**1.950**



**TCH90404D**  
Krik hidraulik  
4 Ton  
**2.500**



**TH90804X**  
Krik hidraulik  
8 Ton  
**3.590**



Kodi	Kapaciteti	Min. Lartese (mm)	Lartesia e ngritjes (mm)	Lartesia e rregullueshme (mm)	N.W / G.W. / (Kg)
TH90204X	2 Ton	180	112	48	2.35 / 2.46
TCH90404D	4 Ton	190	118	60	2.95 / 3.1
TH90804X	8 Ton	225	145	80	4.95 / 5.1

**TH91004X**  
Krik hidraulik  
10 Ton  
**3.900**



**TH92004X**  
Krik hidraulik  
20 Ton  
**5.900**



**TH91001**  
Krik hidraulik  
Profi 10 Ton

**PROFI**

I kromuar Profesional

**5.900**



Kodi	Kapaciteti	Min. Lartese (mm)	Lartesia e ngritjes (mm)	Lartesia e rregullueshme (mm)	N.W / G.W. / (Kg)
TH91004X	10 Ton	225	145	80	4.95 / 5.1
TH92004X	20 Ton	280	170	-	2.95 / 3.1
TH910001	10 Ton	240	150	60	9.70 / 10.1

**TH80202X**  
Krik hidraulik  
dopio piston  
2 Ton  
**3.900**



**TH80602X**  
Krik hidraulik  
dopio piston  
6 Ton  
**4.900**



**TH81002X**  
Krik hidraulik  
dopio piston  
10 Ton  
**6.900**



Kodi	Kapaciteti	Min. Lartese (mm)	Lartesia e ngritjes (mm)	Lartesia e rregullueshme (mm)	N.W / G.W. / (Kg)
TH80202X	2 Ton	170	210	60	2.6 / 2.7
TH80602X	6 Ton	170	200	60	5.35 / 5.48
TH81002X	10 Ton	180	21	60	26

## KRIK KROKODIL BIG RED JACKS

**TA820011**  
Krik krokodil 2 Ton



**4.500**

**T825051**  
Krik krokodil i gjate me profil te ulet 2.5 ton



**7.500**

**T815016L**  
Krik krokodil alumini 1.5 T



**14.500**

**T825011CL**  
Krik krokodil alumini 2.5 T



**22.500**

Kodi	Kapaciteti	Min. Lartesise (mm)	Max. Lartesise (mm)	Permase produktit (mm)
TA820011	2 Ton	140	285	534 x 216 x 145
T825051	2.5 Ton	96	381	147 x 259 x 627
T815016L	1.5 Ton	100	460	650 x 292 x 170
T825011CL	2.5 Ton	100	460	650 x 292 x 170

## MBAJTESE AKSI BIG RED JACKS



**T42004**  
Mbjatese aksi te palosshme 2 Ton

**2.250**



**T43004**  
Mbjatese aksi te palosshme 3 Ton

**2.550**



**T42002X**  
Mbjatese aksi 2 Ton (2 cope)

**2.900**



**T46002**  
Mbjatese aksi 6 Ton (2 cope)

**6.900**

Kodi	Kapaciteti	Min. Lartesise (mm)	Max. Lartesise (mm)	Permase produktit (mm)
T42004	2 Ton	276	363	190 x 190 x 363
T43004	3 Ton	300	410	190 x 190 x 410
T42002X	2 Ton	250	380	200 x 160 x 315
T46002	6 Ton	390	610	290 x 260 x 460



**T70401S**  
Krik Hidraulik Karamboli 4 Ton

**15.900**



**T71002L**  
Krik Hidraulik Karamboli 10 Ton

**24.900**



**COMBOSET**  
**Combo set**  
SET: TA820014 - Krik krokodil 2 ton  
TRH6454B - Shtrat mekaniku i palosshem  
T42002X - 2 Mbjatese aksi 2 ton

**9.900**



## PRESA PNEUMATIKE / HIDRAULIKE



**TY10003**  
Prese Hidraulike  
tavoline 10 Ton

**32.900**



**TY12002A**  
Prese Hidraulike  
12 Ton

**43.900**



**TY20001**  
Prese Hidraulike  
20 Ton

**57.900**

Kodi	Kapaciteti	Gjatesia e hapjes se pistonit	Permasat (mm)
TY10003	10 Ton	175 mm	680 x 450 x 1070 mm
TY12002A	12 Ton	175 mm	1375 x 165 x 195 mm
TY20001	20 Ton	185 mm	1550 x 185 x 135 mm



**TY30001**  
Prese Hidraulike 30 Ton  
**95.000**



**TY50001**  
Prese hidraulike 50 Ton  
**129.900**

Kodi	Kapaciteti	Gjatesia e hapjes se pistonit	Permasat (mm)
TY30001	30 Ton	840 mm	1620 x 380 x 310 mm
TY50001	50 Ton	890 mm	920 x 380 x 1792 mm



**TEL06011**  
Krik kambio  
0.6 Ton 1135-1975mm

**32.900**

Kodi	Kapaciteti
TEL06011	0.6 Ton

**VINC MOTORI / MBAJTESE MOTORI**

**T31002CX**  
Vinc motori  
1 Ton

**28.900**



**T32002CX**  
Vinc motori  
2 Ton

**37.500**



**T26801**  
Mbjatëse motori  
680 kg

**15.900**



Kodi	Kapaciteti
TT31002CX	1 Ton

Kodi	Kapaciteti
T32002CX	2 Ton

Kodi	Kapaciteti
T26801	680 kg



**TRF2750**  
Bilancues per  
mbajtëse motorri

**2.990**



**TRG2094**  
Depozite pritëse vaji 100 L

**14.500**



**TRG2090**  
Pritëse dhe thithëse  
vaji me depozite 90 L

**31.900**



**TRG25L.2.0**  
Bombul shkume 25 Lt

**17.500**



**TRG50L.2.0**  
Bombul shkume 50 Lt

**19.500**



**TRH25M**  
Pompe grasatimi  
mekanike 25 L

**11.500**

**KITE / TESTUES**



**TRHS-E1243 9.500**  
Kit ekstratoresh per heqjen e kushinetave



**TRHS-A0031 3.900**  
Testues komprimimi motorra Benzine



**TRHS-A1020A 4.900**  
Testues komprimimi motorra Naftë



**TRHS-A1998A 4.900**  
Kit pompe Vakumi



**TRHS-E3318B 7.500**  
Ekstrator universal per lirimin e pistoncinave te frenave



**TRHS-E3431 4.900**  
Kit ekstratoresh universal per kokat e zbares



**TRHS-3416 22.900**  
Ekstarator universal per lirimin e kushinetave



**TRHS-A3310 23.500**  
Set per testimin e rrjedhjeve te ujit me 14 tapa najloni



**TRX31003 5.900**  
Set per lirimin e dadicekeve te kamioneve



**TRWD0200 750**  
Kabell starti 200 AMP



**TRWD0400 990**  
Kabell starti 400 AMP



**TRWD0800 1.490**  
Kabell starti 800 AMP



**EKSTRATOR / SHTRAT MEKANIKU**
**TRK1500-6C**

Ekstrator sustash statik bashke me mbrojtje

**27.900**

**TRK1500-6Q**

Ekstrator pneumatik per sustat 1 Ton

**29.900**

**TRK1500-2**

Ekstrator sustash statik

**21.900**

**TRA1812**

Krik pneumatik 2 Ton / Lartesia 430 mm

**23.900**

**TRA1813**

Krik pneumatik 2 Ton / Lartesia 560 mm

**29.900**

**TRHS-E1107**

Ekstrator sustash

**3.900**

**TRHL6201**

Stol mekaniku me rrota l rregullueshem 39-52cm

**3.900**

**TRH6802-2**

Shtrat mekaniku plastik

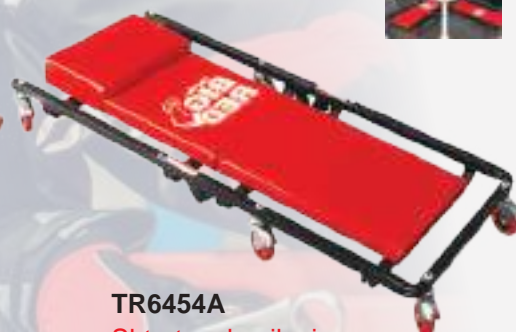
**4.690**

**TR6454A**

Shtrat mekaniku i palosshem

**4.500**

**TRT1161C**

Cikrik 2 Ton me dopio kriket

**3.900**
**Dopio kriket**

**TRK8021**

Cikrik 2 Ton me dopio kriket me kavo 2.8 m

**3.500**

**TRH92000**

Vinc elektrik karotreci Kapaciteti 907kg

**14.500**

### KRIK HIDRAULIK



Kodi	Kapacitet	Çmimi
HBJ202	2 Ton	1.900
HBJ402	4 Ton	2.190
HBJ602	6 Ton	2.990
HBJ1002	10 Ton	3.900

### KRIK HIDRAULIK



Kodi	Kapaciteti	Çmimi
HBJ1202	12 Ton	4.500
HBJ2002	20 Ton	5.900
HBJ3002	30 Ton	11.900
HBJ5002	50 Ton	12.900

### KRIK KROKODIL 2 TON

5.500

HFJ201



Lartesia min  
Lartesia max

140 mm  
340 mm

### KRIK KROKODIL 2.5 TON

**IRI**

**2.5Ton**

9.500

HFJ251



Lartesia min  
Lartesia max

89 mm  
360 mm

### KRIK KROKODIL 3 TON

8.900

HFJ302



Lartesia min  
Lartesia max

135 mm  
410 mm

### KRIK KROKODIL ME NGRITJE TE SHPEJTE 3 TON

**IRI**

Quick Lift

**3Ton**

19.500

HFJ303



Lartesia min  
Lartesia max

135 mm  
410 mm

### KRIK KROKODIL ME PROFIL TE ULET 3 TON

14.500

HFJ304

Quick Lift  
Dual Pump



**3Ton**



80mm Low Profile

Kapaciteti

3 T

### KRIK KROKODIL I GJATE 10 TON

59.900

HLFJ1001



Lartesia min  
Lartesia max

145 mm  
560 mm

### BAZAMENT VINČI MOTORI 2 T

8.500

HEC21-1



Kapaciteti  
Ngritja

2 T  
25 - 2000 mm

### KRAH VINČI MOTORI 2 T

29.900

HEC21-2



Kapaciteti  
Ngritja

2 T  
25 - 2000 mm

### MBAJTESE MOTORI

11.500

HEC051



Kapaciteti  
Permasa

450 KG  
925 x 780 x 850 mm

### KRIK KAMBIO 0.5 T

21.900

HTJ0501



Kapaciteti

0.5 T

### SET ME 2 MBAJTESE AKSI

3.150

HJS0201



Lartesia min/max  
Kapaciteti

250-380 mm  
2T

### SET ME 2 MBAJTESE AKSI

4.190

HJS0301



Lartesia min/max  
Kapaciteti

285-425 mm  
3T

### TRANSPALETE ME PISTON CELIKU 2500 KG

37.500

HHPT01251



Pesha

2500 KG

### TRANSPALETE ME PISTON GIZE 3000 KG

45.500

HHPT01301



Pesha

3000 KG

- 1
- 2
- 3
- 4
- 5
- 6
- 7
- 8
- 9
- 10





### Celes dore klasik

Celesi klasik i dores nuk duhet te mungoje ne asnje set veglash dhe gjate 100 viteve te fundit te prodhuar nga MATADOR nuk e ka ndryshuar formen e tij klasike.

**Per prodhimin e celesave, MATADOR perdor vetem Chrom-Vanadium-Celik te kualitetit te larte**



MATADOR si nje nga prodhuesit e pare te veglave, ka futur ne programin e tij qe ne vitet 1990 tek celesat e dores, tekniken e profilin te dallgezuar, (SMART DRIVE) e cila ndihmon qe forca te kaloje direkt ne fileto dhe ruan kendet e dados ose vides pa e demtuar ate.



### Celes dore kriket

MATADOR ka shpikur dhe patentuar me sukses qe ne vitet 1920 celesat e pare kriket.

Qe nga kjo kohe MATADOR eshte nje nga kompanite prodhuese nderkombetare qe udheheqin tregun e prodhimit te veglave me inovacione.



### Teknike precizioni per punime me saktesi

Precizioni eshte pjese e punes, kontrolli me saktesi eshte i domosdoshem. Pothuajse 100% e lidhjeve dhe bashkimeve me fileto ne prodhimet industriale ne ditet e sotme behen me shtrengim te kontrolluar. Shtrengimi i kontrolluar do te thote nje shtrengim ose filetim me nje force ushtrimi te paracaktuar. Per cdo bashkim elementesh me fileto, MATADOR ka prodhuar per cdo proces dhe rast te vecante, veglen e duhur. MATADOR e ka plotesuar gamen e prodhimit te celesave te precizionit duke filluar me celesat e thjeshte manometer, vazhdon me sektorin gjysemprofesional dhe deri te kontrolli elektronik ne shtrengim.



### Teknike ajri me fuqi me te madhe

Vegla ajri ka shume, fatkeqesisht shumica e tyre prodhohen me kualitet te dyshimte. Veglat e ajrit te prodhuara nga MATADOR bindin jo vetem me te dhenat e tyre teknike, por edhe me jetegjatesine e kualitetit industrial. Keto vegla, pavaresisht se jane ne vecanti te qeta dhe te lehta ne perdorim, jane vecanerisht te forta dhe testohen ne kushte ekstreme para se te dalin per perdorim.

DIN  
EN ISO  
6788



# MATADOR është prodhuesi kryesor i mjeteve speciale per industrine e automobilave



## Pince Kapje me cilesi

Nje pince e mire i perket cdo kompleti me vegla.

MATADOR ka nje program shume te zgjeruar per pincat e dores, si pinca prerese, montimi, shtrengimi, hidraulike, gjithashtu pinca te kombinuara per te kryer disa procese.

Pincat MATADOR prodhohen me celik special industrial te avancuar, per nje precision te larte perdorimi qe mund te presin edhe fijen e flokut, si edhe dorezat mbajtese qe sigurisht jane te perbera nga dy komponente.



## Kacavida, maja, celesa ekzagonale

Per cdo gje ne lidhje me vidat, MATADOR prodhon kacavidat, majat dhe celesat ekzagonale teduhur. Gjate perdorimit te veglaveme doreze dy-komponenteshe, mundesohet nje mbajtje perfekte e veglave, qe lejon transmetimin enje force me te madhe ne perdorim pershtatje ideale ne doren e perdoruesit.

Sete te ndryshme majash (si per shembull Smarty Box me doreza ne forme T qe jane te pajisura medhembe mikroskopike dhe maja tecmontueshme) zgjidhin edhe problemin me te vogel ne lidhje me cdo lloj vide dhe jane ndihmesime i mire i cdo profesionisti.



## Vegla dore te pergjithshme

Ne kategorine e veglave te pergjithshme te dores, MATADOR kategorizon te gjitha llojet e veglave qe nuk jane te renditura ne kategorite e tjera, por qe jane te rendesishme ne perdorimin e tyre.

Programi yne permban veglat me goditje, dritat LED, vegla filetimi, si edhe cdo vegël tjetër plotesuese qe mund te nevojitet per perdorime industriale. Tegjitha keto prodhohen me kualitetin e larte MATADOR dhe jane te provuara nder vite nga klientet.



## Vegla per profesione te vecanta

Veglat ne fushen e Serviseve permakinat si edhe ne fushen e elektroteknikes, elektronikes dhe informatikes, zene nje rendesi te vecante te gama e produkteve MATADOR.

MATADOR eshte prodhues dhe furnizues i pare per shume kompani prodhuese automobileshe, si rrjedhoje edhe furnizues me vegla speciale komplekse per serviset e automobivele. Programi qe permban katalogu yne ne kete fushe, zevendeson veglat klasike me ato te specializuara per cdo proces, te cilat nuk duhet te mungojne ne cdo raft servisi.



## Cilësia e testuar sipas ISO 9001:2015



- 1
- 2
- 3
- 4
- 5
- 6
- 7
- 8
- 9
- 10

## ÇELESA FISO STEL DIN 3113A



**0185 6**

Kodi	Permasa	Çmimi
01850060	6	<b>490</b>
01850070	7	<b>490</b>
01850080	8	<b>490</b>
01850090	9	<b>490</b>
01850100	10	<b>490</b>
01850110	11	<b>490</b>
01850120	12	<b>490</b>
01850130	13	<b>550</b>
01850140	14	<b>550</b>
01850150	15	<b>650</b>
01850160	16	<b>690</b>
01850170	17	<b>750</b>
01850180	18	<b>790</b>
01850190	19	<b>850</b>
01850200	20	<b>950</b>
01850210	21	<b>990</b>
01850220	22	<b>1.090</b>
01850240	24	<b>1.290</b>
01850270	27	<b>1.450</b>
01850280	28	<b>1.690</b>
01850300	30	<b>1.890</b>
01850320	32	<b>2.390</b>



## ÇELESA FISO STEL ME KEND



**0190**

Kodi	Permasa	Çmimi
01900260	26	<b>1.900</b>
01900280	28	<b>2.190</b>
01900340	34	<b>3.990</b>
01900360	36	<b>5.990</b>
01900380	38	<b>6.990</b>
01900410	41	<b>7.490</b>
01900460	46	<b>10.500</b>
01900550	55	<b>14.500</b>
01900750	75	<b>34.900</b>
01900800	80	<b>42.900</b>

## ÇELESA POLIGON DIN 383



**0200**

Kodi	Permasa	Çmimi
02001011	10 x 11	<b>1.290</b>
02001013	10 x 13	<b>1.350</b>
02001213	12 x 13	<b>1.450</b>
02001317	13 x 17	<b>1.550</b>
02001415	14 x 15	<b>1.590</b>
02001617	16 x 17	<b>1.650</b>
02001719	17 x 19	<b>1.790</b>
02001819	18 x 19	<b>1.890</b>
02001922	19 x 22	<b>1.990</b>
02002022	20 x 22	<b>2.150</b>
02002123	21 x 23	<b>2.350</b>
02002427	24 x 27	<b>2.590</b>
02002528	25 x 28	<b>2.790</b>
02003032	30 x 32	<b>3.290</b>
02003641	36 x 41	<b>5.990</b>



## ÇELESA TE ÇARE DIN 3118

**0251**

Kodi	Permasa	Çmimi
02510810	8 x 10	<b>1.490</b>
02511011	10 x 11	<b>1.690</b>
02511012	10 x 12	<b>1.790</b>
02511113	11 x 13	<b>1.790</b>
02511314	13 x 14	<b>1.890</b>
02511417	14 x 17	<b>1.990</b>
02511719	17 x 19	<b>2.190</b>
02511922	19 x 22	<b>2.590</b>
02512224	22 x 24	<b>2.890</b>

## ÇELES KRYQ 1/2" PER VETURA

**0350**

Kodi	Permasa	Çmimi
03501001	17 x 19 x 21	<b>1.890</b>

## XHIRO MAKINE CHROM VANADIUM

**0340**

Kodi	Permasa	Çmimi
03402427	24 x 27	<b>4.500</b>
03402732	27 x 32	<b>5.490</b>
03402833	28 x 33	<b>5.590</b>
03403032	30 x 32	<b>5.690</b>

## KRAH XHIRO MAKINE 600 MM

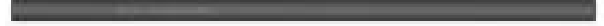
**0342**

Kodi	Permasa	Çmimi
03420600	18x600 mm	<b>1.490</b>

## ÇELES FILTER VAJI ME RRIP

**0425**

Kodi	Permasa	Çmimi
04250001	max. 230	<b>3.790</b>

## ÇELES FILTER VAJI ME RRIP

**0426**

Kodi	Permasa	Çmimi
04260001	max. 240	<b>5.790</b>

## ÇELES KUPE PER FILTER VAJI 3/8"

**0429**

Kodi	Permasa	Çmimi
04290001	82-50 mm	<b>1.790</b>

1

2

3

4

5

6

7

8

9

10

### ÇELES UNIVERSAL PER FILTRIN E VAJIT 3/8"



3/8"

**0428**

Kodi	Permasa	Çmimi
04280003	80-130	<b>3.990</b>

### ÇELES UNIVERSAL PER FILTRIN E VAJIT 1/2"



1/2"

**0428**

Kodi	Permasa	Çmimi
04280145	80-150	<b>22.900</b>

### LEVE GOMASH KAMIONI



**0753**

Kodi	Permasa	Çmimi
07530003	500	<b>2.400</b>
07530004	600	<b>2.990</b>

### LEVE GOMASH KAMIONI



**0754**

Kodi	Permasa	Çmimi
07540002	400	<b>2.890</b>
07540003	500	<b>2.990</b>
07540004	600	<b>3.750</b>

### ÇELES FASHO ME SHTRENGIM



**0567**

Kodi	Ø d mm	Çmimi
05670002	60 - 125 x 80	<b>5.590</b>
05670003	90 - 175 x 80	<b>5.990</b>
05670004	90 - 175 x 105	<b>6.990</b>

### NXJERRES MAGNETIK FLEKSIBEL



**0784**

Kodi	Permasa	Çmimi
07840004	200 (A)	<b>1.100</b>
07840001	1000 (B)	<b>2.250</b>
07840002	1800 (C)	<b>2.990</b>
07840003	3000 (D)	<b>4.990</b>

### KOMPLET ME 4 LEVA

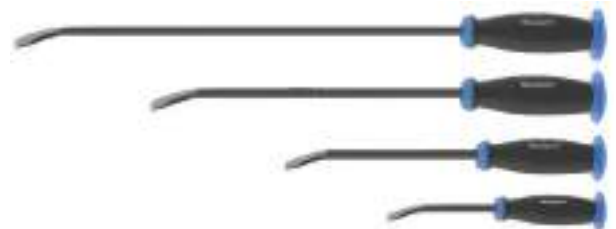

Kodi	Nm	Çmimi
07590010	200-600	<b>6.990</b>

### EKSTRATOR ME DY KRAHE



**0724**

Kodi	Permasa	Çmimi
07240001	20 - 150 x 85	<b>7.900</b>
07240002	40 - 220 x 130	<b>13.500</b>

### EKSTRATOR ME DY KRAHE MINI



**0728**

Kodi	Permasa	Çmimi
07280001	10 - 50 x 40	<b>5.900</b>
07280002	10 - 70 x 65	<b>7.500</b>

### EKSTRATOR ME TRE KRAHE



**0725**

Kodi	Permasa	Çmimi
07250001	20 - 150 x 85	<b>13.900</b>
07250002	40 - 220 x 130	<b>17.900</b>
07250010	50 - 300 x 250	<b>29.500</b>

### EKSTRATOR PER KOKA ZBARE



**0729**

Kodi	Permasa	Çmimi
07290001	18 x 40	<b>6.500</b>
07290002	25 x 50	<b>7.900</b>
07290003	29 x 60	<b>8.500</b>
07290004	40 x 80	<b>11.900</b>

### EKSTRATOR ME SHINE ME DY KRAHE



**0726**

Kodi	Permasa	Çmimi
07260001	20 - 90 x 100	<b>9.500</b>
07260002	25 - 130 x 100	<b>10.500</b>
07260003	50 - 160 x 150	<b>16.900</b>

### EKSTRATOR PER KOKA ZBARE



**0731**

Kodi	Permasa	Çmimi
07310001	18-22 x 50	<b>7.500</b>



### DOREZE KRIKETI 1/4" ME BUTON



**2061**

Kodi	Permasa	Çmimi
20610001	140	4.500

### DOREZE KRIKETI 3/8" ME BUTON



**3061**

Kodi	Permasa	Çmimi
30610001	195	5.500

### DOREZE KRIKETI 1"



**6060**

Kodi	Permasa	Çmimi
60600001	1" x 500 mm	14.900

### ÇELES DINAMOMETRIK 1/2"



**6172**

Kodi	Nm	Çmimi
61720020	1/2" 49 - 210	9.900

### DOREZE KRIKETI 1/2" ME 90 DHEMBE

**25%**

**reduced angle (only 4)**

compared to standart fine-toothed ratchets thanks to an innovative 90-teen technique. still ready for working even when it gets really tight

**50%**

more torque than requested in the DIN standart (e.g. 12.5 mm (1/2") > 750 N.m). Still loosens screws when other have long given up.



Ergonomic and comfortable thumb rest.

**max.**

Ergonomics thanks to multi component handle, better than standart 1-or 2-component handles. Optimally adapted, spherical shape

Push-button lock for a safe conecion between ratchet and socket

Extremely robust square shank made of Chrome Vanadium steel for hight resilience in every situation

**4061**

Kodi	Permasa	Çmimi
40610090	275	6.500

### DOREZE KRIKETI 3/4" ME BUTON & 2 ANE



**5060**

Kodi	Permasa	Çmimi
50600001	3/4"	11.500

### ÇELES DINAMOMETRIK 3/8"



**6172**

Kodi	Nm	Çmimi
61720010	3/8" 20 - 110	8.500

### ZGJATUES KRIKETI 1/4"

**2065**

Kodi	Permasa	Çmimi
20650001	50	<b>690</b>
20650002	100	<b>750</b>

### ZGJATUES KRIKETI 3/8"

**3065**

Kodi	Permasa	Çmimi
30650001	125	<b>1.190</b>
30650002	250	<b>1.790</b>

### ZGJATUES KRIKETI 1/2"

**4065**

Kodi	Permasa	Çmimi
40650001	75	<b>950</b>
40650002	125	<b>1.150</b>
40650003	250	<b>1.350</b>
40660001	250	<b>1.650</b>
40660002	405	<b>1.690</b>

### ZGJATUES KRIKETI 3/4"

**5065**

Kodi	Permasa	Çmimi
50650001	200	<b>3.290</b>
50660002	400	<b>4.500</b>
50650002	420	<b>4.500</b>

### ZGJATUES KRIKETI 1"

**6065**
**6066**

Kodi	Permasa	Çmimi
60650001	205	<b>6.500</b>
60650002	405	<b>7.500</b>
60660002	405	<b>7.990</b>

### ZGJATUES T ME KOKE TE LEVIZSHME

**1/4** **3/8** **1/2**

**2074** **3** **4**

Kodi	Permasa	Çmimi
20740001	1/4"	<b>2.750</b>
30740001	3/8"	<b>2.990</b>
40740001	1/2"	<b>2.950</b>

### LEVE KRIKETI T CHROM VANADIUM + KRAHE KRIKETI (1"X 300 MM)

**2064** **3** **4** **5** **6**

Kodi	Permasa	Çmimi
20640001	1/4"x 115 mm	<b>950</b>
30640001	3/8" x200 mm	<b>1.700</b>
40640001	1/2" x300 mm	<b>1.900</b>
50640001	3/4"x 560 mm	<b>4.500</b>
60640001	1"x 300 mm	<b>8.500</b>

### T - PIPO ME 6 KENDE 230 MM

**0671**

Kodi	Permasa	Çmimi
06710060	6	<b>990</b>
06710070	7	<b>1.090</b>
06710080	8	<b>1.090</b>
06710090	9	<b>1.090</b>
06710100	10	<b>1.090</b>
06710110	11	<b>1.250</b>
06710120	12	<b>1.350</b>
06710130	13	<b>1.450</b>
06710140	14	<b>1.500</b>

### SPRAY PER SISTEMIN E FRENIMIT DHE FREKSIONIT



**8146**

Kodi	Permasa	Çmimi
81460002	500 ml	<b>990</b>

### MATES ANTIFRIZE



Kodi	Çmimi
08060002	<b>3.900</b>

### ADAPTOR KRIKETI 3/8" M -1/4" F



**3082**

Kodi	Permasa	Çmimi
30820001	3/8" M -1/4" F	<b>1.150</b>

### ADAPTOR KRIKETI 3/8" M -1/2" F



**3083**

Kodi	Permasa	Çmimi
30830001	3/8" F -1/2" M	<b>1.150</b>

### KOMPLET KRIKETI 1/2" 23 COPE



**4114**

Kodi	Permasa	Çmimi
41149231	10 - 32 mm	<b>14.500</b>

### ADAPTOR KRIKETI 3/4" M -1/2" F



**4083**

Kodi	Permasa	Çmimi
40830001	3/4" M -1/2" F	<b>790</b>

### ADAPTOR KRIKETI 3/8" M -1/4" F



**2083**

Kodi	Permasa	Çmimi
20830001	3/8" M -1/4" F	<b>990</b>

### ADAPTOR KRIKETI 1/2" M - 3/4" F



**5082**

Kodi	Permasa	Çmimi
50820001	1/2" M -3/4" F	<b>1.450</b>
50830001	1" M -3/4" F	<b>4.500</b>



**ADAPTOR KRIKETI 3/8" M -1/2" F**

**4082**

Kodi	Permasa	Çmimi
40820001	3/8" M -1/2" F	<b>790</b>

**KOKE KRIKETI 1/2" ME 6 FAQE**

**4075**

Kodi	Permasa	Çmimi
40750090	9	<b>690</b>
40750100	10	<b>690</b>
40750110	11	<b>690</b>
40750120	12	<b>690</b>
40750130	13	<b>690</b>
40750140	14	<b>690</b>
40750150	15	<b>690</b>
40750160	16	<b>690</b>
40750170	17	<b>750</b>
40750180	18	<b>750</b>
40750190	19	<b>750</b>
40750200	20	<b>750</b>
40750210	21	<b>750</b>
40750220	22	<b>890</b>
40750240	24	<b>990</b>
40750360	36	<b>1.990</b>

**KOKE KRIKETI E SHKALLEZUAR**

**0342**

Kodi	Per koka	Çmimi
03420250	5, 6, 8, 10, 12 mm	<b>1.290</b>

**ADAPTOR MATADOR 3/4" M -1" F**

**6082**

Kodi	Permasa	Çmimi
60820001	3/4" M -1" F	<b>4.500</b>

**KOKE KRIKETI 1/2" ME 12 FAQE**

**4075**

Kodi	Permasa	Çmimi
40751100	10	<b>490</b>
40751110	11	<b>490</b>
40751120	12	<b>490</b>
40751130	13	<b>550</b>
40751140	14	<b>550</b>
40751150	15	<b>550</b>
40751160	16	<b>550</b>
40751170	17	<b>550</b>
40751180	18	<b>550</b>
40751190	19	<b>550</b>
40751200	20	<b>550</b>
40751210	21	<b>550</b>
40751220	22	<b>650</b>
40751230	23	<b>690</b>
40751240	24	<b>690</b>
40751250	25	<b>690</b>
40751260	26	<b>850</b>
40751270	27	<b>850</b>
40751280	28	<b>850</b>
40751290	29	<b>850</b>
40751300	30	<b>850</b>
40751320	32	<b>850</b>
40751340	34	<b>990</b>

1  
2  
3  
4  
5  
6  
7  
8  
9  
10

### KOKE KRIKETI 3/4" ME 6 FAQE



**5075**

Kodi	Permasa	Çmimi
50750190	19	<b>1.450</b>
50750240	24	<b>1.590</b>
50750270	27	<b>1.590</b>
50750300	30	<b>1.690</b>
50750320	32	<b>1.750</b>
50750330	33	<b>1.990</b>
50750340	34	<b>2.190</b>
50750360	36	<b>2.490</b>
50750380	38	<b>2.790</b>
50750410	41	<b>2.990</b>
50750460	46	<b>3.790</b>
50750500	50	<b>4.390</b>
50750550	55	<b>4.990</b>
50750600	60	<b>4.900</b>

### KOKE KRIKETI 3/4" ME 12 FAQE



**5075**

Kodi	Permasa	Çmimi
50751190	19	<b>1.390</b>
50751220	22	<b>1.390</b>
50751240	24	<b>1.450</b>
50751270	27	<b>1.550</b>
50751300	30	<b>1.650</b>
50751320	32	<b>1.750</b>
50751330	33	<b>1.750</b>
50751340	34	<b>1.790</b>
50751360	36	<b>2.500</b>
50751380	38	<b>2.500</b>
50751410	41	<b>2.890</b>
50751460	46	<b>3.390</b>
50751500	50	<b>3.500</b>
50751550	55	<b>4.500</b>
50751600	60	<b>5.500</b>

### KOKE KRIKETI 1" ME 12 FAQE



**6075**

Kodi	Permasa	Çmimi
60750360	36	<b>4.500</b>
60750002	41	<b>4.500</b>
60750460	46	<b>5.500</b>
60750004	50	<b>5.500</b>

### KOKE KRIKETI 1" ME 12 FAQE



**6075**

Kodi	Permasa	Çmimi
60750600	60	<b>6.990</b>
60750700	70	<b>8.500</b>
60750750	75	<b>9.500</b>
60750800	80	<b>9.900</b>

### KOKE KRIKETI E GJATE 1/2" ME 6 FAQE

**4081**

Kodi	Permasa	Çmimi
40810100	10	<b>1.350</b>
40810110	11	<b>1.350</b>
40810120	12	<b>1.350</b>
40810130	13	<b>1.350</b>
40810140	14	<b>1.350</b>
40810150	15	<b>1.350</b>
40810160	16	<b>1.350</b>
40810170	17	<b>1.450</b>
40810180	18	<b>1.450</b>
40810190	19	<b>1.490</b>
40810210	21	<b>1.650</b>
40810220	22	<b>1.690</b>
40810240	24	<b>1.790</b>
40810270	27	<b>1.900</b>
40810300	30	<b>1.900</b>
40810320	32	<b>1.900</b>

### KOKE KRIKETI E 1/2"

**4090**

Kodi	Permasa	Çmimi
40900100	E10	<b>1.150</b>
40900120	E12	<b>1.150</b>
40900140	E14	<b>1.150</b>

### KOKE KRIKETI E GJATE 1/2" ME 12 FAQE

**4081**

Kodi	Permasa	Çmimi
40811100	10	<b>1.500</b>
40811110	11	<b>1.500</b>
40811120	12	<b>1.500</b>
40811130	13	<b>1.500</b>
40811140	14	<b>1.750</b>
40811150	15	<b>1.750</b>
40811160	16	<b>1.790</b>
40811170	17	<b>1.790</b>
40811190	19	<b>1.790</b>
40811210	21	<b>1.990</b>
40811220	22	<b>1.990</b>
40811240	24	<b>2.290</b>
40811270	27	<b>2.390</b>
40811300	30	<b>2.590</b>
40811320	32	<b>2.590</b>

### KOKE KRIKETI E 1/2"

**4090**

Kodi	Permasa	Çmimi
40900160	E16	<b>1.150</b>
40900180	E18	<b>1.150</b>
40900200	E20	<b>1.150</b>



## PIPO TORX ME VRIME



**4093**

Kodi	Permasa	Çmimi
40930200	T20 x 60	<b>1.490</b>
40930250	T25 x 60	<b>1.490</b>
40930270	T27 x 60	<b>1.490</b>
40930300	T30 x 60	<b>1.490</b>
40930400	T40 x 60	<b>1.590</b>
40930450	T45 x 60	<b>1.590</b>
40930500	T50 x 60	<b>1.590</b>
40930550	T55 x 60	<b>1.590</b>

## PIPO EXAGON 1/2"



**40780**

Kodi	Permasa	Çmimi
40780040	4	<b>950</b>
40780050	5	<b>950</b>
40780060	6	<b>950</b>
40780070	7	<b>950</b>
40780080	8	<b>990</b>
40780100	10	<b>990</b>
40780120	12	<b>990</b>
40780140	14	<b>990</b>
40780170	17	<b>1.150</b>
40780190	19	<b>1.150</b>
40781050	M5 x 100	<b>1.150</b>
40781060	M6 x 100	<b>1.150</b>

## PIPO EXAGON 1/2" TE GJATA



**40781**

Kodi	Permasa	Çmimi
40781070	M7 x 100	<b>1.150</b>
40781080	M8 x 100	<b>1.150</b>
40781100	M10 x 100	<b>1.150</b>
40781120	M12 x 100	<b>1.250</b>
40781140	M14 x 100	<b>1.250</b>

## PIPO ME SHLICA 1/2"



**40790**

Kodi	Permasa	Çmimi
40790050	M5 x 60	<b>1.250</b>
40790060	M6 x 60	<b>1.250</b>
40790080	M8 x 60	<b>1.250</b>
40790100	M10 x 60	<b>1.250</b>
40790120	M12 x 60	<b>1.550</b>
40790140	M14 x 60	<b>1.900</b>
40790160	M16 x 60	<b>1.900</b>

## PIPO ME SHLICA 1/2" XZN TE GJATA



**40791**

Kodi	Permasa	Çmimi
40791050	M5 x 100	<b>1.450</b>
40791060	M6 x 100	<b>1.450</b>
40791080	M8 x 100	<b>1.450</b>
40791100	M10 x 100	<b>1.650</b>
40791120	M12 x 100	<b>1.850</b>
40791140	M14 x 100	<b>1.850</b>
40791160	M16 x 100	<b>1.950</b>

**PIPO TORX 1/2"**

**4092**

Kodi	Permasa	Çmimi
40920200	T 20	<b>1.150</b>
40920250	T 25	<b>1.150</b>
40920270	T 27	<b>1.150</b>
40920300	T 30	<b>1.150</b>
40920400	T 40	<b>1.150</b>
40920450	T 45	<b>1.390</b>
40920500	T 50	<b>1.490</b>
40920550	T 55	<b>1.550</b>
40920600	T 60	<b>1.590</b>

**ZGJATUES AJRI 1/2" 3/4" / 1"**

**2065**

Kodi	Permasa	Çmimi
74650001	1/2" x 75	<b>950</b>
75650001	3/4" x 150	<b>2.900</b>
75650002	3/4" x 250	<b>3.690</b>
75650003	3/4" x 400	<b>3.500</b>
76650001	1" x 150	<b>3.900</b>

**ADAPTOR AJRI**

**7483**

Kodi	Permasa	Çmimi
74830001	1/2" F - 3/4M	<b>2.200</b>
75830001	3/4" F - 1"M	<b>2.200</b>

**PIPO TORX 1/2" TE GJATA**

**40921**

Kodi	Permasa	Çmimi
40921200	T 20 x 100	<b>1.850</b>
40921250	T 25 x 100	<b>1.850</b>
40921270	T 27 x 100	<b>1.950</b>
40921300	T 30 x 100	<b>1.950</b>
40921400	T 40 x 100	<b>1.950</b>
40921450	T 45 x 100	<b>1.950</b>
40921500	T 50 x 100	<b>1.990</b>
40921550	T 55 x 100	<b>1.990</b>
40921600	T 60 x 100	<b>1.990</b>
40921700	T 70 x 100	<b>1.990</b>

**KOKE KRIKETI PER DADICEKE E VESHUR 1/2" 21 MM**

**7481**

Kodi	Permasa	Çmimi
74811210	1/2" 21 mm	<b>3.390</b>

**ADAPTOR AJRI**

**7482**

Kodi	Permasa	Çmimi
74820001	3/8" M - 1/2" F	<b>1.490</b>
75820001	3/4" F - 1/2" M	<b>1.900</b>
76820001	1" F - 3/4" M	<b>2.500</b>

## KOKE KRIKETI AJRI 1/2"



**7475**

Kodi	Permasa	Çmimi
74750100	10	<b>590</b>
74750110	11	<b>590</b>
74750120	12	<b>590</b>
74750130	13	<b>620</b>
74750140	14	<b>620</b>
74750150	15	<b>890</b>
74750160	16	<b>890</b>
74750170	17	<b>890</b>
74750180	18	<b>890</b>
74750190	19	<b>890</b>
74750200	20	<b>890</b>
74750210	21	<b>890</b>
74750220	22	<b>950</b>
74750240	24	<b>950</b>
74750270	27	<b>1.090</b>
74750300	30	<b>1.250</b>
70550032	32	<b>1.250</b>

## KOKE KRIKETI AJRI 1"



Kodi	Permasa	Çmimi
76750190	19	<b>2.500</b>
76750220	22	<b>2.500</b>
76750240	24	<b>3.500</b>
76750270	27	<b>2.500</b>
76750300	30	<b>2.500</b>

Kodi	Permasa	Çmimi
76750320	32	<b>2.690</b>
76750330	33	<b>2.690</b>
76750360	36	<b>2.800</b>
76750380	38	<b>2.990</b>
76750410	41	<b>3.500</b>
76750460	46	<b>3.590</b>
76750500	50	<b>4.500</b>
76750550	55	<b>5.500</b>
76750600	60	<b>6.900</b>
76750650	65	<b>7.900</b>
76750700	70	<b>8.900</b>

## KOKE KRIKETI AJRI 3/4"



**7575**

Kodi	Permasa	Çmimi
75750170	17	<b>1.590</b>
75750180	18	<b>1.690</b>
75750190	19	<b>1.690</b>
75750220	22	<b>1.890</b>
75750240	24	<b>1.890</b>
75750270	27	<b>1.890</b>
75750300	30	<b>1.990</b>
75750320	32	<b>2.090</b>
75750330	33	<b>2.290</b>
75750360	36	<b>2.500</b>
75750380	38	<b>2.500</b>
75750410	41	<b>2.500</b>
75750460	46	<b>2.900</b>
75750500	50	<b>3.900</b>
75750550	55	<b>3.900</b>
75750600	60	<b>4.500</b>
75750650	65	<b>4.750</b>



**KOKE KRIKETI AJRI 1/2" E GJATE**

**7481**

Kodi	Permasa	Çmimi
74810100	10 x 78	<b>990</b>
74810110	11 x 78	<b>990</b>
74810120	12 x 78	<b>990</b>
74810130	13 x 78	<b>1.090</b>
74810140	14 x 78	<b>1.190</b>
74810150	15 x 78	<b>1.190</b>
74810160	16 x 78	<b>1.190</b>
74810170	17 x 78	<b>1.190</b>
74810180	18 x 78	<b>1.190</b>
74810190	19 x 78	<b>1.350</b>
74810200	20 x 78	<b>1.350</b>
74810210	21 x 78	<b>1.350</b>
74810220	22 x 78	<b>1.350</b>
74810240	24 x 78	<b>1.350</b>
74810270	27 x 78	<b>1.690</b>
74810300	30 x 78	<b>1.690</b>
74810320	32 x 78	<b>1.690</b>

**KOKE KRIKETI AJRI 3/4" E GJATE**

**7581**

Kodi	Permasa	Çmimi
75810170	17 x 90	<b>2.500</b>
75810180	18 x 90	<b>2.500</b>
75810190	19 x 90	<b>2.500</b>
75810220	22 x 90	<b>2.500</b>

**KOKE KRIKETI AJRI 3/4" E GJATE**

**7581**

Kodi	Permasa	Çmimi
75810240	24 x 90	<b>2.500</b>
75810270	27 x 90	<b>2.500</b>
75810300	30 x 90	<b>2.690</b>
75810320	32 x 90	<b>2.690</b>
75810330	33 x 90	<b>3.290</b>
75810360	36 x 90	<b>3.290</b>
75810380	38 x 90	<b>3.290</b>
75810410	41 x 90	<b>3.490</b>
75810460	46 x 90	<b>3.590</b>
75810500	50 x 90	<b>6.500</b>

**KOKE KRIKETI 1" AJRI E GJATE**

**7681**

Kodi	Permasa	Çmimi
76810190	19	<b>2.890</b>
76810300	30	<b>2.990</b>
76810320	32	<b>3.200</b>
76810330	33	<b>3.200</b>
76810360	36	<b>3.500</b>
76810380	38	<b>4.900</b>
76810410	41	<b>4.900</b>
76810460	46	<b>4.900</b>
76810500	50	<b>5.500</b>
76810550	55	<b>5.990</b>

### PIPO TORX AJRI 1/2"



**7492**

Kodi	Permasa	Çmimi
74920550	TX55	<b>1.490</b>
74920600	TX60	<b>1.990</b>

### KOMPLET ÇFILETUES VIDASH



**0771**

Kodi	Permasa	Çmimi
07710001	M3 - M18, 1/8 - 3/4"	<b>1.550</b>
07710002	M3 - M24, 1/8 - 1"	<b>2.350</b>
07710003	M3 - M45	<b>5.500</b>

### SHARRE DORE HEKURI PROFI



**0786**

Kodi	Permasa	Çmimi
07860003	300	<b>390</b>

### SHARRE DORE HEKURI PROFI



**0787**

Kodi	Permasa	Çmimi
07870003	150	<b>120</b>

### KAÇAVIDE PER VIDA TE PRISHURA



**0770**

Kodi	Permasa	Çmimi
07700002	500	<b>2.900</b>

### KAÇAVIDE ME KOKE 1/4"



**2073**

Kodi	Permasa	Çmimi
20730001	1/4"x150 mm	<b>990</b>

### DALTE E SHESHTE PER HEKUR



**0714**

Kodi	Permasa	Çmimi
07140125	125	<b>890</b>
07140200	200	<b>1.290</b>

### SET ME 5 DALTA TE SHESHTA



**0714**

Kodi	Permasa	Çmimi
07149050	125 - 150 - 175 - 200 - 250	<b>5.900</b>

### SPECIMETER ME DOREZE MBROJTJESË



**0760**

Kodi	Permasa	Çmimi
07600002	13 (0,05-1.00)	<b>1.150</b>
07600003	20 (0,05-1.00)	<b>1.150</b>
07600006	20 (2-40/1.00)	<b>950</b>

### SPECIMETER PER MATJEN E FILETOVE METRIKE DHE WHITWORTIT



**0764**

Kodi	Permasa	Çmimi
07640001	M 0.25-6.00	<b>990</b>
07640003	M+W 0.25-6.00 + 4-62	<b>1.990</b>

### LIMA HEKURI

**0775 6**

Kodi	Permasa	Çmimi
07750001	150	<b>850</b>
07750002	150	<b>850</b>
07750003	150	<b>850</b>
07750004	150	<b>850</b>
07750005	150	<b>1.190</b>
07750010	200	<b>1.190</b>
07750011	200	<b>1.190</b>
07750012	200	<b>1.190</b>
07750013	200	<b>1.250</b>
07750014	200	<b>1.450</b>
07760001	250	<b>1.490</b>
07760002	250	<b>1.890</b>
07760003	250	<b>1.390</b>
07760004	250	<b>1.490</b>
07760005	250	<b>1.990</b>



### KOMPLET LIMASH HEKURI

**0775 8**

Kodi	Permasa	Çmimi
07780002	200	<b>3.990</b>
	200	
	200	
	200	
	200	

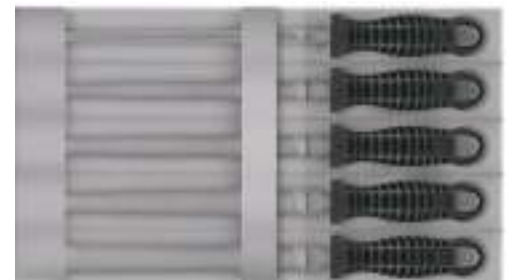



## PISTOLETE DADIÇEKESH 1/2"



**7000**

Kodi	Shtrengimi	Çmimi
70000001	1.490 Nm	<b>32.900</b>

## ÇEKIC GOME ME BISHT DRURI



**0700**

Kodi	Pershkrimi	Çmimi
07000003	350 gr	<b>1.450</b>
07000004	450 gr	<b>2.200</b>
07000005	600 gr	<b>2.500</b>

## INDIKATOR MAKINE PER SIGURESIA



**0633**

Kodi	Tensioni	Çmimi
06330001	60-24 V	<b>990</b>

## PISTOLETE GRASATIMI 500 CC + ADAPTOR



**0794**

Kodi	Pershkrimi	Çmimi
07940001	Set komplet (A)	<b>4.500</b>
07940002	Koka Hidraulike(B)	<b>990</b>
07940003	Adaptor 150 mm(C)	<b>550</b>

## SET ME 6 KACAVIDA (VDE)



**0681**

1000 V  
A▲G

Kodi	Pershkrimi	Çmimi
06811001	0616 - 2.5x75-3.5x100 -5.5x125 0635 0.5x3.0 mm 0656 PH1-PH2	<b>4.990</b>

## INDIKATOR PER MAKINA 6-24 V



Kodi	Çmimi
4518	<b>590</b>

## Per kapje me te mire. Pince universale mekanike



**0500**

### Pince universale mekanike

- Forme Amerikane
- Per prerjen e telave te forte dhe te bute
- Tehe prerese te temperuar
- Nofulla simetrike per kapje me te mire
- Shtrengim perfekt per materiale te sheshta dhe rrethore
- Mbajtese gozhde dhe teli
- Unaze rrethore te integruar
- Fuqi e transmetuar ne menyre perfekte per prerje pa lodhje
- Doreze ergonomike me 2 komponente
- Standarti Din ISO 5746
- Materiali Celik
- Siperfaqe Finiture e kromuar mat

Kodi	l mm	l"	mm	mm	mm	mm	Gr	Pk	Cmimi
05000165	165	6.1/2	4.0	3.1	2.0	10	200	6	<b>1.990</b>
05000180	180	7	5.2	3.4	2.2	12	255	6	<b>2.100</b>
05000205	205	8	5.9	3.8	2.5	13	285	6	<b>2.400</b>



## 0532 Tronkeze universale mekanike

- Per prerje kabulli te bute dhe te forte
  - Prerje precize edhe per kabullin me te holle
  - Tehe prerese te temperuar
  - Fortesia e prerjes deri ne 62 HRC
  - Fuqi e transmetuar ne menyre perfekte per pune pa lodhje
  - Doreze ergonomike me 2 komponente
- Standarti Din ISO 5749
  - Materiali Celik
  - Siperfaqe Finiture e kromuar mat

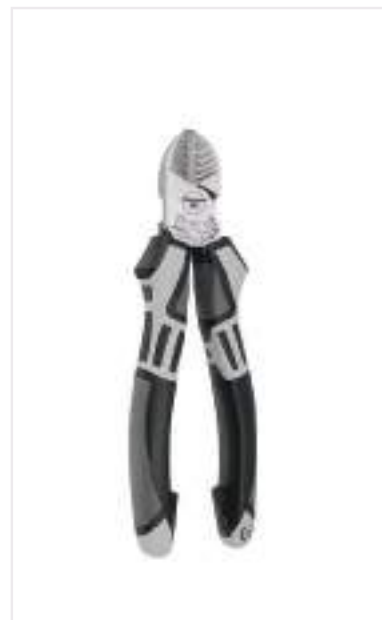

Kodi	I mm	I"	mm	mm	mm	mm	Gr	Pk	Cmimi
05320145	145	5.3/4	5	2.5	1.7	8	180	6	<b>2.500</b>
05320160	160	6.1/4	6	3.5	2.0	11	210	6	<b>2.700</b>
05320180	180	7	7	4.0	2.5	13	265	6	<b>2.900</b>

## 0585 Pince mekanike me maje te drejte



- Maja te sheshta, gjata dhe te drejta
  - Hapesire per mbajtje gozhde dhe presese
  - Nofulla te dhembzuara
  - Per prerje kabulli te bute dhe te forte
  - Per kapje dhe shtrengim
- Standarti Din ISO 5745
  - Materiali Celik i temperuar
  - Siperfaqe Finiture e kromuar mat

Kodi	I mm	I"	mm	mm	mm	mm	g	Pk	Cmimi
05850170	170	6.3/4	2.5	1.6	-	15	170	6	<b>2.700</b>
05850205	205	8	5.2	3.4	2.2	12	255	6	<b>3.200</b>

## 0586 Pince mekanike me maje te kthyer



- Maja te sheshta, gjata te kthyer 45°
  - Hapesire per mbajtje gozhde dhe presese
  - Nofulla te dhembzuara
  - Per prerje kabulli te bute dhe te forte
  - Per kapje dhe shtrengim
- Standarti Din ISO 5745
  - Materiali Celik i temperuar C45
  - Siperfaqe Finiture e kromuar mat

Kodi	I mm	I"	mm	mm	mm	mm	Gr	Pk	Cmimi
05860205	205	8	3.9	3.2	2.2	18	215	6	<b>3.500</b>





E pershtashme per prerjen dhe lidhjen e telave



Performance e larte ne prerje



Ideale per prerjen e gozhdeve

## 0536 Dare karpentieri me koke te gjere te veshur



- Per prerjen e telave te bute te bute dhe te forte
- E pershtatshme per lidhjen e rretave
- Nofulla te perforcuara dhe te temperuara
- Fuqi e transmetuar ne menyre perfekte per pune pa lodhje
- Doreza ergonomike

- Standarti: **DIN / ISO 5748**
- Materiali: Celik
- Siperfaqe: Finiture e kromuar Mat

Kodi	l mm	l "			mm	mm	mm	Gr	Pk	Cmimi
05360180	180	7			4.0	3.0	2.4	250	6	<b>2.290</b>
05360200	200	8			4.0	3.5	2.6	320	6	<b>2.890</b>

## 0546 Dare karpentieri e veshur



- Per prerjen e telave te bute te bute dhe te forte
- E pershtatshme per lidhjen e rretave
- Nofulla te perforcuara dhe te temperuara
- Fuqi e transemmetuar ne menyre perfekte per pune pa lodhje
- Doreza ergonomike

- Standarti: **DIN / ISO 5748**
- Materiali: Celik
- Siperfaqe: Finiture e kromuar Mat

Kodi	l mm	l "			mm	mm	mm	Gr	Pk	Cmimi
05460180	180	7			3	2.2	2.2	255	6	<b>2.250</b>
05460260	260	10 1/4			3.8	2.6	2.6	375	6	<b>2.690</b>
05460300	300	11 3/4			4	4	2.8	490	6	<b>3.200</b>

## 0546 Dare karpentieri e veshur



- Per prerjen e telave te bute te bute dhe te forte
- E pershtatshme per lidhjen e rretave
- Nofulla te perforcuara dhe te temperuara
- Fuqi e transemmetuar ne menyre perfekte per pune pa lodhje
- Doreza ergonomike

- Standarti: **DIN / ISO 5748**
- Materiali: Celik
- Siperfaqe: Finiture e kromuar Mat

Kodi	l mm	l "			mm	mm	mm	Gr	Pk	Cmimi
05460230	230	9			3.4	2.4	2.4	300	6	<b>2.490</b>



## 0556 Celes Hidraulik

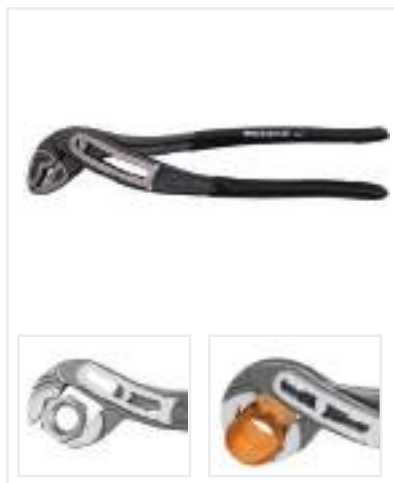

- Pince hidraulike me kapje te perforcuar per me shume tension
- Kapje mbi 40% mbi normen ISO fale dorezes se harkuar
- Ingranazh ne forme gjysem rrethi per bllokim te shpejte
- Nofulla te perforcuara

- Standarti Din ISO 8976
- Materiali Chrome Vanadium

Kodi	l mm	l"	mm	"	Gr	Pk	Cmimi
05560180	180	7	40	1.1/4	155	1	<b>2.300</b>
05560240	240	9.1/2	50	2.1/4	350	1	<b>2.600</b>
05560400	400	15.3/4	100	3.1/2	1025	1	<b>5.600</b>

## 0557 Celes Hidraulik PRO



- Rregullim automatik i hapjes
- Forme kompakte per te punuar edhe ne zonat me te ngushta
- Mbajttese gozhde dhe kabelli
- Kapje mbi 40% mbi normen ISO fale dorezes se harkuar
- Ingranazh ne forme gjysem rrethi per bllokim te shpejte
- Nofulla te perforcuara
- Pershatje e shpejte me objektin per kapje fale hapjes automatike

- Standarti Din ISO 8976
- Materiali Chrome Vanadium

Kodi	l mm	l"	mm	"	Gr	Pk	Cmimi
05570250	250	10	50	2.1/4	360	1	<b>3.300</b>
05570320	320	12.1/2	75	3	640	1	<b>4.900</b>
05570400	400	15.3/4	100	3.1/2	1255	1	<b>7.900</b>

# Kapje e shkelqyer

## Celes hidraulik Suedez



### 0596 Celes hidraulik Suedez 45°

- Celes ideal per shtrengimin e tubave
  - I holle dhe me kend 45°
  - Kapje deri ne 3 pozicione
  - I temperuar ne vaj
  - Per kapje dhe shtrengim
- Standarti Din ISO 5234
  - Materiali Chrom Vanadium
  - Siperfaqe Veshur me boje te kuqe



Kodi	"	mm	l mm	Gr	Pk	Cmimi
05960001	1/2	0-35	265	405	1	<b>4.500</b>
05960002	1	0-42	315	745	1	<b>5.500</b>
05960003	1.1/2	0-60	420	1380	1	<b>6.500</b>
05960004	2	0-70	430	2750	1	<b>9.900</b>

### 0597 Celes hidraulik Suedez 90°

- Patente Suedeze
  - Gjeresi e rregullueshme
  - Siguron kapje te gjere fale nofullave te perforcuara
  - Kapje ne 3 pozicione
  - Kapje automatike
  - I temperuar ne vaj
- Standarti Din ISO 5234
  - Materiali Chrom Vanadium
  - Siperfaqe Veshur me boje te kuqe



Kodi	"	l"	Cmimi	Gr	Pk
05970001	1	0-42	<b>5.500</b>	785	1
05970002	1.1/2	0-60	<b>6.500</b>	1400	1



Puno ne Tension.

**MATADOR VDE-Tools.**  
**Siguria e para.**

Prodhuar me plastike ngjyre te kuqe per me shume siguri rreth ferkimeve apo shkendijave.

Ngjyra e verdhe, e sigurte edhe ne pune me presion apo shtypje te larte.



Siguri me e larte fale gomines

**0500** Pince universale elektrike (VDE)

- Per prerjen e telave te bute te bute dhe te forte
- Tehe prerres te temperuar
- Kapje e mire e objekteve rrethoire
- Mbajttese teli dhe gozhde
- Mekanizem i integruar
- Transmetim i forces ne menyre efikase fale dorezave

- Doreza ergonomike me 2 komponente
- Materiali:
- Standarti:
- Siperfaqe:

Celik  
**DIN / ISO 5748**  
Izolim sipas normes:  
**IEC60900:2004**

Kodi	l mm	l "			mm	mm	mm	mm	Gr	Pk	Cmimi
05001165	165	6.1/2			4.0	3.1	2	10	200	6	<b>2.800</b>
05001180	180	7			5.2	3.4	2.2	12	255	6	<b>2.900</b>
05001205	205	8			5.9	3.8	2.5	13	285	6	<b>3.300</b>



**0532** Tronkeze elektrike (VDE)

- Per prerjen e telave te bute te bute dhe te forte
- Prerje precize per telat me te holle
- Tehe prerres te temperuar
- Fortesi tehu deri ne **62 HRC**
- Transmetimi i forces ne menyre efikase fale dorezave
- Doreza ergonomike me 2 komponente

- Standarti:
- Materiali:
- Siperfaqe:

**DIN / ISO 5749**  
Celik  
Izolim sipas normes:  
**IEC60900:2004**

Kodi	l mm	l "			mm	mm	mm	mm	Gr	Pk	Cmimi
05321145	145	5.3/4			5	2.5	1.7	8	180	6	<b>2.900</b>
05321160	160	6.1/4			6	3.5	2	10	210	6	<b>3.300</b>



**0576 Zhveshese teli elektrike (VDE)**

- Me vide per regjistrim
- Mekanizem i integruar
- Per tela deri ne 6mm Ø
- Per tela te bute dhe te forte

- Materiali: Celik i temperuar **C 45**
- Siperfaqe: Izolim sipas normes IEC 60900:2004

Kodi	l mm	l "	mm	mm <sup>2</sup>	Ø mm	Gr	Pk	Cmimi
05761160	160	6.1/4		10	5	185	6	<b>2.900</b>

**0585 Pinca elektrike me maje te drejte (VDE)**

- Nofulla te gjata dhe rrethore
- Me mbajtese gozhde dhe prerese
- Nofulla te dhembazuara
- Per tela te bute dhe te forte

- Standarti: **DIN / ISO 5745**
- Materiali: Celik i temperuar **C 45**
- Siperfaqe: Izolim sipas normes IEC 60900:2004

Kodi	l mm	l "	mm	mm	mm	Gr	Pk	Cmimi
05851170	170	6.3/4	15	2.5		170	6	<b>3.300</b>
05851205	205	8	18	3.9	2.2	215	6	<b>3.600</b>

**0586 Pinca elektrike me majte te kthyer (VDE)**

- Nofulla te gjata dhe rrethore 45°
- Me mbajtese gozhde dhe prerese
- Nofulla te dhembazuara
- Per tela te bute dhe te forte

- Standarti: **DIN / ISO 5745**
- Materiali: Celik i temperuar **C 45**
- Siperfaqe: Izolim sipas normes IEC 60900:2004

Kodi	l mm	l "	mm	mm	mm	mm	Gr	Pk	Cmimi
05861205	205	6.3/4	18	3.9	3.2	2.2	215	6	<b>3.600</b>

**0829 Prerese kabulli (VDE)**

- Per prerje dhe zhveshje kabulli baker ose alumin deri Ø 16mm (50 mm<sup>2</sup>)
- Bashkim i rregullueshem

- Standarti: **DIN / ISO 5745**
- Materiali: Celik i temperuar **C 45**
- Siperfaqe: Izolim sipas normes IEC 60900:2004



Kodi	l mm	l "	mm <sup>2</sup>	Ø mm	mm	Gr	Pk	Cmimi
08291160	160	6.1/4	50	16	2.2	225	6	<b>4.400</b>

## Pinca per fermo

Matja precize te temperuara dhe doreza antirreshkitje



3 - 140 mm

**0578**

### Pince fermo per hapje me maje te drejte

- Per vendosjen e fermove ne aks, prodhuar sipas standarteve DIN 471 dhe DIN 983
- Te temperuara
- Me maje te drejte per hapjen e fermove
- Doreza antirreshkitje me maja pecize
- Doreza te veshura

- Standarti: DIN ISO 5254-B
- Materiali: Chrome Vanadium

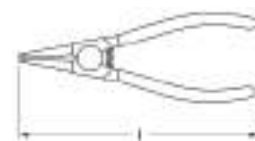

Kodi	Permase	mm	l"	mm	mm	mm	Gr	Pk	Cmimi
05780010	A1	135	5.1/4	10	25	1.3	100	6	<b>1.850</b>
05780020	A2	180	7	19	60	1.8	150	6	<b>1.850</b>
05780030	A3	220	8.3/4	40	100	2.3	250	6	<b>2.390</b>
05780040	A4	310	12.1/7	85	140	3.2	500	6	<b>3.690</b>

**0580**

### Pince fermo per hapje me maje te kthyer

- Per vendosjen e fermove ne aks, prodhuar sipas standarteve DIN 471 dhe DIN 983
- Te temperuara
- Me kend 90 grade per hapjen e fermove
- Doreza antirreshkitje me maja pecize
- Doreza te veshura

- Standarti: DIN ISO 5254-B
- Materiali: Chrome Vanadium

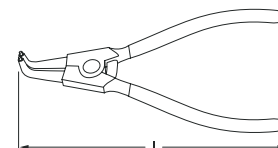

Kodi	Permase	mm	l"	mm	mm	mm	Gr	Pk	Cmimi
05800110	A11	125	5	10	25	1.3	100	6	<b>1.990</b>
05800210	A21	165	6.1/2	19	60	1.8	150	6	<b>2.150</b>
05800310	A31	200	7.3/4	40	100	2.3	250	6	<b>2.590</b>
05800410	A41	290	11.1/2	85	140	3.2	500	6	<b>3.990</b>



## 0582

### Pince fermo per mbyllje me maje te drejte

- Per vendosjen e fermove ne aks, prodhuar sipas standarteve DIN 472 dhe DIN 984
- Standarti: DIN ISO 5254-C
- Materiali: Chrome Vanadium
- Te temperuara
- Me maje te drejte per hapjen e fermove
- Doreza antirreshkitje me maja pecize
- Doreza te veshura

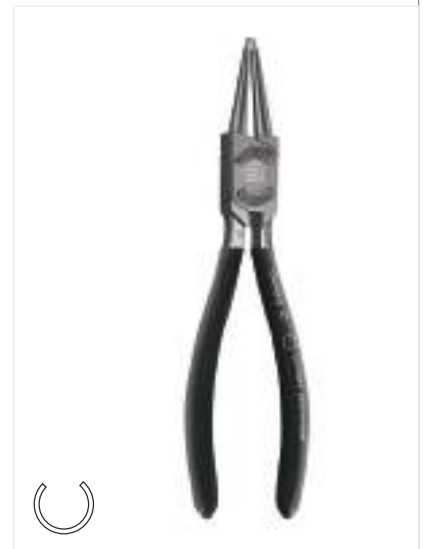
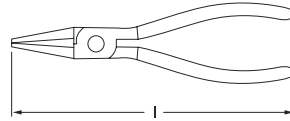

Kodi	Permasa mm	I"	mm	mm	mm	Gr	Pk	Cmimi	
05820010	J1	135	5.1/4	10	25	1.3	100	6	<b>1.850</b>
05820020	J2	180	7	19	60	1.8	150	6	<b>1.890</b>
05820030	J3	220	8.3/4	40	100	2.3	250	6	<b>2.490</b>
05820040	J4	310	12.1/4	85	140	3.2	500	6	<b>3.590</b>

## 0584

### Pince fermo per mbyllje me maje te kthyer

- Per vendosjen e fermove ne aks, prodhuar sipas standarteve DIN 472 dhe DIN 984
- Standarti: DIN ISO 5254-d
- Materiali: Chrome Vanadium
- Te temperuara
- Me kend 90 grade per hapjen e fermove
- Doreza antirreshkitje me maja pecize
- Doreza te veshura

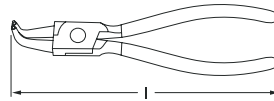

Kodi	Permasa mm	I"	mm	mm	mm	Gr	Pk	Cmimi	
05840110	J11	125	5	10	25	1.3	100	6	<b>1.850</b>
05840210	J21	165	6.1/2	19	60	1.8	150	6	<b>1.890</b>
05840310	J31	200	7.3/4	40	100	2.3	250	6	<b>2.390</b>
05840410	J41	290	11.1/2	85	140	3.2	500	6	<b>3.690</b>

## 0589

### Pince morsete me nofull te gjere

- Ideale per servise apo marangoze
- Siperfaqja: E nikuluar
- Materiali: Chrome Vanadium
- Te temperuara
- Me nofulla te levizshme

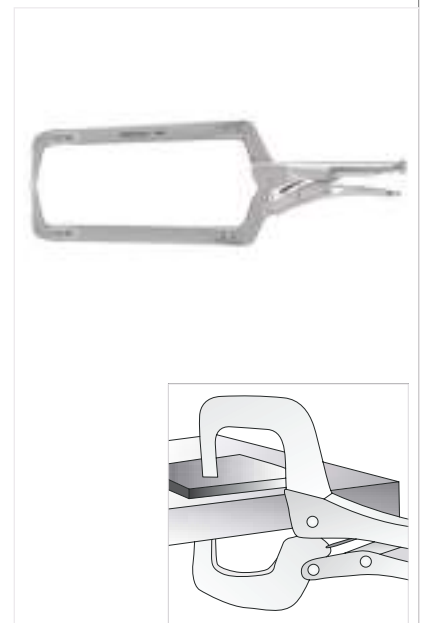
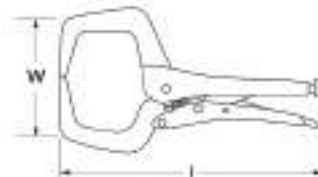

Kodi	Permasa mm	I"	Gr	Pk	Cmimi		
05890280	280	11	90	0-100	710	1	<b>4.900</b>

# Celesa hexagon L

Plotesisht te galvanizuar, sipërfaqe e trajtuar me nikel dhe chrome per jetegjatesi nga korrozioni.

Numra te qarte te qendrueshem



Me koke te rumbullaket per pune te veshitura me kend 25°

Prodhuar nga aliazhe Chrome Vanadium per rezistence sa me te larte

## 0440 Çeles i shkurter - L (Hexagon)

- Çeles hexagon i shkurter per vida
- Standarti: DIN ISO 2936
- me koke te mbrendshme hexagon
- Materiali: Chrome Vanadium
- Te temperuara
- Finitura e kromuar
- Ngjyra mat

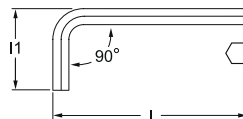

Kodi	mm	l mm	l1 mm	Gr	Pk	Çmimi
04400020	2.0	50	16	2	10	<b>50</b>
04400025	2.5	57	19	3	10	<b>60</b>
04400030	3.0	64	21	5	10	<b>70</b>
04400040	4.0	72	27	10	10	<b>80</b>
04400050	5.0	83	31	18	10	<b>100</b>
04400060	6.0	94	36	30	10	<b>140</b>
04400070	7.0	100	39	43	10	<b>190</b>
04400080	8.0	105	42	60	10	<b>250</b>
04400100	10.0	120	48	105	10	<b>350</b>
04400120	12.0	133	55	170	10	<b>550</b>
04400140	14.0	152	68	265	5	<b>750</b>
04400170	17.0	174	78	442	5	<b>1.290</b>
04400190	19.0	195	87	631	5	<b>1.590</b>

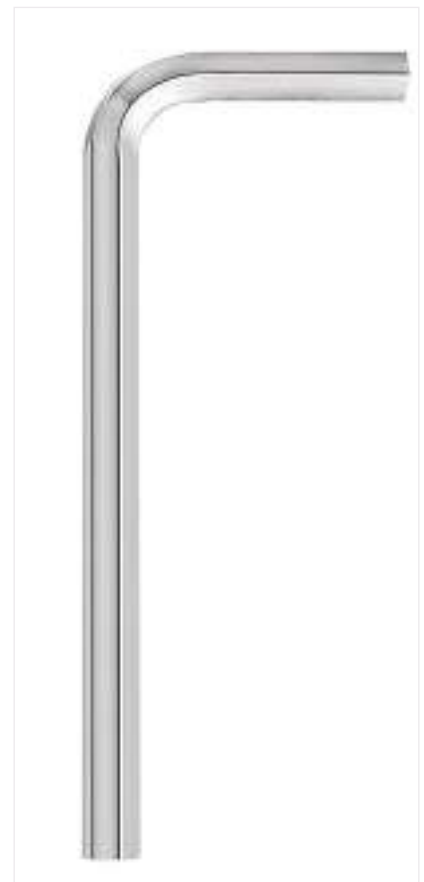

## 0441 Çeles i gjate - L (Hexagon)

- Çeles hexagon i shkurtër për vida me koke të mbrendshme hexagon
- Standarti: DIN ISO 2936
- Materiali: Chrome Vanadium
- Te temperuara
- Finitura e kromuar
- Ngjyra mat

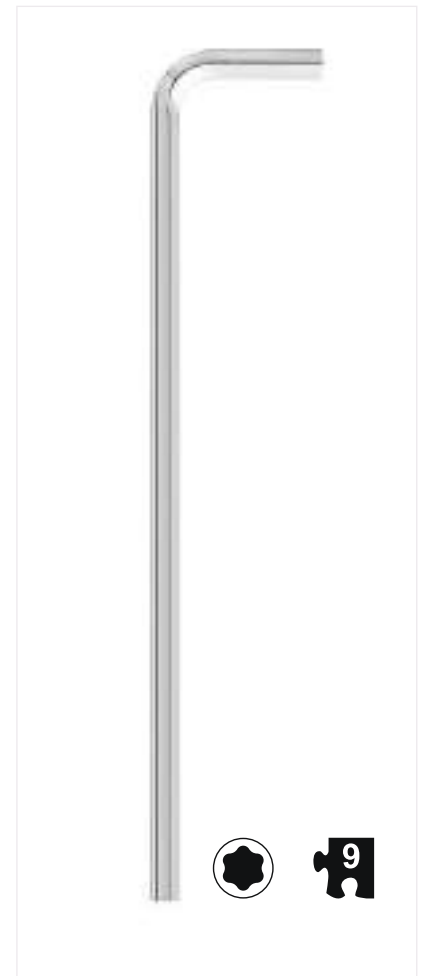
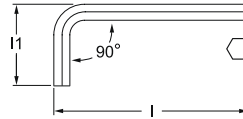

Kodi	mm	l mm	l1 mm	Gr	Pk	Çmimi
04410020	2.0	100	16	4	10	<b>80</b>
04410025	2.5	112	19	5	10	<b>100</b>
04410030	3.0	127	21	5	10	<b>120</b>
04410040	4.0	142	27	8	10	<b>150</b>
04410050	5.0	163	31	30	10	<b>210</b>
04410060	6.0	184	36	50	10	<b>290</b>
04410080	8.0	206	42	100	10	<b>390</b>
04410100	10.0	232	48	180	10	<b>590</b>
04410120	12.0	258	61	280	5	<b>790</b>
04410140	14.0	290	68	450	5	<b>1.290</b>
04410170	17.0	333	78	750	5	<b>1.790</b>
04410190	19.0	375	87	1275	5	<b>2.490</b>

## 0444 Set celesash te shkurtër - L (Torx)

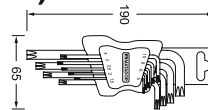

Kodi	Çmimi	Pk
04449090	<b>5.590</b>	1



## 0716/8/9 Set me dalta dhe bulino

- Set me dalta me mbajtëse plastike
- Standarti: DIN 6458 B/D
- Per te lene shenje ne materiale metalike
- Materiali: Chrome Vanadium
- Siperfaqe e lemuar me maje
- Me bosht 8 këndor
- Maje e temperuar

Kodi	Gr	Pk	Çmimi
07169060	716 2-3-4-5-6-8 mm	1 1500	<b>2.750</b>
07189060	0718 2-3-4-5-6-8 mm	1 800	<b>2.990</b>
07199060	714 125,150 mm 0717 4 mm 0715 125 mm 0716 3,4 mm	1 550	<b>3.590</b>





## 0616 Kacavide elektrike - (VDE)



- Maje clesore prodhuar me celik special te temperuar
- Maje e mbrojtur ndaj kontaktit elektrik
- Doreze me 2 komponente
- Mbajtese me vrime
- Doreza te veshura

- Standarti: DIN ISO IEC 60900 2004
- Materiali: Chrome Vanadium

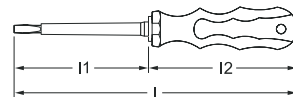

Kodi	mm	mm	L1 mm	L2 mm	L mm	Gr	Pk	Çmimi
06160635	0.6	3.5	100	95	195	47	10	<b>850</b>
06160840	0.8	4	100	105	105	63	10	<b>890</b>
06161055	1.0	5.5	125	105	230	96	10	<b>950</b>
06161265	1.2	6.5	150	120	270	119	10	<b>990</b>

## 0656 Kacavide elektrike PH (VDE)



- Maje clesore prodhuar me celik special te temperuar
- Maje e mbrojtur ndaj kontaktit elektrik
- Doreze me 2 komponente
- Mbajtese me vrime
- Doreza te veshura

- Standarti: DIN ISO IEC 60900 2004
- Materiali: Chrome Vanadium

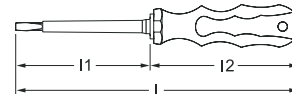

Kodi	mm	mm	L1 mm	L2 mm	L mm	Gr	Pk	Çmimi
06560000	5	PH 0	60	90	150	43	10	<b>890</b>
06560010	5	PH 1	80	100	180	68	10	<b>950</b>
06560020	6	PH 2	100	110	210	98	10	<b>990</b>

## 0635 Indikator elektrik / EURO (VDE)



- Per tension deri ne 230 V
- Maje e mbrojtur ndaj kontaktit elektrik
- Mbajtese metalike
- Tregues LED

- Standarti: DIN ISO VDE 0680
- Materiali: Chrome Vanadium

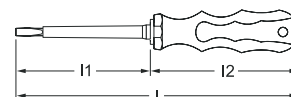

Kodi	mm	mm	L1 mm	L2 mm	L mm	Gr	Pk	Çmimi
020-100	0.6	3.5	100	95	195	40	10	<b>150</b>
020E-60	0.5	3.0	60	70	150	30	10	<b>250</b>
020E-100	0.6	3.5	100	90	190	35	10	<b>290</b>

## 0615 Kacavide mekanike me maje pete

- Maje cilesore prodhuar me celik special te temperuar
- Doreze me 2 komponente per me shume fortesi dhe butesi
- Mbajtese me vrime
- Maje e temperuar
- Standarti: DIN ISO 2380-2/1
- Materiali: Chrome Vanadium

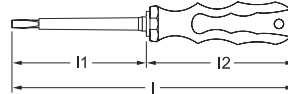

Kodi	mm	mm	L1 mm	L2 mm	L mm	Gr	Pk	Çmimi
06151055	1.0	5.5	125	105	230	70	10	<b>690</b>
06151265	1.2	6.5	150	105	255	85	10	<b>750</b>
06151280	1.2	8.0	175	120	295	128	5	<b>950</b>



## 0660 Kacavide precizioni me maje pete

- Kacavide precizioni per inxhinieret elektronike dhe per pune ne qarqe elektronike
- Doreze me 2 komponente per me shume fortesi dhe butesi
- Mbajtese me vrime
- Maje e temperuar
- Standarti: DIN ISO 2380-2/1
- Materiali: Chrome Vanadium

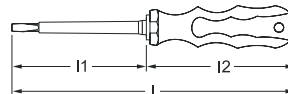

Kodi	mm	mm	L1 mm	L2 mm	L mm	Gr	Pk	Çmimi
06600425	0.4	2.5	75	85	160	33	10	<b>550</b>
06600530	0.5	3.0	100	85	185	35	10	<b>590</b>
06600840	0.8	4.0	100	95	195	50	10	<b>650</b>



## 0655 Kacavide mekanike (PH)

- Kacavide mekanike per vida me koke (PH)
- Doreze me 2 komponente per me shume fortesi dhe butesi
- Mbajtese me vrime
- Maje e temperuar
- Standarti: DIN ISO 8764
- Materiali: Chrome Vanadium

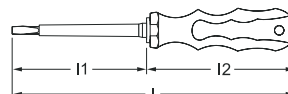

Kodi	mm	mm	L1 mm	L2 mm	L mm	Gr	Pk	Çmimi
06550000		PH 0	80	95	175	34	10	<b>590</b>
06550010		PH 1	80	95	175	34	10	<b>750</b>
06550020		PH 2	100	105	205	77	10	<b>790</b>
06550030		PH 3	150	120	270	145	10	<b>990</b>

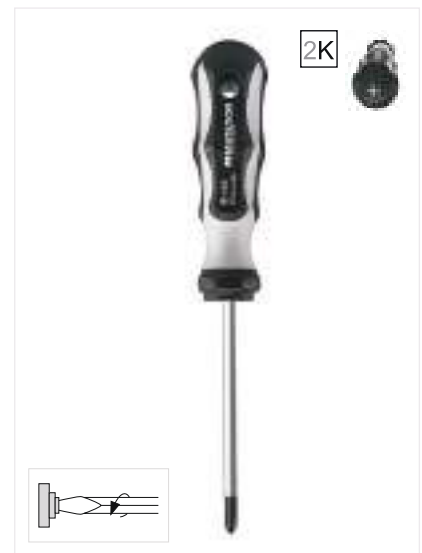

**0657**

**Kacavide mekanike (PZ)**

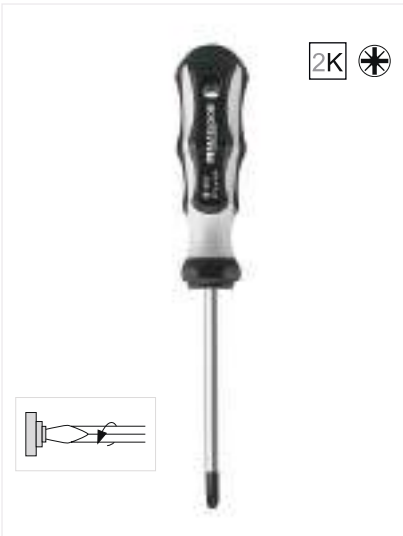

- Kacavide mekanike per vida me koke (PH)
- Doreze me 2 komponente per me shume fortesi dhe butesi
- Mbajtese me vrime
- Maje e temperuar

- Standarti: DIN ISO 8764
- Materiali: Chrome Vanadium

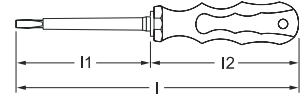

Kodi	Maja	L1 mm	L2 mm	L mm	Gr	Pk	Çmimi
06570000	PZ 0	80	95	175	34	10	<b>590</b>
06570010	PZ 1	80	95	175	34	10	<b>750</b>
06570020	PZ 2	100	105	205	77	10	<b>790</b>
06570030	PZ 3	150	120	270	145	10	<b>990</b>

**0620**

**Kacavide mekanike (TORX)**



- Kacavide mekanike per vida me koke (PH)
- Doreze me 2 komponente per me shume fortesi dhe butesi
- Mbajtese me vrime
- Maje e temperuar

- Standarti: DIN ISO 8764
- Materiali: Chrome Vanadium

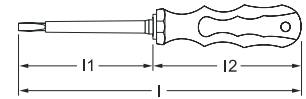

Kodi	Maja	L1 mm	L2 mm	L mm	Gr	Pk	Çmimi
06200080	T8	75	85	160	28	5	<b>650</b>
06200100	T10	75	95	175	37	5	<b>750</b>
06200150	T15	80	95	175	40	5	<b>790</b>
06200200	T20	100	95	195	44	5	<b>890</b>
06200250	T25	100	95	195	48	5	<b>890</b>
06200270	T27	115	105	220	71	5	<b>950</b>
06200300	T30	115	105	220	85	5	<b>990</b>

**0680**

**Set me kacavida mekanike 6 cope**

- Set me kacavida mekanike te pajisura me kuti
- Doreze me 2 komponente per me shume fortesi dhe butesi
- Maje e temperuar

- Standarti: DIN ISO 60900-2004
- Materiali: Chrome Vanadium

Kodi	L mm	Gr	Pk	Çmimi
06809060	6	520	1	<b>4.990</b>

0615 0.6x4.0x75 - 0.8x5.0x100 - 1.0x5.5x12 - 1.2x6.5x150 mm  
 0655 PH1x60 - PH2x100 mm





## Kaçavida profesionale Frico



**felo**  
Innovations



Kodi	Tipi	Permasa			Cmimi
50004710	500	4,0 x 0,8	200	4.00	<b>590</b>
50055410		5,5 x 1,0	125	5.00	<b>590</b>
50055710		5,5 x 1,0	200	5.00	<b>790</b>
50055910	E sheshte	5,5 x 1,0	300	5.00	<b>990</b>
50065510		6,5 x 1,2	150	6.00	<b>490</b>
50065710		6,5 x 1,2	200	6.00	<b>690</b>
50008610		8,0 x 1,2	175	8.00	<b>790</b>

**felo**  
Innovations



Kodi	Tipi	Permasa			Cmimi
	501				
50120710	Pozidriv	PZ2	200	6.0	<b>790</b>

**felo**  
Innovations



Kodi	Tipi	Permasa			Cmimi
	507				
50720340	Torx TR	TR20	100	6.0	<b>790</b>

Kodi	Tipi	Permasa			Cmimi
	502				
50210210	Philips	PH1	80	4.50	<b>490</b>
50210710		PH1	200	4.50	<b>590</b>
50220310		PH2	100	6.00	<b>590</b>
50220710		PH2	200	6.00	<b>790</b>
50220910		PH2	300	6.00	<b>990</b>

**felo**  
Innovations



Kodi	Tipi	Permasa			Cmimi
	508				
50810340	Torx	T10	100	3.50	<b>490</b>
50815340		T15	100	4.00	<b>490</b>
50825340		T25	100	5.00	<b>690</b>
50830340		T30	100	6.00	<b>890</b>



**made in Germany**  
since 1878

## Set me Kaçavida profesionale Frico

**felo**  
Innovations



Kodi	Sasia setit	Set me Kaçavida profesionale Frico	Cmimi
50095118	5	<ul style="list-style-type: none"> <li> 4.0 x 100</li> <li> 5.5 x 125</li> <li> 6.5 x 150mm</li> <li> PH1 x 80</li> <li> PH2 x 100mm</li> </ul>	<b>2.500</b>

**felo**  
Innovations



Kodi	Sasia setit	Set me Kaçavida profesionale Frico	Cmimi
50096117	6	<ul style="list-style-type: none"> <li> 3.5 x 100</li> <li> 4.0 x 100</li> <li> 5.5 x 125</li> <li> 6.5 x 150</li> <li> PH1 x 80</li> <li> PH2 x 100</li> </ul>	<b>2.300</b>

## Set me Kaçavida profesionale Frico

felo  
Innovations



Kodi	Sasia setit	Set me Kaçavida profesionale Frico	Cmimi
50096317	6	<ul style="list-style-type: none"> <li>⊖ 4.0 x 100</li> <li>⊖ 6.5 x 150</li> <li>⊕ PH1 x 80</li> <li>⊕ PH2 x 100</li> <li>⊕ PZ1 x 80</li> <li>⊕ PZ2 x 100</li> </ul>	<b>3.300</b>

felo  
Innovations



Kodi	Sasia setit	Set me Kaçavida profesionale Frico	Cmimi
50097118	7	<ul style="list-style-type: none"> <li>⊖ 3,5 x 100</li> <li>⊖ 4,0 x 100</li> <li>⊖ 5,5 x 125</li> <li>⊖ 6,5 x 150</li> <li>⊕ PZ2 x 100</li> <li>⊕ PH1 x 80</li> <li>⊕ PH 2 x 100</li> </ul>	<b>3.590</b>

## Kaçavida profesionale Frico



felo  
Innovations



Kodi	Tipi	Permasa			Cmimi
55110240	Pozidriv	PZ1	90	5.0	<b>790</b>
55120340		PZ2	100	6.35	<b>850</b>
55130540		PZ3	155	8.0	<b>950</b>



felo  
Innovations



## Kaçavida profesionale HEX 1/4"



felo  
Innovations



Kodi	Gjatesia	Cmimi
53812540	100mm	<b>990</b>

## Kaçavida profesionale FRICO me kokë HEX 1/4" me adaptor

Kodi	Tipi	Kapja		Cmimi
53810040	538	1/4"	100	<b>1.500</b>

## Kaçavida profesionale Ergonic



felo  
Innovations



Kodi	Tipi	Permasa			Cmimi
	E sheshte	5.5 x 1,0	100	6.00	<b>590</b>
45005540		7.0 x 1,2	130	6.00	<b>690</b>
45010040		10 x 1,6	180	8.00	<b>890</b>
45012040		12 x 2.0	210	10	<b>990</b>

## Kaçavida profesionale Ergonic



felo  
Innovations



Kodi	Tipi	Permasa			Cmimi
	Philips	PH1	80		<b>490</b>
45210240		PH2	100		<b>590</b>
45230540		PH3	150		<b>690</b>

## Kaçavida mekanike profesionale



Kodi	Tipi	Permasa			Cmimi
	200				
20005490	E sheshte	5,0 x 0,8	125	5.00	<b>290</b>

Kodi	Tipi	Permasa			Cmimi
	201				
20120390	Pozidriv	PZ2	100	6.00	<b>590</b>



Kodi	Tipi	Permasa			Cmimi
	202				
20220390	Philips	PH2	100	6.00	<b>590</b>

Kodi	Tipi	Permasa			Cmimi
	208				
20808390	TORX	T8	60	3.00	<b>390</b>
20810390		T10	100	3.50	<b>450</b>
20825390		T25	100	5.00	<b>490</b>
20840490		T40	125	8.00	<b>590</b>



**made in Germany**  
since 1878

## Kaçavidë Profi Super VDE - Seria 513



Kodi	Tipi	Permasa			Cmimi
	513				
51303590	Slot	3.5 x 0,6	100	4.00	<b>650</b>
51304090		4.0 x 0.8	100	5.00	<b>750</b>
51304590		4,5 x 1,0	125	5.00	<b>790</b>

Kodi	Tipi	Permasa			Cmimi
	515				
51520390	Pozidriv	PZ2	200	6.0	<b>950</b>

## Kacavide me koke te kembeshme + 10 maja, doreze me 2 komponente



**1000 V**  
IEC 60900:2018



Kodi	Sasia setit	Kacavide me koke te kembeshme	Cmimi
02091206	10	<ul style="list-style-type: none"> <li>● Seria 518, 1/4"</li> <li>● 3.0 x 0.5</li> <li>● 4.0 x 0.8</li> <li>● 5.5 x 1.0</li> <li>● 7.0 x 1.2</li> <li>● PZ1 x 50</li> <li>● PZ2 x 50</li> <li>● PH0 x 50</li> <li>● PH1 x 50</li> <li>● PH2 x 50</li> <li>● Torx 20 x 50</li> <li>● Torx 15 x 50</li> </ul>	<b>1.990</b>



**made in Germany**  
since 1878



### Set kriketi me doreze mini 1/4" + 11 koka kriketi

Kodi	Sasia setit	Set kriketi me doreze mini 1/4"	Cmimi
05771106	11	Doreze kriketi Zgjatues 125 mm Zgjatues 50 mm Zgjatues 25 mm 5.5 mm, 6 mm 7 mm, 8 mm, 10 mm 11 mm, 13 mm	<b>2.900</b>

## MAJA INDUSTRIALE



### Maja 10 cope blister



Kodi	Tipi	Permasa	Modeli	Kapja	Cmimi
02101016	PZ1	25 mm	C 6.3	1/4"	<b>90</b>
02102016	PZ2	25 mm	C 6.3	1/4"	<b>90</b>

### Maja 10 cope blister



Kodi	Tipi	Permasa	Modeli	Kapja	Cmimi
02201016	PH1	25 mm	C 6.3	1/4"	<b>90</b>
02202016	PH2	25 mm	C 6.3	1/4"	<b>90</b>

### Maja Torx 10 cope blister



Kodi	Tipi	Permasa	Modeli	Kapja	Cmimi
02625016	T25	25 mm	C 6.3	1/4"	<b>150</b>
02627010	T27	25 mm	C 6.3	1/4"	<b>150</b>

### Maja Torx 10 cope blister



Kodi	Tipi	Permasa	Modeli	Kapja	Cmimi
02630016	T30	25 mm	C 6.3	1/4"	<b>150</b>
02640016	T40	25 mm	C 6.3	1/4"	<b>150</b>

### Maja me goditje 100 cope blister



Kodi	Tipi	Permasa	Modeli	Kapja	Cmimi
02202017	PH2	25 mm	C 6.3	1/4"	<b>70</b>

### Maja me goditje 100 cope blister



Kodi	Tipi	Permasa	Modeli	Kapja	Cmimi
02102117	PZ2	25 mm	C 6.3	1/4"	<b>70</b>

## Maja me goditje



Kodi	Tipi	Permasa	Modeli	Kapja	Cmimi
02202040	PH2	25 mm	C 6.3	1/4"	<b>250</b>
03102540	PZ2	50 mm	C 6.3	1/4"	<b>450</b>

## Maja me diamant



Kodi	Tipi	Permasa	Modeli	Kapja	Cmimi
02102080	PZ2	25 mm	C 6.3	1/4"	<b>450</b>
02202080	PH2	25 mm	C 6.3	1/4"	<b>450</b>



### Adaptor Magnetik 1/4"

Kodi	Gjatesia	Cmimi
03810390	58 mm	<b>450</b>



### Adaptor Magnetik per maja me goditje Impakt

Kodi	Gjatesia	Cmimi
03829594	59 mm	<b>1.990</b>



### Adaptor me koke fiksimi mekanike dhe rregullim thellesie

Kodi	Gjatesia	Cmimi
05910390	79 mm	<b>1.250</b>



Kodi	Sasia setit	Set adaptor + 10maja	Cmimi
02099506	10	<ul style="list-style-type: none"> <li>⊖ 0,8 x 5,0 / 1,0 x 5,5 / 1,2 x 7,0</li> <li>⊕ PZ 1 / PZ 2 / PZ 3</li> <li>⊖ PH 1 / PH 2 / PH 3</li> </ul>	<b>990</b>

## Maja me goditje 5 cope blister

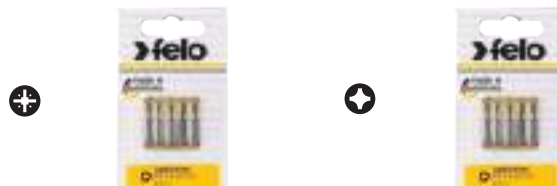

Kodi	Tipi	Permasa	Modeli	Kapja	Cmimi
02202056	PH2	25 mm	C 6.3	1/4"	<b>150</b>

## Maja TORSION



Kodi	Tipi	Permasa	Modeli	Kapja	Cmimi
02620000	T20	25 mm	C 6.3	1/4"	<b>180</b>



Kodi	Sasia setit	Set adaptor + 7 maja TORSION	Cmimi
02060306	7	<ul style="list-style-type: none"> <li>⊖ 0,8 x 5,5 / 1,0 x 6,5</li> <li>⊕ PZ 1 / PZ 2</li> <li>⊖ PH 1 / PH 2</li> </ul>	<b>950</b>
02060406	7	<ul style="list-style-type: none"> <li>⊖ 0,8 x 5,0 / 1,0 x 5,5 / 1,2 x 7,0</li> <li>⊕ PZ 1 / PZ 2 / PZ 3</li> <li>⊖ PH 1 / PH 2 / PH 3</li> </ul>	<b>950</b>



Kodi	Sasia setit	Set adaptor + 7 maja Titan	Cmimi
02060176	7	<ul style="list-style-type: none"> <li>⊖ 0,8 x 5,0 / 1,0 x 5,5 / 1,2 x 7,0</li> <li>⊕ PZ 1 / PZ 2 / PZ 3</li> <li>⊖ PH 1 / PH 2 / PH 3</li> </ul>	<b>990</b>

### Komplet Kriketi 192 cope



Seti permban: koka kriketi  
1/4+3/8+1/2" hex 4-32 mm me 6 faqe

Kodi	1150
Çmimi	<b>23.900</b>

### Komplet Kriketi 171 cope



Seti permban: koka kriketi  
1/4+3/8+1/2" hex 4-32 mm me 6 faqe

Kodi	1171
Çmimi	<b>17.900</b>

### Komplet me Pipo Trox + Pipo E



1/2 - 19 cope



Seti permban: Pipo Trox + Pipo E  
1/2", E10-24, T20-70 / TX-STAR

Kodi	1008/1
Çmimi	<b>5.990</b>

### Komplet me Pipo Torx te gjata



T70-100 4 cope



Seti permban: Pipo Trox 1/2" te gjata  
T70-100

Kodi	5004
Çmimi	<b>3.990</b>

### Komplet me Shlica 40 cope



Seti permban:maja trox, exagon dhe  
shlic te shkurtra dhe te gjata me kapje 3/8" 1/2"

Kodi	210/4
Çmimi	<b>4.590</b>

### Set me koka me 5 kende me vrime



1/4" / TS10-50



Seti permban: 9 koka me 5 kende  
me vrime

Kodi	1108
Çmimi	<b>2.190</b>

### Set me 10 koka kriketi ajri 1/2"



Seti permban: koka kriketi ajri  
1/2", 10 cope

Kodi	4778
Çmimi	<b>7.900</b>

### Komplet me koka kriketi te gjata



1/2" - 10 cope



Seti permban: koka kriketi ajri te  
gjata 1/2", 13-24 mm me 6 faqe

Kodi	1010/12T
Çmimi	<b>5.500</b>

### Komplet koka Kriketi me ajer



3/4" te shkurtra  
8 cope



Seti permban: koka kriketi 3/4" te  
shkurtra 22-38 mm me 6 faqe

Kodi	1010/34
Çmimi	<b>9.900</b>



### Set me koka kriketi te gjata



9 cope



Seti permban: Koka kriketi te gjata 3/8", 5/16-13/16"

Kodi	21612
Çmimi	<b>2.990</b>

### Set me koka kriketi



12 cope



Seti permban: Koka kriketi te gjata 1/4" + 3/8", E4-20

Kodi	1006
Çmimi	<b>1.790</b>

### Çeles dinamometrike 1/2"



Kodi	Kapja	Çmimi
96/2	1/2"	<b>4.900</b>

### Doreze Kriketi me kend e kromuar



Pershkrimi: doreze kriketi me 72 dhembe me doreze ergonomike

Kodi	Kapja	Çmimi
1205/1	1/4"	<b>2.190</b>
1205/2	3/8"	<b>2.590</b>
1205/3	1/2"	<b>3.490</b>

### Doreze Kriketi me kend e zeze



Pershkrimi: doreze kriketi me 72 dhembe me doreze ergonomike

Kodi	Kapja	Çmimi
1206/1	1/4"	<b>2.190</b>
1206/2	3/8"	<b>2.390</b>
1206/3	1/2"	<b>2.990</b>

### Doreze Kriketi me buton Profi



Pershkrimi: doreze kriketi me 72 dhembe me buton

Kodi	Kapja	Çmimi
1218/2	3/8"	<b>2.890</b>
1218/3	1/2"	<b>3.990</b>

### Doreze Kriketi me bisht teleskopik



Pershkrimi: doreze kriketi me 72 dhembe me bisht teleskopik

Kodi	Kapja	Çmimi
1208/1	1/4"	<b>2.990</b>

### Kaçavide 1/4 doreze ergonomike



Pershkrimi: kaçavide per koka 1/4" me 2 komponente 150 mm

Kodi	Kapja	Çmimi
21116	1/4"	<b>690</b>

### Leve Kriketi T + koke per leve Kriketi



Pershkrimi: T-Bar / T-Head

Kodi	Kapja	Çmimi
21120	1/4"	<b>390</b>
21520	3/8"	<b>890</b>
21920	1/2"	<b>1.190</b>
22720	koke 1"	<b>3.190</b>

### Zgjatues per koka Kriketi

1/4" 3/8" 1/2"



Kodi	Kapja + Gjatesi	Çmimi
21103	1/4"-75 mm	<b>290</b>
21105	1/4"-100 mm	<b>300</b>
21107	1/4"-300 mm	<b>800</b>

3/8" 1/2"



Kodi	Kapja + Gjatesi	Çmimi
21500	3/8" 75 mm	<b>350</b>
21503	3/8" 125 mm	<b>450</b>
21900	1/2" 125 mm	<b>590</b>
21905	1/2" 250 mm	<b>890</b>

3/4" 1"

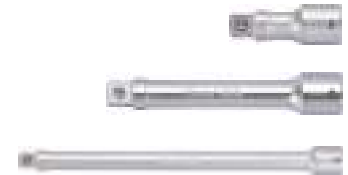

Kodi	Kapja + Gjatesi	Çmimi
22500	3/4" 100 mm	<b>1.690</b>
22505	3/4" 200 mm	<b>1.990</b>
22510	3/4" 400 mm	<b>2.990</b>

### Zgjatues per koka kriketi



Kodi	Kapja + Gjatesi	Çmimi
20125	1/2" -125 mm	<b>750</b>
20250	1/2" -250 mm	<b>990</b>

### Pipo kandelesh 3/8"



Kodi	Kapja	Çmimi
247/90	90 mm	<b>1.390</b>

### Adaptor ajri me koke te levizshme



Kodi	Kapja	Çmimi
21930	1/1"F 1/2"M	<b>1.890</b>

### Koke speciale e care



Kodi	Permase	Çmimi
4769-01	17 mm	<b>1.290</b>
4769-02	19 mm	<b>1.290</b>

### Koke kriketi speciale 1/2"



Kodi	Permase	Çmimi
4783	85 mm	<b>1.150</b>

### Celes gomash i zgjatueshem 50 mm



Kodi	Permase	Çmimi
48303	17/19 mm	<b>1.290</b>

### Adaptor Ajri

3/4" 1"



Kodi	Kapja	Çmimi
20610	3/4"F 1/2"M	<b>1.490</b>
20612	1"F x 3/4"M	<b>2.290</b>

### Adaptor Ajri

3/4"



Kodi	Kapja	Çmimi
20611	3/4"F x 1"M	<b>1.590</b>

### Set me 6 Adaptorre ajri

1/4"



Kodi	Kapja	Çmimi
206/6KR	1/4" 3/4"	<b>4.500</b>

### Koke kriketi me kend per maja 1/4" 1/2"



Kodi	Çmimi
21926	<b>1.590</b>

### Adaptor 1/2" x 3/8"



Kodi	Çmimi
20603	<b>320</b>

### Adaptor CR-MO 1/2F"x3/8M



Kodi	Çmimi
20603K	<b>990</b>

### Kryq Kriketi



Kodi	Kapja	Çmimi
21125	1/4"	<b>450</b>
21525	3/8"	<b>690</b>
21925	1/2"	<b>890</b>

### Set Adaptor magnetik per koka Kriketi



Seti permban:  
3 cope

Kodi	Kapja	Çmimi
20703	1/4" 3/8" 1/2"	<b>1.690</b>

### Set me 6 Adaptors



Seti permban:  
6 cope

Kodi	Kapja	Çmimi
206/6	1/4" 3/4"	<b>2.250</b>

### Adaptor per maja 1/4"



Kodi	Kapja	Çmimi
20624	1/4"Hex	<b>195</b>

### Adaptor per maja 1/4"



Kodi	Permasa	Çmimi
21260	60 mm	<b>195</b>

### Pipo speciale Shlic M17X55 mm



Kodi	Permasa	Çmimi
4779	60 mm	<b>1.350</b>

### Pipo Torx 1/2" e gjate



Kodi	Kapja	Çmimi
12203/40	T40x200	<b>990</b>
12143/45	T45x140	<b>850</b>
12203/45	T45x200	<b>990</b>

### Çeles per motorrino



Kodi	Permasa	Çmimi
4510	M10 x110 mm	<b>1.690</b>
4550	T50 x 110 mm	<b>1.690</b>

### Pipo Shlic+Adaptor per heqje Motorrino



Kodi	Permasa	Çmimi
4511	M10x 65 mm	<b>1.790</b>



**Maje shlice 10 mm**



Kodi	Kapja	Çmimi
18011/6	M6x30 mm	<b>170</b>
18011/8	M8x30 mm	<b>170</b>
18011/10	M10x30 mm	<b>170</b>
18011/12	M12x30 mm	<b>290</b>

**Maje shlice 10 mm**



Kodi	Kapja	Çmimi
18033/30	T30x30 mm	<b>170</b>
18033/40	T40x30 mm	<b>170</b>
18033/45	T45x30 mm	<b>170</b>

**Maje shlice 10 mm**



Kodi	Kapja	Çmimi
18071/6	M6x75 mm	<b>290</b>
18071/8	M8x75 mm	<b>290</b>
18071/12	M12x12 mm	<b>390</b>

**Maje Torx me vrime 8 mm**



Kodi	Kapja	Çmimi
17044/40	T40x30	<b>150</b>

**Pipo Shlic 1/2" CRV**



Kodi	Kapja	Çmimi
2357	M16x55	<b>690</b>

**Pipo shlice ajri 1/2"**



Kodi	Kapja	Çmimi
12071/K8	8M	<b>1.100</b>
12075/K9	9M	<b>1.150</b>
12071/K10	10M	<b>1.190</b>

**Pipo shlice ajri 1/2"**



Kodi	Kapja	Çmimi
12071/K14	14M	<b>1.290</b>
12071/K16	16M	<b>1.350</b>
12071/K18	18M	<b>1.500</b>

**Pipo Torx Ajri 1/2"**



Kodi	Kapja	Çmimi
12073/K20	20T	<b>1.350</b>
12073/K25	25T	<b>1.350</b>
12073/K27	27T	<b>1.350</b>
12073/K30	30T	<b>1.350</b>
12073/K40	40T	<b>1.350</b>



Kodi	Kapja	Çmimi
12073/K45	45T	<b>1.350</b>
12073/K50	50T	<b>1.350</b>
12073/K55	55T	<b>1.350</b>
12073/K60	60T	<b>1.350</b>
12073/K70	70T	<b>1.490</b>

**Koke Kriketi Ajri me 6 faqe 1/2"**



1/2" standart		
22000/K10	10 mm	<b>490</b>
22000/K12	12 mm	<b>490</b>
22000/K13	13 mm	<b>520</b>
22000/K14	14 mm	<b>520</b>
22000/K15	15 mm	<b>590</b>

**Koke Kriketi Ajri me 6 faqe 1/2"**



1/2" standart		
22000/K17	17 mm	<b>690</b>
22000/K19	19 mm	<b>690</b>
22000/K21	21 mm	<b>690</b>
22000/K22	22 mm	<b>690</b>
22000/K24	24 mm	<b>750</b>

**Koke Kriketi Ajri me 6 faqe 1/2"**



1/2" e gjate		
22099/K13	13 mm	<b>750</b>
22099/K14	14 mm	<b>750</b>
22099/K15	15 mm	<b>850</b>
22099/K16	16 mm	<b>850</b>
22099/K17	17 mm	<b>950</b>

**Koke Kriketi Ajri me 6 faqe 1/2"**



**1/2" e gjate**

22099/K18	18 mm	<b>950</b>
22099/K19	19 mm	<b>950</b>
22099/K21	21 mm	<b>950</b>
22099/K22	22 mm	<b>1.100</b>
22099/K24	24 mm	<b>1.350</b>

**Koke Kriketi Ajri me 6 faqe 3/4"**



**3/4" standart**

22600/K22	22 mm	<b>1.390</b>
22600/K24	24 mm	<b>1.390</b>
22600/K27	27 mm	<b>1.490</b>
22600/K28	28 mm	<b>1.550</b>

**Koke Kriketi Ajri me 6 faqe 3/4"**



**3/4" standart**

22600/K30	30 mm	<b>1.690</b>
22600/K32	32 mm	<b>1.800</b>
22600/K36	36 mm	<b>1.990</b>
22600/K38	38 mm	<b>2.090</b>

**Koke Kriketi Ajri me 6 faqe 3/4"**



**3/4" e gjate**

22699/K22	22 mm	<b>2.490</b>
22699/K24	24 mm	<b>2.490</b>
22699/K27	27 mm	<b>2.490</b>
22699/K28	28 mm	<b>2.490</b>

**Koke Kriketi Ajri me 6 faqe 3/4"**



**3/4" e gjate**

22699/K30	30 mm	<b>2.590</b>
22699/K32	32 mm	<b>1.990</b>
22699/K33	33 mm	<b>2.890</b>
22699/K36	36 mm	<b>3.490</b>
22699/K38	38 mm	<b>3.590</b>

**Koke Kriketi ajeri me Shlica**



**1/2" e gjate**

4803/33	33 mm	<b>1.990</b>
4803/34	34 mm	<b>1.990</b>
4803/36	36 mm	<b>2.490</b>

**Pipo Torx 1/4"**



**1/4" 37 mm gjatesia**

14033/7	T7	<b>220</b>
14033/8	T8	<b>220</b>
14033/9	T9	<b>220</b>
14033/10	T10	<b>220</b>

**Pipo Torx 1/4"**



**1/4" 37 mm gjatesia**

14033/15	T15	<b>220</b>
14033/20	T20	<b>220</b>
14033/25	T25	<b>220</b>
14033/27	T27	<b>220</b>

**Pipo Torx 1/4"**



**1/4" 37 mm gjatesia**

14033/30	T30	<b>220</b>
14033/40	T40	<b>220</b>
14033/45	T45	<b>270</b>

**Pipo Torx 1/2"**



**1/2" 55 mm gjatesia**

12033/20	T20	<b>490</b>
12033/25	T25	<b>490</b>
12033/27	T27	<b>490</b>
12033/30	T30	<b>490</b>
12033/40	T40	<b>490</b>

**Pipo Torx 1/2"**



**1/2" 55 mm gjatesia**

12033/45	T45	<b>490</b>
12033/50	T50	<b>490</b>
12033/55	T55	<b>550</b>
12033/60	T60	<b>550</b>
12033/70	T70	<b>650</b>

**Pipo Torx i gjate 1/2"**



**1/2" 100 mm gjatesia**

12103/20	T20	<b>590</b>
12103/25	T25	<b>550</b>
12103/27	T27	<b>590</b>
12103/30	T30	<b>550</b>
12103/40	T40	<b>560</b>

### Pipo Torx i gjate 1/2"



1/2" 100 mm gjatesia

12103/45	T45	<b>550</b>
12103/50	T50	<b>550</b>
12103/55	T55	<b>590</b>
12103/60	T60	<b>690</b>
12103/70	T70	<b>1.050</b>

### Pipo Hexagon i gjate 1/2"



1/2" 100 mm gjatesia

12102/5	5 mm	<b>550</b>
12102/6	6 mm	<b>550</b>
12102/7	7 mm	<b>590</b>
12102/8	8 mm	<b>590</b>

### Pipo Hexagon i gjate 1/2"



1/2" 100 mm gjatesia

12102/10	10 mm	<b>590</b>
12102/11	11 mm	<b>600</b>
12102/12	12 mm	<b>550</b>
12102/13	13 mm	<b>950</b>

### Pipo Hexagon 1/4"



1/4" 37 mm gjatesia

14022/3	3 mm	<b>210</b>
14022/4	4 mm	<b>210</b>
14022/5	5 mm	<b>210</b>
14022/6	6 mm	<b>210</b>
14022/7	7 mm	<b>210</b>
14022/8	8 mm	<b>210</b>

### Pipo Hexagon 1/2"



1/2" 55 mm gjatesia

12022/4	4 mm	<b>490</b>
12022/5	5 mm	<b>500</b>
12022/6	6 mm	<b>500</b>
12022/7	7 mm	<b>500</b>
12022/8	8 mm	<b>500</b>
12022/10	10 mm	<b>520</b>
12022/12	12 mm	<b>530</b>

### Pipo Hexagon 1/2"



1/2" 55 mm gjatesia

12022/14	14 mm	<b>590</b>
12022/17	17 mm	<b>690</b>
12022/18	18 mm	<b>990</b>
12022/19	19 mm	<b>990</b>
12022/22	22 mm	<b>1.100</b>
12022/24	24 mm	<b>1.500</b>

### Pipo Shlice 1/2"



1/2" 55 mm gjatesia

12011/5	M5 mm	<b>550</b>
12011/6	M6 mm	<b>550</b>
12011/8	M8 mm	<b>550</b>
12011/9	M9 mm	<b>550</b>

### Pipo Shlice 1/2"



1/2" 55 mm gjatesia

12011/10	M10 mm	<b>550</b>
12011/12	M12 mm	<b>590</b>
12011/14	M14 mm	<b>690</b>
12011/16	M16 mm	<b>690</b>

### Pipo Shlice e gjate 1/2"



1/2" 100 mm gjatesia

12101/5	M5 mm	<b>590</b>
12101/6	M6 mm	<b>590</b>
12101/8	M8 mm	<b>590</b>
12101/9	M9 mm	<b>590</b>

### Pipo Shlice e gjate 1/2"



1/2" 100 mm gjatesia

12101/10	M10 mm	<b>550</b>
12101/12	M12 mm	<b>690</b>
12101/14	M14 mm	<b>750</b>
12101/16	M16 mm	<b>1.300</b>

### Pipo Shlice e gjate 1/2"



1/2" 140 mm gjatesia

12141/8	M8 mm	<b>800</b>
12141/10	M10 mm	<b>850</b>
12141/12	M12 mm	<b>850</b>

### Pipo Shlice e gjate 1/2"



1/2" 200 mm gjatesia

12201/8	M8 mm	<b>1.950</b>
---------	-------	--------------



**Koke kriketi 1/4" me 6 faqe**



**1/4"standart**

21288/6	6 mm	<b>170</b>
21288/7	7 mm	<b>170</b>
21288/8	8 mm	<b>170</b>
21288/9	9 mm	<b>175</b>

**Koke kriketi 1/4" me 6 faqe**



**1/4"standart**

21288/10	10 mm	<b>175</b>
21288/11	11 mm	<b>175</b>
21288/12	12 mm	<b>175</b>
21288/13	13 mm	<b>195</b>
21288/14	14 mm	<b>199</b>

**Koke kriketi e gjate 1/4" me 6 faqe**



**1/4"e gjate**

21299/6	6 mm	<b>245</b>
21299/7	7 mm	<b>245</b>
21299/8	8 mm	<b>245</b>
21299/9	9 mm	<b>245</b>
21299/10	10 mm	<b>245</b>
21299/11	11 mm	<b>245</b>
21299/12	12 mm	<b>269</b>
21299/13	13 mm	<b>275</b>

**Koke kriketi 3/8" me 6 faqe**



**3/8"standart**

21688/6	6 mm	<b>185</b>
21688/7	7 mm	<b>185</b>
21688/8	8 mm	<b>185</b>
21688/9	9 mm	<b>185</b>
21688/10	10 mm	<b>185</b>
21688/11	11 mm	<b>199</b>

**Koke kriketi 3/8" me 6 faqe**



**3/8"standart**

21688/12	12 mm	<b>199</b>
21688/13	13 mm	<b>220</b>
21688/14	14 mm	<b>230</b>
21688/15	15 mm	<b>230</b>
21688/16	16 mm	<b>250</b>
21688/17	17 mm	<b>270</b>

**Koke kriketi 3/8" me 6 faqe**



**3/8"standart**

21688/18	18 mm	<b>290</b>
21688/19	19 mm	<b>320</b>
21688/20	20 mm	<b>320</b>
21688/21	21 mm	<b>350</b>
21688/22	22 mm	<b>350</b>
21688/24	24 mm	<b>390</b>

**Koke kriketi e gjate 3/8" me 6 faqe**



**3/8"e gjate**

21699/8	8 mm	<b>330</b>
21699/9	9 mm	<b>330</b>
21699/10	10 mm	<b>330</b>
21699/11	11 mm	<b>330</b>
21699/12	12 mm	<b>330</b>
21699/13	13 mm	<b>290</b>

**Koke kriketi e gjate 3/8" me 6 faqe**



**3/8"e gjate**

21699/14	14 mm	<b>350</b>
21699/15	15 mm	<b>390</b>
21699/16	16 mm	<b>450</b>
21699/17	17 mm	<b>450</b>
21699/18	18 mm	<b>490</b>
21699/19	19 mm	<b>490</b>

**Koke kriketi 1/2" me 6 faqe**



**1/2"standart**

22088/8	8 mm	<b>250</b>
22088/9	9 mm	<b>290</b>
22088/10	10 mm	<b>250</b>
22088/11	11 mm	<b>290</b>
22088/12	12 mm	<b>250</b>
22088/13	13 mm	<b>250</b>
22088/14	14 mm	<b>250</b>

**Koke kriketi 1/2" me 6 faqe**



**1/2"standart**

22088/15	15 mm	<b>250</b>
22088/16	16 mm	<b>260</b>
22088/17	17 mm	<b>270</b>
22088/18	18 mm	<b>250</b>
22088/19	19 mm	<b>290</b>
22088/20	20 mm	<b>350</b>
22088/21	21 mm	<b>350</b>

**Koke kriketi 1/2" me 6 faqe**



**1/2"standart**

22088/22	22 mm	<b>390</b>
22088/24	24 mm	<b>400</b>
22088/27	27 mm	<b>550</b>
22088/30	30 mm	<b>690</b>
22088/32	32 mm	<b>750</b>
22088/35	35 mm	<b>950</b>
22088/36	36 mm	<b>1.350</b>

**Koke kriketi e gjate 1/2"**



**1/2"e gjate**

22099/10	10 mm	<b>450</b>
22099/11	11 mm	<b>520</b>
22099/12	12 mm	<b>530</b>
22099/13	13 mm	<b>530</b>
22099/14	14 mm	<b>540</b>
22099/15	15 mm	<b>550</b>

**Koke kriketi e gjate 1/2"**



**1/2" e gjate**

22099/16	16 mm	<b>450</b>
22099/17	17 mm	<b>520</b>
22099/18	18 mm	<b>530</b>
22099/19	19 mm	<b>550</b>
22099/21	21 mm	<b>620</b>
22099/22	22 mm	<b>650</b>
22099/24	24 mm	<b>850</b>

**Koke kriketi 3/4" me 6 faqe**



**3/4" standart**

22600/19	19 mm	<b>850</b>
22600/21	21 mm	<b>850</b>
22600/22	22 mm	<b>850</b>
22600/23	23 mm	<b>850</b>
22600/24	24 mm	<b>850</b>
22600/26	26 mm	<b>900</b>

**Koke kriketi 3/4" me 6 faqe**



**3/4" standart**

22600/27	27 mm	<b>950</b>
22600/28	28 mm	<b>1.050</b>
22600/30	30 mm	<b>1.050</b>
22600/32	32 mm	<b>1.090</b>
22600/33	33 mm	<b>1.200</b>
22600/34	34 mm	<b>1.290</b>

**Koke kriketi 3/4" me 6 faqe**



**3/4" standart**

22600/36	36 mm	<b>1.300</b>
22600/41	41 mm	<b>1.700</b>
22600/46	46 mm	<b>2.200</b>
22600/50	50 mm	<b>2.350</b>

**Koke kriketi 1/2" me 12 faqe**



**1/2" standart**

22044/8	8 mm	<b>250</b>
22044/9	9 mm	<b>250</b>
22044/10	10 mm	<b>250</b>
22044/11	11 mm	<b>290</b>
22044/12	12 mm	<b>290</b>

**Koke Kriketi me 12 faqe 1/2"**



**1/2" standart**

22044/13	13 mm	<b>300</b>
22044/14	14 mm	<b>300</b>
22044/15	15 mm	<b>300</b>
22044/16	16 mm	<b>350</b>
22044/17	17 mm	<b>350</b>
22044/18	18 mm	<b>360</b>
22044/19	19 mm	<b>360</b>
22044/20	20 mm	<b>390</b>

**Koke Kriketi me 12 faqe 1/2"**



**1/2" standart**

22044/21	21 mm	<b>320</b>
22044/22	22 mm	<b>420</b>
22044/24	24 mm	<b>390</b>
22044/27	27 mm	<b>599</b>
22044/30	30 mm	<b>650</b>
22044/32	32 mm	<b>690</b>
22044/36	36 mm	<b>1.290</b>

**Koke Kriketi me shlica 12 faqe 3/4"**



**3/4" standart**

22644/19	19 mm	<b>850</b>
22644/21	21 mm	<b>850</b>
22644/22	22 mm	<b>890</b>
22644/23	23 mm	<b>890</b>
22644/24	24 mm	<b>890</b>
22644/26	26 mm	<b>950</b>
22644/27	27 mm	<b>950</b>
22644/28	28 mm	<b>1.050</b>

**Koke Kriketi me shlica 12 faqe 3/4"**



**3/4" standart**

22644/30	30 mm	<b>1.050</b>
22644/32	32 mm	<b>1.150</b>
22644/34	34 mm	<b>1.290</b>
22644/36	36 mm	<b>1.290</b>
22644/38	38 mm	<b>1.690</b>
22644/41	41 mm	<b>1.690</b>
22644/46	46 mm	<b>2.090</b>
22644/50	50 mm	<b>2.290</b>

**Pipo E 1/4"**



**1/4", standart**

22400/E4	E4	<b>250</b>
22400/E5	E5	<b>250</b>
22400/E6	E6	<b>250</b>
22400/E7	E7	<b>250</b>
22400/E8	E8	<b>250</b>
22400/E10	E10	<b>250</b>
22400/E11	E11	<b>250</b>

**Pipo E 1/2"**



**1/2", standart**

22440/E10	E10	<b>350</b>
22440/E11	E11	<b>350</b>
22440/E12	E12	<b>350</b>
22440/E14	E14	<b>350</b>
22440/E16	E16	<b>350</b>
22440/E18	E18	<b>390</b>
22440/E20	E20	<b>430</b>
22440/E22	E22	<b>450</b>
22440/E24	E24	<b>490</b>

**Pipo E e gjate 1/2"**



**1/2", e gjate**

22460/E10	E10	<b>750</b>
22460/E11	E11	<b>850</b>
22460/E12	E12	<b>790</b>
22460/E14	E14	<b>790</b>
22460/E16	E16	<b>850</b>
22460/E18	E18	<b>950</b>

**Komplet Hexagon me kend i shkurtër 9 cope**



Kodi	Permase	Çmimi
1121/3	1.5-10 mm	<b>1.900</b>

**Komplet Torx i Shkurtër 9 cope**



Kodi	Permase	Çmimi
1121/4	T10-50	<b>1.900</b>

**Komplet Torx I Gjate me vrimë i temperuar**



Kodi	Permase	Çmimi
1121/5	T10-50	<b>2.990</b>

**Komplet hexagon I gjate 9 cope**



Kodi	Sasia	Çmimi
1121Z	9 cope	<b>1.790</b>

**Çeles Gomash 17-19 mm**



17/19 mm

Kodi	Permase	Çmimi
1105	370-500 mm	<b>1.790</b>

**Celes Anglez (15 ") (18 ")**



Kodi	Permase	Çmimi
237/18	460 mm	<b>5.500</b>

**Zmerilues i brendshem me 2 krahe**



Kodi	Permase	Çmimi
5320	18-63 mm	<b>1.500</b>

**Zmerilues i brendshem me 3 krahe**



Kodi	Permase	Çmimi
5321	32-90 mm	<b>2.200</b>
5322	51-178 mm	<b>5.390</b>

**Zmusuese per tub presioni dhe multistrat**



Kodi	Permase	Çmimi
1285	4-42 mm	<b>1.250</b>

**Komplet bashkues telash**



Kodi	Sasia	Çmimi
9195	50 cope	<b>1.190</b>

**Komplet me germa shasie 27 cope**



Kodi	Permase	Çmimi
50/6	6 mm	<b>3.500</b>
50/10	10 mm	<b>9.500</b>

**Komplet me numra shasie 9 cope**



Kodi	Permase	Çmimi
51/6	6 mm	<b>1.190</b>
51/10	10 mm	<b>3.390</b>



### Çelesa Fiso-Stel Profi mat



Kodi	masa	Çmimi
2136/6	6 mm	<b>200</b>
2136/7	7 mm	<b>220</b>
2136/8	8 mm	<b>230</b>
2136/9	9 mm	<b>250</b>
2136/12	12 mm	<b>300</b>

2136/14	14 mm	<b>350</b>
2136/16	16 mm	<b>410</b>
2136/17	17 mm	<b>450</b>
2136/18	18 mm	<b>490</b>
2136/19	19 mm	<b>499</b>
2136/20	20 mm	<b>550</b>
2136/21	21 mm	<b>590</b>

2136/23	23 mm	<b>650</b>
2136/25	25 mm	<b>850</b>
2136/26	26 mm	<b>990</b>
2136/27	27 mm	<b>1.190</b>
2136/28	28 mm	<b>1.350</b>
2136/30	30 mm	<b>1.750</b>
2136/32	32 mm	<b>1.790</b>

### Çelesa Fiso-Stel Chrome Vanadium



Kodi	masa	Çmimi
3525/6	6 mm	<b>125</b>
3525/7	7 mm	<b>125</b>
3525/8	8 mm	<b>145</b>
3525/9	9 mm	<b>160</b>
3525/10	10 mm	<b>170</b>
3525/11	11 mm	<b>170</b>
3525/12	12 mm	<b>180</b>
3525/13	13 mm	<b>220</b>
3525/14	14 mm	<b>250</b>
3525/15	15 mm	<b>270</b>
3525/16	16 mm	<b>270</b>
3525/17	17 mm	<b>290</b>

3525/18	18 mm	<b>320</b>
3525/19	19 mm	<b>350</b>
3525/20	20 mm	<b>390</b>
3525/21	21 mm	<b>399</b>
3525/22	22 mm	<b>500</b>
3525/23	23 mm	<b>700</b>
3525/24	24 mm	<b>790</b>
3525/25	25 mm	<b>790</b>
3525/26	26 mm	<b>790</b>
3525/27	27 mm	<b>990</b>
3525/28	28 mm	<b>1.350</b>
3525/30	30 mm	<b>1.450</b>
3525/32	32 mm	<b>1.590</b>

### Set me Çelesa Fiso-Stel



**CHROME  
VANADIUM**

25 cope

Kodi	Permasa	Çmimi
35/25T	6-32 mm	<b>5.500</b>

### Set Fiso-Stel 8 cope



8 cope

Kodi	Permasa	Çmimi
35/8T	6-19 mm	<b>1.250</b>

### Komplet me 8 celesa fiso-fiso



Kodi	Permasa	Çmimi
25/8T	6-22 mm	<b>1.990</b>

### Komplet me celesa fiso-fiso 12 cope



Kodi	Permasa	Çmimi
25/12T	6-32 mm	<b>4.290</b>

Set Fiso-Stel Chrome Vanadium



17 cope

Kodi	Permasa	Çmimi
35/17T	6-24 mm	<b>3.900</b>

Set Fiso-Stel Chrome Vanadium



12 cope

Kodi	Permasa	Çmimi
35/12T	6-22 mm	<b>1.990</b>

Set Fiso-Stel Profi mat 25 cope



25 cope

Kodi	Permasa	Çmimi
2135	6-32 mm	<b>9.900</b>

Set me Çelesa F-Stel te mat te shkurtër



10 cope

Kodi	Permasa	Çmimi
4410	10-19 mm	<b>3.990</b>

Set me Çelesa Poligon CrV



12 cope

Kodi	Permasa	Çmimi
10/12T	6-32 mm	<b>4.900</b>

Komplet me Çelesa te çare me kend



5cope

Kodi	Permasa	Çmimi
4079/5SA	8-12 mm	<b>6.500</b>

Set Fiso-Stel Kriket 8 cope



Kodi	masa	Çmimi
4100/15	15 mm	<b>1.450</b>
4100/16	16 mm	<b>1.590</b>
4100/18	18 mm	<b>1.950</b>
4100/24	24 mm	<b>3.200</b>

Komplet me Çeles tubolar te drejte



8 cope

Kodi	Permasa	Çmimi
125	6-22 mm	<b>2.500</b>

Komplet me Çeles S-Type mat



5 cope

Kodi	Permasa	Çmimi
4405	8-22 mm	<b>1.590</b>

Çelesa Poligon Chrome-Vanadium



Kodi	Kapja	Çmimi
1012/8x9	8x9 mm	<b>235</b>
1012/10x11	10x11 mm	<b>260</b>
1012/12x13	12x13 mm	<b>290</b>

Kodi	Permasa	Çmimi
1012/14x15	14x15 mm	<b>320</b>
1012/16x17	16x17 mm	<b>390</b>
1012/18x19	18x19 mm	<b>490</b>
1012/20x22	20x22 mm	<b>590</b>

Kodi	Permasa	Çmimi
1012/21x23	21x23 mm	<b>690</b>
1012/24x27	24x27 mm	<b>850</b>
1012/25x28	25x28 mm	<b>950</b>
1012/30x32	30x32 mm	<b>990</b>

### Kaçavide mekanike 450 mm



Kodi	Permasa	Çmimi
20450/6	6.5	<b>1.590</b>

### Kaçavide mekanike 450 mm



Kodi	Permasa	Çmimi
20450/2	Ph2	<b>1.590</b>

### Kaçavide fleksibel me kapje 1/4"



Kodi	Permasa	Çmimi
921	320 mm	<b>1.590</b>

### Set Kaçavida elektronike



- pete: 2.4x75 mm, 3.0x100 mm
- kryq: PH0x75 mm

Kodi	Çmimi
345	<b>390</b>

### Kaçavide per maja



Kodi	Kapja	Çmimi
21118	1/4" hex	<b>750</b>

### Komplet Kaçavide+maja 122 cope



Kodi	Permasa	Çmimi
2122	1/4"hex	<b>4.500</b>

### Komplet Kaçavidash me goditje



12 cope

Kodi	Permasa	Çmimi
912	12 cope	<b>5.500</b>

### Çelesa Taf Pipo



Kodi	Permasa	Çmimi
2020/6	6x230	<b>1.150</b>
2020/7	7x230	<b>1.190</b>
2020/9	9x230	<b>1.190</b>
2027/10	10x230	<b>1.390</b>

### Çelesa Taf Pipo



Kodi	Permasa	Çmimi
2020/11	11x230	<b>1.190</b>
2020/12	12x230	<b>1.150</b>
2027/13	13x230	<b>1.690</b>
2020/14	14x230	<b>1.750</b>

### Çelesa Taf Torx 360 mm te gjate



Kodi	Permasa	Çmimi
11183/10	T10	<b>1.790</b>
11183/20	T20	<b>1.790</b>
11183/25	T25	<b>1.790</b>
11183/30	T30	<b>1.790</b>



### Çeles Hidraulik i veshur



Kodi	Permase	Çmimi
272CV175	175 mm	<b>990</b>
272CV240	240 mm	<b>1.190</b>

### Komplet me pinca me qafe te gjate



3 cope	280 mm	
Kodi	275 mm	Çmimi
1183	260 mm	<b>4.390</b>

### Komplet me pinca preçizioni



4 cope		
Kodi	Permase	Çmimi
760	110-120 mm	<b>1.990</b>

### Pince per Rondele rrethore bronxi



Kodi	Permase	Çmimi
785	165 mm	<b>1.250</b>

### Komplet me rondele bronxi



400 cope		
Kodi	Permase	Çmimi
786	4.4 mm	<b>490</b>

### Pince Fermo me 4 koka te ndryshme



Kodi	Permase	Çmimi
279A	160 mm	<b>950</b>

### Gershere Ilamarine



Kodi	Permase	Çmimi
387	250 mm	<b>1.250</b>

### Pince per heqje fashetash 280 mm



Kodi	5730
Çmimi	<b>1.390</b>

### Pince per fashetat metalike



Kodi	Permase	Çmimi
4725	e drejte 210 mm	<b>2.900</b>
4725/1	me kend 220 mm	<b>2.990</b>

### Komplet me 22 maja shlice



Kodi	Kapja	Çmimi
210/5	3/8"+1/2"	<b>4.900</b>

### Komplet me 100 maja

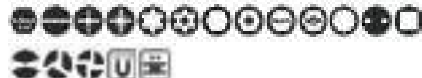

Kodi	Permase	Çmimi
1100	1/4"hex	<b>2.590</b>

### Komplet 55 majash te gjata



Kodi	Kapja	Çmimi
1101	1/4" hex	<b>4.900</b>

**Komplet filetimi metrik  
110 cope**



110 cope

Kodi	Permase	Çmimi
144	M2-M18	<b>25.900</b>

**Komplet filetimi metrik  
45 cope**



45 cope

Kodi	Permase	Çmimi
149	M6-M24	<b>16.900</b>

**Komplet filetimi metrik  
32 cope**



32 cope

Kodi	Permase	Çmimi
145	M3-M12	<b>6.900</b>

**Matravide filetimi**



Kodi	Permase	Çmimi
156/12	M12 x 1.75	<b>2.590</b>

**Krahe Matravide**



Kodi	Permase	Çmimi
158/1	20 x 5 mm	<b>1.090</b>
158/2	20 x 7 mm	<b>1.090</b>
158/3	25 x 9 mm	<b>1.150</b>
158/5	38 x 14 mm	<b>2.290</b>

**Komplet me 3 meshkuj filetimi**



Kodi	Permase	Çmimi
155/3	M3 X 0.5	<b>1.390</b>
155/4	M4 X 0.7	<b>1.390</b>
155/5	M5 X 0.8	<b>1.390</b>
155/6	M6 X 1.0	<b>1.390</b>
155/8	M8 x 1.25	<b>1.590</b>
155/12	M12 x 1.75	<b>2.690</b>

**Komplet me 3 meshkuj filetim**



Kodi	Permase	Çmimi
9660-06	M6x1.0	<b>1.100</b>
9660-08	M8x1.25	<b>1.500</b>
9660-10	M10x1.5	<b>1.700</b>

**Krahe per meshkuj filetimi**



Kodi	Permase	Çmimi
157/1	180 mm	<b>1.290</b>
157/1.5	180 mm	<b>1.690</b>
157/2	280 mm	<b>2.390</b>

**Krahe per (M) filetimi Kriket**



Kodi	Permase	Çmimi
159/1	85 mm	<b>1.350</b>
159/2	105 mm	<b>1.590</b>

**Set me Punto freze konike Titan**



Kodi	Permase	Çmimi
443	4-32 mm	<b>5.490</b>

**Punto freze Titan**



• HSS, titanium coated, minimum wear

Kodi	Permase	Çmimi
443/1	4-12 mm	<b>1.790</b>
443/2	4-20 mm	<b>1.990</b>
443/3	4-32 mm	<b>3.490</b>

**Set me mini kunja zmerilimi diamanti**



20 cope

Kodi	Permasa	Çmimi
447	45 mm	<b>700</b>

**Set per heqjen e permistopave**



Kodi	Seti	Çmimi
1582	3 cope	<b>2.900</b>

**Ekstrator per koka zbare**



Kodi	Permasa	Çmimi
183	20/50 mm	<b>3.290</b>

**Zinxhir filtri vaji 1/2"**



Kodi	Permasa	Çmimi
4246	60-115 mm	<b>4.900</b>

**Set me mini kunja zmerilimi diamanti**



50 cope

Kodi	Permasa	Çmimi
446	45 mm	<b>4.990</b>

**Set me 4 morseta per heqjen e fashetave**



4 cope

Kodi	Permasa	Çmimi
4754	10-45 mm	<b>2.900</b>

**Ekstrator me 2 dhe 3 krahe**



Kodi	Permasa	Çmimi
141/100	2-100 mm	<b>1.350</b>
141/150	2-150 mm	<b>1.990</b>
142/100	3-100 mm	<b>1.790</b>
142/150	3-150 mm	<b>2.890</b>

**Çeles profi me zinxhire per filter vaji**



Kodi	Permasa	Çmimi
4248	60-160 mm	<b>7.900</b>

**Set me 313 mini kunja zmerilimi**



313 cope

Kodi	Aksesore	Çmimi
445	313 cope	<b>4.990</b>

**Ekstrator per koka zbare me 2 krahe**



Kodi	Permasa	Çmimi
182	30 / 55 mm	<b>5.900</b>

**Komplet me 3 Ekstrator**



3 cope

Kodi	Permasa	Çmimi
4565	23 / 28 / 34	<b>14.500</b>

**Çeles fasho metalik per filtrat e vajit**



Kodi	Permasa	Çmimi
4244	65-105 mm	<b>1.190</b>
4245	110-155 mm	<b>1.190</b>



**Pompe per levizjen e vajit**



4 cope

Kodi	Çmimi
3989	<b>5.500</b>

**Kupe metalike per heqjen e filtrave te vajit**



Kodi	Permasa	Çmimi
4250/1	60-80 mm	<b>7.500</b>
4250/2	80-110 mm	<b>10.500</b>

**Çeles per filtrin e vajit me 3 krahe**



Kodi	Permasa	Çmimi
251	65-130 mm	<b>1.690</b>

**Kupe metalike per heqjen e filtrave te vajit**



Kodi	Permasa	Çmimi
38414	78 mm	<b>1.050</b>

**Kupe alumini per heqjen e filtrave te vajit**



Kodi	Kapja	Çmimi
353/74/14	1/2" / 27 mm	<b>1.500</b>

**Komplet me kupa metalike per filtra vaji**



9 cope

Kodi	Kapja	Çmimi
353/9	3/8"	<b>11.900</b>

**Set me leva plastike 5 cope**



5 cope

Kodi	Permasa	Çmimi
3708	160-210 mm	<b>2.900</b>

**Set me leva tapicerie plastike**



5 cope

Kodi	Permasa	Çmimi
3707	200-250 mm	<b>4.900</b>

**Set me leva tapicerie metalike**



5 cope

Kodi	Çmimi
3730	<b>4.590</b>

**Komplet llamarinisti 7 cope**



7 cope

Kodi	Çmimi
103	<b>7.500</b>

**Set me leva plastike 11 cope**



11 cope

Kodi	Permasa	Çmimi
3709	160-200 mm	<b>4.900</b>

**Set me dalta plastike 4 cope**



Kodi	Çmimi
3706	<b>2.990</b>

### Leve tapicerie metalike



Kodi	Kapja	Çmimi
3721	0-2 mm	<b>1.090</b>

### Leve tapicerie metalike



Kodi	Permasa	Çmimi
3724	235 mm	<b>1.090</b>

### Set me 2 leva tapicerie



Kodi	Çmimi
3720	<b>1.990</b>

### Indikator metalik makinash



Kodi	Permasa	Çmimi
585	110 mm	<b>450</b>

### Zhveshese kabli



Kodi	Permasa	Çmimi
3060/1	0.2 - 0.8 mm <sup>2</sup>	<b>2.690</b>
3060/2	0.8 - 2.6 mm <sup>2</sup>	<b>2.690</b>

### Pince per shtrengimin e terminaleve



Kodi	Permasa	Çmimi
3045	0.5 - 6 mm <sup>2</sup>	<b>3.490</b>

### Komplet per shtrengim dhe zhveshje teli



Kodi	Seti	Çmimi
3154	48 cope	<b>2.990</b>

### Set me mini pinceta 28 cope



28 cope		Çmimi
Kodi		<b>1.150</b>
9196		

### Set gominash 225 cope



225 cope		Çmimi
Kodi	Permasa	<b>950</b>
1580/225	3-22 mm	

### Set gominash 419 cope



419 cope		Çmimi
Kodi	Masa	<b>2.590</b>
1580/419	3-50 mm	

### Set me 265 gomina jeshile



265 cope		Çmimi
Kodi	Masa	<b>4.590</b>
9150	18 Madhesi	

### Set gominash per tub benzine



141 cope		Çmimi
Kodi		<b>1.390</b>
9180		

**Set me rondere bakri 150 cope**



150 cope

Kodi	Masa	Çmimi
9000	15 Madhesi	<b>3.900</b>

**Set me rondere bakri 390 cope**



390 cope

Kodi	Masa	Çmimi
9005	30 Madhesi	<b>7.900</b>

**Set me rondere alumini 450 cope**



450 cope

Kodi	Masa	Çmimi
9160	18 Madhesi	<b>2.900</b>

**Komplet koka grasatimi 110 cope**



110 cope

Kodi	Pershkrim	Çmimi
9030	Drejt, 45°, 90°	<b>2.900</b>

**Set me preçina me fileto 150 cope**



150 cope

Kodi	Materiali	Çmimi
9040	Alumini	<b>2.190</b>

**Komplet fermo me kapje nga brenda dhe nga jashte**



300 cope

Kodi	Permasa	Çmimi
9070	3 - 32 mm	<b>1.990</b>
9080	3 - 32 mm	<b>1.990</b>

**Set me 300 cope fermo te çara**



300 cope

Kodi	Permasa	Çmimi
9090	1.5 - 22 mm	<b>1.900</b>

**Set me kunjja te brendshme**



315 cope

Kodi	Permasa	Çmimi
9100	2 - 10 mm	<b>2.190</b>

**Komplet kunjash 555 cope**



555 cope

Kodi	Pershkrim	Çmimi
9110	Model i drejte	<b>1.250</b>

**Komplet kunjash R 150 cope**



150 cope

Kodi	Masa	Çmimi
9120	6 Madhesi	<b>1.050</b>

**Komplet me susta te ndryshme**



200 cope

Kodi		Çmimi
9130		<b>1.390</b>

**Komplet me gomina te sheshta**



125 cope

Kodi	Masa	Çmimi
9020	18 Madhesi	<b>1.750</b>



**Set me 100 fasheta metalike**



Kodi	Permase	Çmimi
9300/16	10-16 mm	<b>5.290</b>

**Kapikorda baterish 2 cope**



Kodi	Tensioni	Çmimi
3710	12-24 V	<b>590</b>

**Set Testimi per komprimimin e motorrit**



Kodi	Permase	Çmimi
3540	300 mm	<b>4.590</b>

**Çeles per fasho**



Kodi	Permase	Çmimi
180A	40-75 mm	<b>1.900</b>

**Çeles per fasho**



Kodi	Permase	Çmimi
180B	57-125 mm	<b>2.200</b>

**Çeles per fasho**



Kodi	Permase	Çmimi
180C	90-175 mm	<b>2.500</b>

**Komplet per hapjen e tubave te bakrit**



8 cope		
Kodi	Permase	Çmimi
410	3/8-1.1/4"	<b>4.500</b>

**Kthyses tubash për bakër/alumin**



Kodi	Permase	Çmimi
409	6-8-10 mm	<b>1.990</b>

**Leve gomash e drejte**



Kodi	Permase	Çmimi
265/400	400 mm	<b>1.090</b>
265/500	500 mm	<b>1.390</b>
265/600	600 mm	<b>1.990</b>

**Mbulese magnetike per parafrango**



Kodi	Permase	Çmimi
3801	79x59 cm	<b>1.590</b>

**Morsete per trapan bango**

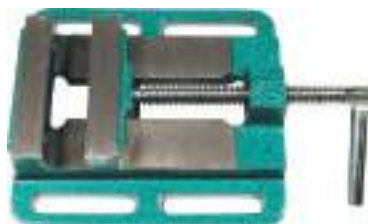

Kodi	Permase	Çmimi
74	100 mm	<b>3.990</b>

**Mandrino PROFIL me kend**



Kodi	Permase	Çmimi
8600	10 mm	<b>2.290</b>

### Hinke plastike



Kodi	Diametri	Çmimi
3703	140 mm	<b>450</b>

### Komplet me 4 hinka plastike



4 cope

Kodi	Diametri	Çmimi
3702	50,75,95,115mm	<b>350</b>

### Hinke plastike me kend



Kodi	Diametri	Çmimi
9975	145 mm	<b>490</b>

### Pompe dore per levizjen e lengjeve



Kodi	Gjatesia tubit	Çmimi
3990	2 m	<b>2.900</b>

### Kapes magnetik



Kodi	Permasa	Çmimi
427	600 mm	<b>290</b>

### Nxjerres magnetik teleskopik

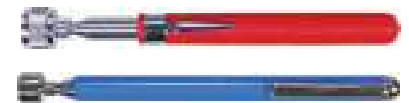

Kodi	Permasa	Çmimi
373	170-760 mm	<b>1.690</b>
373A	130-640 mm	<b>1.090</b>

### Nxjerres magnetik teleskopik



Kodi	Permasa	Çmimi
372	120-650 mm	<b>690</b>

### Nxjerres magnetik me bisht te perkulshem



Kodi	Permasa	Çmimi
374A	510 mm	<b>900</b>
374	550 mm	<b>1.350</b>

### Nxjerres dhe kapes magnetik



Kodi	Permasa	Çmimi
426	700 mm	<b>1.750</b>

### Mini pompe graso



Kodi	Kapaciteti	Çmimi
3982	110 g	<b>1.590</b>

### Tab fleksibel per pompa grasatimi



Kodi	Permasa	Çmimi
3980A	300 mm	<b>950</b>
3980B	500 mm	<b>1.090</b>
3980D	koke graso	<b>390</b>

### Kendore magnetike per saldime



Kodi	Permasa	Çmimi
429A	90°	<b>790</b>

Set me 6 lima



Kodi	Permasa	Çmimi
63	150 mm	<b>750</b>

Çeles kriket filtri vaji me veteshtrangim



Kodi	Permasa	Çmimi
89	95 mm	<b>650</b>

Mates kendesh force shtrenguese 1/2"



Kodi	98
Çmimi	<b>1.990</b>

Set me lule freza metali 6 cope HSS



Kodi	444
Çmimi	<b>2.690</b>

Set me 5 lule freza 90 mm



Kodi	Permasa	Çmimi
438	15-35 mm	<b>2.290</b>

Pince gomisti



Kodi	Permasa	Çmimi
294	24mm	<b>2.790</b>

Pompe vakumi 1.5 L



Kodi	Kapaciteti	Çmimi
3991	1500 cm <sup>3</sup>	<b>7.500</b>

Mandrino Quick



Kodi	Permasa	Çmimi
8520	1-16 mm B16	<b>7.500</b>

Komplet Kaçavide me goditje



6 cope		
Kodi	Permasa	Çmimi
222	8-10 mm	<b>2.390</b>

Matесе magnetike per kende 1/2"



Kodi	Kapja	Çmimi
99/1	1/2"	<b>3.500</b>

Specimeter me 20 flete 100 mm



Kodi	Permasa	Çmimi
172	0.05-1.00	<b>590</b>

Vizore inoxi 6" 12" 20" 40"



Kodi	Permasa	Çmimi
139/3	500 mm	<b>650</b>
139/4	1000 mm	<b>1.690</b>



### Komplet me shpatulla metali



4 cope

Kodi	Permase	Çmimi
390	50,80,100,120mm	<b>299</b>

### Komplet me shpatulla plastike



4 cope

Kodi	Permase	Çmimi
390A	50,75,100,120mm	<b>220</b>

### Shenues metali



Kodi	Çmimi
5930	<b>990</b>

### Pastrues universal



Kodi	Gjatesia	Çmimi
815	170 mm	<b>200</b>

### Brez lekure



Kodi	Permase	Çmimi
3955	550 mm	<b>1.790</b>

### Set me 3 lapustila



3 cope		
Kodi	Ngjyrat	Çmimi
699	blu,kuqe,zeze	<b>390</b>

### Lapsa karpentieri 12 cope



12 cope

Kodi	fuqia drites	Çmimi
644	125 lm	<b>420</b>

### Pasqyr mekaniku me bisht teleskopik



Kodi	Permase	Çmimi
3567	550 mm	<b>550</b>

### Komperator DIN 878



Kodi	Permase	Çmimi
1380	ø 60 mm	<b>4.590</b>
1381	ø 42 mm	<b>4.500</b>

### Mikrometer 1/100 mm



Kodi	Permase	Çmimi
1370/3	50-75 mm	<b>3.900</b>

### Stativ me magnet per komperator



Kodi	Permase	Çmimi
1388	e rregullueshme	<b>3.990</b>

### Shtrat mekaniku



Kodi	Permase	Çmimi
9200	1000 mm	<b>7.900</b>

## KOMPLET KRIKETI 1/4"



Kodi	Kapja	Çmimi
58160	1/4" 16 cope	<b>690</b>

## KOMPLET KRIKETI 1/4"



Kodi	Kapja	Çmimi
58640	1/4" 38 cope	<b>1.990</b>

## KOMPLET KRIKETI 1/4"



Kodi	Kapja	Çmimi
58641	1/4" 42 cope	<b>2.200</b>

## KOMPLET KRIKETI 1/4"



Kodi	Kapja	Çmimi
58643	1/4" 56 cope	<b>2.900</b>

## KOMPLET KRIKETI 1/2"



Kodi	Kapja	Çmimi
58687	1/2" 94 cope	<b>5.900</b>

## KOMPLET KRIKETI 1/2"+3/8"+1/4" 173 COPE



Kodi	Kapja	Çmimi
58688	1/2"+3/8"+1/4"	<b>9.900</b>

## KOMPLET KRIKETI 1/2"+3/8"+1/4" 216 COPE



Kodi	Kapja	Çmimi
58700	1/2"+3/8"+1/4"	<b>13.500</b>

## KOMPLET KRIKETI 1/2"+3/8"+1/4" 216 COPE



Kodi	Kapja	Çmimi
58691	1/2"+3/8"+1/4"	<b>14.900</b>

## SET ME 40 SHLICA



Kodi	Sasia	Çmimi
66400	40 shlica	<b>2.200</b>

## SET TAF ME MAJA DHE KOKA KRIKETI



Kodi	Sasia	Çmimi
65150	41 cope	<b>750</b>

## PISTOLETE GRASATIMI + TUB REZERVE



Kodi	Kapaciteti	Çmimi
78047	500 ml	<b>1.750</b>

## CELESH FASHO METALIK PER FILTRA VAJI 55-110MM



Kodi	Permasa	Çmimi
57610	55-110 mm	<b>690</b>

**KRYQ KRIKETI**

Kodi	Dimensioni	Çmimi
57000	17x19x22x13/16"	<b>850</b>

**LEVE KRIKETI ME KOKE TE LEVIZHME**

Kodi	Dimensioni	Çmimi
53710	3/4"x450 mm	<b>1.690</b>

**ZGJATUES KRIKETI 3/4"**

Kodi	Permasa	Çmimi
53650	100 mm	<b>650</b>
53670	200 mm	<b>890</b>

**CELES TUB L**

Kodi	Permasa	Çmimi
54600	6 mm	<b>99</b>
54610	7 mm	<b>190</b>
54630	9 mm	<b>125</b>
54660	12 mm	<b>150</b>
54720	18 mm	<b>290</b>

**KOKE KRIKETI UNIVERSALE**

Kodi	Permasa	Çmimi
53002	3/8" 7-19 mm	<b>790</b>

**KOKE KRIKETI ME 6 FAQE 3/4"**

Kodi	Dimensioni	Çmimi
53450	36 mm	<b>550</b>

**CELES TAF TORX**



Kodi	Madhesia	Çmimi
56630	T10	<b>179</b>
56631	T15	<b>189</b>
56632	T20	<b>190</b>

**CELES TAF TORX**

Kodi	Madhesia	Çmimi
56633	T25	<b>190</b>
56634	T27	<b>190</b>
56635	T30	<b>220</b>

**CELES TAF TORX**

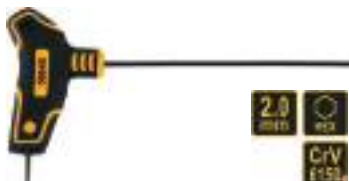
Kodi	Madhesia	Çmimi
56636	T40	<b>230</b>
56637	T45	<b>240</b>
56638	T50	<b>250</b>

**CELES TAF HEXAGON**

Kodi	Permasa	Çmimi
56640	2.0 mm	<b>125</b>
56641	2.5 mm	<b>125</b>
56642	3.0 mm	<b>135</b>
56645	6.0 mm	<b>199</b>

**CELES TAF HEXAGON**

Kodi	Permasa	Çmimi
56646	7.0 mm	<b>220</b>
56647	8.0 mm	<b>255</b>
56648	10.0 mm	<b>285</b>

**CELES HIDRAULIK SUEDEZ**

Kodi	Permasa	Çmimi
55220	1" 45°	<b>1.500</b>
55221	1.5" 45°	<b>1.790</b>
55222	2" 45°	<b>2.590</b>



## KALIBER INOXI 150 MM



Kodi	Permasa	Çmimi
15100	150 mm	<b>950</b>

## KALIBER PLASTIK 150 MM



Kodi	Permasa	Çmimi
15120	150 mm	<b>139</b>

## TESTER BATERIE



Kodi	Voltazhi	Çmimi
81741	12 V	<b>850</b>

## INDIKATOR MAKINE



Kodi	Voltazhi	Çmimi
65270	6-24 V 110 mm	<b>320</b>

## LLAMPE MEKANIKU



Kodi	Voltazhi	Çmimi
82699	3.2 W 280 Lm	<b>1.450</b>

## LLAMPE MEKANIKU



Kodi	Voltazhi	Çmimi
82713	100 W 5 m	<b>2.290</b>

## NDRICUES MEKANIKU 3 W LED 150 LM



Kodi	Dimensioni	Çmimi
82724	3 W	<b>850</b>

## NDRICUES MEKANIKU 5 W LED 300 LM



Kodi	Dimensioni	Çmimi
82736	5 W	<b>1.990</b>

## MORSETE BANGO MINI E RROTULLUESHME



Kodi	Madhesia	Çmimi
36014	40 mm	<b>990</b>
36015	50 mm	<b>950</b>
36016	60 mm	<b>950</b>

## SET ME PINCE TERMINALI ME AKSESORE 0.5-6MM



Kodi	Per dimensione	Çmimi
45050	0.5-6 mm	<b>850</b>

## PINCE ZHVESHESHE KABULLI AUTOMATIKE



Kodi	Dimensioni	Çmimi
45100	165 mm	<b>250</b>

## MORSETE BANGO MINI FIKSE



Kodi	Madhesia	Çmimi
36000	25 mm	<b>490</b>
36004	40 mm	<b>590</b>

**PINCE ZHVESHESE  
DHE PRERESE KABULLI  
AUTOMATIKE 165MM**

Kodi	Per dimensione	Çmimi
45201	0.5-4 mm	<b>420</b>

**GERSHERE LLAMARINE  
ME KEND 45-120 GRADE  
5 NE 1**

Kodi	Gjatesia	Çmimi
48350	220 mm	<b>1.990</b>

**QESE PRESIONI ME AJER  
PER HAPJE DYERSH**

Kodi	Permasa	Çmimi
39002	130x270 mm	<b>650</b>

**CELES FISO-STEL  
KRIKET**

Kodi	Permasa	Çmimi
52652	10 mm	<b>420</b>
52654	12 mm	<b>450</b>
52655	13 mm	<b>490</b>

**CELES FISO-STEL  
KRIKET**

Kodi	Permasa	Çmimi
52656	14 mm	<b>550</b>
52657	15 mm	<b>550</b>
52658	18 mm	<b>650</b>

**PINCE FERMO PER  
HAPJE E DREJTE**

Kodi	Dimensioni	Çmimi
43050	160 mm	<b>390</b>

**PINCE FERMO PER  
HAPJE E KTHYER**

Kodi	Dimensioni	Çmimi
43051	160 mm	<b>390</b>

**PINCE FERMO PER  
MBYLLJE E DREJTE**

Kodi	Dimensioni	Çmimi
43052	160 mm	<b>390</b>

**PINCE FERMO PER  
MBYLLJE E KTHYER**

Kodi	Dimensioni	Çmimi
43053	160 mm	<b>390</b>

**PINCE FERMO PER  
HAPJE E KTHYER**

Kodi	Dimensioni	Çmimi
43056	18 mm	<b>450</b>

**PINCE FERMO PER  
MBYLLJE E DREJTE**

Kodi	Dimensioni	Çmimi
43057	180 mm	<b>450</b>

**PINCE FERMO PER  
MBYLLJE E KTHYER**

Kodi	Dimensioni	Çmimi
43058	180 mm	<b>450</b>

**KARROÇË PËR VEGLA  
MEKANIKE ME 4+1 KANAT**

Kodi	Permasa	Çmimi
45.101.70	670x380x724 mm	<b>19.500</b>

**KARROÇË PËR VEGLA  
MEKANIKE ME 2 KANATE**

Kodi	Permasa	Çmimi
81830	618x330x660 mm	<b>19.900</b>

**STOL MEKANIKU ME  
RROTA**

Kodi	Kapaciteti	Çmimi
81825	135 kg	<b>5.900</b>

**DOREZA NITRILE  
TE ZEZA**

Kodi	Masa	Çmimi
BPP210	S	<b>1.200</b>
BPP211	M	<b>1.200</b>

**DOREZA NITRILE  
TE ZEZA**

Kodi	Kapaciteti	Çmimi
BPP212	L	<b>1.200</b>
BPP213	XL	<b>1.200</b>

**MBAJTESE LETRE  
RULON PER SERVICE**

Kodi	Çmimi
BWR5100	me rrota <b>1.500</b>

**SET ME 6 KACAVIDA  
MEKANIKE**

Kodi	Permban	Çmimi
58106	4X100, 5X125, 6X150, PH.0X75, PH.1X75, PH.2X100	<b>990</b>

**SET KACAVIDE ME 26  
MAJA DHE KOKA KRIKETI**

Kodi	Permban	Çmimi
58126	Maja dhe koka kriketi	<b>690</b>

**SET ME 6 KACAVIDA  
PRECIZIONI**

Kodi	Permban	Çmimi
58306	6 cope	<b>450</b>



**INDIKATOR DIXHITAL  
AC/DC 12V-250 V LCD**



Kodi	Tensioni	Çmimi
5911	12V-240V	<b>290</b>

**SHARRE DORE HEKURI**



Kodi	Dimensioni	Çmimi
6601	mini	<b>250</b>

**SHARRE DORE HEKURI**



Kodi	Dimensioni	Çmimi
6602	300 mm	<b>990</b>

**SPECIMETER ME 26 FIJE**



Kodi	Permban	Çmimi
6613	26 fiije	<b>390</b>

**THIKE TAPICERIE ME 6  
LAMA REZERVE**



Kodi	Lama rezerve	Çmimi
81003	6 cope	<b>350</b>

**THIKE TAPICERIE SK5  
ME 3 LAMA REZERVE**



Kodi	Lama rezerve	Çmimi
8104	3 cope	<b>199</b>

**NXJERRES MAGNETIK  
I ZGJATUESHEM 760 MM**



Kodi	Kapaciteti	Çmimi
8109	deri ne 5 kg	<b>690</b>

**METER ME GOMINE**



Kodi	Dimensioni	Çmimi
VQ6616	5m x 19mm	<b>450</b>

**GERSHERE TELI**



Kodi	Dimensioni	Çmimi
HOUPA	150 mm	<b>450</b>

**TESTUES QARKU  
DC 6-24 V**



Kodi	Ne vlera	Çmimi
8201	Pozitiv/Negativ	<b>990</b>

**MULTIMETER DIXHITAL  
200 A**



Kodi	Amperazhi	Çmimi
VQ8207	200 A	<b>790</b>

**CELES KRYQ  
17 X 19 X 21 X 1/2"**



Kodi	Dimensioni	Çmimi
8003	17x19x21 mm	<b>990</b>

### KARROCE PER VEGLA MEKANIKE BOSH

39.900

HDTTC01072



Permasa  
Sirtare

765x465x812mm

7

### SET ME 147 VEGLA DORE

19.900

HKTHP21471



Sasia  
Valixhe

147 Copë  
Alumini

### KARROCE E KOMPLETUAR ME 162 VEGLA DORE



**162PCS/SET**  
765x465x976mm



HTCS271621  
Sirtare

69.500

7

### KARROCË PËR VEGLA MEKANIKE

8.500

HPTCT031



Permasa  
Sirtare

719 x 365 x 663 mm

3

### KARROCË PËR VEGLA MEKANIKE BOSH

14.500

HPTCT021



Permasa  
Sirtare

712 x 440 x 694 mm

2+2

### KARROCË PËR VEGLA MEKANIKE

28.500

HDTTC01042



Permasa  
Sirtare

765 x 465 x 812 mm

4 + 1 Kapake

### KARROCË PËR VEGLA MEKANIKE

28.500

HDTTC02071P



Permasa  
Sirtare

680 x 458 x 802 mm

7

**SET VALIXHE METALIKE ME 97 VEGLA DORE**



15.900

HTCS220971

Sasia

97 Copë

**SET VALIXHE PLASTIKE ME 32 VEGLA DORE**



3.390

HKTHP10321

Sasia

32 vegla dore + valixhe

**VALIXHE METALIKE VEGLASH ME 3 HAPJE**



3.990

HTB02

Permasa

Sirtare

495 x 200x 290 mm

3 sirtare

**NDRICUES LED PER MEKANIK ME BATERI 3.5 W**



2.390

HWLI35261

Bateri

3.5 W

**SET ME 14 PIPO-E 1/4", 3/8", 1/2"**



1.350

HKTETS0114

Sasia

1/4"

3/8"

1/2"

14 Pipo-E 5,

E4-5-6-7-8

E10-11-12-14-16

E18-20-22-24

**SET ME 100 VEGLA DORE (DOREZE KRIKETI 1/2" 45 T)**



12.900

HKTHP21001

Sasia

100 Copë

**SET ME VEGLA DORE 142 COPE (DOREZE KRIKETI 1/2" + 1/4")**



19.900

HKTHP21421

Sasia

142 Copë

**KOMPLET KRIKETI 46 COPE 1/4" 72T**



2.750

HKTS14462

Sasia

Kapja

46 Copë

1/4"



**KOMPLET KRIKETI 45 COPE 1/4"**

**2.990**

**HKTS14451**



Sasia  
Kapja

45 Copë  
1/4"

**KOMPLET KRIKETI 20 COPE 1/2" 45T**

**2.990**

**HKTS12201**



Sasia  
Kapja

20 Copë  
1/2"

**KOMPLET KRIKETI 62 COPE 1/2" 72T**



**5.900**

**HKTS12602**



Sasia  
Kapja

62 Copë  
1/2"

**KOMPLET KRIKETI 24 COPE 1/2" ME VALIXHE METALIKE**

**5.900**

**HKTS0243**



Sasia  
Kapja

24 Copë  
1/2"

**KOMPLET KRIKETI 25 COPE 1/2"**

**6.500**

**HKTS12251**



Sasia  
Kapja

25 Copë  
1/2"

**KOMPLET ME KOKA KRIKETI 44 COPE 1/4" + 1/2"**

**7.900**

**HKTS42441**



Sasia  
Kapja

44 Copë  
1/4" + 1/2"

**KOMPLET ME KOKA KRIKETI 94 COPE 1/4" + 1/2"**

**9.500**

**HKTS42941**



Sasia

94 Copë

**KOMPLET KRIKETI 216 COPE 1/2" 1/4" 3/8"**

**14.900**

**HKTHP22161**



Sasia

216 Copë

**KOMPLET KRIKETI 1/4" 12 COPË ME VARJE**

990

HKTS14122

Kapja  
Sasia



**KOMPLET KRIKETI 1/2" 12 COPË ME VARJE**

1.990

HKTS12122

Kapja  
Sasia



**KOMPLET KRIKETI 1/4" 27 COPË ME VARJE**

1.550

HKTS14271

Kapja  
Sasia



**KOMPLET KRIKETI 1/2" 17 COPË ME VARJE**

2.750

HKTS12171

Kapja  
Sasia



**KOMPLET KRIKETI 3/8" 12 COPË ME VARJE**

1.690

HKTS38122

Kapja  
Sasia



**SET ME 10 KOKA KRIKETI 1/2" NE VALIXHE METALIKE**

1.690

HKTS12101

Sasia  
Nr



10  
10-12-13-14-17-19-21-22-24

**SET ME 15 KOKA KRIKETI 3/4" NE VALIXHE METALIKE**

14.900

HKTS034151

Kapja  
Sasia



3/4"  
15 cope

**SET ME 120 VEGLA DORE**

6.500

HKTHP21201

Sasia



120 Copë

### DOREZE KRIKETI 1/2", 1/4", 3/8" 45T



Kodi	Permasa	Çmimi
HRTH0814	1/4" 45T	<b>550</b>
HRTH0838	3/8" 45T	<b>990</b>
HRTH0812	1/2" 45T	<b>1.150</b>

### DOREZE KRIKETI 1/2" 72T

**1.190**

HRTH8412



Dhembet  
Kapja

72 T  
1/2"

### DOREZE KRIKETI ME ZGJATIM 1/2" 72T

**ERE**

**1.690**

HRTH08128L



Dhembet  
Kapja

72 T  
1/2"

### DOREZE KRIKETI E SHKURTER 1/4" + 3/8" 72T

**ERE**

**1.190**

HRTH081438



Dhembet  
Kapja

72 T  
1/4" + 3/8"

### ZGJATUES KRIKETI 1/2" ME KEND TE LEVIZSHEM

**990**

HFXH012151

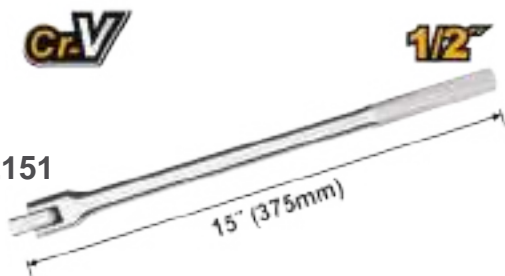

Permasa  
Kapja

375 mm  
1/2"

### LEVE KRIKETI L 1/2" ME KEND 90°

**650**

HLHD12121

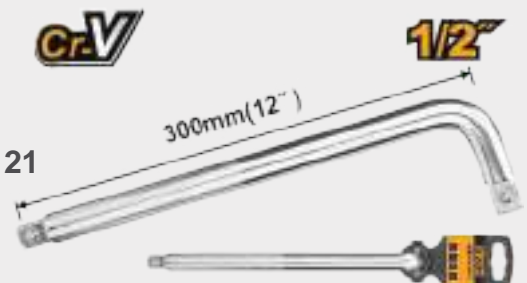

Permasa  
Kapja

300 mm  
1/2"

### LEVE KRIKETI T 1/2"

**450**

HSTB12101

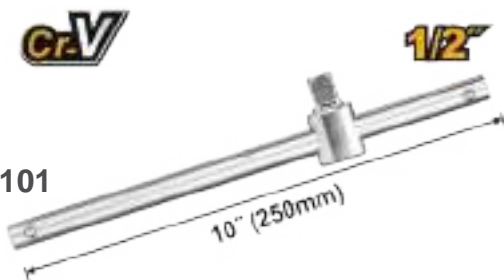

Permasa  
Kapja

250 mm  
1/2"

### ZGJATUES PER KOKA KRIKETI 1/2"

Kodi	Permasa	Çmimi
HEB12051	1/2" 127 mm	<b>390</b>
HEB12101	1/2" 254 mm	<b>650</b>



### LEVE KRIKETI T 3/4"

1.750

HSTB34181



Permasa  
Kapja

450 mm  
3/4"

### LEVE KRIKETI T 3/4"

1.450

HEB34081



Permasa  
Kapja

200 mm  
3/4"

### KOKE KRIKETI 1/2" ME 6 FAQE



Kodi	Permasa	Çmimi
HSPS12161	1/2" 16 mm	<b>180</b>
HSPS12211	1/2" 21 mm	<b>250</b>

### KRYQ KRIKETI 1/2" I LEVIZSHEM

450

HHUJ1121



Kapja

1/2"

### KOKE KRIKETI 1/2" ME 6 FAQE



Kodi	Permasa	Çmimi
HHAST12081	8 mm	<b>100</b>
HHAST12091	9 mm	<b>100</b>
HHAST12101	10 mm	<b>150</b>
HHAST12121	12 mm	<b>150</b>
HHAST12131	13 mm	<b>160</b>
HHAST12141	14 mm	<b>160</b>

### KOKE KRIKETI 1/2" ME 6 FAQE



Kodi	Permasa	Çmimi
HHAST12171	17 mm	<b>180</b>
HHAST12191	19 mm	<b>180</b>
HHAST12241	24 mm	<b>200</b>
HHAST12271	27 mm	<b>230</b>
HHAST12301	30 mm	<b>240</b>
HHAST12321	32 mm	<b>250</b>

### KOKE KRIKETI E GJATE ME 6 FAQE



Kodi	Permasa	Çmimi
HHAST12083L	8 mm	<b>230</b>
HHAST12103L	10 mm	<b>240</b>
HHAST12123L	12 mm	<b>250</b>
HHAST12133L	13 mm	<b>250</b>
HHAST12173L	17 mm	<b>250</b>

### KOKE KRIKETI E GJATE ME 6 FAQE



Kodi	Permasa	Çmimi
HHAST12193L	19 mm	<b>250</b>
HHAST12243L	24 mm	<b>320</b>
HHAST12273L	27 mm	<b>450</b>
HHAST12303L	30 mm	<b>490</b>
HHAST12323L	32 mm	<b>550</b>

### KOKE KRIKETI AJRI E GJATE

**1/2"**



Kodi	Permasa	Çmimi
HDIS12101L	10 / 78mm	<b>290</b>
HDIS12121L	12 / 78mm	<b>290</b>
HDIS12131L	13 / 78mm	<b>290</b>
HDIS12141L	14 / 78mm	<b>290</b>
HDIS12151L	15 / 78mm	<b>290</b>
HDIS12161L	16 / 78mm	<b>290</b>

### KOKE KRIKETI AJRI E GJATE

**1/2"**



Kodi	Permasa	Çmimi
HDIS12171L	17 / 78mm	<b>390</b>
HDIS12191L	19 / 78mm	<b>390</b>
HDIS12211L	21 / 78mm	<b>390</b>
HDIS12221L	22 / 78mm	<b>390</b>
HDIS12241L	24 / 78mm	<b>390</b>
HDIS12271L	27 / 78mm	<b>390</b>

### KOKE KRIKETI AJRI E GJATE

**3/4"**



Kodi	Permasa	Çmimi
HHIS3419L	3/4" 19 / 90mm	<b>790</b>
HHIS3421L	3/4" 21 / 90mm	<b>790</b>
HHIS3422L	3/4" 22 / 90mm	<b>790</b>
HHIS3423L	3/4" 23 / 90mm	<b>790</b>

### KOKE KRIKETI AJRI E GJATE

**3/4"**



Kodi	Permasa	Çmimi
HHIS3424L	3/4" 24 / 90mm	<b>790</b>
HHIS3427L	3/4" 27 / 90mm	<b>790</b>
HHIS3430L	3/4" 30 / 90mm	<b>790</b>
HHIS3432L	3/4" 32 / 90mm	<b>790</b>

### SET ME 10 KOKA KRIKETI ME GODITJE

**1/2"**



**1.690**

**HKISSD12101**

Permasa: 10.12.13.14.15.17.19.21.22.24 mm  
Nr faqeve: 6 faqe

### SET ME 10 KOKA KRIKETI TE GJATA

**1/2"**



**2.950**

**HKISSD12102L**

Permasa: 10.12.13.14.15.17.19.21.22.24 mm  
Gjatesia: 78 mm

### ADAPTOR PER KOKA KRIKETI

**1/2" F - 3/4" M**

**IRI**



**550**

**HIA12341**

Kapja

1/2" F - 3/4" M

### ADAPTOR AJRI 1/2" F - 1/4" F HEXAGON

**IRI**

**1/2" Square drive to 1/4" Hex**



**390**

**ABH60501**

Kapja

1/2" F - 1/4" F

### KOMPLET ME 6 ÇELESA FISO-STEL KRIKET

**IRI**

**1.690**

**HKSPAR1062**



Sasia 6 Copë  
Nr 8-10-12-13-14-17 mm

### SET ME 6 ÇELESA FISO-STEL

**790**

**HKSPA1068**



Sasia 6 Copë  
Nr 8-10-12-13-14-17 mm

### KOMPLET ME 8 ÇELESA FISO-STEL

**1.350**

**HKSPA1088**



Permasa 6, 8, 10, 12, 14, 15, 17, 19 mm  
Sasia 8 Copë

### KOMPLET ME 8 ÇELESA FISO-STEL

**1.350**

**HKSPA1088-I**



Permasa 6, 8, 10, 13, 14, 15, 17, 19 mm  
Sasia 8 Copë

### SET ME 12 ÇELESA FISO-STEL

**2.490**

**HKSPA1142**



Permasa 6, 8, 10, 11, 12, 13, 14, 15, 17, 19, 22, 24 mm  
Sasia 12 copë

### KOMPLET ME 12 ÇELESA FISO-STEL

**3.950**

**HKSPA1143**



Permasa 6, 8, 10, 12, 14, 17, 19, 22, 24, 27, 30, 32 mm  
Sasia 12 copë

### CELES FISO-STEL



Kodi	Permasa	Çmimi
HCSPA061	6 mm	<b>100</b>
HCSPA081	8 mm	<b>130</b>
HCSPA101	10 mm	<b>150</b>
HCSPA121	12 mm	<b>160</b>
HCSPA131	13 mm	<b>180</b>
HCSPA141	14 mm	<b>180</b>
HCSPA151	15 mm	<b>190</b>

### CELES FISO-STEL



Kodi	Permasa	Çmimi
HCSPA171	17 mm	<b>230</b>
HCSPA191	19 mm	<b>270</b>
HCSPA221	22 mm	<b>350</b>
HCSPA241	24 mm	<b>450</b>
HCSPA271	27 mm	<b>690</b>
HCSPA301	30 mm	<b>790</b>
HCSPA321	32 mm	<b>850</b>



## CELES FISO-STEL KRIKET

**I RI**



Kodi	Permasa	Çmimi
HCSPAR061	6 mm	<b>270</b>
HCSPAR081	8 mm	<b>320</b>
HCSPAR101	10 mm	<b>390</b>
HCSPAR121	12 mm	<b>420</b>
HCSPAR131	13 mm	<b>490</b>
HCSPAR141	14 mm	<b>550</b>

## CELES FISO-STEL KRIKET

**I RI**



Kodi	Permasa	Çmimi
HCSPAR171	17 mm	<b>650</b>
HCSPAR191	19 mm	<b>690</b>
HCSPAR211	21 mm	<b>690</b>
HCSPAR241	24 mm	<b>990</b>
HCSPAR271	27 mm	<b>990</b>

## KOMPLET ME 8 ÇELESA FISO-STEL KRIKET

**3.500**

**HKSPAR1082**



Permasa 8-19 mm  
Sasia 8 Copë

## KOMPLET ME 6 CELESA FISO-STEL KRIKET 19-32 MM

**5.900**

**HKSPAR1061**



Permasa 19,22,24,27,30,32 mm  
Sasia 6 Copë

## KOMPLET ME 8 ÇELESA FISO-STEL KRIKET ME KEND

**3.950**

**HKSPAR1083**



Permasa 8,10,12,13,14,15,17,19 mm  
Sasia 8 Copë

## KOMPLET ME 8 ÇELESA POLIGON / 6-22 MM

**1.690**

**HKSPA3088**



Permasa 6x7,8x9,10x11,12x13,14x15,16x17,18x19,20x22mm  
Sasia 8 Copë

## CELES TUBOLAR L

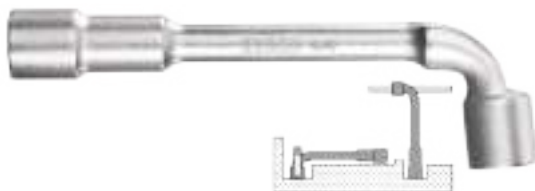

Kodi	Permasa	Çmimi
HWL1008	10 mm	<b>350</b>
HWL1208	12 mm	<b>400</b>
HWL1308	13 mm	<b>450</b>
HWL1408	14 mm	<b>500</b>
HWL1708	17 mm	<b>690</b>

## KOMPLET ME 6 ÇELESA TUBOLAR L - 1/2"

**1.690**

**LASWT0601**



Permban (7, 8, 10, 12, 13, 14 mm)

**SET ME ÇELESA TUBOLAR L, 9 COPË**

**2.990**

**LASWT0901**



Sasia 6 Copë  
Nr 8-10-12-13-14-17 mm

**KRYQ PER MAKINA 16" ME 4 KOKA KRIKETI 1/2"**

**2.390**

**HRCW40231**



Permasa 17/19/21/23 mm

**ÇELËS DINANOMETRIK 1/2"**

**9.500**

**HPTW200N1**



Gjatesia 530 mm  
Shtrengimi 40-200 N.m

**ÇELËS DINANOMETRIK 1/2"**

**1.090**

**HPTW300N1**



Kapja 1/2"  
Shtrengimi 0-300 N.m

**CELES KRIKETI PER SKELA**



**990**

**HRSTW17191**



Permasa 17 / 19 mm

**CELES KRIKETI PER SKELA**



**990**

**HRSTW19211**



Permasa 19 / 21 mm

**SET ME 5 SHFILETUESE**

**690**

**ASE008**



Permasa 3~6mm,6~8mm,8~11mm, 11~14mm,14~18mm

**SET FILETIMI 40 COPE NE VALIXHE METALIKE**

**2.900**

**ATAD0402**



Meshkujt / Femra M3-M12

### ÇELES UNIVERSAL I SHPEJTE

9-14mm+15-22mm  
23-32mm

990

HBWS110808



Open Width 23-32mm    Open Width 9-14mm    Open Width 15-22mm

Permasa (1 cope i hapur nga 2 anet 9-14 mm, 15-22 mm)  
1 cope i hapur nga 1 ane 23-32 mm)

### CELES ANGLEZ ME HAPJE TE MADHE

**IRI**

1.990

HADWG0810



Extra wide opening wrench 250mm (10")  
CrV  
0-52mm



2Pcs jaw protector included



Adjustable Wrench



Pipe Wrench

Permasa

10" / 250 mm  
0 - 52 mm

### EKSTRATOR ME 2 KRAHE

1.190

HGP08023



Permasa

80 mm / 2000 kg

### EKSTRATOR ME 2 KRAHE

1.450

HGP08024

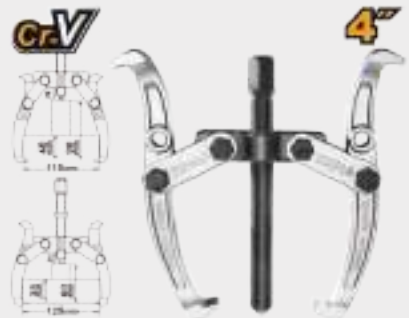

Permasa

115 mm / 3000 kg

### EKSTRATOR ME 2 KRAHE

2.490

HGP08026



Permasa

160 mm / 5000 kg

### EKSTRATOR ME 3 KRAHE

1.350

HGP08033



Permasa

75 mm / 3000 kg

### EKSTRATOR ME 3 KRAHE

1.690

HGP08034



Permasa

120 mm / 4000 kg

### EKSTRATOR ME 3 KRAHE

3.390

HGP08036



Permasa

175 mm / 6000 kg



### PISTOLET GRASATIMI E ZEZE 400 GR

1.690

GRG015001



Presioni

4500 Psi  
400 cc

### PISTOLETE GRASATIMI ME DOPIO PISTON 400 GR

2.490

GRG015002



Presioni

3600 Psi  
400 cc

### TUB FLEKSIBEL NEJLONI ME THURJE PER PISTOLETE GRASATIMI



890

GRG015002/1



Permasa

300 mm

### MORSETE BANGO E RROTULLUESHME 4"

100mm(4")

4.500

HBV084



Permasa

100 mm

Rrotullimi

360°

Forca shtrenguese

1300 kg

### MORSETE BANGO E RROTULLUESHME 6"

150mm(6")

8.900

HBV086



Permasa



Ductile Cast Iron

150 mm

Forca shtrenguese

1600 kg

### MORSETE BANGO E RROTULLUESHME 8"

200mm(8")

14.500

HBV088



Permasa



Ductile Cast Iron

200 mm

Forca shtrenguese

2500 kg

### MORSETE BANGO E RROTULLUESHME 5"

125mm(5")

17.500

HBV085



Permasa



Ductile Cast Iron

125 mm

Forca shtrenguese

2000 kg

### MORSETE BANGO E RROTULLUESHME 360°

60mm  
(2-3/8")

1.990

HBV082



Forca shtrenguese

360°



Per kapje

1000 Kg

60 mm



**VEGLA DORE  
DHE AKSESORË NDËRTIMI**

### PINCE UNIVERSALE



Kodi	Permasa	Çmimi
HCP08168	6" / 160 mm	440
HCP08188	7" / 180 mm	450
HCP08208	8" / 200 mm	490

### PINCE UNIVERSALE PROFI



Kodi	Permasa	Çmimi
HCP28168	6" / 160 mm	530
HCP28188	7" / 180 mm	630
HCP28208	8" / 200 mm	690

### PINCE UNIVERSALE KRAFT



Kodi	Permasa	Çmimi
HHCP28160	6" / 160 mm	550
HHCP28180	7" / 180 mm	690
HHCP28200	8" / 200 mm	800

### PINCE MEKANIKE INDUSTRIALE 9.5"



Kodi	Permasa	Çmimi
HHCP28240	240 mm	990

### PINCE UNIVERSALE



Kodi	Permasa	Çmimi
HCP12160	6" / 160 mm	420
HCP12200	8" / 200 mm	440

### PINCE ME MAJE TE GJATE

540

HLNP28168



Permasa

160 mm

6"

### PINCE ME MAJE TE GJATE

**ERE**



Kodi	Permasa	Çmimi
HLNP08168	6" / 160 mm	350
HLNP08208	8" / 200 mm	450

### PINCE PROFI ME MAJE TE GJATE

530

HHLNP28160



Permasa

160 mm

6"



### PINCE PROFI ME MAJE TE GJATE

630

HHLNP28200



Permasa

200 mm  
8"

### PINCE MEKANIKE ME MAJE TE KTHYER 6"

600

HBNP28168



Permasa

160 mm  
6"

### PINCE MEKANIKE ME MAJE TE KTHYER 6"

**E RE**

360

HBNP08168



Permasa

160 mm  
6"

### TRONKEZE UNIVERSALE DOREZE ME 2 KOMPONENTE



Kodi	Permasa	Çmimi
HDCP08168	6" / 160 mm	<b>450</b>
HDCP08188	7" / 180 mm	<b>530</b>

### TRONKEZE PROFI DOREZE ME 2 KOMPONENTE



Kodi	Permasa	Çmimi
HDCP28168	6" / 160 mm	<b>530</b>
HDCP28188	7" / 180 mm	<b>630</b>

### TRONKEZE KRAFT

530

HHDCP08188



Permasa

180mm  
7"

### TRONKEZE SUPER PROFI



Kodi	Permasa	Çmimi
HHLDCP28160	6" / 160 mm	<b>630</b>
HHLDCP28180	7" / 180 mm	<b>690</b>

### TRONKEZE PROFI ME NOFULL TE GJERE

690

HHHDCP28180



Permasa

180 mm  
7"

**SET ME 3 PINCA PROFI UNIVERSALE**

160mm(6")  
160mm(6")  
200mm(8")

**3PCS/SET**

**990**

**HKPS08318**



Tronkeze 6" / Pince me maje te gjate 6" / Pince 8"  
(160 / 160 /200)

**SET ME 3 PINCA PROFI UNIVERSALE**

160mm(6")  
160mm(6")  
200mm(8")

**3PCS/SET**

**1.450**

**HKPS28318**



Pince me maje te gjate 6" / Tronkeze 6" / Pince 8"  
(160 / 160 /200)

**SET ME 3 PINCA PROFI**

**1.950**

**HKHLPS2832**



Pince me maje te gjate 7" , Tronkeze 8" , Pince 9.5"

**SET ME 3 PINCA**

**1.690**

**HKHLPS2831**



Pince me maje te gjate 6" , Tronkeze 7" , Pince 8"  
Doreze me 2 komponente

**SET ME 2 PINCA  
(PINCE 7" + TRONKEZE 6")  
SUPER SELECT**

**E RE**

**690**

**HKPS08212**



(Pince 7" + Tronkeze 6")

**SET ME 3 PINCA ME DOREZE PLASTIKE**

**990**

**HKPS08311**



Pince universale 8"  
Trokeze 6", pince me maje te gjate 6"

**PINCE HIDRAULIKE ME BUTON  
E VESHUR 10"**

**1.250**

**HPP68258**



Permasat

250 mm  
10"

**PINCE HIDRAULIKE E VESHUR 10"  
E ZEZE**

**690**

**HPP28258**



Permasat

250 mm  
10"

### PINCE HIDRAULIKE E VESHUR 10"

690

HPP28251



Permasa

250 mm  
10"

### PINCE HIDRAULIKE E DREJTE E VESHUR 12"DORE

890

HPP03300

**CrV 300mm(12")**

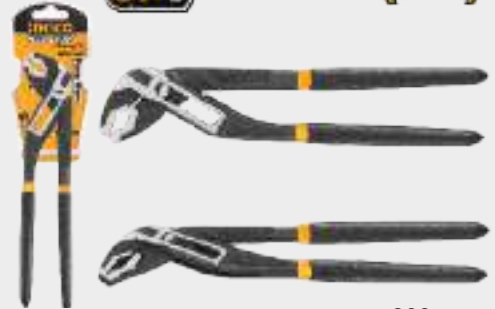

Permasa

300 mm  
12"

### DARE KARPENTIERI E VESHUR ME KOKE TE GJERE



Kodi

Permasa

Çmimi

HECP02160

6" / 160 mm

**500**

### DARE KARPENTIERI E VESHUR ME KOKE TE GJERE

**CrV 180mm(7")**



Kodi

Permasa

Çmimi

HECP02180

7" / 180 mm

**630**

### DARE PROFI PER TEL

**E RE**

690

HECP28200

**CrV 200mm(8")**



Permasa

200 mm  
8"

### DARE PROFI PER TEL

630

HECP28160



Permasa

160 mm  
6"

### DARA KARPENTIERI TE VESHURA



Kodi

Permasa

Çmimi

HRP02200

8" / 220 mm

**490**

### DARA KARPENTIERI TE VESHURA



Kodi

Permasa

Çmimi

HRP02230

9" / 230 mm

**490**



### PRERESE KABULLI E VESHUR



Kodi	Permasa	Çmimi
HCCB0208	8" / 200 mm	<b>530</b>

### PRERESE KABULLI E VESHUR



Kodi	Permasa	Çmimi
HHCCB0210	10" / 240 mm	<b>650</b>

### SET ME 6 MINI PINCA

1.550

HMP506115



Permban Sasia 115 mm / 1.5" 6 cope

### SET ME 15 VEGLA PRECIZIONI

2.390

HKTTS0151



Permban Kacavida me maje pete, Ph, Torx

### PINCE FERMO HAPJE ME MAJE TE KTHYER

**E RE**



Kodi	Permasa	Çmimi
HCCP261801	7" / 180 mm	<b>490</b>
HCCP261802	7" / 180 mm	<b>490</b>
HCCP261804	7" / 180 mm	<b>490</b>

### PINCE FERMO ME MBYLLJE ME MAJE TE DREJTE

**E RE**



790  
HCCP261803

Permasa 180 mm 7"

### SET ME 4 PINCA FERMO 5" ME DOREZE TE VERDHE

1.690

HCCPS26125



Permasa 150 mm 2 cp 180°, 2 cp 90°

### SET ME 4 PINCA FERMO 7" ME DOREZE TE VERDHE

1.690

HCCPS26180



Permasa 180 mm 2 cp 180°, 2 cp 90°

**SET ME 4 PINCA FERMO ME DOREZE TE ZEZE**

**1.690**

**HCCPS01180**



Permasa

2 CP 180° / 2 CP 90° 7"  
180 mm

**PINCE ZHVESHESE KABULLI**

**590**

**HWSP28160**



Permasa

160 mm  
6"

**PINCE ZHVESHESE KABELLI**

**ERE**

**890**

**HWSP101**



Permasa  
Kabell

254 mm 10"  
1-2.5 mm

**ZHVESHESE TELI AUTOMATIKE**

**990**

**HWSP15608**



Per kabuj

0.5mm - 6mm

**ZHVESHESE TELI 180 MM**

**790**

**HWSP04**



Permasa

180 mm  
7"

**ZHVESHESE KABLLI AUTOMATIKE 3 NE 1 FUNKSIONE**

**1.250**

**HWSP102418**



Funksionet:

Prerje, zhveshje dhe shtrengim kablli

**PRESE KAPIKORDASH DHE TELEFONI**

**ERE**

**790**

**HMPC1468P**



Permasa

200 mm  
8" (4P, 6P, 8P)

**PRESE KAPIKORDASH DHE TELEFONI ME KRIKET**

**ERE**

**890**

**HMPCN2468R**



Permasa

200 mm  
8" (4P, 6P, 8P)

### ÇELES HIDRAULIK PAPAGALL ALUMINI

1.950

HALPW0114



Permasa  
Hapja

350 mm  
50 mm

### ÇELES HIDRAULIK PAPAGALL ALUMINI

2.990

HALPW0118



Permasa  
Hapja

450mm  
60 mm

**Max Ø60mm Stronger**

### ÇELES HIDRAULIK PAPAGALL ALUMINI

4.690

HALPW0124



Permasa  
Hapja

600mm  
76 mm

**Max Ø76mm Stronger**

### ÇELES HIDRAULIK KRIKET ME QAFE



Kodi	Permasa	Çmimi
HPW1410	250 mm / 10"	<b>1.450</b>
HPW1414	350 mm / 14"	<b>2.150</b>

### ÇELES HIDRAULIK PAPAGALL



Kodi	Permasa	Çmimi
HPW0808	200 mm / 8"	<b>690</b>
HPW0810	250 mm / 10"	<b>790</b>
HPW0812	300 mm / 12"	<b>990</b>
HPW0814	350 mm / 14"	<b>1.250</b>

### ÇELES HIDRAULIK PAPAGALL



Kodi	Permasa	Çmimi
HPW0818	450 mm / 18"	<b>1.590</b>
HPW0824	600 mm / 24"	<b>2.490</b>
HPW0836	900 mm / 36"	<b>4.450</b>
HPW0848	1200 mm / 48"	<b>5.850</b>

### ÇELES HIDRAULIK 90° 1" / 1.5" / 2"



Kodi	Permasa	Çmimi
HPW04011	40 mm 1"	<b>990</b>
HPW04151	55 mm 1.5"	<b>1.450</b>
HPW04021	67 mm 2"	<b>2.490</b>

### ÇELES HIDRAULIK SUEDEZ 45° 1" / 1/2" 2"



Kodi	Permasa	Çmimi
HPW04013	1 / 45°	<b>990</b>
HPW04153	1 1/2 - 45°	<b>1.590</b>
HPW04023	2 - 45°	<b>2.490</b>



### ÇELES ANGLEZ



45#CS



0-

Kodi	Permasa	Çmimi
HADW131062	150 mm / 6"	<b>380</b>
HADW131082	200 mm / 8"	<b>630</b>
HADW131102	250 mm / 10"	<b>690</b>

### ÇELES ANGLEZ ME DOREZE ME 2 KOMPONENTE



CrV



0-24mm

Kodi	Permasa	Çmimi
HADW131068	150 mm / 6"	<b>630</b>
HADW131088	200 mm / 8"	<b>810</b>

### SET ME 3 ÇELES ANGLEZ

**1.690**

HADWK031



6"  
8"  
10"

**SUPER SELECT**

Permasa

6" / 8" / 10"

### GERSHERE LLAMARINE E DREJTE

**690**

HTSN0110S



Permasa

250 mm  
10"

### ÇELES ANGLEZ



45#CS

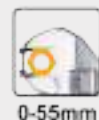

0-55mm

Kodi	Permasa	Çmimi
HADW131122	300 mm / 12"	<b>1.190</b>
HADW131152	375 mm / 15"	<b>1.890</b>
HADW131182	450 mm / 18"	<b>3.150</b>

### ÇELES ANGLEZ ME DOREZE ME 2 KOMPONENTE



CrV



0-41mm

Kodi	Permasa	Çmimi
HADW131108	250 mm / 10"	<b>1.190</b>
HADW131128	300 mm / 12"	<b>1.690</b>

### PRERESE GOZHDE DHE TELI

**530**

HFP2508



**250mm(10")**

Permasa

250 mm  
10"

### GERSHERE LLAMARINE E DREJTE PROFI

**990**

HTSN2610S



**Cr-Mo**



**Longer lifetime**

Permasa

250 mm  
10"

### GERSHERE LLAMARINE MAJTAS

690

HTSN0110L

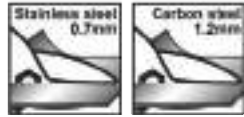
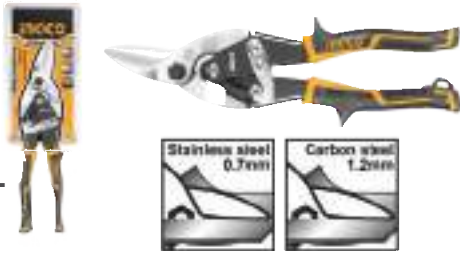

Permasa

250 mm  
10"

### GERSHERE LLAMARINE MAJTAS PROFI

890

HTSN2610L



Permasa

250 mm  
10"

### GERSHERE LLAMARINE DJATHTAS

690

HTSN0110R



Permasa

250 mm  
10"

### GERSHERE LLAMARINE DJATHTAS PROFI

890

HTSN2610R



Permasa

250 mm  
10"

### GERSHERE LLAMARINE E DREJTE E GJATE

990

HTSN0112S



Permasa

300 mm  
12"

### SET ME 3 GERSHERE LLAMARINE

1.690

HTSNK0110

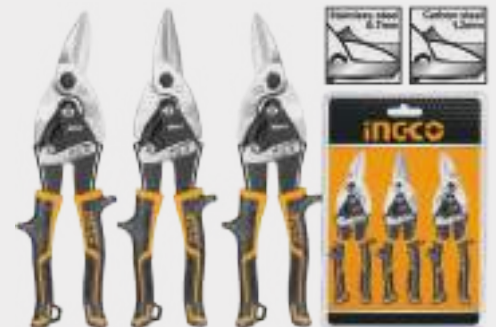

Permasa

250 mm / 10"

Prerja

Majtas, djathtas, drejte

### GERSHERE LLAMARINE



Kodi	Permasa	Çmimi
HTS0410	10" - 250 mm	690
HTS0412	12" - 300 mm	990

### GERSHERE LLAMARINE INDUSTRIALE



Kodi	Permasa	Çmimi
HTS2610	10" - 250 mm	990
HTS2612	12" - 300 mm	1.350

### GERSHERE ELEKTRICISTI ME TEH INOXI

**630**

**HES0188**



Permasa

200 mm  
8"

### SET PINCE PER HAPJEN E TUBAVE TE BAKRIT

**1.250**

**HPFT71**

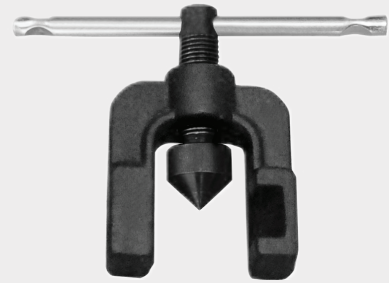

Permasa 5mm / 6mm / 8mm / 10mm / 12mm / 14mm / 16mm  
Per kondicionere

### PRERESE TUBI PLASTIK

**990**

**HPC0442**



Permasa  
Prerja

225 mm  
3-42 mm

### PRERESE TUBI PLASTIK ME HAPJE AUTOMATIKE

**690**

**HPCS05428**



Permasa  
Per prerje

193 mm  
3-42 mm

### PRERESE TUBI BAKRI / ALUMINI / PVC

**790**

**HPC0232**



Prerja

3-32 mm

### PRERESE PER TUBA 10 - 42 MM

**2.490**

**HPC0142**



Permasa

10-42 mm

### GERSHERE TELI



Comfortable  
Rubber Handle

Kodi	Permasa	Çmimi
<b>HBC0812</b>	12-300 mm	<b>1.390</b>
<b>HBC0814</b>	14 350 mm	<b>1.590</b>

### GERSHERE TELI

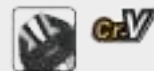

Comfortable  
Rubber Handle

Kodi	Permasa	Çmimi
<b>HBC0818</b>	18-450 mm	<b>1.950</b>
<b>HBC0824</b>	24-600 mm	<b>2.150</b>



### GERSHERE TELI



Kodi	Permasa	Çmimi
HBC0830	30" - 750mm	<b>3.390</b>
HBC0836	36" - 900mm	<b>4.690</b>
HBC0842	42" - 1000 mm	<b>6.790</b>
HBC0848	48" - 1200 mm	<b>7.690</b>

### GERSHERE TELI MINI



540

HMBC0808

Permasa

200 mm / 8"

Doreze me 2 komponente

### PINCE SHTRËNGUESE ME ZINXHIR



1.550

HCLP0210

Permasa

470 mm

18.5"

### PINCE VETESHTRENGUESE ME MAJE TE GJATE



630

HLNP0209

Permasa

225 mm

9"

### PINCE VETESHTRENGUESE



630

HCJLW0210

Permasa

254 mm

10"

### PINCE VETESHTRENGUESE E GJERE



890

HCCLW0211

Permasa

280 mm

11"

### MORSETE SHTRËNGUESE PLASTIKE



1.690

HQBC24802

Permasa

80 x 600 mm

32"

### MORSETE SHTRËNGUESE PLASTIKE



2150

HQBC36803

Permasa

80 x 900 mm

36"

## MORSETE MARANGOZI DORE



Kodi	Permasa	Çmimi
HGC0105	50 x 125 mm	<b>990</b>
HGC0106	50 x 150 mm	<b>1.100</b>

## MORSETE MARANGOZI DORE



Kodi	Permasa	Çmimi
HQSC0204	110 mm 4"	<b>90</b>
HQSC0206	150 mm 6"	<b>140</b>

## MORSETE SHTRENGUESE PLASTIKE



Kodi	Permasa	Çmimi
HQBC01601	63 x 150 mm (6")	<b>530</b>
HQBC01602	63 x 300 mm (12")	<b>630</b>
HQBC01603	63 x 450 mm (18")	<b>690</b>

## MORSETE MARANGOZI INDUSTRIALE



Kodi	Permasa	Çmimi
HFC020501	50 x 150 mm	<b>530</b>
HFC020502	50 x 200 mm	<b>540</b>
HFC020503	50 x 250 mm	<b>600</b>

## MORSETE MARANGOZI INDUSTRIALE



Kodi	Permasa	Çmimi
HFC020802	80 x 300 mm	<b>890</b>
HFC021201	120 x 300 mm	<b>1.450</b>

## MORSETE MARANGOZI INDUSTRIALE



Kodi	Permasa	Çmimi
HFC021204	120 x 400 mm	<b>1.690</b>
HFC021202	120 x 500 mm	<b>1.690</b>

## MORSETE MARANGOZI INDUSTRIALE



Kodi	Permasa	Çmimi
HFC021205	120 x 600 mm	<b>1.690</b>
HFC021203	120 x 800 mm	<b>2.150</b>

## MORSETE MARANGOZI INDUSTRIALE



Kodi	Permasa	Çmimi
HFC021404	140 x 1000 mm	<b>3.990</b>
HFC021401	140 x 1200 mm	<b>3.990</b>

### KAÇAVIDE MEKANIKE MAGNETIKE ME MAJE PETE

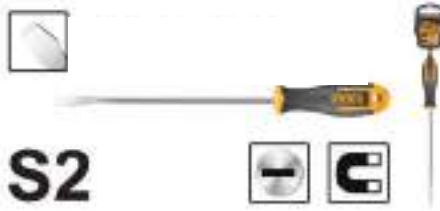

Kodi	Permasa	Çmimi
HS684100	4.0 mm x 150 mm	<b>120</b>
HS685100	5.5 mm x 100 mm	<b>140</b>
HSDSL5100	5.5 mm x 100 mm	<b>150</b>

### KAÇAVIDE MEKANIKE MAGNETIKE ME MAJE PETE

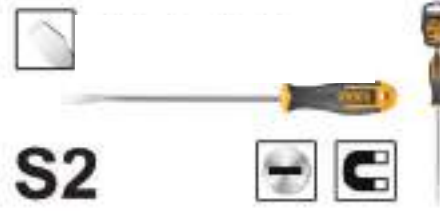

Kodi	Permasa	Çmimi
HSDSL6150	6.5 mm x 150 mm	<b>190</b>
HS688150	8.0 mm x 150 mm	<b>190</b>

### KAÇAVIDE MEKANIKE ME 2 KOMPONENTE PH



Kodi	Permasa	Çmimi
HS68PH1100	PH1 x 100 mm	<b>120</b>
HS68PH2125	PH2 x 125 mm	<b>180</b>
HS68PH2150	PH2 x 150 mm	<b>220</b>
HS68PH3200	PH3 x 200 mm	<b>270</b>

### KAÇAVIDE MEKANIKE ME 2 KOMPONENTE PZ



Kodi	Permasa	Çmimi
HS68PZ1100	PZ1 x 100 mm	<b>150</b>
HSPDZ2150	PZ2 x 150 mm	<b>230</b>

### KAÇAVIDE PH2 ME DOREZE ME 2 KOMPONENTE

**160**

HS68PH2038  
HSDPH2038



Permasa PH2 x 6.0 mm  
Gjatesia 38 mm

### KAÇAVIDE MEKANIKE MAGNETIKE ME MAJE PETE



Kodi	Permasa	Çmimi
HS686150	6.5 mm x 150 mm	<b>180</b>
HS688200	8.0 mm x 200 mm	<b>280</b>

### KAÇAVIDE MEKANIKE ME GODITJE PH2

**270**

HGTSPH2150



Permasa PH2 x 150 mm

### KAÇAVIDE MEKANIKE TORX



Kodi	Permasa	Çmimi
HSDX10100	T10 x 100 mm	<b>150</b>



### KAÇAVIDE MEKANIKE TORX



T20X150mm

**S2**

**E RE**

Kodi	Permasa	Çmimi
HSDX20150	T20 x 150 mm	<b>180</b>

### SET ME 2 KAÇAVIDA TE TEMPERUARA CR-V



**2PCS/SET**

290

HKSD0248

Sasia

2 Copë

SL6.5\*6\*125 / PH2\*6\*125

### SET ME 2 KAÇAVIDA MAGNETIKE



530

HSGT680208

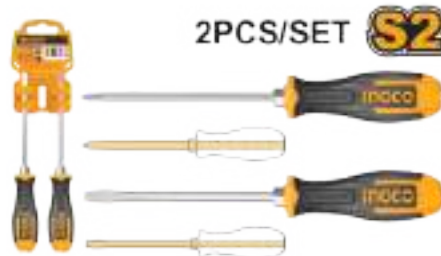

**2PCS/SET**

**S2**

Sasia

SL6.5\*6\*125 / PH2\*6\*125

2 Cope

### SET ME 4 KAÇAVIDA



**4PCS/SET**

530

HKSD0428

Permasat

SL5X100mm, SL6X150mm

PH1X100mm, PH2X150mm

### SET ME 6 KAÇAVIDA MEKANIKE



**6PCS/SET**

Soft Grip

630

HKSD0628

Sasia

6 Copë

Doreze me 2 komponente

### SET ME 5 KAÇAVIDA



**5PCS/SET**

530

HKSD0528

Permasat

Super Select

### SET ME 8 KAÇAVIDA MEKANIKE



**8PCS/SET**

Soft Grip

990

HKSD0828

Sasia

8 Copë

Doreze me 2 komponente

### SET ME 10 KAÇAVIDA



**10PCS/SET**

Soft Grip

1.690

HKSD1028

1pcs SL3.0\*3\*75 , SL4.0\*4\*100, SL5.5\*5\*125, SL6.5\*6\*150, SL8.0\*8\*200, SL6.5\*6\*38, PH0\*3\*60, PH1\*5\*80, PH2\*6\*100, PH3\*8\*150

### SET ME 18 KAÇAVIDA

1.450

HKSD1828



Kaçavida precizioni  
Kaçavida mekanike

10 Copë  
8 Copë

### SET KACAVIDE + 9 MAJA

690

AKISD0901



Permban

3 Copë: SL3X65 SL5X65 SL6X65

3 Copë: PH0X65 PH1X65 PH2X65

1 Copë 5X65 heqëse kapësesh, 1Copë 3X65 shenjuese

### SET KAÇAVIDE 18 NE 1

1.250

AKISD0181



Permasa

SL4 SL5 SL6 / PH0 PH1 PH2 / PZ1 PZ2  
T10 T15 T20 T30 / H3 H4 H5 H6 / S1 S2

### SET ME 14 KAÇAVIDA PREÇIZIONI

1.450

HKSD1428



Sasia

8 copë kaçavida

6 copë kaçavida precizioni

### SET ME 24 MAJA KAÇAVIDE

790

HKSDB0248



Sasia

24 Maja

### SET ME 26 KAÇAVIDA MEKANIKE

2.990

HKSD2628



Permban

11 kaçavida me maje te sheshte

10 kaçavida philips, 5 kaçavida precizioni

### SET ME 100 KAÇAVIDA MEKANIKE

2.990

HKSD10028



Sasia

100 cope

### KAÇAVIDE 2 NE 1 E SHKURTER

180

AKISD0202



Permasa

6.35 x 75 mm

Modeli

PH2+SL6

### KAÇAVIDE 2 NE 1 E GJATE

250

AKISD0201



Sasia

6.35 x 160mm / PH2 + SL6  
2 Cope

### KAÇAVIDE 6 NE 1 - NGA TE 2 ANET

360

AKISD0608



Permasat

PH1 + SL5 - 6.35 x 65 mm / 6 mm  
PH2 + SL62 - 8.00 x 75 mm / 8mm

### SET TAF KRIKET + MAJA

690

HKSDB0188



Permasa

15 x 6.35x25MM CR-V maja SL3,SL4,SL5,SL6,  
PH0,PH1,PH2,PH3,PZ1,PZ2,T15,T20,H4,H5,H6

### SET ME 26 MAJA DHE ADAPTOR

1.150

HKSDB0268



Materiali

CR-V

### KAÇAVIDE KRIKET ME 8 MAJA

530

AKISD0808



Permasa

SL5,SL6 / PH1, PH2, PH3 / T15, T20  
Maja 8 cope

### SET KAÇAVIDE KRIKET 13 NE 1

630

AKISD1208



SL4,SL5,SL6, SL7 / PH0,PH1,PH2,PH3 / PZ0,PZ1,PZ2,PZ3

### KOMPLET ME 7 KAÇAVIDA PRECIZIONI

690

HKSD0718



Sasia

7 Copë

SL2.0X50, SL2X50,SL3X50 / PH00X50, PH0X50 / T6X50, T8X50

### SET ME 32 MAJA KAÇAVIDE DHE PRECIZIONI

990

HKSDB0348



Sasia

32 Maja



### SET KAÇAVIDE KRIKET ME 55 MAJA

1.450

HKSD0558



Sasia

55 Maja

### SET ME 6 KAÇAVIDA PRECIZIONI

450

HKSD0618



Permasa

SL2.0\*50, SL2.5\*50, SL3.0\*50  
PH000\*50, PH00\*50, PH0\*50

### SET ME 32 MAJA PRECIZIONI DHE KAÇAVIDE

690

HKSD0328



Maja

32 Cope

### KAÇAVIDE ME DOREZE PLASTIKE PH2

100

HS58PH2125



Permasa

PH2 x 125

### KAÇAVIDE ME MAJE PETE ME DOREZE PLASTIKE

90

HS585100



Permasa

5.0 x 100 mm

### SET ME 2 KAÇAVIDA ME DOREZE PLASTIKE

290

HKSD0258



Permban

Maje Pete 6x125 mm  
PH2x125 mm

### SET ME 4 KAÇAVIDA ME DOREZE PLASTIKE

350

HKSD0458

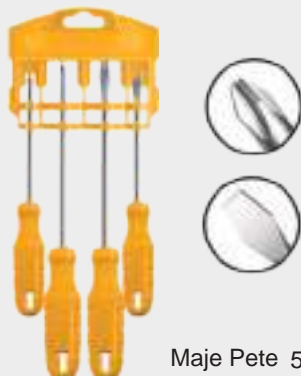

Permban

Maje Pete 5x100/ 6x125  
PH1x100/PH2x150

### SET ME 6 KAÇAVIDA ME GODITJE

990

HSGTDC180601



Permasa

SL5.5\*75mm, SL6.5\*100mm, SL8.0\*150mm  
PH1\*75mm, PH2\*100mm, PH3\*150mm

### SET ME 8 KAÇAVIDA

790

HKSD0858



Permasa SL3.0\*3\*75, SL5.5\*5\*100, SL6.5\*6\*150, SL6.5\*6\*38  
PH0\*3\*75, PH1\*5\*75, PH2\*6\*125, PH2\*6\*38

### SET ME 26 KAÇAVIDA

1.990

HKSD2658



Sasia

26 Cope  
Maja 8 cope

### SET ME 10 KAÇAVIDA + PREÇIZIONI

690

HKSD1058



Permasat

SL5X75mm, SL5X100mm, SL6X150mm  
PH1X75mm, PH1X100mm, PH2X150mm  
SL3\*50, PH0\*50, T6\*50, T8\*50

### SET ME 24 KAÇAVIDA DHE MAJA

890

HKSDB02482



Sasia

14 copë kacavida  
10 copë maja

### KACAVIDE FLEKSIBEL ME 12 MAJA

580

AKSDFL1208



Permasa

SL5, SL6, SL7, PH1, PH2, PH3, T10, T15,  
T20, T25

### SET ME 67 VEGLA DORE NE VALIXHE

3.850

HKTAC010671



Sasia

67 Aksesore

### SET ME 118 AKSESORE

5.590

HKTAC011182



Sasia

118 Copë  
1/4"

### SET UNIVERSAL ME 120 VEGLA PUNE

7.900

HKTAC011201



Sasia

120 Copë

**SET ME 7 VEGLA DORE**

1.590

HKTHP20807



Permban

7 Copë  
Vegla mekanike

**SET ME 7 VEGLA DORE**

1.350

HKTH10807



Permban

7 Copë  
Vegla mekanike

**SET ME 25 VEGLA DORE NE VALIXHE PLASTIKE**

2.690

HKTH10258



Permasa

Max rrotullimeve

230 mm x 22.4 mm  
6.600 / min

**SET ME 11 VEGLA PER ELEKTRICIST**

2.150

HKETS0111



Permban

11 Copë

**SET ME 13 VEGLA RRJETI**

3.050

HKTTTS0131



Seti permban

13 vegla  
Doreze me 2 komponente

**SET ME 9 VEGLA DORE**

2.690

HKTH10809



Seti permban

9 vegla

**SET ME 13 VEGLA PLLAKASHTRUESI**

5.990

HKTTTS1108

**ERE**



Seti permban

13 vegla

**KOMPLET ME 30 MAJA ME GODITJE**

1.450

AKSD68303

**ERE**



Maja

PZ0-1-2-2-3, PH0-1-2-2-3-4, SL3-4-5-6  
T10-15-20-25-27-30-40, H3-4-5-6, S1-2-3  
30 Copë

Sasia



## PINCE UNIVERSALE ELEKTRIKE VDE



Kodi	Permasa	Çmimi
HICP28168	6" / 160 mm	<b>890</b>
HICP28188	7" / 180 mm	<b>990</b>
HICP28208	8" / 200 mm	<b>1.090</b>

## TRONKEZE PROFI ELEKTRIKE VDE



Kodi	Permasa	Çmimi
HIHLDCP28160	6" / 160	<b>990</b>
HIHDCP28188	7" / 180	<b>990</b>

## PRERESE KABULLI ELEKTRIKE VDE 6"

**690**

HICCB28160



Permasa

160 mm  
6"

## ZHVESHESE KABULLI ELEKTRIKE VDE 6"

**690**

HIWSP28160



Permasa

160 mm  
6"

## PINCE ELEKTRIKE VDE ME MAJE TE GJATE



Kodi	Permasa	Çmimi
HILNP28168	160 mm	<b>690</b>
HILNP28208	200 mm	<b>810</b>

## SET ME 3 PINÇA ELEKTRIKE VDE

**2.350**

HIKPS28318



Pince 8, Trokeze 7, Pince me maje te gjate 6

## GERSHERE ELEKTRICISTI VDE

**1.590**

HISS1601



Permasa

160 mm  
6"

## SET ME 16 VEGLA ELEKTRIKE VDE

**8.900**

HKITH1601



Permban

16 Cope

### GERSHERE ELEKTRICISTI INOXI

530

HES0187



Permasa

178 mm  
7"

### GERSHERE ELEKTRICISTI

350

HES02855



Permasa

145 mm  
5.5"

### KAÇAVIDE ELEKTRIKE VDE ME MAJE PETE



Kodi	Permasa	Çmimi
HISD814100	SL4 x 100	<b>190</b>
HISD815125	SL5.5 x 125	<b>230</b>
HISD816150	SL6.5 x 125	<b>300</b>

### KAÇAVIDE ELEKTRIKE VDE PH



Kodi	Permasa	Çmimi
HISD81PH060	PH0 x 60	<b>160</b>
HISD81PH180	PH1 x 80	<b>180</b>
HISD81PH2100	PH2 x 100	<b>270</b>
HISD81PH3150	PH3 x 150	<b>290</b>

### KAÇAVIDE ELEKTRIKE VDE PZ



Kodi	Permasa	Çmimi
HISD81PZ180	PZ1 x 80	<b>230</b>
HISD81PZ2100	PZ2 x 100	<b>280</b>

### KOMPLET 6 KAÇAVIDA ELEKTRIKE VDE

1.250

HKISD0608



Sasia

Doreze me 2 komponente

6 Copë

### SET ME 10 KAÇAVIDA ELEKTRIKE TE KEMBYESHME

1.460

HKISD1008



Permban:

SL2.5, SL3, SL4, SL5.5, SL6.5 x 110 mm,  
PH0 PH1, PH2 x 110 mm

Doreze 2 komponente VDE e kembyeshme, Indikator 140 mm

### SET ME 12 KAÇAVIDA ELEKTRIKE TE KEMBYESHME

2.690

HKISD1201



SL2.0, SL2.5, SL3.0, SL3.5, SL4.0, SL5.5, SL6.5x100

PH0x100 PH1x100 PH2x100

Doreze e kembyeshme, indikator 3.0x70mm

**INDIKATOR ELEKTRIK**

**100**

**HSDT1408**



Permasa

PH2 x 25 mm  
AC 100-500V / 3 x140

**INDIKATOR ELEKTRIK**

**140**

**HSDT1908**



Permasa  
Sasia

PH2 X 50 mm  
AC 100 - 500 V / 4-190

**INDIKATOR ME EKTRAN LCD**

**270**

**HSDT2201**



Tensioni

12-20 V

**DEDEKTOR TENSIONI AC**

**1.190**

**VD10003**



Permasa

12V~1000V-

**TESTUES QARKU MAKINASH**

**E RE**

**350**

**HSDT414501**



Tensioni

6-24 V

**TESTUES QARKU MAKINASH**

**E RE**

**1.450**

**HSDT417508**



Tensioni

DC 1-100V

**SET ME 2 MAJA PH2 X 25MM  
ME NDALUES THELLESIE**

**150**

**SDB91PH213**



Maja  
Sasia

PH2 X 25 mm  
2 Copë

**SET ME 2 MAJA PH2 X 50MM  
ME NDALUES THELLESIE**

**E RE**

**180**

**SDB91PH223**



Sasia  
Kapja

PH2X25mm  
1/4"

- 1
- 2
- 3
- 4
- 5
- 6
- 7
- 8
- 9
- 10



### KOMPLET ME 20 MAJA KAÇAVIDE



Kodi	Permasa	Çmimi
SDB11PH213	PH2 X 25 mm	<b>360</b>
SDB11PZ213	PZ2 X 25 mm	<b>450</b>

### KOMPLET ME 10 MAJA KAÇAVIDE TE GJATA



Kodi	Permasa	Çmimi
SDB11PH223	PH2 X 50 mm	<b>460</b>
SDB11PZ223	PZ2 X 50 mm	<b>320</b>

### KOMPLET ME MAJA KAÇAVIDE TE GJATA ME 2 ANE



Kodi	Permasa	Çmimi
SDB21PH233	PH2 X 50 mm	<b>360</b>
SDB21PH223	PH2 X 50 mm	<b>360</b>

### KOMPLET ME 2 MAJA ME GODITJE PH2

**1.350**

SDBIM11T2563

**ERE**



Maja  
Sasia

PH2 x 25 mm  
2 Copë

### KOMPLET ME 2 MAJA ME GODITJE PH2

**120**

SDBIM71PH250

**ERE**



Maja  
Sasia

PH2 x 50 mm  
2 Copë

### KOMPLET ME 10 MAJA ME GODITJE PH2

**590**

SDBIM11PH223



Maja  
Sasia

PH2 x 50 mm  
10 Copë

### KOMPLET ME MAJA ME GODITJE ME 2 ANË 10 COPË

**690**

SDBIM21PH233



Maja  
Sasia

PH2+PH2 X 65 mm  
10 Copë

### KOMPLET ME 10 MAJA ME GODITJE TE GJATA PH2

**1.550**

SDBIM11PH263



Maja  
Sasia

PH2 x 150 mm  
20 Copë

**KOMPLET ME 10 MAJA ME GODITJE TE GJATA TORX**

1.350

SDBIM11T2563



Maja T25 x 150 mm  
 Sasia 10 Copë

**SET ME 6 ADAPTOR 6-12 MM 1/4"**

790

AMN65061



Permasa 6mm,7mm,8mm,9mm,10mm,12mm  
 Kapja 1/4"

**SET ME 3 ADAPTOR 1/4" 8 MM**

450

AMN0831



Permasa 8 mm  
 Sasia 3 Copë

**SET ME 3 ADAPTOR 1/4" 10 MM**

450

AMN1031



Permasa 10 mm  
 Sasia 3 Copë

**SET ME 3 ADAPTOR 1/4" 12 MM**

490

AMN1231



Permasa 10 mm  
 Sasia 3 Copë

**SET ME 3 ADAPTOR 1/4" 13 MM**

550

AMN1331



Permasa 13 mm  
 Sasia 3 Copë

**SET ME 3 ADAPTORE KRIKETI 1/4", 3/8", 1/2"**

390

AMN365A01



Kapja 1/4", 3/8", 1/2"  
 Sasia 3 cope

**SET ME 9 MAJA KACAVIDASH**

390

AKSD0071



Permasa PH1,PH2,PH3,SL4.0,SL5.5,SL6.5,PZ1,PZ2

### SET ME 2 ADAPTORE MAGNETIK

290

ABH10601



Maja  
Sasia

60 mm  
2 Copë

### SET ME 2 ADAPTORE ME KAPJE TE SHPEJTE

450

ABH20601



Maja  
Sasia

60 mm  
2 Copë

### ADAPTOR MAJASH MAGNETIK

**IRI**

250

ABH30801



Kapja  
Permasa

3 - 1/8"  
60 mm

### ADAPTOR MAJASH MAGNETIK

**IRI**

360

ABH40606



Kapja  
Permasa

2 - 3/8"  
60 mm

### ADAPTOR MAJASH ME LIMITATOR

**IRI**

450

ABH50608



Kapja  
Permasa

2 - 3/8"  
60 mm

### SET HEXAGON 8 COPE

450

HHK14081



Permasa  
Sasia

2-8 mm  
8 Copë

### SET TORX 8 COPE

530

HHK14083



Permasa  
Sasia

T9 - T40  
8 Copë

### SET HEXAGON I GJATE 9 COPE

450

HHK11091



Permasa  
Sasia

1.5-10 mm  
9 Copë



**SET HEXAGON I GJATE ME KOKE SFERIKE 9 COPE**

**590**

HHK12091



Permasa  
Sasia

1.5-10mm  
9 Copë

**SET HEXAGON EXTRA I GJATE 9 COPE**

**670**

HHK11092



Permasa  
Sasia

1.5-10 mm  
9 Copë

**SET HEXAGON EXTRA I GJATE 9 COPE**

**690**

HHK12092



Permasa  
Sasia

1.5-10 mm  
9 Copë

**KOMPLET TORX I GJATE 9 COPE**

**590**

HHK13091



Permasa  
Sasia

T10 - T50  
9 Copë

**SET TORX EXTRA I GJATE 9 COPE**

**690**

HHK13092



Permasa  
Sasia

T10 - T50  
9 Copë

**SET HEXAGON DHE TORX 18 COPE**

**1.250**

HHKSET0181



Permasa  
Sasia

9cp Hex 1.5-10mm / 9 cp Torx T10-T50)  
18 Copë

**TAF HEXAGON 4 X 100 MM**

**130**

HHK1541001

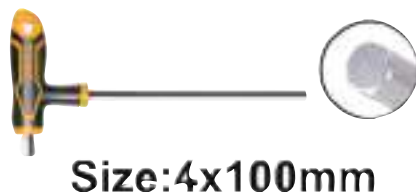

**Size:4x100mm**

Permasa

4 x 100 mm

**TAF HEXAGON 5 X 150 MM**

**160**

HHK1551501

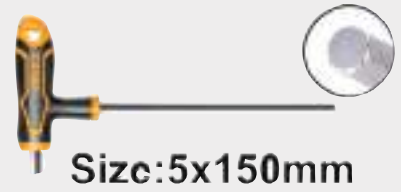

**Size:5x150mm**

Permasa

5 x 150 mm

### SET HEXAGON 8 COPEË

790

HHKT8081



Permasa  
Doreza

8 cope  
Te gomua

### SET TAF - TORX 8 COPEË

1.690

HHKT80838



Permasa

T10X75, T15X75, T20X100, T25X100  
T30X150, T40X150, T45X200, T50X200

### ÇEKIÇ GJERMAN ME BISHT FIBRE



Kodi	Permasa	Çmimi
HMH880100	100 gr	<b>380</b>
HMH880500	500 gr	<b>590</b>

### ÇEKIÇ GJERMAN ME BISHT FIBRE



Kodi	Permasa	Çmimi
HMH881000	1000 gr	<b>790</b>
HMH881500	1500 gr	<b>990</b>

### ÇEKIÇ GJERMAN ME BISHT FIBRE

1.350

HMH882000



Permasa

2000 gr

### ÇEKIÇ GJERMAN ME BISHT FIBRE

290

HMHS81001



Permasa

100 gr

### ÇEKIÇ GJERMAN ME BISHT FIBRE

440

HMHS83001



Permasa

300 gr

### ÇEKIÇ GJERMAN ME BISHT FIBRE

590

HMH8180500



Permasa

500 gr

### ÇEKIÇ GJERMAN ME BISHT FIBRE

**IRI**



Drop forged

Kodi	Permasa	Çmimi
HMH82200	200 gr	<b>360</b>
HMH82300	300 gr	<b>400</b>

### ÇEKIÇ GJERMAN ME BISHT FIBRE

**IRI**



Drop forged

Kodi	Permasa	Çmimi
HMH82500	500 gr	<b>530</b>
HMH821000	1000 gr	<b>890</b>

### ÇEKIÇ ME BISHT DRURI

**390**

HMH040300



Hardwood handle



Drop forged

Permasa

300 gr

### ÇEKIÇ ME BISHT DRURI

**530**

HMH040500



Hardwood handle



Drop forged

Permasa

500 gr

### ÇEKIÇ ME BISHT DRURI

**690**

HMH041000



Hardwood handle



Drop forged

Permasa

1000 gr

### VARRE ME BISHT FIBRE

**790**

HSTHS81000



Drop forged

**SUPER SELECT**

Permasa

1000 gr

### VARE ME BISHT FIBRE

**990**

HSTH8803



Permasa

1500 gr

### VARRE ME BISHT FIBRE

**1.250**

HSTH8804



Permasa

2000 gr



### VARE ME BISHT DRURI



Drop forged

Kodi	Permase	Çmimi
HSTH041000	1000 gr	<b>850</b>
HSTH041500	1500 gr	<b>950</b>
HSTH042000	2000 gr	<b>990</b>

### VARE ME BISHT FIBRE E GJATE



Drop forged

**2.990**

HSTH03498

Pesha

4000 gr

### VARE ME BISHT FIBRE E GJATE



Drop forged

**3.350**

HSTH03598

Pesha

5000 gr

### ÇEKIÇ GOME INDUSTRIAL ME BISHT FIBRE 8 OZ

**350**

HRUH8208

Pesha

220 gr

Veshja

Fiber



Rubber

### ÇEKIÇ GOME INDUSTRIAL ME DOREZE TE GOMUAR 450 GR

**490**

HRUH8216

Pesha

450 gr

Veshje

Gome



Rubber

### ÇEKIÇ GOME DHE PLASTIK ME BISHT FIBRE XHAMI

**790**

HRPH8140

Diametri

40 mm



### ÇEKIÇ GOME PER PLLAKA 2 KG

**990**

HDBM01028

Pesha

2 Kg

Veshje

Fiber



### ÇEKIÇ GOME INDUSTRIAL ME BISHT FIBRE 8 OZ



Natural rubber

Kodi	Permase	Çmimi
HRUH8308	220 gr / 8 OZ	<b>530</b>
HRUH8316	450 gr / 16 OZ	<b>690</b>

### ÇEKIÇ KARPENTIERI ME BISHT FIBRE 8 OZ

280

HRH60028



Pesha

600 gr  
i farketuar

### ÇEKIÇ LLAMARINE ME BISHT FIBRE 8 OZ

790

HCHS8008



Pesha

220 gr

### ÇEKIÇ LLAMARINE ME BISHT FIBRE 8 OZ

450

HCH81008

**IRI**



Pesha

220 gr

### ÇEKIÇ LLAMARINE ME BISHT FIBRE 8 OZ

450

HCH81060

**IRI**



Pesha

600 gr

### ÇEKIÇ KARPENTIERI ME MAGNET ME BISHT FIBRE

890

HIHH80700



Pesha  
Gjatesia

700 g  
360 mm

### KOMPLET ME 7 ÇEKIÇA LLAMARINISTI

5.950

HBAFH0711



Materiali i temperuar  
Sasia

Karbon 45 #  
7 Copë

### LEVE DIZERMIMI



Kodi	Permasa	Çmimi
HWBA01142	14"(350mm)	470
HWBA01242	24"(600mm)	990

### LEVE DIZERMIMI



Kodi	Permasa	Çmimi
HWBA01362	36"(900mm)	1.590
HWBA01482	48"(1200mm)	1.690

**PISTOLETE SILIKONI METALIKE E VERDHE**

**490**

**HCG0909**



Permasa

235 mm  
9"

**PISTOLETE SILIKONI PROFI. ME KORNIZE METALIKE**

**790**

**HCG1709**



Permasa

235 mm  
9"

**PISTOLETE SILIKONI METALIKE E VERDHE**



Unique design

**270**

**HCG1809**



Pesha

9"

**PISTOLETE SILIKONI SALLAM ALUMINI 9"**

**890**

**HCG0109**



Permasa

300 ml  
9"

**PISTOLETE SILIKONI SALLAM ALUMINI 15"**

**1.190**

**HCG0115**



Permasa

600 mm  
15"

**PISTOLETË SILIKONI ME KORNIZE DOPIO SHTYTJE**

**450**

**HCG1409**



Gjatësia  
Diametri

235 mm / 9"  
55 mm

**DALTE BETONI ME GOMINE ME MAJE TE SHESHTE**

**350**

**HCCL082210**



Permasa

250 mm

**DALTE BETONI ME GOMINE ME MAJE TE SHESHTE**

**490**

**HCCL082412**



Permasa

300 mm



### DALTE BETONI ME GOMINE ME MAJE

**45#CS** **4x16x250mm**  
5/32"x5/8"x10"

350

HCC0841016



Permasa

250 mm

### DALTE E SHESHTE ME DOREZE ME 2 KOMPONENTE

**40Cr** **19x16x305mm**  
3/4"x5/8"x12"

630

HCCL851916



Permasa

305 x 19 mm

### DALTE E SHESHTE ME DOREZE ME 2 KOMPONENTE

**40Cr** **25x19x305mm**  
1"x3/4"x12"

690

HCCL852519



Permasa

305 x 25 mm

### DALTE DRURI

**CrV** **6mm(1/4")**

350

HWC0806



Permasa

6 x 140 mm

### DALTE DRURI

**CrV** **9mm(3/8")**

350

HWC0809



Permasa

9 x 140 mm

### DALTE DRURI

**CrV** **12mm(1/2")**

350

HWC0812



Permasa

12 x 140 mm

### DALTE DRURI

**CrV**



Kodi	Permasa	Çmimi
HWC0814	14 x 140 mm	420
HWC0822	22 x 140 mm	420
HWC0825	25 x 140 mm	420

### SET ME 3 DALTA DRURI

**CrV** **3PCS/SET**

990

HKTWCS301



Permasa

12 mm, 19 mm, 25 mm

Gjatesia

140 mm

**LIME HEKURI TREKENDORE**

**390**

**HSTF088P**



Permasa

200 mm

**LIME HEKURI TREKENDORE**

**350**

**HSTF088**



Permasa

200 mm

**LIME HEKURI RRETHORE**

**350**

**HSRF088**

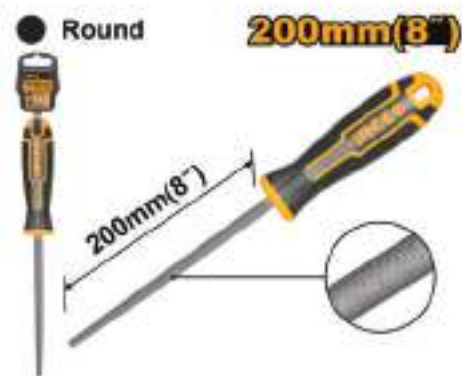

Permasa

200 mm

**LIME HEKURI GJYSEM RRETHORE**

**390**

**HSHF088**

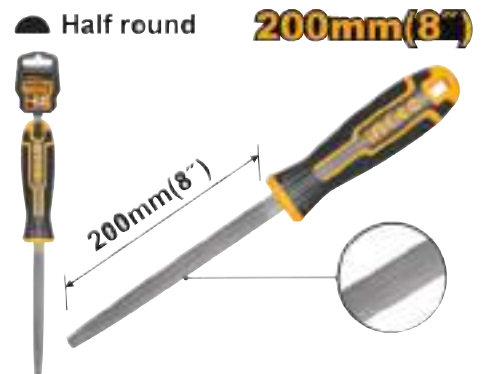

Permasa

200 mm

**LIME HEKURI E SHESHTE**

**420**

**HSFF088**

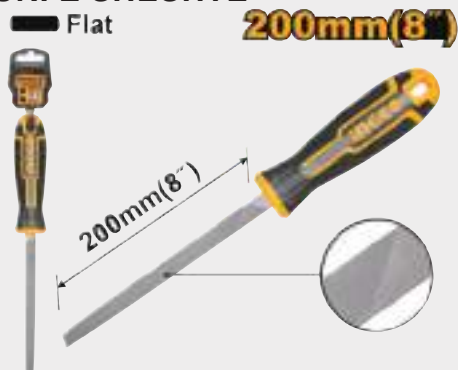

Permasa

200 mm

**SET ME 6 MINI LIMA METALI**

**490**

**HKTF63**



Permasa

140 mm

**THIKE TAPICERIE ME BUTON ME 1 LAME SK5**

**140**

**HKNS16618**



Permasa

100 x 18 mm

**THIKE TAPICERIE ABS E VERDHE**

**150**

**HKNS16518**



Permasa

100 x 18 mm

**THIKE TAPICERIE PROFI  
 ME 3 LAMA SK5**



**290**  
**HKNS16538**

Permasa 18 x 100 mm

**THIKE MULTIFUNKSIONALE XHEPI**



**360**  
**HMFK8108**

Permasa Me 10 funksione 9.5 cm

**THIKE TAPICERIE ME SHINE**



**60**  
**HKNS16001**

Permasa: 18x100 mm  
 Gjatesia 152 mm

**THIKE TAPICERIE ME SHINE**



**90**  
**HKNS110925**

Permasa 9 x 80 mm

**THIKE TAPICERIE ME SHINE**



**150**  
**HKNS11815**

Permasa 100 x 18 mm

**THIKE TAPICERIE ME SHINE SK4**



**290**  
**HKNS112505**

Permasa 127 x 25 mm

**THIKE TAPICERIE ME SHINE**



**120**  
**HKNS11805**

Permasa 100 x 18 mm

**THIKE TAPICERIE ME SHINE**



**100**  
**HRSUK19**

Permasa 61 x 19 mm

- 1
- 2
- 3
- 4
- 5
- 6
- 7
- 8
- 9
- 10



**THIKE TAPICERIE SUPER SELECT ME 3 LAMA**

**180**

**HKNS28035**



Permasa:  
Gjatesia

18 x 100 mm  
152 mm

**THIKE TAPICERIE INOXI PER LAMA**

**50**

**HKNS1806**



Permasa

9 x 18 mm

**SET ME THIKE ALUMINI ME 10 LAMA DHE THIKE TAPICERIE ALUMINI 10 LAMA**

**450**

**HUK180225**



Permasa

61 x 19 mm

**THIKE E ZINGUAR ME LAME SK5**

**390**

**HUK615**



Permasa

61 x 19 mm

**THIKE ME 6 LAMA REZERVE SK5**

**540**

**HUK6128**



Permasa

61 x 19 mm

**THIKE ALUMINI ME 6 LAMA SK5**

**450**

**HKNS1808**



Permasa

100 x 18 mm

**SET ME 10 LAMA REZERVE**

**90**

**HUKB61001**



Permasa

61 x 19 mm

**SET ME 10 LAMA REZERVE**

**70**

**HKNSB112**



Permasa

18 x 100 mm

### THIKE MULTIFUNKSIONALE ME 15 FUNKSIONE

690  
HMFK8158



Me 15 funksione

### ZHVESHESE KABULLI E DREJTE

390  
HPK82101



Permasa

200 mm

### ZHVESHESE KABULLI ME HARK

450  
HPK82001



Gjatesia

200 mm

### SET ME 10 LAMA THIKE

**ERE**

60  
HKNSB0901



Materiali i temperuar

9 x 80 mm

### SET ME 10 LAMA THIKE SK4

270  
HKNSB2501



Permasa  
Sasia

65Mn 450mm(18") 25x127 mm  
9 Copë

### SHARRE ME UDHEZUES KENDESH

890  
HMBSK30082



Permasa:

300 mm  
12"

### SHARRE DORE PER DRU

**ERE** 65Mn  
400mm(16")  
530  
HHAS15400



Permasa

400 mm

### SHARRE DORE PER DRU

**ERE** 65Mn  
450mm(18")  
590  
HHAS15450



Permasa

450 mm

### SHARRE DORE PER DRU

**490**

HHAS08400



Permasa

400 mm

### SHARRE DORE PER DRU

**590**

HHAS08450



Permasa

450 mm

### SHARRE DORE PER DRU

**650**

HHAS08500



Permasa

500 mm

### SHARRE DORE PER DRU

**650**

HHAS08550



Permasa

550 mm

### SHARRE DORE PER DRU DOREZE ME 2 KOMPONENTE

**950**

HHAS28400



Permasa

400 mm

### SHARRE DORE PER DRU DOREZE ME 2 KOMPONENTE

**990**

HHAS28450



Permasa

450 mm

### SHARRE DORE PER DRU DOREZE ME 2 KOMPONENTE



Kodi	Permasa	Çmimi
HHAS28500	500 mm	<b>950</b>
HHAS28550	550 mm	<b>990</b>

### SHARRE DORE PER DRU ME DOREZE PLASTIKE

**350**

HHAS48400



Permasa

400 mm

16"



**SHARRE DORE PER DRU DOREZE ME 2 KOMPONENTE**

**630**

**HMBSB3008**



Permasa: 300 mm  
12"

**SHARRE DORE PER DYSHEME**

**790**

**HMBSB3028**



Permasa: 300 mm  
12"

**SHARRE DORE HEKURI E VERDHE**

**E RE**

**300mm(12")**

**350**

**HHF3058**



Permasa 300 mm

**SHARRE DORE HEKURI E VERDHE**

**300mm(12")**

**350**

**HHF3038**



Permasa 300 mm

**SHARRE DORE HEKURI SUPER SELECT**

**450**

**HHFS3068**



Permasa 300 mm

**SHARRE DORE HEKURI ME TRUP ALUMINI**

**890**

**HHF3008**



Permasa 300 mm  
12"

**SHARRE DORE HEKURI ME DOREZE ME GOMINE**

**470**

**HHF3028**



Permasa 300 mm  
12"

**SHARRE DORE ME TRUP ALUMINI**

**990**

**HHF3088**



Permasa 300 mm  
12"

**SHARRE DORE DRURI KLASIKE**

**890**

**HBS6101**



Lama  
Permasa

610 mm  
24"

**SHARRE DORE ME TRUP ALUMINI**

**450**

**MHHF1503**



Lama  
Permasa

150 mm  
6"

**SHARRE DORE MINI ME LAME**

**180**

**MHHF1501**

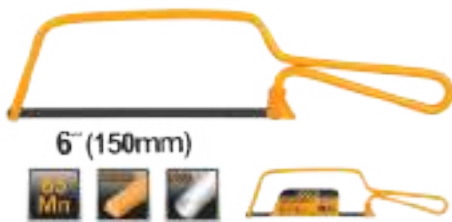

Lama  
Permasa

150 mm  
6"

**SET ME 5 LAMA SHARRE BI-METALI  
300 MM**

**530**

**HSBKT12185**



Dhembe

18T

**SET ME 5 LAMA SHARRE BI-METALI**

**630**

**HSBKT12245**



Permasa  
Dhembe

300 MM  
24 T

**SET ME 10 MINI LAMA HEKURI**

**180**

**MHSB1521**

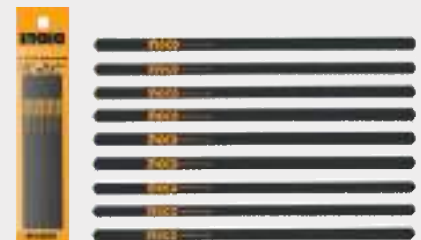

Lama  
Permasa

150 mm  
6"

**SUPER ATAC  
( SET ME PAKETIMI 12 COPE )**

**140**

**HSGU3122**



Sasia

12 cope

**ÇPUESE LEKURE PER VRIMA**

**690**

**HLHP028**



Diametri

2.5mm, 3mm, 3.5mm, 4mm, 4.5mm, 5mm

### SHARRE UNIVERSALE PER DRU DHE GIPS

630

HWBSW68



Permasa

150 mm

### SHARRE GIPSI ME TEH SK5

530

HCS3008



Permasa

300 mm

### SHARRE UNIVERSALE GIPSI

450

HCS30028C



Permasa

300 mm

### ZDRUKTH DORE PER DRU

690

HPL01300



Gjatesia

235 mm

Gjeresi & Thellesi

44 x 2 mm

### THIKE PER ZDRUKTH DRURI

170

HPLB301



Permasa

88 x 44 mm

E pershtatshme per zdrukthin HPL01300

### ZDRUKTH DORE PER GIPS

890

HBP02250



Permasa

250 mm

### LAME REZERVE PER ZDRUKTH DORE GIPSI

220

HPLB2501



Permasa

250 mm

### PRERESE PLLAKASH 600 MM

3.950

HTC04600



Gjeresia e prerjes

600 mm



### PRERESE PLLAKASH 800 MM

8.500

HTC04800AG



Gjeresia prerjes

800 mm

### RRUL PER PRERESE PLLAKASH 600 MM

330

HTC04600B



Suitable for  
HTC04600

Permasa

Per prerese Pllakash

16 x 6 x 3 mm

HTC04600

### RRUL PER PRERESE PLLAKASH 800 MM

790

HTC04800B



Permasa

Per prerese Pllakash

22x10.5x2mm

HTC04800AG

### SKRAPELLO

**IRI**

450

HGS3201



Permasa

310 mm

### PERÇINUESE DORE 10.5"

530

HRS108



Permasa

Per perçina alumini

2.4 mm, 3.2 mm, 4 mm, 4.8 mm

10.5"

### PERÇINUESE DORE 10"

690

HR101



Permasa

Per perçina

2.4 mm, 3.2 mm, 4 mm, 4.8 mm

260 mm, 10"

### PERÇINUESE DORE 10.5" TRUP ALUMINI

690

HR105



Permasa

Per perçina

2,4 mm, 3.2 mm, 4.0 mm, 4.8 mm

10.5"

### PERÇINUESE ME KOKE TE RROTULLUESHME 360° TRUP ALUMINI

1.450

SHHR106



Permasa

Per perçina

2.4 mm, 3.2 mm, 4.0 mm, 4.8 mm

10.5"

### PERÇINUESE PER PERÇINA INOXI 8" DHE ALUMINI

1.450

HR081



Per perçina inoxi 2.4 mm, 3.2 mm, 4.0 mm  
 Per perçina alumini 2.4 mm, 3.2 mm, 4.0 mm, 4.8 mm

### PERÇINUESE DORE FIZARMONIKE 32"

2.690

HFOR321



Permasa 815 mm, 32"  
 Per perçina 3.2 mm, 4 mm, 4.8 mm, 6 mm, 6.4 mm

### PERÇINUESE DORE E GJATE ME DOREZE PLASTIKE

1.690

HR131



Permasa 13"  
 Per perçina alumini 3.2 - 6.4 mm

### ELMAZ XHAMI ME BISHT DRURI

230

HGCT02



Permasa 134 mm

### ELMAZ XHAMI ME BISHT METALIK

450

HGTC03



Permasa 178 mm

### KOMPAST PER PRERJE XHAMI

990

HGCT16001



Diametri i prerjes 600 mm

### VENTUZE TEKE PER NGRITJE

530

HSU012501



Pesha mbajtese 25 kg

### VENTUZE DOPIO PER NGRITJE

990

HSU025001



Pesha mbajtese 50 kg

### PRERESE TELI HIDRAULIKE

7.690

HHSC0112



Kapaciteti shtrengimit  
Forca shtrengimit

$\phi 4 - \phi 12\text{mm}$   
45 KN

### SET THIKE PER PRERESE TELI PER HHSC0112

890

HHSC0112B



Diametri prerjes  
Materiali

4 - 12 mm  
CR12MOV

### PRERESE TELI HIDRAULIKE

11.500

HHSC0122



Kapaciteti shtrengimit  
Forca shtrengimit  
Foleja

$\phi 4 - \phi 22\text{mm}$   
100 KN  
24 mm

### THIKE PER PRERESE TELI PER HHSC0122

1.350

HHSC0122B



Diametri prerjes  
Materiali

4 - 22 mm  
CR12MOV

### PRESE HIDRAULIKE MANUALE PER KAPIKORDA

7.690

HHCT01240



Kapaciteti shtrengimit  
Forca shtrengimit  
Foleja

Cu 16-240mm<sup>2</sup>  
70 KN  
18 mm

### PRESE PER KAPIKORDA ELEKTRIKE

6.690

HHCT0170



Permasa

4 - 70 mm

### PINCE KAPIKORDASH TERMINALI TE ZHVESHURA

1.290

HRCPC0506



Kapaciteti shtrengues  
Gjatesia  
Per kapikorda te zhveshura

0.5 - 6 mm<sup>2</sup>  
9"

### PINCE TERMINALI KAPIKORDASH TE VESHURA

1.690

HRCPG05210



Kapaciteti shtrengues  
Gjatesia  
Per kapikorda te veshura

0.25 - 10 mm<sup>2</sup>  
6"



### IZOLANT ELEKTRIK I ZI 0.13 MM



Kodi	Permasa	Çmimi
HPET1103	9.15 m x 0.18 mm x 0.13	<b>50</b>

### IZOLANT ELEKTRIK I ZI 0.19 MM



Kodi	Permasa	Çmimi
HPET1101	9.15 m x 0.18 mm x 0.19	<b>60</b>

### IZOLANT ELEKTRIK BLU 0.13 MM



Kodi	Permasa	Çmimi
HPET1010	20 m x 0.18 mm x 0.13	<b>90</b>

### IZOLANT ELEKTRIK I KUQ 0.13 MM



Kodi	Permasa	Çmimi
HPET1112	20 m x 0.18 mm x 0.13	<b>90</b>

### SET ME 10 IZOLANTE



Kodi	Permasa	Çmimi
HPET1013	20 m x 0.18 mm x 0.13	<b>890</b>

### BATERI ALKALINE 1.5 V AAA



Kodi	Permasa	Çmimi
HAB3A01	AAA	<b>40</b>

### BATERI ALKALINE 1.5 V AA



Kodi	Permasa	Çmimi
HAB2A01	AA	<b>40</b>

### FASHETA PLASTIKE TE BARDHA PAKETIM 100 COPË



Kodi	Permasa	Çmimi
HCT2001	3.6 x 200 mm	<b>220</b>
HCT8001	9.0 x 800 mm	<b>990</b>
HCT10201	9.0 x 1020 mm	<b>990</b>

### FURÇE BOJE VAJI ME BISHT PLASTIK



Kodi	Permasa	Çmimi
CHPTB68701	10 x 40 mm / 1"	<b>70</b>
CHPTB68715	11 x 51 mm / 1.5"	<b>90</b>

### FURÇE BOJE VAJI ME BISHT PLASTIK



Kodi	Permasa	Çmimi
CHPTB68702	11 x 51 mm / 2"	<b>150</b>
CHPTB68703	12 x 57 mm / 3"	<b>280</b>
CHPTB68704	14 x 57 mm / 4"	<b>340</b>

### FURÇE BOJE ME DOREZE ME 2 KOMPONENTE



Kodi	Permasa	Çmimi
CHPTB8701	16 x 25 mm / 1"	<b>190</b>
CHPTB8715	18 x 38 mm / 1.5"	<b>240</b>

### FURÇE BOJE ME DOREZE ME 2 KOMPONENTE



Kodi	Permasa	Çmimi
CHPTB8702	18 x 50 mm / 2"	<b>360</b>
CHPTB8725	20 x 63 mm / 2.5"	<b>450</b>

### FURÇE BOJE VAJI ME DOREZE ME 2 KOMPONENTE



Kodi	Permasa	Çmimi
CHPTB8703	22 x 75 mm / 3"	<b>580</b>
CHPTB8704	22 x 100 mm / 4"	<b>720</b>

### FURÇE BOJE VAJI ME DOREZE ME 2 KOMPONENTE



Kodi	Permasa	Çmimi
CHPTB8601	25 x 8 mm / 1"	<b>100</b>
CHPTB8615	38 x 9 mm / 1.5"	<b>180</b>

### FURÇE BOJE VAJI ME DOREZE ME 2 KOMPONENTE



Kodi	Permasa	Çmimi
CHPTB8602	50 x 10 mm / 2"	<b>190</b>
CHPTB8625	63 x 10 mm / 2.5"	<b>320</b>

### FURÇE BOJE VAJI ME DOREZE ME 2 KOMPONENTE



Kodi	Permasa	Çmimi
CHPTB8603	75 x 10 mm (3")	<b>350</b>
CHPTB8604	100 x 12 mm (4")	<b>430</b>

### SET ME 5 FURCA BOJE VAJI



630

CHPTB8660501



Permasa

2x1", 1x1.5"x2x2"

### FURÇE BOJE VAJI DOREZE ME 2 KOMPONENTE



Kodi	Permasa	Çmimi
HCLB100308	100 x 30 mm / 4"	800
HCLB120308	120 x 30 mm / 5"	990

### RRUL BOJE MICROFIBER DOREZE ME 2 KOMPONENTE

350

HRHT042301D



Permasa

230 mm  
9"

### RRUL BOJE MICROFIBER DOREZE ME 2 KOMPONENTE

530

HRHT042302D

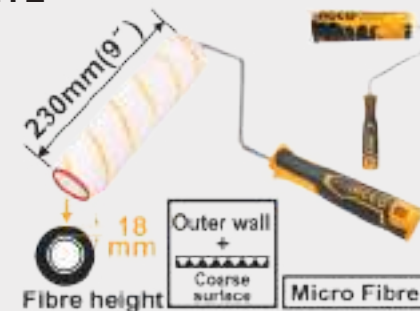

Permasa

230 mm  
9"

### RRUL BOJE ACRYLIC DOREZE ME 2 KOMPONENTE

530

HRHT092551



Permasa

255 mm  
10"

### RRUL BOJE (AKRILIK) DOREZE ME 2 KOMPONENTE

350

HRHT052301



Permasa

230 mm  
9"

### RRUL BOJE MICROFIBER MINI

190

HRHT061001D

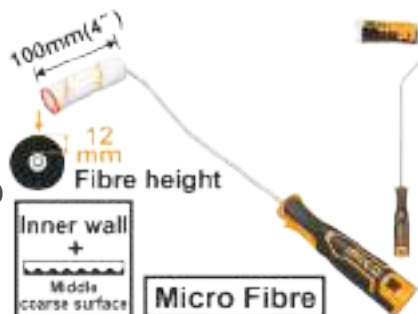

Permasa

100 mm  
4"

### RRUL BOJE MICROFIBER ME BISHT TELESKOPIK

790

HRHT442302T



Permasa

230 mm  
9"



### RRUL BOJE KENDESH / QELESHE MIKROFIBEL



Kodi	Permasa	Çmimi
HRHT360501C	Rrul - 50 mm 2"	<b>270</b>
HRC3305008	Qeleshe - 50 mm 2"	<b>90</b>

### BISHT RRULI TELESKOPIK ALUMINI

**790**

HRCEP0205



Gjatesia

200 cm

### QELESHE MIKROFIBER (PER MURE TE BRENDSHME)



Kodi	Permasa	Çmimi
HRC3610012	100 mm 4"	<b>60</b>
HRC3610016	100 mm 4"	<b>60</b>

### QELESHE MIKROFIBER (PER MURE TE JASHTME)



**180**

HRC323018



Permasa

230 mm  
9"

### QELESHE MIKROFIBER (PER MURE TE JASHTME)

**270**

HRC0925522



Permasa

255 mm  
10"

### QELESHE MIKROFIBER AKRILIK

**170**

HRC0523007



Permasa

230 mm  
9"

### SET 6 NE 1 SKAF + RRULA BOJE MIKROFIBER

**350**

HKTCB061004



Permasa

100 mm / 4 "

### SET SKAF BOJE + 2 RRULA 4 NE 1



**890**

HKTCB042306



Permasa

435x300x7.5mm

**RRUL BOJE MINI MICROFIBER 100 MM**

**120**

**HRHT281002**



Super Select

**RRUL BOJE ACRYLIC DOREZE ME 2 KOMPONENTE**

**990**

**HRHT093051**



Permasa:

305 mm  
12"

**RRUL BOJE MIKROFIBER 230 MM**



Kodi	Permasa	Çmimi
HRHT042301	Rrul boje	<b>390</b>

**RRUL BOJE (AKRILIK)**

**IRI**

**270**

**HRHT282302**



Permasa:

230 mm  
9"

**RRUL BOJE MIKROFIBER**

**IRI**

**90**

**HRC3323012**



Permasa

230 mm  
9"

**SET ME 12 RULA BOJE MIKROFIBER**

**IRI**

**320**

**HRC560412**



Permasa

12 x 100 mm

**SET ME 3 RULA BOJE MIKROFIBER**

**290**

**HRC56091203**



**SKAF BOJE**

**650**

**CHPTT082551**



Lama

300 mm  
12"

### FURCE BOJE VAJI ME BISHT PLASTIK



Kodi	Permasa	Çmimi
CHPTB78601	(1") 40 mm x 10 mm	<b>40</b>
CHPTB78615	(1.5") 41 mm x 10 mm	<b>50</b>

### FURCE BOJE VAJI ME BISHT PLASTIK



Kodi	Permasa	Çmimi
CHPTB78602	(2") 45 mm x 11 mm	<b>70</b>
CHPTB78625	(2.5") 42 mm x 10 mm	<b>90</b>
CHPTB78603	(3") 51 mm x 12 mm	<b>150</b>

### FURCE BOJE VAJI ME BISHT DRURI



Kodi	Permasa	Çmimi
CHPTB0101	(1") 44 mm x 12.5 mm	<b>70</b>
CHPTB0115	(1.5") 44 mm x 13.5 mm	<b>90</b>
CHPTB0102	(2") 51 mm x 14.5 mm	<b>140</b>

### FURCE BOJE VAJI ME BISHT DRURI



Kodi	Permasa	Çmimi
CHPTB0125	(2.5") 51 mm x 15.5 mm	<b>160</b>
CHPTB0103	(3") 57 mm x 116 mm	<b>250</b>
CHPTB0104	(4") 57 mm x 17.5 mm	<b>360</b>

### SET 9 ME FURCA BOJE VAJI ME BISHT DRURI

**990**

CHPTB0114091



Permban 3cp -1", 2cp - 1.5", 2cp - 2", 1cp - 3", 1cp - 4"

### SET ME 3 FURCA BOJE VAJI ME BISHT PLASTIK

**270**

CHPTB7860301



Permasa 1.3"

### SET 12 NE 1 ME RRULA BOJE

**790**

HKTCB121001



Permasa 100 mm / 4 "

### SET SKAF DHE RRUL BOJE

**990**

HKTCB032301



Permasa 435x300x7.5mm



### SET SKAF DHE RRUL BOJE

1.450

HKTCB83230083



Permasa

435x300x7.5mm

### BERDAF PER BOJAK SFUNGJER /GOME



Kodi	Permasa	Çmimi
HSFR24008	230 mm x 100 mm	<b>630</b>
HSFR24108	240 mm x 100 mm	<b>690</b>

### MALLO INOX ME DOREZE ME 2 KOMPONENTE

**ERE**

790

HPT28138



Permasa

280 x 130 mm

### MALLO INOX ME DHEMBE DOREZE ME 2 KOMPONENTE

280x130mm



Kodi	Permasa	Çmimi
HPTT28138S	280 x 130 mm	<b>690</b>
HPTT28138	280 x 130 mm	<b>690</b>

### MALLO ME DOREZE PLASTIKE



Kodi	Permasa	Çmimi
HPT23108	230x100mm	<b>190</b>
HPT231025	230x125mm	<b>190</b>

### MISTRI E RRUMBULLAKET DOREZE ME 2 KOMPONENTE



Kodi	Permasa	Çmimi
HBT738	180 mm	<b>390</b>
HBT828	200 mm	<b>390</b>

### MISTRI E RRUBULLAKET ME DOREZE PLASTIKE

**IRI**



Kodi	Permasa	Çmimi
HBT7125	7" / 180 mm	<b>270</b>
HBT8125	8" / 200 mm	<b>290</b>

### MISTRI 7" ME MAJE KATRORE ME DOREZE ME 2 KOMPONENTE

**IRI**

360

HBT748

180mm(7")



Lama

180 mm  
7"

### MALLO PATINIMI ME DOREZE GOME

1.350

HPTM40801



Permasa

400mm x 80mm

### SHPATULL PATINIMI ME DOREZE ME 2 KOMPONENTE



Kodi	Permasa	Çmimi
HPUT18060	60 mm	<b>300</b>
HPUT18080	80 mm	<b>340</b>

### SHPATULL PATINIMI ME DOREZE ME 2 KOMPONENTE



Kodi	Permasa	Çmimi
HPUT18100	100 mm	<b>360</b>
HPUT18150	150 mm	<b>450</b>

### SHPATULL PATINIMI ME BISHT PLASTIK



Kodi	Permasa	Çmimi
HPUT686050	50 mm	<b>90</b>
HPUT686063	63 mm	<b>100</b>
HPUT686100	100 mm	<b>120</b>

### SHPATULL ME DOREZE ME 2 KOMPONENTE



Kodi	Permasa	Çmimi
HPUT08040	40 mm	<b>220</b>
HPUT08060	60 mm	<b>230</b>
HPUT08080	80 mm	<b>250</b>

### SHPATULL ME DOREZE ME 2 KOMPONENTE



Kodi	Permasa	Çmimi
HPUT08100	100 mm	<b>270</b>
HPUT08125	125 mm	<b>320</b>

### SHPATULL E GJERE ME DOREZE PLASTIKE



Kodi	Permasa	Çmimi
HPUT20011	200 mm	<b>270</b>
HPUT25011	250 mm	<b>350</b>

### SHPATULL ME DOREZE ME KEND TE GOMUAR ME 2 KOMPONENTE

450

HPUT78200



Permasa

200 mm

### SET KOVE ME BERDAF



Kodi	Permasa	Çmimi
00250	10 Lt, 42x22x18 cm	<b>3.500</b>

### TRIPOD ALUMINI ME ZGJATIM



83280

Kodi	Lartesia	Çmimi
18020	0.5-1.5 m	<b>3.500</b>

### PISTOLETE SHKUME PLASTIKE E SHKURTER



Kodi	Materiali	Çmimi
09171	Plastike	<b>690</b>

### PISTOLETE SILIKONI SALLAM

**BORMANN**  
PRO



Kodi	Kapaciteti	Çmimi
BHT1510	600cc	<b>1.690</b>

### SET ME 12 LAPSA KARPENTIERI



Kodi	Ngjyra	Çmimi
09180	Te kuq 180 mm	<b>290</b>

### LEVE GOZHDESH

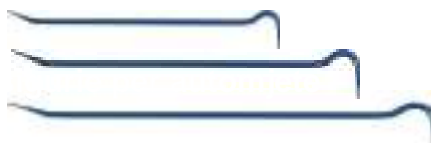

Kodi	Madhesia	Çmimi
34600	600 mm	<b>520</b>
34750	750 mm	<b>590</b>
34900	900 mm	<b>690</b>

### PISTOLETE SHKUME METALIKE E SHKURTER



Kodi	Materiali	Çmimi
09172	Metalike	<b>1.250</b>

### PISTOLETE SILIKONI PROFESIONALE

**BORMANN**  
PRO



Kodi	Kapaciteti	Çmimi
BHT1517	300 ml	<b>1.390</b>

### LITAR MURATORI



Kodi	Diam/Gjatesia	Çmimi
17473	2.0 mm / 50m	<b>290</b>

### PISTOLETE SILIKONI 230 MM



Kodi	Dimensioni	Çmimi
09100	230 mm	<b>350</b>

### PISTOLETE SHKUME ME MAJE TE GJATE



Kodi	Dimensioni	Çmimi
09165	500 mm	<b>1.890</b>

### PISTOLETE SHKUME

**BORMANN**  
PRO



Kodi	Permasa	Çmimi
BHT1520	55-110 mm	<b>1.890</b>



**VENTUZE TEKE  
1X115 MM**

Kodi	Kapaciteti	Çmimi
05300	40 kg	<b>650</b>

**VENTUZE DOPIO  
2X115 MM**

Kodi	Kapaciteti	Çmimi
05301	70 kg	<b>1.190</b>

**VENTUZE TRESHE  
3X115 MM**

Kodi	Kapaciteti	Çmimi
05302	100 kg	<b>1.590</b>

**VENTUZE DOPIO PROFE-  
SIONALE 2X115 MM**

Kodi	Kapaciteti	Çmimi
05312	70 kg	<b>2.150</b>

**MISTRI KENDESH  
80X60X60 MM**

Kodi	Permase	Çmimi
06150	80x60x60 mm	<b>390</b>

**TUB NIVELI 8MM 1/2"**

Kodi	Gjatesia	Çmimi
16001	20 m	<b>1.590</b>

**PLUMCE**

Kodi	Kapaciteti	Çmimi
17303	6m, 200 gr	<b>550</b>
17304	4.5m 300 gr	<b>570</b>

**SPANGO ME BOJE BLU  
115 GR**

Kodi	Gjatesia	Çmimi
17505	15m	<b>290</b>

**NIVELUES ME LAZER ME  
3 VIJA**

Kodi	Largesia	Çmimi
18001	30 m 90°	<b>4.990</b>

**VIZORE PER LOKALIZIM  
KENDESH**

Kodi	Kapaciteti	Çmimi
18180	200 mm	<b>1.490</b>

**SKUADER PER KENDE**

Kodi	Gjatesia	Çmimi
18350	350 m	<b>220</b>

**VIZORE ALUMINI PER  
KENDE**

Kodi	Madhesia	Çmimi
18355	400 mm	<b>1.150</b>
18356	600 mm	<b>1.250</b>
18357	1000 mm	<b>1.290</b>

**VIZORE GIPSI T**

Kodi	Permasa	Çmimi
18372	T1200x390mm	<b>1.790</b>
18375	T1200x320mm	<b>2.390</b>

**TEFLON**

Kodi	Permasa	Çmimi
75201	12x12x0.1 mm	<b>75</b>

**MBROJTESE GJUNJESH EPE+PE**

Kodi	Çmimi
74601	<b>950</b>

**TORCE ME BOMBULA BUTANI**

Kodi	Çmimi
73400	<b>2.500</b>

**VIZORE ALUMINI KENDESH**

Kodi	Permasa	Çmimi
18377	180x180x250mm	<b>690</b>
18530	180mm	<b>220</b>

**CEKIC KARPENTIERI ME BISHT KARBONI**

Kodi	Pesha	Çmimi
32685	600 gr	<b>950</b>

**MBROJTESE GJUNJESH EVA**

Kodi	Çmimi
74624	<b>590</b>

**BOMBUL GAZI**

Kodi	Çmimi
FB20	<b>950</b>

**SET ME 6 MINI DALTA DRURI**

Kodi	Sasia	Çmimi
25700	6 cope	<b>490</b>

**KOMPAST PER PRERJE GIPSI 30-400 MM**

Kodi	Diametri	Çmimi
03990	30-400 mm	<b>990</b>

**SFUNGJER HIDROFILIK**

Kodi	Permasa	Çmimi
04542	170x110x60 mm	<b>390</b>

**TORCE SALDIMI BOMBUL BUTANI**

Kodi	Pershkrimi	Çmimi
FT30	Pa çentil	<b>1.990</b>
FT35	Me çentil	<b>2.490</b>

## BTC2000 / 2200 / 2500

### PRERESE PLLAKASH

Pret një sërë pllakash muri dhe dyshemeje. Prej çeliku te kromuar ofrojnë punë të qetë, ndërsa shufra e prerjes siguron prerje të pastra dhe të sheshta. Ky prerës përfshin gjithashtu një udhëzues të rregullueshëm të prerjes anësore të krijuar për të bërë prerjet e përsëritura në pllakë më shpejt dhe më të lehtë.

Bazë alumini për qëndrueshmëri dhe peshë të lehtë

Kapaciteti prerës ( 0 - 45 ) 6 30 / 445mm

Rregullimi i lartësisë së prerjes

Prerja e diskut me kushineta.

Përfshin një disk prerje



Kodi	BTC2000	BTC2200	BTC2500
<b>Kendi 0</b>	630 mm	750 mm	950 mm
<b>Kendi 45</b>	445 mm	525mm	670 mm
<b>Pesha</b>	9.5 kg	10.5 kg	
<b>Cmimi</b>	<b>14.900</b>	<b>21.500</b>	<b>25.900</b>

## BTC3000 / 2500

### PRERESE PLLAKASH

Pret një sërë pllakash muri dhe dyshemeje. Prej Çeliku te kromuar ofrojnë punë të qetë, ndërsa shufra e prerjes siguron prerje të pastra dhe të sheshta. Ky prerës përfshin gjithashtu një udhëzues të rregullueshëm të prerjes anësore të krijuar për të bërë prerjet e përsëritura në pllakë më shpejt dhe më të lehtë.

Bazë alumini për qëndrueshmëri dhe peshë të lehtë

Rregullimi i lartësisë së prerjes

Prerja e diskut me kushineta.

Përfshin një disk prerje

Mbështetje majtas dhe djathtas me krahë të palosshëm



Kodi	BTC3000	BTC3250
<b>Kendi 0</b>	1290 mm	1520 mm
<b>Kendi 45</b>	900 m	1020 mm
<b>Pesha</b>	20.2 kg	22 kg
<b>Cmimi</b>	<b>38.900</b>	<b>43.500</b>



### Rrul per prerese pllakash

Kodi	BTC202
<b>Per prerese</b>	per BTC2000, 2200, 2500, 3000 & 3250
<b>Cmimi</b>	<b>1.450</b>

### Doreze per prerese pllakash

Kodi	BTC005
<b>Per prerese</b>	per BTC2000, 2200, 2500
<b>Cmimi</b>	<b>2.900</b>

### Vizore per prerese pllakash

Kodi	Per prerese	Cmimi
<b>BTC001</b>	per BTC2000	<b>2.900</b>
<b>BTC002</b>	per BTC2200	<b>4.200</b>



**VINC ELEKTRIK 1050 W**

**19.900**  
**BPA6000**



Fuqia 1050 W  
Kapaciteti 600 kg  
Kavo 18 m

**VINC ELEKTRIK 1600 W**

**52.900**  
**BPA1118**



Fuqia 1600 W  
Kapaciteti 1000 kg  
Kavo 18 m

**KRAH VINCI 75 CM / 600 KG**

**5.990**  
**BPP6000**



**KRAH VINCI 75 CM / 1 TON**

**7.990**  
**BPP1010**



**KARRELE ALUMINI  
E PALOSSHME**

**5.250**  
**BWR9001**



Kapaciteti 90 kg  
e palosshme

**KARRELEME 4 RROTA ME PLATFORME**

**12.900**  
**BWB3500**



Kapaciteti 250 kg  
Me 4 rrota

**KARRELE ME ZGJATUES**

**10.500**  
**BWB3000**



Kapaciteti 250 kg  
Me rrota

**KARRELE METALIKE  
E KUQE**

**5.990**  
**KMK250**



Kapaciteti 250 kg  
E kuqe

**PISTOLETE BOJE ELEKTRIKE**

**35.900**

**BAP7000**

Fuqia  
Rrjedhja  
Presioni  
Gjatesia e tubit



1010 W  
1.5 Lt/min  
206 bar  
10 m

**ZMERILUESE MURI ME MOTOR  
PA KARBONCINA**

**32.900**

**BDS7100**

Fuqia  
Disku  
Nr rrotullimeve  
Lartesia



400 W  
225 mm  
900 - 2100 rpm  
130-210 mm

**NDRICUES LED ME BATERI**

**2.890**

**BPR5000**

Fuqia  
Ndricimi  
Bateri



30 W  
500 Lumen  
e rikarikueshme

**ELEKTRIK ME DRITE LED**

**3.990**

**BPR6025**

Bateria  
Voltazhi karikimit



3.7V  
2600 mAh

**LLAMPE KOKE E KARIKUESHME**

**4.990**

**BPR6065**

Bateria  
Ndricimi  
Mbrojtja nga uji



Lion  
800/250 Lm  
Standarti IP54

**PRERESE PARKETI ME 2 TEHE**

**22.500**

**BPR6025**

Gjatesia  
Preerja  
Kendi



330 mm  
15 mm  
45-90 grade

**METER DISTANCE ME LASER**

**8.900**

**BDM6500**

Largesia  
Klasi i laserit  
Saktesia



60 m  
Klasi 2  
±2mm

**NIVELUES KRYQ ME LASER**

**8.900**

**BDM6800**

Largesia  
Drite  
Saktesia

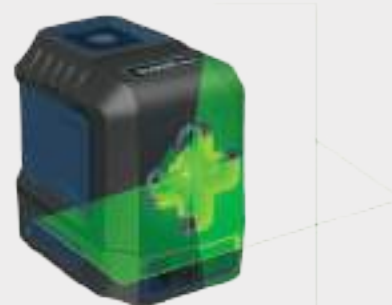

30 m  
Jeshile  
± 3

**SET NIVELUES ME LAZER RROTATIV**



**300m**

**55.900**

**HLRL30051**



Lazer

Jeshil

Me lavjerres deri ne 300 m  
Me receptor dhe pult komandimi

**SET NIVELUES ME LAZER 3D JESHIL**



3Dx360°

**30m**

**28.500**

**HLL255245**



Bateri

4 Ah

Largesia

0 - 30 m

Karikues, syze, adaptor, suport 3D, valixhe plastike

**SET NIVELUES ME LAZER 3D JESHIL**



3Dx360°

**30m**

**18.500**

**HLL255267**



Bateri

5 AH

Karikues, syze, adaptor, suport 3D  
pjate hekuri, valixhe plastike, pult komandimi

**NIVELUES ME LAZER HORIZONTAL**



**15m**

**5.500**

**HLL156508**



Largesia

0-15 m

Me 2 vija

**NIVELUES ME LAZER ME 5 VIJA I KUQ**



**30m**

**11.900**

**HLL306505**



Largesia

0-30 m

Vija te kuqe

1 horizontale / 4 vertikale

**NIVELUES ME LAZER ME 5 VIJA JESHIL**



**30m**

**19.500**

**HLL305205**



Largesia

0-30 m

Vija jeshile

1 horizontale / 4 vertikale

**MATES LARGESIE ME LAZER**



**0.05-60m**

**6.500**

**HLDD0608**



Largesia

0.05-60 m

Saktesia

± 2.0 mm

**MATES LARGESIE ME METER RROTE DIGITAL**



**0-99999.9m**

**4.950**

**HDMW23**

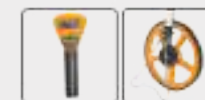

Matja

0.1 - 100 m

Ekrani

Dixhital



### TRIPOD ALUMINI PER NIVELUES ME LAZER

2.990

HLLT01152

Kapja  
Permasa



### TERMOMETER INFRARED

1.690

HIT015501

Temperatura  
Ekran me ngjyra



-30°C~550°C

### TERMOMETER INFRARED

900

HIT010381

Temperatura  
Ekran me ngjyra



32 ° C ~ 42.9 ° C

### ICE ELEKTRONIKE DIXHITALE AC/DC

990

DM6011

Voltazhi AC/DC  
Rezistenca



0.8~600V  
600 kΩ

### ICE ELEKTRONIKE AC/DC

1.350

DM2002

Voltazhi AC  
Voltazhi DC  
Rezistenca



20V/200V/600V  
200mV/2V/20V/200V/600V  
600Ω/6kΩ/60kΩ/600kΩ/6MΩ/60MΩ

### ICE ELEKTRONIKE AC/DC

1.690

DM200

Voltazhi AC  
Voltazhi DC  
Rezistenca



200V/600V  
200mV/2V/20V/200V/600V  
200Ω/2kΩ/20kΩ/200kΩ/2MΩ/20MΩ

### ICE ELEKTRONIKE AC/DC

4.250

DM7502

Voltazhi AC  
Voltazhi DC  
Rezistenca



6V/60V±(0.8%+3) 600V/750V±(1.0%+10)  
600mV/6V/60V/600V/1000V ±(0.5% +3)  
600Ω/6kΩ/60kΩ/600kΩ/6MΩ ±(0.8% +3)

### ICE ELEKTRONIKE AC/DC ME CANTE

4.690

DM6001

Voltazhi AC  
Voltazhi DC  
Rezistenca



60mV/600mV/6V/60V/600V/600V  
60mV/600mV/6V/60V/600V/600V  
600Ω/6kΩ/60kΩ/600kΩ/6MΩ/60MΩ

### PINCE TESTER 200 A

2.350

DCM2001



Voltazhi AC 2V/20V/200V/600V  $\pm(1.0\% +5)$   
 Voltazhi DC 200mV/2V/20V/200V/600V  $\pm(0.5\% +5)$   
 Rezistenca 200 $\Omega$ /2k $\Omega$ /20k $\Omega$ /200k $\Omega$ /2M $\Omega$ /20M $\Omega$   $\pm(1.0\% +3)$

### PINCE TESTER 600 A

2.490

DCM6003



Voltazhi AC 4V/40V/400V/600V  
 Voltazhi DC 400mV/4V/40V/400V/600V  
 Rezistenca 400 $\Omega$ /4k $\Omega$ /40k $\Omega$ /400k $\Omega$ /4M $\Omega$ /40M $\Omega$

### PINCE TESTER DIXHITALE AUTOMATIKE

7.690

DCM100015



Voltazhi AC 60mV/600mV/6V/60V/600V  $\pm(0.8\% +3)$  750V  
 Voltazhi DC 60mV/600mV/6V/60V/600V  $\pm(0.7\% +3)$  1000V  
 Rezistenca 600 $\Omega$ /6k $\Omega$ /60k $\Omega$ /600k $\Omega$ /6M $\Omega$   $\pm(0.8\% +3)$  60M $\Omega$

### SET KABUJSH TESTIMI PER MULTIMETER

470

TL1431



Gjatesia 1.2 m  
 Gjatesia kontaktit 143 mm

### SET KABUJSH TESTIMI

990

TL31432



Gjatesia 1.0 m  
 Gjatesia e kontaktit 143 mm

### ELEKTRIK DORE LED

180

HFL013AAA1



Ndricimi 250 Lumens

### NIVELUES MINI MAGNET ME 3 NIVELE

270

HMSL01030



Permasa 22.5 cm  
 Nivele 3

### NIVELUES MINI ME MAGNET

790

HMSL03101



Gjatesia 10 cm  
 Trashesia 1.5 mm

### NIVELUES ALUMINI DIXHITAL I FREZUAR

4.990

HSL08060D



Gjatesia

60 cm  
Me 3 magnetete

### NIVELUES ALUMINI SUPER SELECT



Kodi	Permasa	Çmimi
HSL58040	40 cm / 2 tregues	<b>350</b>
HSL58060	60 cm / 2 tregues	<b>490</b>
HSL58100	100 cm / 2 tregues	<b>750</b>

### NIVELUES ALUMINI



Kodi	Permasa	Çmimi
HSL18040	40 cm / 3 tregues	<b>450</b>

### NIVELUES ALUMINI



Kodi	Permasa	Çmimi
HSL18060	60 cm / 3 tregues	<b>580</b>

### NIVELUES ALUMINI

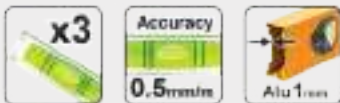

Kodi	Permasa	Çmimi
HSL18080	80 cm / 3 tregues	<b>690</b>

### NIVELUES ALUMINI

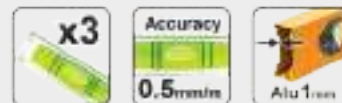

Kodi	Permasa	Çmimi
HSL18100	100 cm / 3 tregues	<b>890</b>

### NIVELUES ALUMINI I FREZUAR



Kodi	Permasa	Çmimi
HSL08040	40 cm	<b>890</b>
HSL08060	60 cm	<b>1.350</b>

### NIVELUES ALUMINI I FREZUAR DOREZA E GOMUAR

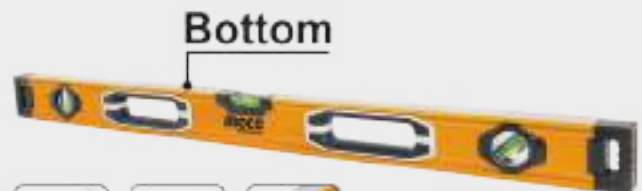

Kodi	Permasa	Çmimi
HSL08080	80 cm	<b>1.550</b>
HSL08100	100 cm	<b>1.690</b>



### NIVELUES ALUMINI I FREZUAR ME DOREZE TE GOMUAR

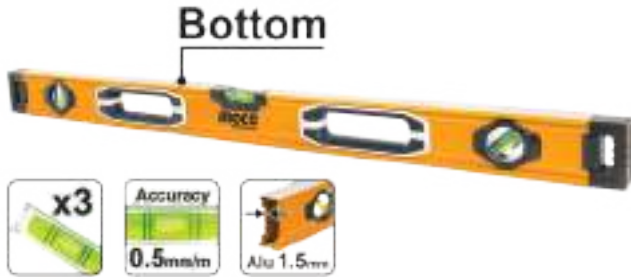

Kodi	Permasa	Çmimi
HSL08120	120 cm	<b>1.990</b>
HSL08150	150 cm	<b>2.150</b>

### NIVELUES ALUMINI I FREZUAR ME DOREZE TE GOMUAR



Kodi	Permasa	Çmimi
HSL08180	180 cm	<b>2.490</b>
HSL08200	200 cm	<b>2.850</b>

### NIVELUES ALUMINI ME 3 NIVELE ME MAGNET



Kodi	Permasa	Çmimi
HSL28060	60 cm	<b>990</b>
HSL28080	80 cm	<b>1.350</b>

### NIVELUES ALUMINI ME 3 NIVELE ME MAGNET



Kodi	Permasa	Çmimi
HSL28100	100 cm	<b>1.550</b>
HSL28120	120 cm	<b>1.690</b>

### NIVELUES ALUMINI I FREZUAR ME MAGNET

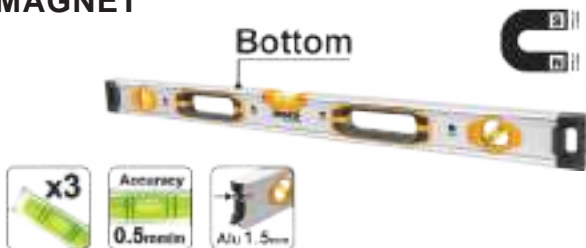

Kodi	Permasa	Çmimi
HSL38040M	40 cm	<b>1.250</b>
HSL38060M	60 cm	<b>1.690</b>
HSL38080M	80 cm	<b>1.990</b>

### NIVELUES ALUMINI I FREZUAR ME MAGNET

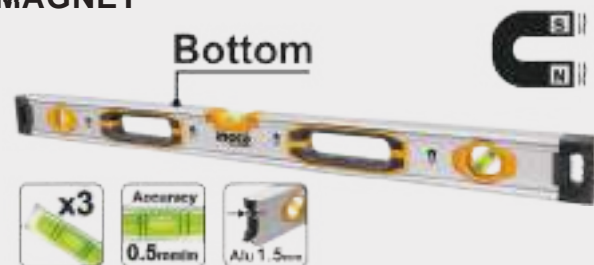

Kodi	Permasa	Çmimi
HSL38100M	100 cm	<b>2.350</b>
HSL38120M	120 cm	<b>2.550</b>

### NIVELUES MURATORI ALUMINI ME 3 TREGUES



Kodi	Permasa	Çmimi
HBSL08030	30 cm	<b>1.190</b>

### NIVELUES ALUMINI ME 2 ANE



Kodi	Permasa	Çmimi
HSR36003	60 cm	<b>790</b>

### METER I VERDHË



Kodi	Permasa	Çmimi
HSMT39316-1	3m x 16 mm	<b>150</b>
HSMT39519-1	5m x 19 mm	<b>270</b>

### METER I VERDHË



Kodi	Permasa	Çmimi
HSMT39525-1	5m x 25 mm	<b>270</b>
HSMT39825-1	8m x 25 mm	<b>490</b>

### METER I VERDHE PLASTIK



Kodi	Permasa	Çmimi
HSMT26316-1	3 m x 16 mm	<b>160</b>
HSMT26525-1	5 m x 25 mm	<b>350</b>

### METER ME GOMINE ME BLOKIM AUTOMATIK



Kodi	Permasa	Çmimi
HSMT08316-1	3 m x 16 mm	<b>260</b>
HSMT08519-1	5 m x 19 mm	<b>320</b>

### METER ME GOMINE ME BLOKIM AUTOMATIK



Kodi	Permasa	Çmimi
HSMT08525-1	5 m x 25 mm	<b>360</b>
HSMT08825-1	8 m x 25 mm	<b>530</b>

### METER PROFI ME GOMINE 3 PERÇINA ME 2 ANE



Kodi	Permasa	Çmimi
HSMT88052	5 x 19 mm	<b>540</b>
HSMT8805	5 x 25 mm	<b>630</b>

### METËR ME GOMINE ME TRE PERCINA ME FUNKSION



Permasa 5 x 19 mm

### METER ME GOMINE ME 3 PERCINA DHEAUTOBLOKIM ME DOPIO BUTON



Permasa 5 x 25 mm

### METER I VERDHE ME 3 PERCINA DHE GOMINE



690

HSMT081025-1

Permasa

10 m x 25 mm  
Me gomine

### METER ME GOMINE ME DY ANE



Kodi	Permasa	Çmimi
HSMT88052.1	5 m x 19 mm	<b>450</b>
HSMT8805.1	5 m x 25 mm	<b>530</b>
HSMT8808.1	8 m x 25 mm	<b>790</b>

### METER SHIRIT



790

HFMT8120

Permasa

20 m x 12.5 mm

### METER SHIRIT



890

HSMT8420

Permasa

20 m x 12.5 mm

### METER SHIRIT



990

HFMT8330

Permasa

30 m x 12.5 mm

### METER SHIRIT



Kodi	Permasa	Çmimi
HFMT8250	50 m x 12.5 mm	<b>1.690</b>
HSMT8550	50 m x 12.5 mm	<b>1.690</b>
HFMT82100	100 m x 12.5 mm	<b>1.690</b>

### SPANGO ME BOJE



490

HCLR0130

Permasa

30 m

### KALIBER DIXHITAL PLASTIK ME BATERI 3V



790

HDCP16150

Leximi

150 mm



### KALIBER DIXHITAL ME BATERI 3V IP54



Kodi	Permasa	Çmimi
HDCD28150	150 mm	<b>2.690</b>
HDCD28200	200 mm	<b>3.390</b>

### VIZORE ALUMINI E VERDHE

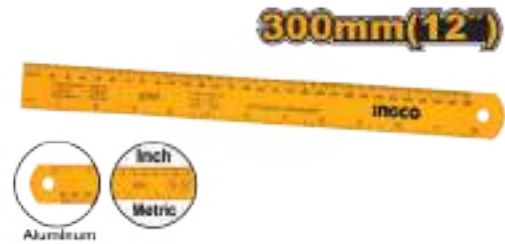

Kodi	Permasa	Çmimi
HSR23002	30 cm	<b>150</b>
HSR26002	60 cm	<b>350</b>

### KALIBER INOXI



Permasa 150 mm

### KALIBER INOXI



Permasa 200 mm

### MATES THELLESIE DIXHITAL 3 V



Leximi 0 - 25.4 mm

### VIZORE KENDESH DIXITALE ME BATERI 3V



Matja Leximi 0-360°, 0-200mm, 0-400mm, 180°  
0.05°, 0.1mm/0.01"

### VIZORE KENDORE ALUMINI



Gjatesia 300 mm  
Thellesia 40 mm

### VIZORE KENDORE PLASTIKE



Permasa 7"  
Materiali ABS

### CANTE SHPINE PER MBAJTJEN E VEGLAVE

2.990  
HBP0101



### BREZ VEGLASH ME 6 DHE 4 XHEPA

**IRI**



Kodi	Permasa	Çmimi
HTBP03011	6 xhepa	<b>530</b>
HTBP40128	4 xhepa	<b>350</b>

### BREZ VEGLASH ME 10 XHEPA

1.350  
HTBP01011



### BREZ VEGLASH ME 14 DHE 10 XHEPA



Kodi	Permasa	Çmimi
HTBP02031	14 xhepa	<b>1.550</b>
HTBP020328	10 xhepa	<b>1.190</b>

### JELEK PUNE ME 7 XHEPA 42X60X3CM

1.690  
HTVT0901



### KUTI PLASTIKE ORGANIZUESE AKSESORESH

**12"**

490  
PBX1211



### KUTI PLASTIKE ORGANIZUESE AKSESORESH

690  
PBX1511



### VALIXHE VEGLASH PLASIKE 14"

790  
PBX1401



**CANTE VEGLASH 13" ME 6 XHEPA  
TE JASHEM**

**690**

**HTBG281328**



**CANTE VEGLASH 16" ME 6 XHEPA  
TE JASHEM DHE 8 TE BRENDHEM**

**1.190**

**HTBG281628**



**CANTE VEGLASH 13"**

**1.590**

**HTBG05**



**CANTE VEGLASH 16"**

**3.190**

**HTBG03**



**CANTE VEGLASH ME 25 XHEPA**

**ERE**

**2.890**

**HTBG10**



With **25** Pockets  
Max Load **20** kgs

**CANTE VEGLASH ME 19 XHEPA**

**ERE**

**4.990**

**HRRTB2015**



With **19** Pockets  
Max Load **20** kgs

**CANTE VEGLASH ME 16 DHE 18 XHEPA**

**ERE**



Kodi	Permasa	Çmimi
<b>HTBG09</b>	24" me 18 xhepa	<b>2.850</b>
<b>HTBG08</b>	16" me 16 xhepa	<b>1.690</b>

**CANTE RROBE PER VEGLA ME  
7 DHE 21 XHEPA**

**ERE**



Kodi	Permasa	Çmimi
<b>HTBGL01</b>	16" me 21 xhepa	<b>4.450</b>
<b>HTBGL04</b>	16" me 7 xhepa	<b>2.150</b>



**VALIXHE VEGLASH PLASTIKE 17"**

**17"** **436x220x205mm**  
 Weight:1390g

**1.250**  
**PBX1701**



**VALIXHE VEGLASH PLASTIKE 20"**

**20"** **508x296x261mm**  
 Weight:2150g

**1.990**  
**PBX2001**



**VALIXHE PLASTIKE 14" ME KAPESE METALIKE (KAPACITETI MBAJTES 10 KG)**

**890**  
**PBX1402**



**VALIXHE PLASTIKE 17" ME 2 KAPESE METALIKE (KAPACITETI MBAJTES 15 KG)**

**1.450**  
**PBX1702**



**VALIXHE PLASTIKE 20" ME 2 KAPESE METALIKE (KAPACITETI MBAJTES 20 KG)**

**20"** **508x296x261mm**  
 Weight:2190g

**2.150**  
**PBX2002**



**SET ME 2 VALIXHE PLASTIKE ME KAPESE PLASTIKE ( 17"+ 14")**

**1.690**  
**PBXK0201**



**SET ME 3 VALIXHE PLASTIKE 14" , 17" , 20" ME KAPESE PLASTIKE**

**3.890**  
**PBXK0301**



**SET ME 3 VALIXHE PLASTIKE 14"/17"/20" ME KAPESE METALIKE**

**4.490**  
**PBXK0302** 3Pcs/set



1  
2  
3  
4  
5  
6  
7  
8  
9  
10

**Valixhe Black plastike me doreze dhe kapese metalike**



Kodi	“	Permasa	Paketimi	Çmimi
ME-03	19”	255x480x230	9	<b>1.990</b>
ME-04	22”	295x555x265	6	<b>2.790</b>

**Valixhe Plastike me kapese plastike**



Kodi	“	Permasa	Paketimi	Çmimi
PO-06	13”	320x150x135	12	<b>690</b>
PO-07	16”	410x200x180	12	<b>990</b>
PO-05	19”	480x230x230	9	<b>1.390</b>
PO-08	22”	535x267x276	6	<b>2.390</b>

**Mini rafte me ndarje**



Kodi	Ndarja	Permasa	Paketimi	Çmimi
PL-04	6/29	315x140x385	4	<b>2.500</b>
PL-06	9/47	585x323x569	4	<b>3.500</b>

**Valixhe Plastike me doreze dhe kapese metalike**



Kodi	“	Permasa	Paketimi	Çmimi
ML-05	24”	607x314x277	1	<b>3.900</b>

**Valixhe Plastike me kapese plastike**



Kodi	“	Permasa	Paketimi	Çmimi
SE-01	16”	210x395x177	12	<b>1.290</b>
SE-02	18”	233x458x247	9	<b>1.990</b>
SE-03	21”	276x535x267	6	<b>2.790</b>

**Mini rafte me 20 ndarje e kuqe**



Kodi	Ndarja	Permasa	Paketimi	Çmimi
PH04-R	20	425x140x335	4	<b>4.900</b>

**Mini rafte me 20 ndarje e zeze**



Kodi	Ndarja	Permasa	Paketimi	Çmimi
PH04-B	20	425x140x335	4	<b>3.900</b>

### Organizues kutish metalike



Kodi	Permasa	Permban	Çmimi
AD02	260x700x1600	84 kuti	<b>59.900</b>

### Organizues kutish metalike

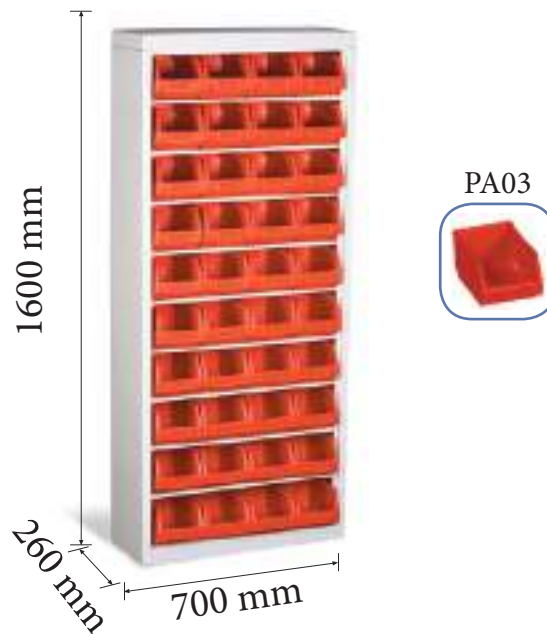

Kodi	Permasa	Permban	Çmimi
AD03	260x700x1600	40 kuti	<b>59.900</b>

### Kuti organizuese rafti



Kodi	Permasa	Paketimi	Çmimi
PC010	120x50x50	128	<b>100</b>
PC013	140x80x80	80	<b>220</b>
PC014	140x110x110	60	<b>290</b>
PCR010	120x50x50	128	<b>129</b>

### Kuti plastike blu per aksesore



Kodi	Permasa	Paketimi	Çmimi
SA04L-B	419x165x265	6	<b>990</b>

### Kuti plastike e zeze per aksesore



Kodi	Permasa	Paketimi	Çmimi
PA02-Z	160x82x100	48	<b>120</b>
PA03-Z	230x125x153	48	<b>220</b>
PA04-Z	335x165x210	24	<b>450</b>

### Kuti plastike e kuqe per aksesore



Kodi	Permasa	Paketimi	Çmimi
PA02-R	160x82x100	48	<b>150</b>
PA03-R	230x125x153	48	<b>350</b>
PA04-R	335x165x210	24	<b>650</b>



**Ekspozitor me 6 faqe i kuq**

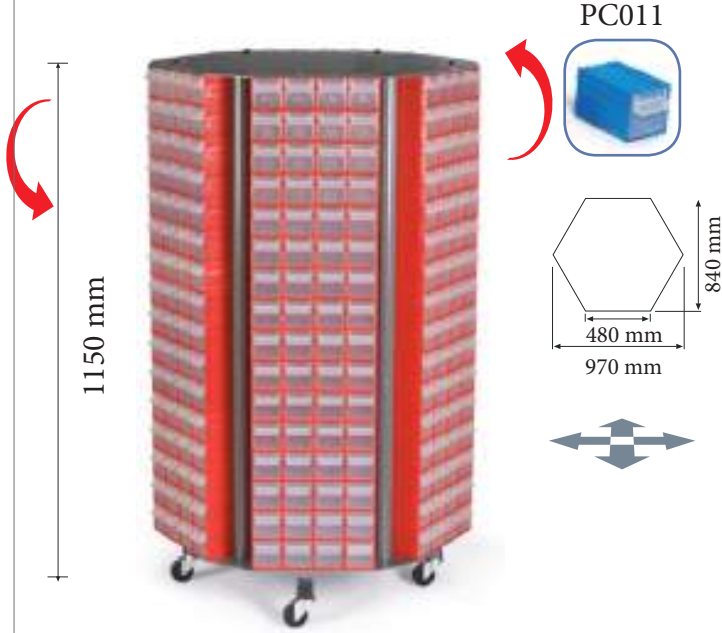

Kodi	Permasa	Permban	Çmimi
CKM.30	840x970x1520	432 kuti	<b>145.000</b>

**Ekspozitor me 6 faqe i kuq**

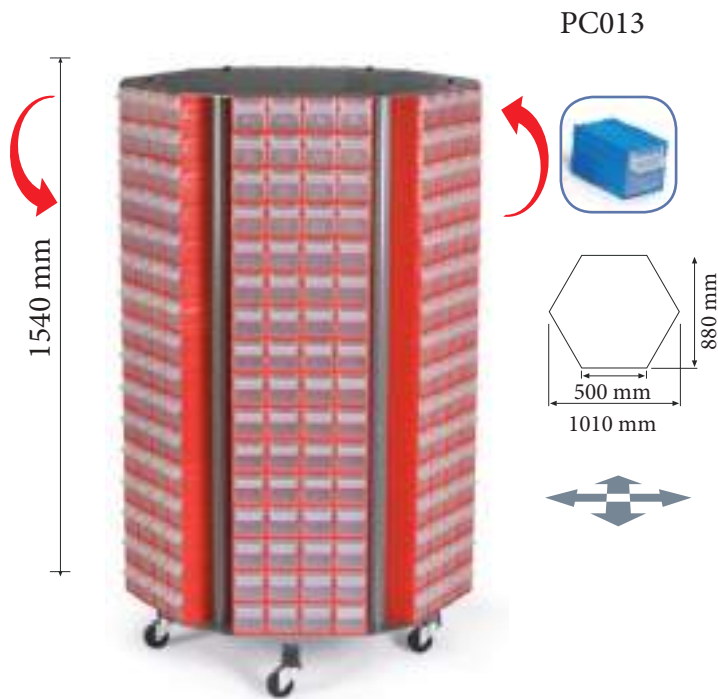

Kodi	Permasa	Permban	Çmimi
CKM.40	880x1010x1540	384 kuti	<b>145.000</b>



made in  
**Germany**  
**BMI**

### Meter "twoCOMP"

Metër me mekanizëm të fortë, rezistencë ndaj goditjes.



Kodi	Çmimi	Permasat	
		L (m)	I (mm)
472341021	<b>690</b>	3	16
472541021	<b>990</b>	5	19
472841021	<b>1.500</b>	8	25
472041021	<b>2.500</b>	10	30

### Meter "Viso"

Kuti plastike, rezistent ndaj goditjes.  
Meter me tre funksione :  
- matja gjatesore  
- matja e brendshme  
- vizatimi i qarqeve

Lapsi çelikut ju lejon te vizatoni qarqe me diameter deri ne 6m.

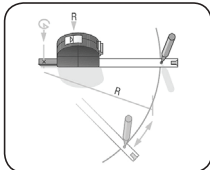

Kodi	Permasat		Çmimi
	L (m)	I (mm)	
405341020	3	16	<b>1.690</b>

### BMI-Meter me hapje te shpejte

Karakteristikat:

- shirit çeliku i smaltuar;
- karkase plastike, rezistente ndaj goditjes;
- i papershkrueshem nga uji
- butoni ergonomik GO / STOP
- saktesia sipas Klasit II te KE-se



Model	Kodi	Permasat		Çmimi
		L (m)	I (mm)	
BMI - 2 m	429241021	2	16	<b>990</b>
BMI - 3 m	429341021	3	16	<b>1.490</b>

### Meter "Radius" ne karkase

Shirit çeliku, i smaltuar me ngjyre te bardhe.



Kodi	Gjatesia	Gjeresia	Çmimi
501214010BF	10	13	<b>3.990</b>
501214015BF	15	13	<b>4.650</b>
501214025BF	25	13	<b>4.900</b>
501214050BF	50	13	<b>5.500</b>

### Nivuelues "Torpedo"

Model i forte i perforcuar me fibra qelqi ABS.  
Jepet modeli 685 M  
me dy disqe fiksuese magnetike

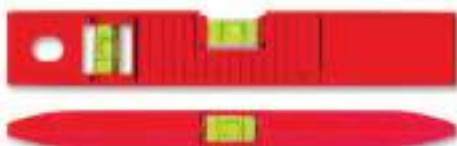

Model	Kodi	Dimensioni	Çmimi
685 - pa magnet	685025003	250 x 43 x 22	<b>1.350</b>
685 M - me fiksime magnetik	685025003M		<b>1.990</b>



### Nivuelues xhepi "Pocket"



Model	Kodi	Dimensioni	Çmimi
Xhepi	670010003	100 x 35 x 13	<b>1.250</b>

### Nivelues "Ecoline"

Modeli standart.  
 Profil i fortë dhe i butë alumini  
 Ngjyra e verdhë  
 Saktësia e matjes në pozicion normal: 1 mm/m

Gjatesia (cm)	Çmimi	Artikulli
40	1.590	689040P-CON
60	1.990	689060P-CON
80	2.200	689080P-CON
100	2.300	689100P-CON
150	3.990	689150P-CON
200	4.900	689200P-CON

### Nivelues "Eurostar"

Modele me cilësi të lartë me dy fluska niveli - vertikale dhe horizontale, me efekt lente.  
 Shënimi me lazer në fluska niveli siguron një saktësi prej 0.5 mm/m  
 2% pjerrësi e shënuar në fluskën horizontale  
 Shenja shtesë, për saktësi, në të gjitha fluskat e nivelit.





2 fluska niveli		
40	2.200	690040E
60	2.300	690060E
80	2.690	690080E
100	2.900	690100E
120	3.390	690120E
150	4.900	690150E

2 magnet fiksues		
40	3.500	690040EM
60	4.500	690060EM
80	5.300	690080EM
100	6.290	6900100EM
120	6.500	6900120EM

### Nivelues "Alustar"

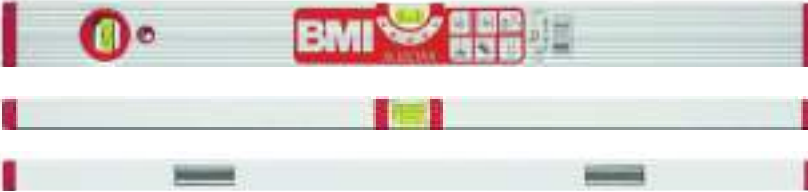
Modele me cilësi të lartë niveli me skaje gjysmë të bombarduara dhe efekt lente (patentë BMI). Fluskat e nivelit të salduar në mënyrë ultrasonike sigurojnë një saktësi prej 0.05 mm/m, gjatë gjithë jetës së nivelit. Saktësi e lartë (0.75 mm/m) për matjet e kundërta Mure rezistente dhe koka gome. Në modelet 691 W dhe WM, fluskat e nivelit mund të rrotullohen për të matur këndin e pjerrësisë.

Fluske niveli te fiksuar dhe me skaje gjysem te bombarduara		
40	2.990	694040E
60	3.290	694060E
80	3.590	694080E
100	3.990	694100E

### Nivelues "Robust"

Profil unik me 4 dhoma rezistente në rrotullim me seksion 60x26 mm dhe trashësi muri 2mm.  
 Fluska niveli me skaje gjysmë të bombarduara dhe efekt lente (patentë BMI)  
 Fluskat e nivelit të ngjitur sigurojnë një saktësi prej 0.5 mm/m.  
 Skajet e holla të gomës nuk ndikojnë në saktësinë e matjes.  
 Dy sipërfaqe të frezuara për matje preçize.





Fluske niveli me seksion 60x26		
40	5.500	698040
60	5.990	698060
80	6.500	698080

Fluske niveli me efekt te lentes se profilit		
100mm	6.900	698100
100mm	7.500	698100D

Fluske niveli me seksion		
150	9.900	698150
200	10.500	698200



## Nivelues "Winkelstar"

Lidhje plastike me cilesi te larte, jashtezakonisht rezistente



Kendi i drejte i jashtem



Kendi i drejte i jashtem



Kendi i drejte i jashtem



Kendi i drejte i jashtem



Kendi i drejte i jashtem



Kendi i drejte i jashtem

Kodi	Dimensioni	Cmimi
715060120	60 x 120 cm	<b>12.500</b>

## Meter distance me lazer



### Meter distance me lazer 40 m

Kodi	<b>658040-LDM</b>
Fusha veprimit	0.05-40 m
Intervali	± 2.0 mm
Bateri	2 x LR3
Fikje automatike	150 sekonda
Cmimi	<b>13.500</b>



### Meter distance me lazer 100 m

Kodi	<b>658100-LDM</b>
Fusha veprimit	0.05-100 m
Intervali	± 1.5 mm
Bateri	3 x 1.5 V
Fikje automatike	I rregullueshem
Cmimi	<b>39.000</b>

## Nivelues me lazer autoCROSS 3

**Vete nivelim !**

Funksioni i vete-nivelimit eleminon kohen e vendosjes dhe garanton saktesine duke perdorur nje lavjerrës magnetik.



Shenjat per dyshemetë dhe linjat elektrike



Tavan



Zdrukthari



Shtrimi i pllakave qeramike

### Nivelues me lazer autoCROSS 3

Kodi	<b>654-AC4R</b>
Veterregullimi	automatike
Precizioni	± 1.5 mm / 10 m
Intervali	± 4°
Fusha veprimit	0 - 30 m
Diapazoni	45° ne te gjithe drejtimet rrot 360°
Mban	3 x 1.5 V
Cmimi	<b>24.900</b>

Pajisja me 2 rreze lazer dhe funksion vete-nivelues per gjenerimin e rrafshëve pingule. 2 rrezet lazermund te aktivizohen vecmas.Mund te perdoret per vizatimin e vijes optike. Vjen me bateri.

Sensor per zbulimin automatik te tejkalimit te intervalit te rrafshimit. Funksioni i fiksimit te vijes optike - modeli i vete - nivelimit eshte kycur dhe linja dhe linja optike mund te vensoset ne cdo kend.

## Meter AutoCROSS me baze magneti dhe lazer jeshile

**Vete nivelim !**



### Meter autoCross me lazer jeshil

Kodi	<b>654-AC4G</b>
Veterregullimi	automatike
Precizioni	± 1.5 mm / 10 m
Intervali	± 4°
Fusha veprimit	0 - 30 m
Cmimi	<b>24.900</b>

## Kiti "uniLazerAH"

Sistem nivelimi per matje te ndryshme, efikas dhe i sigurte ne te gjitha situatat  
 Nivelimi mund te behet nga nje person.  
 Diapazon deri ne 150 m  
 Funksion vete-nivelues me saktesi 3 mm / 30 m

Lazerrrotullues  
 Receptor  
 Telekomande  
 Kit karikimi  
 Bateri NiMH 4 x1.5 V  
 Konsol muri  
 Ne valixhe plastike



## Kit uniLazerAH"

<b>Kodi</b>	<b>6480AHSETK2</b>
Veterregullimi	automatike
Precizioni	± 3.0 mm / 30 m
Intervali	± 5°
Fusha veprimit	0 - 30 m
Autonomia	aprox. 20 ore
Mban	4 x 1.5 V
<b>Cmimi</b>	<b>74.900</b>

## MultiLazer3D me vije te kuqe



M 6 vija laseri te cilat mund te shfaqen njekohesisht.  
 3 Vija laseri te dukshme (1 horizontale, 2 vertikale)

<b>Kodi</b>	<b>654-3DR</b>
Klasa e lazerit	Klasa 2
Saktesia	+ 2 mm / 10 m
Lidhja me tripod	1/4"
Fusha veprimit	15 - 50 m
<b>Cmimi</b>	<b>43.900</b>

## MultiLazer3D me vije jeshile



Funksioni i vetenivelimit ju garanton saktesi .  
 Dedektim automatik - zona jashte nivelimit

<b>Kodi</b>	<b>654-3DG</b>
Klasa e lazerit	Klasa 2
Saktesia	+ 2 mm / 10 m
Lidhja me tripod	1/4"
Fusha veprimit	15 - 50 m
<b>Cmimi</b>	<b>69.900</b>

## Tripod

Kembe teleskopike me pika te mprehta.  
 Kapja 1/4"  
 Koka metalike 3-D  
 Lartesia minimale 63 cm  
 Lartesia max 170 cm  
 Filluske niveli  
 Peshja 1020 g



<b>Kodi</b>	<b>711212-02</b>
<b>Cmimi</b>	<b>7.900</b>

## Tripod i rregullueshem

Ndertim i forte prej alumini siguron ngritjen me ane te tubave teleskopike.  
 Kembe teleskopike me maje  
 Filluske niveli  
 5/8"



<b>Kodi</b>	<b>711400L</b>
<b>Cmimi</b>	<b>28.500</b>

## Tripod i rregullueshem

Ndertim i forte prej alumini siguron ngritjen me ane te tubave teleskopike.  
 Kembe teleskopike me maje  
 Filluske niveli  
 5/8"



<b>Kodi</b>	<b>711317</b>
<b>Cmimi</b>	<b>19.900</b>

## Tripod teleskopik



<b>Kodi</b>	<b>70521300</b>
<b>Cmimi</b>	<b>7.500</b>

## Mates niveli automatik



<b>Kodi</b>	<b>6462024SET</b>
Distanca	150 m
Precizioni	± 2.5 mm
Hapja lentes	36 mm
Klasa e mbrojtes	IP 67
Fuqia zmadhuese	24x
<b>Cmimi</b>	<b>49.900</b>





**VEESHJE DHE SISTEME**

**SIGURIE NË PUNË**



**RRIP SIGURIMI POLIESTER**

Kodi	Pershkrimi	Çmimi
MH101	Me 3 pozicione rregullimi	2.200

**RRIPA PER NGRITJE PALETASH**

Kodi	Pershkrimi	Çmimi
TH300061	1t x 4m x 30mm	490
TH300078	2t x 2m x 50mm	550
TH300085	2t x 3m x 50mm	650
TH300092	2t x 4m x 50mm	800
TH300108	2t x 5m x 50mm	990
TH300115	2t x 6m x 50mm	1.190
TH300122	3t x 2m x 75mm	790
TH300139	3t x 3m x 75mm	990
TH300149	3t x 4m x 75mm	1.290
TH300153	3t x 5m x 75mm	1.350
TH300160	3t x 6m x 75mm	1.850
TH300177	3t x 8m x 75mm	2.200
TH300207	4t x 3m x 100mm	1.350
TH300214	4t x 4m x 100mm	1.690
TH300221	4t x 5m x 100mm	1.990
TH300238	4t x 6m x 100mm	2.490
TH300269	4t x 12m x 100mm	4.200
TH300290	5t x 5m x 125mm	2.290
TH300306	5t x 6m x 125mm	2.900
TH300313	5t x 8m x 125mm	3.500

**RRIP SIGURIMI ÇENGEL**

Kodi	Pershkrimi	Çmimi
ML203	13 mm x 1.8 m, 25 KN	2.390

**ÇENGEL REZERVE INOXI**

Kodi	Pershkrimi	Çmimi
HD1	Per rrip sigurimi	990

**RRIPA PER NGRITJE PALETASH**

Kodi	Pershkrimi	Çmimi
TH300382	2t x 3m	850
TH300399	2t x 5m	1.350
TH300405	3t x 3m	1.190
TH300412	3t x 5m	1.890
TH300429	5t x 5m	2.500
TH300436	5t x 6m	2.990

**LITAR SHTRENGIMI BAGAZHI**

Kodi	Pershkrimi	Çmimi
TH300443	1.5t x 6m x 38mm	650
TH300467	3t x 6m x 50mm	990

**GAMBETA TE ZINGUARA**

Kodi	Pershkrimi	Çmimi
TH300481	5mm	25
TH300498	6mm	29
TH300504	8mm	45
TH300511	10mm	60
TH300528	12mm	80
TH300535	16mm	150
TH300542	20mm	250
TH300559	22mm	330
TH300566	25mm	450
TH300573	28mm	690
TH300580	32mm	950

**MORSETE KAVO METALIKE**

Kodi	Pershkrimi	Çmimi
TH300672	Morsete kavo metalike 3mm	6
TH300689	Morsete kavo metalike 5mm	8
TH300696	Morsete kavo metalike 7mm	10
TH300702	Morsete kavo metalike 8mm	15
TH300719	Morsete kavo metalike 19mm	79
TH300726	Morsete kavo metalike 22mm	120

**GREP SIGURIMI I ZINGUAR PA SIGURESE**

Kodi	Pershkrimi	Çmimi
TH300863	6x60mm	39
TH300870	8x80 mm	59
TH300887	9x90 mm	79
TH300894	10x100 mm	99
TH300900	12x140 mm	179

**FASHETA METALIKE**

Kodi	Pershkrimi	Çmimi
TH300597	5x6mm	12
TH300603	6x7mm	15
TH300610	7x8mm	16
TH300627	9x10mm	22
TH300634	12x13mm	24
TH300641	15x16mm	69
TH300658	16x18mm	79
TH300665	20x22mm	149

**TIRANTA METALIKE**

Kodi	Pershkrimi	Çmimi
TH300740	Tiranta metalike M6	139
TH300757	Tiranta metalike M8	169
TH300764	Tiranta metalike M10	220
TH300771	Tiranta metalike M12	290
TH300788	Tiranta metalike M16	450
TH300795	Tiranta metalike M20	650

**GREP SIGURIMI I ZINGUAR PA SIGURESE**

Kodi	Pershkrimi	Çmimi
TH300801	6x60mm	39
TH300818	7x70mm	49
TH300825	8x80mm	59
TH300832	9x90mm	79
TH300849	10x100mm	99

## GREP SIGURIMI I ZINGUAR ME DADO



Kodi	Pershkrimi	Çmimi
TH300917	5 mm	29
TH300924	6 mm	39
TH300931	7 mm	59
TH300948	8 mm	69
TH300955	12 mm	190

## GAMBET INOXI EUROPIANE



Kodi	Pershkrimi	Çmimi
TH301037	5 mm	89
TH301044	6 mm	99
TH301051	8 mm	149
TH301068	10 mm	220
TH301075	12 mm	350

## GREP VINCI GANXHA 320 I KUQ



Kodi	Pershkrimi	Çmimi
TH301129	39-201 mm, 3 T	1.490
TH301136	51-256 mm, 5 T	2.900

## KARRUKULL E ZINGUAR



Kodi	Pershkrimi	Çmimi
TH300962	Karrukull e zinguar 15mm	59
TH300979	Karrukull e zinguar 20mm	99
TH300986	Karrukull e zinguar 25mm	115
TH300993	Karrukull e zinguar 30mm	190
TH301006	Karrukull e zinguar 40mm	250
TH301013	Karrukull e zinguar 50mm	390

## GREP VINCI GANXHA 80 I KUQ



Kodi	Pershkrimi	Çmimi
TH301099	3.15 T, 10-8mm	1.100
TH301105	5.3 T, 13-8mm	1.990
TH301112	8 T, 16-8mm	3.900

## LITAR SHTERNGIMI

**VOREL**

Kodi	Pershkrimi	Çmimi
TH82351	25mmx5m, 420gr	650



## MAKARA ME ZINXHIR



Kodi	Fuqja	Çmimi
HCBK0101	1 Ton	<b>8.500</b>
HCBK0102	2 Ton	<b>11.500</b>

## MAKARA ME ZINXHIR



Kodi	Fuqja	Çmimi
HCBK0103	3 Ton	<b>14.900</b>
HCBK0105	5 Ton	<b>19.500</b>

## LITAR SHTRENGIMI



Kodi	Pesha / Permasa	Çmimi
HRSP262	1.5 T / 6 m	<b>990</b>
HRSP2101	2 T / 10 m	<b>1.450</b>
HRSP361	3 T / 6 m	<b>1.690</b>
HRSP5101	5 T / 10 m	<b>2.890</b>

## LITAR SHTRENGIMI



Kodi	Pesha / Permasa	Çmimi
HRSP2107	2 T / 10 m	<b>890</b>
HRSP3107	3 T / 10 m	<b>1.550</b>
HRSP5107	5 T / 10 m	<b>1.690</b>

## SET ME 4 RRIPA SIGURIMI

**ERE** 25 mm 0.65T x 6m

**2.590**

HRSP065607

Permasa 0.65 T x 6 m

## RRIPA SIGURIMI

**ERE** 1Tx3m

**690**

HWSP0103

Thicker layers

Permasa 1 T x 3 m  
Gjeresia 30 mm

## RRIPA SIGURIMI

**ERE**

Thicker layers

Kodi	Pesha / Permasa	Çmimi
HWSP0203	2 T x 3 m / 60 mm	<b>1.190</b>
HWSP0204	2 T x 4 m / 60 mm	<b>1.390</b>

## RRIPA SIGURIMI

**ERE**

Thicker layers

Kodi	Pesha / Permasa	Çmimi
HWSP0303	3 T x 3 m / 90 mm	<b>1.590</b>
HWSP0306	3 T x 6 m / 90 mm	<b>2.890</b>

**JELEK PUNE ME XHEPA TORINO 260 G/M2**

**BPP7011**

MASA- M

**BPP7013**

MASA- XL

**BPP7012**

MASA- L

**BPP7014**

MASA- XXL

JELEK PUNE me xhepa TORINO  
Perberja materialit: 80% Polyester  
& 20% Cotton, 260g/m2  
MBYLLJA: me zinxhir  
Perforcim OXFORD  
MASAT: M - XXL

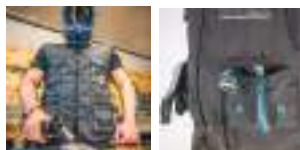

**2.900**

**JELEK ROMA 100 % POLIESTER**

**BPP7058**

MASA- S

**BPP7060**

MASA- L

**BPP7062**

MASA- XXL

**BPP7059**

MASA- M

**BPP7061**

MASA- XL

JELEK ROMA 100 % POLIESTER  
Perberja materialit: 100% Polyester  
MBYLLJA: me zinxhir  
Me 2 xhepa  
MASAT: S- XXL



**3.290**



**PULOVER PUNE ME ZINXHIR DHE KAPUC 300 GSM**

**BPP7053**

MASA- M

**BPP7055**

MASA- XL

**BPP7054**

MASA- L

**BPP7056**

MASA- XXL

PULOVER PUNE me zinxhir  
dhe kapuc 300 GSM  
Perberja materialit: 100% Polyester  
Perforcim OXFORD 100D  
MBYLLJA: me zinxhir  
Me 2 xhepa  
MASAT: M- XXL



**5.900**



**PANTALLONA PUNE TORINO**

<b>BPP7001</b>	MASA- M
<b>BPP7002</b>	MASA- L
<b>BPP7004</b>	MASA- XL
<b>BPP7005</b>	MASA-XXL



**2.590**

**KOMINOSHE PUNE 260G/M2**

<b>BPP7006</b>	MASA- M
<b>BPP7007</b>	MASA- L
<b>BPP7009</b>	MASA- XL
<b>BPP7010</b>	MASA-XXL



**2.990**

**PULOVER PUNE  
ME ZINXHIR PARMA 400 GR**



**3.200**

<b>BPP7021</b>	MASA- M
<b>BPP7024</b>	MASA- XXL

**KOMINOSHE PUNE TORINO**

<b>BPP7064</b>	MASA- M
<b>BPP7065</b>	MASA- L
<b>BPP7067</b>	MASA- XL
<b>BPP7068</b>	MASA-XXL

KOMINOSHE PUNE Torino  
FABRIKIMI - PERBERJA:  
260g/m2  
Mbyllja: me zinxhir  
XHEPA: 6  
pelhure perforcuese  
MASAT: M-XXL



**4.900**



1  
2  
3  
4  
5  
6  
7  
8  
9  
10



**JELEK PUNE BORMANN PA KRAHE****BWV1003-1** MASA- L**BWV1004-1** MASA- XL

JELEK PUNE me xhepa  
Perberja materialit: 100% Polyester  
220gr/m2  
MBYLLJA: me zinxhir  
Me 4 xhepa  
MASAT: L - XL

**3.990****HODIE JESHILE E ERRET****BPP7225** MASA- L**BPP7226** MASA- XL

Hodie jeshile e erret  
350gr/m2  
MBYLLJA: me zinxhir  
Me 2 xhepa  
MASAT: L - XL

**4.250****BLUZE ME MENGE TE GJATE E ZEZE****BPP7229** MASA- L**BPP7230** MASA- XL

Bluze me menge te gjate e zeze  
Perberja materialit: 80% Pambuk  
Polyester: 20%  
300gr/m2  
MASAT: L - XL

**2.900****PELERINE SHIU E VERDHE****BPP7205** MASA- L**BPP7206** MASA- XL**BPP7207** MASA- XXL

Pelerine shiu e verdhe PVC  
Kundra ujit

**1.290**

## KOMPLET SHIU BLU I ERRET NAVY

**74657**

MASA- L

**74659**

MASA-2XL

Komplet shiu blu i erret  
NAVY PVC



**1.490**



## VEESHJE SHIU USHTARAKE ME AJROSJE

**74646**

MASA- L

**74647**

MASA- XXL

Veshje shiu ushtarake  
Me ajrosje Polyester/PVC



**1.690**



## JELEK FOSFORESHENT PORTOKALLI

**74660**

MASA- L

**74663**

MASA- 3XL

Jelek fosforeshent portokalli  
Me ajrosje



**290**



## KON RRUGESH PORTOKALLI

**BPP2485**

Per automjete



**1.100**

**BORMANN**  
PRO

## TREKENDESH SIGURIE

**83280**

274x274x450mm  
1.27KC



**750**

## DOREZA PUNE E GOMUAR E VERDHE



Kodi	Permasa	Çmimi
PN3-8	M, 288cp	<b>90</b>
PN3-9	L, 288cp	<b>90</b>
PN3-10	XL, 288cp	<b>90</b>

## DOREZA PUNE E GOMUAR PREMIUM E KUQE



Kodi	Permasa	Çmimi
PN75-9	L, 288cp	<b>110</b>
PN75-10	XL, 288cp	<b>110</b>

## DOREZA PUNE E GOMUAR ANTI RRESHQITSE ZEBRA



Kodi	Permasa	Çmimi
PN3Z-8	M, 288cp	<b>100</b>
PN3Z-9	L, 288cp	<b>100</b>
PN3Z-10	XL, 288cp	<b>100</b>

## DOREZA PASTRIMI PVC TE KUQE



Kodi	Permasa	Çmimi
EKO-8	M 8" 28gr, 200cp	<b>90</b>
EKO-9	L 9" 28gr, 200cp	<b>90</b>

## DOREZA PUNE PER XHAMA XL



Kodi	Permasa	Çmimi
CUT-9	L 9" 28gr, 288cp	<b>330</b>
CUT-10	XL 10" 28gr, 288cp	<b>330</b>

## DOREZA MBROJTJESE NITRIL JESHILE KUNDRA KIMIKATEVE



Kodi	Permasa	Çmimi
NTL38-8	M, 38gr, 120cp	<b>420</b>
NTL38-9	L, 38gr, 120cp	<b>420</b>
NTL38-10	XL, 38gr, 120cp	<b>420</b>

## DOREZA MBROJTJESE TE GJATA LATEX TE ZEZA XXL 11" 60CM

**790**

**KORUN-60**



## DOREZA SALDIMI KEVLAR XL 10" 250 GR

**950**

**KYN-01**





**DOREZA REZISTENTE NDAJ PRERJES**

**ERE**

**350**

**HGCG02-XL**



**DOREZA NITRILE TE VESHURA**

**ERE**

**290**

**HGNF01**



**DOREZA NITRILE TE VESHURA XL**

**ERE**

**170**

**HGNF03**



**DOREZA NITRILE XL**

**ERE**

**90**

**HGNG04**



**DOREZA TE VESHURA ME POLIURETAN XL**

**ERE**

**90**

**HGPUG01**



**DOREZA TE VESHURA ME POLIURETAN**

**ERE**

**70**

**HGPUG02**



**DOREZA PUNE ME PIKA**

**ERE**

**70**

**HGVK05**



**DOREZA PVC**

**ERE**

**130**

**HGVP03**



- 1
- 2
- 3
- 4
- 5
- 6
- 7
- 8
- 9
- 10

**DOREZA PVC**

**E RE**

**130**

**HGVP04**



**DOREZA PUNE TE GOMUAR  
TE VERDHA**

**12Pairs/Paper**



Kodi	Permasa	Çmimi
HGNG01.L	L	<b>100</b>
HGNG01	XL	<b>100</b>

**DOREZA PUNE LEKURE TE VERDHA 10 “**

**1.090**

**HGVC02**



**DOREZA PUNE TE GOMUARA  
TE VERDHA XL**

**1Pair/Paper**

**220**

**HGVL03**



**DOREZA PUNE TE GOMUARA TE  
VERDHA XL SUPER SELECT**

**12Pairs/Paper**

**160**

**HGVL05**



**DOREZA PUNE ME VESHJE LATEX XL**

**1P**

**230**

**HGVL08-XL**



**DOREZA PUNE ME VESHJE TE PLOTE  
LATEX XL**

**250**

**HGVL04-XL**



**6Pairs/Paper**

**DOREZA PUNE ME VESHJE LATEX  
XL**

**100**

**HGVL06**



### DOREZA NAFTE TE GOMUARA TE VERDHA



Kodi	Permasa	Çmimi
HGVN01-L	L	250
HGVN01	XL	250

### DOREZA PUNE LEKURE TE VERDHA XL



400  
HGVC01

Add one piece of leather more to be stonger.

### DOREZA MEKANIKU MICROFIBER XL

800  
HGMG01-XL



### DOREZA MEKANIKU MICROFIBER + PVC XL

1.350  
HGMG02-XL



### DOREZA PUNE PER XHAMA XL



500  
HGCG01-XL



### DOREZA PUNE REZISTENTE NDAJ PRERJES, MASA XL



530  
HGCG08-XL



### DOREZA NITRILE L (PAKETIMI 1000 COPE)

**E RE**

12  
HGNG02-L



### DOREZA PASTRIMI PVC 32CM L

1Pair/Plastic bag

Size:L

140  
HGVP01



- 1
- 2
- 3
- 4
- 5
- 6
- 7
- 8
- 9
- 10



**MASKE NJE PERDORISHME  
(PAKETIMI 50 COPE)**

**20**  
HDM31



**MASKE MBROJTESE  
(PAKETIMI 50 COPE)**

**E RE**

**30**  
HDM04



**MASKE PUNE ME FILTER  
ANESORE**

**E RE**

**40**  
HDM07



**MASKE MBROJTESE  
ME FILTER FFP2**

**E RE**

**90**  
HDM02



**MASKE MBROJTESE ME FIBER  
KARBONI ME FILTER FFP2**

**E RE**

**90**  
HDM08



**KUFJE MBROJTESE**

**NRR:24dB**

**630**  
HEM01



**TAMPON VESHESH**

**50**  
HEP02



**SYZE MBROJTESE E BARDHE  
E GOMUAR**

**Elastic headband**

**180**  
HSG02



**HELMETE NDERTIMI E VERDHE**



**HELMETE NDERTIMI E BARDHE**



**HELMETE NDERTIMI E KUQE**



**HELMETE NDERTIMI BLU**



**HELMETE NDERTIMI E VERDHE**



**HELMETE NDERTIMI E BARDHE**



**LLAMBE KOKE 100 LUMENS**



**LLAMBE KOKE ME 3 BATERI AAA 200 LUMENS**



1  
2  
3  
4  
5  
6  
7  
8  
9  
10

**SYZE E BARDHE ME MBROTJESE ANESORE**

**200**  
**HSG04**



**SYZE MBROJTESE E BARDHE**

**270**  
**HSG05**



**SYZE MBROJTESE E ZEZE DIN 8**

**250**  
**HSG06**



**SYZE MBROJTESE DIN 9**

**290**  
**HSG08**



**SYZE MBROJTESE TRANSPARENTE**

**ERE**

**390**  
**HSG10**



**GJUNJEZA ME MBROJTJE PVC 215 X 180 MM**

**1.550**  
**HKPT0101**



**JELEK FOSFORESHENT I VERDHE & PORTOKALLI, MASA XL**



**RRIPA SIGURIMI**

**2.190**  
**HSH501502**



Kodi	Permase	Çmimi
RV03C	XL / i verdhe	<b>380</b>
RV02C	XL / portokalli	<b>380</b>



**DOREZA PUNE RROBE**

**30**  
**WKG2801**



Masa XI

**DOREZA PUNE RROBE ME GRIMCA PVC**

**50**  
**WKG1801**



Masa 10 (XI)

**DOREZA NITRILE**

**70**  
**WGV2801**



Masa XI

**DOREZA NITRILE ME MIKROSHKUME**

**150**  
**WGV2803**



Masa XI

**DOREZA LATEX**

**90**  
**WXG3802**



Masa XI

**DOREZA LATEX ME VESHJE KUNDER TE FTOHTIT**

**130**  
**WXG3803**



Masa XI

**SYZE MBROJTESE DIN 4**

**100**  
**WSG3808**



**DOREZA PUNE ME VESHJE TE PLOTE LATEX NR 10"**



**250**  
**74160**



- 1
- 2
- 3
- 4
- 5
- 6
- 7
- 8
- 9
- 10

## PELERINE SHIU

## PELERINE SHIU



Kodi	Permase	Çmimi
HRCTL031.M	M	<b>1.450</b>
HRCTL031.L	L	<b>1.450</b>
HRCTL031.XL	XL	<b>1.450</b>

Kodi	Permase	Çmimi
HRCTL031.XXL	XXL	<b>1.450</b>
HRCTL031.XXXL	XXL	<b>1.450</b>

## SET VESHJE SHIU



Kodi	Permase	Çmimi
HRCTSKT031.M	M	<b>1.590</b>
HRCTSKT031.L	L	<b>1.590</b>
HRCTSKT031.XL	XL	<b>1.590</b>

## SET VESHJE SHIU



Kodi	Permase	Çmimi
HRCTSKT031.XXL	XXL	<b>1.590</b>
HRCTSKT031.XXXL	XXXL	<b>1.590</b>

## XHAKETE INGCO ME ZINXHIR



Kodi	Permase	Çmimi
HJATL2281.L	L	<b>2.390</b>
HJATL2281.XL	XL	<b>2.390</b>
HJATL2281.XXL	XXL	<b>2.390</b>

## VESHJE PUNE



155g PER SQUARE METER



Kodi	Permase	Çmimi
WUC01150.M	M	<b>890</b>
WUC01150.L	L	<b>890</b>
WUC01150.XL	XL	<b>890</b>

## VESHJE PUNE KOMINOSHE



155g PER SQUARE METER

Kodi	Permase	Çmimi
WUC02235.M	M	<b>1.350</b>
WUC02235.L	L	<b>1.350</b>



## VESHJE PUNE KOMINOSHE



155g PER SQUARE METER

Kodi	Permase	Çmimi
WUC02235.XL	XL	<b>1.350</b>
WUC02235.XXL	XXL	<b>1.350</b>

### GJYSEM CIZME LLASTIKU



Kodi	Permasa	Çmimi
SSH102L.39	39	<b>990</b>
SSH102L.40	40	<b>990</b>
SSH102L.41	41	<b>990</b>
SSH102L.42	42	<b>990</b>

### GJYSEM CIZME LLASTIKU



Kodi	Permasa	Çmimi
SSH102L.43	43	<b>990</b>
SSH102L.44	44	<b>990</b>
SSH102L.45	45	<b>990</b>

### CIZME LLASTIKU TE GJATA



Kodi	Permasa	Çmimi
SSH092L.39	39	<b>1.350</b>
SSH092L.40	40	<b>1.350</b>
SSH092L.41	41	<b>1.350</b>
SSH092L.42	42	<b>1.350</b>

### CIZME LLASTIKU TE GJATA



Kodi	Permasa	Çmimi
SSH092L.43	43	<b>1.350</b>
SSH092L.44	44	<b>1.350</b>
SSH092L.45	45	<b>1.350</b>

### CIZME LLASTIKU TE GJATA ME HEKUR



Kodi	Permasa	Çmimi
SSH092S1P.39	39	<b>1.690</b>
SSH092S1P.40	40	<b>1.690</b>
SSH092S1P.41	41	<b>1.690</b>
SSH092S1P.42	42	<b>1.690</b>

### CIZME LLASTIKU TE GJATA ME HEKUR



Kodi	Permasa	Çmimi
SSH092S1P.43	43	<b>1.690</b>
SSH092S1P.44	44	<b>1.690</b>
SSH092S1P.45	45	<b>1.690</b>

### KEPUCE PUNE LEKURE ME MBROJTJE NGA ELEKTRICITETI



Kodi	Permasa	Çmimi
SSH07IDSB.39	39	<b>2.990</b>
SSH07IDSB.40	40	<b>2.990</b>
SSH07IDSB.41	41	<b>2.990</b>
SSH07IDSB.42	42	<b>2.990</b>

### KEPUCE PUNE LEKURE ME MBROJTJE NGA ELEKTRICITETI



Kodi	Permasa	Çmimi
SSH07IDSB.43	40	<b>2.990</b>
SSH07IDSB.44	41	<b>2.990</b>
SSH07IDSB.45	42	<b>2.990</b>



### KEPUCE PUNE LEKURE PA QAFE



Kodi	Permasa	Çmimi
SSH03SB.39	39	<b>2.750</b>
SSH03SB.40	40	<b>2.750</b>
SSH03SB.41	41	<b>2.750</b>

### KEPUCE PUNE LEKURE PA QAFE



Kodi	Permasa	Çmimi
SSH03SB.42	41	<b>2.750</b>
SSH03SB.43	42	<b>2.750</b>
SSH03SB.44	43	<b>2.750</b>

### KEPUCE PUNE LEKURE ME QAFE



Kodi	Permasa	Çmimi
SSH04SB.39	39	<b>2.950</b>
SSH04SB.40	40	<b>2.950</b>
SSH04SB.41	41	<b>2.950</b>
SSH04SB.42	42	<b>2.950</b>

### KEPUCE PUNE LEKURE ME QAFE



Kodi	Permasa	Çmimi
SSH04SB.43	43	<b>2.950</b>
SSH04SB.44	44	<b>2.950</b>
SSH04SB.45	45	<b>2.950</b>

### KEPUCE PUNE KASTOR ME QAFE



Kodi	Permasa	Çmimi
SSH02SB.39	39	<b>2.990</b>
SSH02SB.40	40	<b>2.990</b>
SSH02SB.41	41	<b>2.990</b>
SSH02SB.42	42	<b>2.990</b>

### KEPUCE PUNE KASTOR ME QAFE



Kodi	Permasa	Çmimi
SSH02SB.43	43	<b>2.990</b>
SSH02SB.44	44	<b>2.990</b>
SSH02SB.45	45	<b>2.990</b>
SSH02SB.46	46	<b>2.990</b>

### KEPUCE PUNE KASTOR ME HEKUR



Kodi	Permasa	Çmimi
SSH02S1P.39	39	<b>3.490</b>
SSH02S1P.40	40	<b>3.490</b>
SSH02S1P.41	41	<b>3.490</b>
SSH02S1P.42	42	<b>3.490</b>

### KEPUCE PUNE KASTOR ME HEKUR



Kodi	Permasa	Çmimi
SSH02S1P.43	43	<b>3.490</b>
SSH02S1P.44	44	<b>3.490</b>
SSH02S1P.45	45	<b>3.490</b>

### KEPUCE KAMOSHI ME QAFE



Kodi	Permasa	Çmimi
SSH08SB.39	39	<b>3.590</b>
SSH08SB.40	40	<b>3.590</b>
SSH08SB.41	41	<b>3.590</b>
SSH08SB.42	42	<b>3.590</b>

### KEPUCE KAMOSHI ME QAFE



Kodi	Permasa	Çmimi
SSH08SB.43	43	<b>3.590</b>
SSH08SB.44	44	<b>3.590</b>
SSH08SB.45	45	<b>3.590</b>

### KEPUCE PUNE LEKURE ME QAFE ME HEKUR LARTE DHE POSHTE



Kodi	Permasa	Çmimi
SSH12S1P.39	39	<b>3.790</b>
SSH12S1P.40	40	<b>3.790</b>
SSH12S1P.41	41	<b>3.790</b>
SSH12S1P.42	42	<b>3.790</b>

### KEPUCE PUNE LEKURE ME QAFE ME HEKUR LARTE DHE POSHTE



Kodi	Permasa	Çmimi
SSH12S1P.43	43	<b>3.790</b>
SSH12S1P.44	44	<b>3.790</b>
SSH12S1P.45	45	<b>3.790</b>

### KEPUCE LEKURE ME QAFE ME HEKUR LARTE DHE POSHTE



Kodi	Permasa	Çmimi
SSH22S1P.39	39	<b>3.790</b>
SSH22S1P.40	40	<b>3.790</b>
SSH22S1P.41	41	<b>3.790</b>

### KEPUCE LEKURE ME QAFE ME HEKUR LARTE DHE POSHTE



Kodi	Permasa	Çmimi
SSH22S1P.42	42	<b>3.790</b>
SSH22S1P.43	43	<b>3.790</b>
SSH22S1P.44	44	<b>3.790</b>

### ATLETE PUNE ME MBROJTJE



Kodi	Permasa	Çmimi
SSH81SB.39	39	<b>2.990</b>
SSH81SB.40	40	<b>2.990</b>
SSH81SB.41	41	<b>2.990</b>
SSH81SB.42	42	<b>2.990</b>

### ATLETE PUNE ME MBROJTJE



Kodi	Permasa	Çmimi
SSH81SB.43	43	<b>2.990</b>
SSH81SB.44	44	<b>2.990</b>
SSH81SB.45	45	<b>2.990</b>

### ATLETE PUNE ME MBROJTJE LARTE



Kodi	Permasa	Çmimi
WSB1539	39	<b>2.200</b>
WSB1540	40	<b>2.200</b>
WSB1541	41	<b>2.200</b>
WSB1542	42	<b>2.200</b>

### ATLETE PUNE ME MBROJTJE LARTE



Kodi	Permasa	Çmimi
WSB1543	43	<b>2.200</b>
WSB1544	44	<b>2.200</b>
WSB1545	45	<b>2.200</b>
WSB1546	46	<b>2.200</b>

### ATLETE PUNE ME MBROJTJE LARTE DHE POSHTE



Kodi	Permasa	Çmimi
WSB4539	39	<b>2.500</b>
WSB4540	40	<b>2.500</b>
WSB4541	41	<b>2.500</b>
WSB4542	42	<b>2.500</b>

### ATLETE PUNE ME MBROJTJE LARTE DHE POSHTE



Kodi	Permasa	Çmimi
WSB4543	43	<b>2.500</b>
WSB4544	44	<b>2.500</b>
WSB4545	45	<b>2.500</b>
WSB4546	46	<b>2.500</b>

### KEPUCE PUNE LEKURE ME MBROJTJE LARTE PA QAFE



Kodi	Permasa	Çmimi
WSB2539	39	<b>2.500</b>
WSB2540	40	<b>2.500</b>
WSB2541	41	<b>2.500</b>
WSB2542	42	<b>2.500</b>

### KEPUCE PUNE LEKURE ME MBROJTJE LARTE PA QAFE



Kodi	Permasa	Çmimi
WSB2543	43	<b>2.500</b>
WSB2544	44	<b>2.500</b>
WSB2545	45	<b>2.500</b>
WSB2546	46	<b>2.500</b>

### KEPUCE PUNE LEKURE ME MBROJTJE LARTE DHE POSHTE PA QAFE



Kodi	Permasa	Çmimi
WSB5539	39	<b>2.700</b>
WSB5540	40	<b>2.700</b>
WSB5541	41	<b>2.700</b>
WSB5542	42	<b>2.700</b>

### KEPUCE PUNE LEKURE ME MBROJTJE LARTE DHE POSHTE PA QAFE



Kodi	Permasa	Çmimi
WSB5543	43	<b>2.700</b>
WSB5544	44	<b>2.700</b>
WSB5545	45	<b>2.700</b>
WSB5546	46	<b>2.700</b>





**SISTEME FIKSIMI**

**DHE BULONERI**

**WFD Ø 4.8**
**VIDE EXAGON ME MAJE PUNTO**

Kodi	Permasa	Sasia	Çmimi
WFD-48025-9006	4.8x25	250	<b>5.0</b>
WFD-48035-9006	4.8x35	250	<b>5.5</b>
WFD-48055-9006	4.8x55	200	<b>7.0</b>
WFD-48070-9006	4.8x70	200	<b>7.0</b>

**WFD Ø 4.8**
**VIDE EXAGON ME MAJE PUNTO KAFE**

Kodi	Permasa	Sasia	Çmimi
WFD-48025-3011	4.8x25	250	<b>5.5</b>
WFD-48035-3011	4.8x35	250	<b>6.0</b>
WFD-48055-3011	4.8x55	200	<b>7.0</b>
WFD-48070-3011	4.8x70	200	<b>11.0</b>
WFD-48100-3011	4.8x100	100	<b>18.0</b>

**WSDSK**
**VIDE PHILIPS ME MAJE PUNTO SPECIALE**

Kodi	Permasa	Sasia	Çmimi
WSDSK-48032	4.8X32	500	<b>5.0</b>
WSDSK-48038	4.8X38	250	<b>6.0</b>
WSDSK-48045	4.8X45	250	<b>9.0</b>
WSDSK-48050	4.8X50	250	<b>10.0</b>

**PEPDM**
**RONDELE ME GOMINE PER VIDA VETEFILLETUESE**

Kodi	Permasa	Sasia	Çmimi
PEPDM-14	M 4.8	500	<b>6.0</b>
PEPDM-16	M 5.5	500	<b>8.0</b>
PEPDM-19	M 6.3	500	<b>9</b>

**WSW-6 Ø 5.5**
**VIDE EXAGON ME MAJE PUNTO**

Kodi	Permasa	Sasia	Çmimi
WSW-6-55085-A19	5.5x85	100	<b>20</b>
WSW-6-55105-A19	5.5x105	100	<b>25</b>
WSW-6-55125-A19	5.5x125	100	<b>39</b>
WSW-6-55150-A19	5.5x150	100	<b>45</b>

**WSPC Ø 4.2**
**VIDE TRUST ME MAJE PUNTO**

Kodi	Permasa	Sasia	Çmimi
WSPC-42013	4.2x13	1000	<b>2.2</b>
WSPC-42016	4.2x16	1000	<b>2.5</b>
WSPC-42019	4.2x19	1000	<b>2.9</b>
WSPC-42025	4.2x25	500	<b>3.7</b>
WSPC-42032	4.2x32	500	<b>3.9</b>
WSPC-42045	4.2x45	300	<b>5.0</b>
WSPC-42055	4.2x55	300	<b>6.9</b>

**WPC**
**VIDE TRUST ME MAJE**

Kodi	Permasa	Sasia	Çmimi
WPC-42013	4.2X13	1000	<b>2.7</b>
WPC-42016	4.2X13	1000	<b>2.8</b>
WPC-42019	4.2X19	1000	<b>3.5</b>
WPC-42032	4.2X32	500	<b>3.9</b>
WPC-42040	4.2X40	400	<b>5.0</b>
WPC-42050	4.2X50	300	<b>6.0</b>

**WSB**
**VIDE VETEFILLETUESE ME KOKE HEXAGON**

Kodi	Permasa	Sasia	Çmimi
WSB-48016	4.8x16	500	<b>4.5</b>
WSB-48019	4.8x19	500	<b>5.0</b>



## INJEKSION KIMIK EPOXID

### WCF-EASF

- Baze epoxide
- Performane e larte
- Per beton te perforuar
- Tulle
- Qeramike



C1/C2  
(C2-vellem per  
prizhionet dhe upa)



Kodi	Temperatura	Sasia	Çmimi
WCF-EASF-410	50-300°C	12	<b>1.490</b>

## TSN

### KAUSH INJEKSIONI RRJETE PER MBJELLJE





Kodi	Permasa	Sasia	Çmimi
TSN-02	15x85	20	<b>35</b>
TSN-03	15x130	20	<b>39</b>

## LE-ZN

### UPA METALIKE TE RENDA



Kodi	Permasa	Sasia	Çmimi
			
LE-ZN-08115	8x115	50	<b>52</b>

## WDBLS

### VIDE BETONI EKSPRES HEXAGON



Kodi	Permasa	Sasia	Çmimi
WDBLS-08060	8x60	50	<b>55</b>
WDBLS-10060	10x60	50	<b>110</b>
WDBLS-10090	10x90	50	<b>139</b>
WDBLS-10110	10x110	50	<b>149</b>
WDBLS-10120	10x120	50	<b>169</b>
WDBLS-10140	10x140	50	<b>199</b>

## FURCE PER PASTRIMIN E PLUHURIT TE INJEKSIONIT



### SCF

### Metalike

Kodi	Permasa (mm)	Çmimi
SCF-13	10	<b>990</b>

## KRM

### UPE METRIKE BRONZ

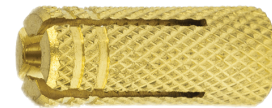

Kodi	Permasa	Sasia	Çmimi
KRM-080624	M6x24x8	50	<b>45</b>
KRM-100831	M8x31x10	50	<b>75</b>
KRM-121034	M10x34x12	50	<b>125</b>

## TSW

### UPE METRIKE TE ZINGUARA



Kodi	Permasa	Sasia	Çmimi
TSW-06	M6x25x8	50	<b>25</b>
TSW-08	M8x30x10	50	<b>35</b>



# KSSG

## Vide gipsi vetefiletuse



PN-EN 14566



Koke PH2

E pershtatshme per te gjithë sistemet e kapjes



Koke e sheshte

E dizenuar per te mos lene gjurme pas montimi



Maje vetefiletuese

Per shpim direkt ne metale

### KSSG

#### VIDE GIPSI VETEFILETUESE E ZEZE

Kodi	Permasa	Sasia	Çmimi
KSSG-35025	3.5x25	1000	2.0
KSSG-35035	3.5x35	1000	2.5
KSSG-35045	3.5x45	500	4.5

### KSGM 3.5, 4.2, 4.8

#### VIDE GIPSI ME FILETO TE IMET



Kodi	Permasa	Sasia	Çmimi
KSGM-35025	3.5x25	1000	1.6
KSGM-35035	3.5x35	1000	2.2
KSGM-35045	3.5x45	500	2.5

# KSTEX

## Vide e shkurter vetefiletuese



PN-EN 14566



Koke PH2

E pershtatshme per cdo sistem fiksimi



Koke e rumbullaket

Per mbeshjtjellje te plote ne material



Maje vetefiletuese

Per shpim direkt ne metale

### KSTEX

#### VIDE GIPSI VETEFILETUESE E ZINGUAR / E ZEZE



Kodi	Permasa	Sasia	Çmimi
KSTEX-35095-B	3.5X9.5	1000	3



Kodi	Permasa	Sasia	Çmimi
KSTEX-35095	3.5X9.5	1000	3

### WPF

#### VIDE DRURI TRUST



Kodi	Permasa	Sasia	Çmimi
WPF-42013	4.2X13	1000	4.5

**GKK / GWK**

 UPE GIPSI PLASTIKE ME FLETE  
 UPE GIPSI PLASTIKE ME FLETE + VIDE

Kodi	Permasa	Sasia	Çmimi
GKK	10x50	200	<b>7.9</b>
GWK	10x50	100	<b>9.9</b>

**DRN-23**

UPA GIPSI PLASTIKE KERMILL



Kodi	Permasa	Sasia	Çmimi
DRN-23	23	200	<b>3.5</b>

**DRZN-29**

UPA GIPSI METALIKE KERMILL



Kodi	Permasa	Sasia	Çmimi
DRZN-29	29	200	<b>35</b>

**KDR**

ADAPTOR PER UPA GIPSI



Kodi	Sasia	Çmimi
KDR	1	<b>79</b>

**SMK UPE PROFILE GIPSI PLASTIKE ME GODITJE**
**SMNK UPE PROFILE GIPSI NAJLONI ME GODITJE**

**Pershkrimi**

Upe gipsi me goditje plastike / najloni

**Te dhena teknike**
**Tipi instalimit** Me shtytje direkte  
 Gips, Beton, tulle, beton arme

**Perberja dhe mbrojtja**

 PP  
 polypropylene

**100%  
 nylon**

 Blue  
 Zinc

Kodi	Permasa	Sasia	Çmimi
SMK-06040	6X40	200	<b>4</b>
SMK-06060	6X60	200	<b>6</b>
SMK-06080	6X80	100	<b>7</b>
SMNK-06040	3.9X45	200	<b>5</b>
SMNK-06060	3.9X65	100	<b>7</b>
SMNK-06080	3.9X85	100	<b>9</b>

**PX**

**SET UPE WX + ÇENGEL L**



Kodi	Permasa	Sasia	Çmimi
PX-06	6x30	200	<b>3.9</b>
PX-08	8x40	100	<b>6.5</b>
PX-10	10X50	100	<b>10</b>
PX-12	12X60	100	<b>16</b>

**WX**

**SET UPE WX + ÇENGEL ME HARK**



Kodi	Permasa	Sasia	Çmimi
WX-06	6x30	100	<b>4.0</b>
WX-08	8x40	100	<b>7.0</b>
WX-10	10X50	100	<b>15</b>
WX-12	12X60	100	<b>25</b>

**M-C**

**UPE GIPSI FLUTUR ME ÇENGEL (C)**



Kodi	Permasa	Sasia	Çmim
M-05075-C	5x75	25	<b>89</b>
M-05090-C	5x95	25	<b>95</b>

**M-O**

**UPE GIPSI FLUTUR ME ÇENGEL (O)**



Kodi	Permasa	Sasia	Çmimi
M-05075-O	5x75	25	<b>89</b>
M-05090-O	5x95	25	<b>99</b>

**M**

**UPE PER GIPSI FLUTUR ME BULLON**



Kodi	Permasa	Sasia	Çmimi
M-04050	4x50	50	<b>66</b>
M-04075	4x75	50	<b>69</b>
M-05090	5x90	25	<b>75</b>

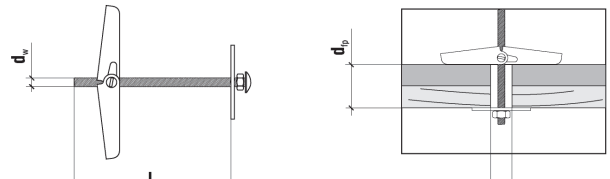



**ZK**
**KENDORE GIPSI METALIKE ME VRIMA**

Kodi	Permasa	Sasia	Çmimi
ZK-8	0.6	100	<b>52</b>

**WK**
**KAPESE GIPSI ANESORE METALIKE**

Kodi	Permasa	Sasia	Çmimi
WK-60-60-08	0.8	100	<b>45</b>
WK-60-270-08	0.8	100	<b>55</b>

**ES**
**KAPESE GIPSI METALIKE**

Kodi	Permasa	Sasia	Çmimi
ES-60-75-08	60x75	100	<b>45</b>

**ZPD**
**KENDORE METALIKE GIPSI**

Kodi	Permasa	Sasia	Çmimi
ZPD	0.6	100	<b>65</b>

**WSO**
**KENDORE GIPSI METALIKE ME KAPESE**

Kodi	Permasa	Sasia	Çmimi
WSO-60-100-08	0.8	100	<b>90</b>

**WDH**
**KAPESE GIPSI METALIKE ME HARK**

Kodi	Permasa	Sasia	Çmimi
WDH	0.7	100	<b>45</b>

**ESP**
**KAPESE GIPSI METALIKE ME CEPA**

Kodi	Permasa	Sasia	Çmimi
ESP-60-75-08	60x75	100	<b>35</b>
ESP-60-125-08	60x125	100	<b>45</b>
ESP-60-175-08	60x175	100	<b>75</b>

**ZPP**
**KENDORE METALIKE GIPSI ME VRIME**

Kodi	Permasa	Sasia	Çmimi
ZPP-08	0.8	100	<b>65</b>

1

2

3

4

5

6

7

8

9

10

**LTX**

**UPE PLASTIKE POLISTEROLI + KUNJE PLASTIKE**



**WK THERM**

**UPE PLASTIKE POLISTEROLI + KUNJE METALIKE**



Kodi	Permasa	Sasia	Çmimi
LTX08175(200)	8x175	200	<b>15</b>
LTX08195(200)	8x195	200	<b>16</b>
LTX10110(200)	10x110	200	<b>15</b>
LTX10180(200)	10x180	200	<b>19</b>

Kodi	Permasa	Sasia	Çmimi
WK THERM08135	8x135	200	<b>19</b>
WK THERM08155	8x155	200	<b>22</b>
WK THERM08175	8x175	200	<b>25</b>
WK THERM08195	8x195	200	<b>29</b>
WK THERM08215	8x215	100	<b>35</b>
WK THERM08235	8x235	100	<b>39</b>
WK THERM08255	8x255	100	<b>50</b>

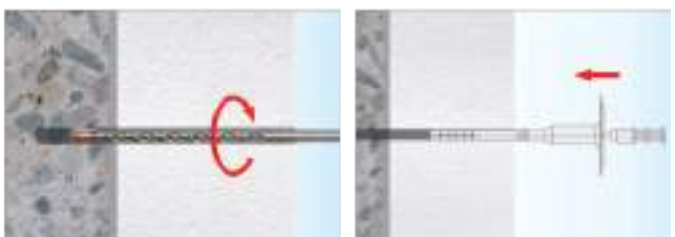

**PRERESE POLISTEROLI PLASTIKE**

**WK-FT**

Dimensionet 66.7 mm

**Specifikimet:**

Gote plastike per prerjen e polisterolit per trapan  
Prerese plastike per prerje polisteroli EPS  
Me diamter 66.7 mm

**990**



**KMH 3.0 / 3.5 / 4.0 / 5.0 / 6.0**
**VIDE DRURI**

Kodi	Permasa	Sasia	Çmimi
KMH-30012	3.0x12	2000	<b>1.0</b>
KMH-30016	3.0x16	2000	<b>1.1</b>
KMH-30020	3.0x20	2000	<b>1.3</b>
KMH-30025	3.0x25	1500	<b>1.4</b>
KMH-30030	3.0x30	1000	<b>1.5</b>
KMH-30035	3.0x35	1000	<b>1.6</b>
KMH-30040	3.0x40	500	<b>1.7</b>
KMH-35016	3.5x16	2000	<b>1.3</b>
KMH-35020	3.5x20	1500	<b>1.4</b>
KMH-35025	3.5x25	1000	<b>1.5</b>
KMH-35030	3.5x30	500	<b>1.7</b>
KMH-35035	3.5x35	500	<b>2.2</b>
KMH-35040	3.5x40	500	<b>2.5</b>
KMH-35045	3.5x45	500	<b>2.7</b>
KMH-35050	3.5x50	400	<b>2.9</b>
KMH-35060	3.5x60	400	<b>3.2</b>
KMH-40016	4.0x16	1000	<b>1.5</b>
KMH-40020	4.0x20	1000	<b>1.7</b>
KMH-40025	4.0x25	1000	<b>2.2</b>
KMH-40030	4.0x30	500	<b>2.4</b>
KMH-40035	4.0x35	500	<b>2.5</b>
KMH-40040	4.0x40	500	<b>2.9</b>
KMH-40045	4.0x45	300	<b>3.5</b>
KMH-40050	4.0x50	300	<b>3.9</b>
KMH-40060	4.0x60	200	<b>3.9</b>
KMH-40070	4.0x70	250	<b>4.7</b>

Kodi	Permasa	Sasia	Çmimi
KMH-50025	5.0x25	500	<b>2.9</b>
KMH-50030	5.0x30	500	<b>3.5</b>
KMH-50035	5.0x35	500	<b>3.9</b>
KMH-50040	5.0x40	500	<b>4.9</b>
KMH-50045	5.0x45	300	<b>5.2</b>
KMH-50050	5.0x50	300	<b>5.9</b>
KMH-50060	5.0x60	200	<b>6.3</b>
KMH-50070	5.0x70	200	<b>6.6</b>
KMH-50080	5.0x80	200	<b>7.2</b>
KMH-50090	5.0x90	200	<b>8.0</b>
KMH-50100	5.0x100	200	<b>9.9</b>
KMH-60040	6.0x40	200	<b>6.5</b>
KMH-60050	6.0x50	200	<b>7.3</b>
KMH-60060	6.0x60	200	<b>8.6</b>
KMH-60070	6.0x70	200	<b>8.9</b>
KMH-60080	6.0x80	200	<b>11</b>
KMH-60090	6.0x90	100	<b>12</b>
KMH-60100	6.0x100	100	<b>14</b>
KMH-60110	6.0x110	100	<b>16</b>
KMH-60120	6.0x120	100	<b>19</b>
KMH-60140	6.0x140	100	<b>27</b>
KMH-60160	6.0x160	100	<b>29</b>
KMH-60180	6.0x180	100	<b>35</b>
KMH-60200	6.0x200	100	<b>45</b>





# WKCP



## WKCP

### VIDE TRARËSH ME FILETO ME MAJE

#### Vidë trarësh WKCP me fileto në majë

Vida trarësh për lidhje të qëndrueshme të të gjitha materialeve si: dru masiv, dru i laminuar, panele konstrukcioni, trarë etj. Vidhosja me vidat WKCP nuk ka nevojë për shpim të mëparshëm.

Kodi	Permasa	Sasia	Çmimi
WKCP-08160	8.0x160	50	<b>49</b>
WKCP-08200	8.0x200	50	<b>65</b>
WKCP-08240	8.0x240	50	<b>89</b>
WKCP-10200	10x200	50	<b>115</b>
WKCP-10240	10x240	25	<b>135</b>
WKCP-10280	10x280	25	<b>165</b>
WKCP-10300	10x300	25	<b>185</b>
WKCP-10320	10x320	25	<b>195</b>
WKCP-10340	10x340	25	<b>199</b>

# PWKCS

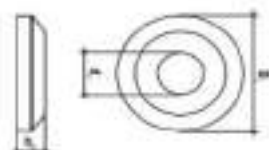

#### Vida me rondere PWKCS

#### Rondele për vida trarësh WS Ø 8 dhe Ø10

Rondelja për vidat e trarëve mban të qëndrueshme vidën dhe kur montohet me element metalik.

Kodi	Diametri	Dp x Hp (mm)	Paketimi	Çmimi
PWKCS-8	8.5	25x5	<b>50</b>	<b>35</b>
PWKCS-10	10	32x6	<b>50</b>	<b>59</b>

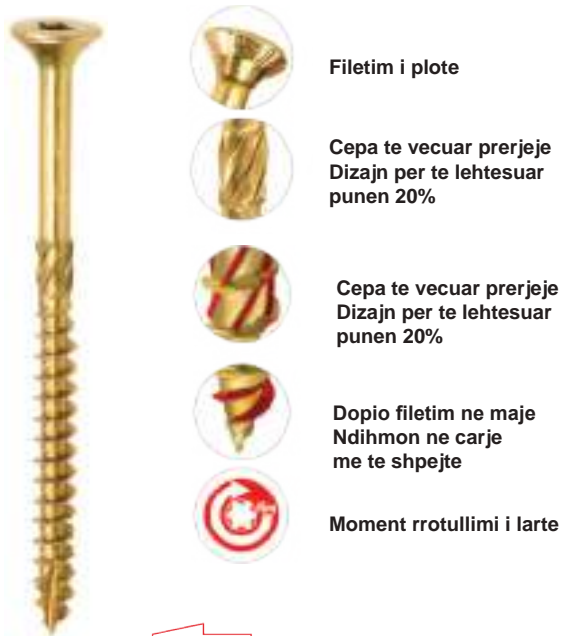

**KMWHT**
**VIDE TRARESH TORX ME CARJE**

Filetim i plote

 Cepa te vecuar prerjeje  
 Dizajn per te lehtesuar  
 punen 20%

 Cepa te vecuar prerjeje  
 Dizajn per te lehtesuar  
 punen 20%

 Doppio filetim ne maje  
 Ndihton ne carje  
 me te shpejte

Moment rrotullimi i larte

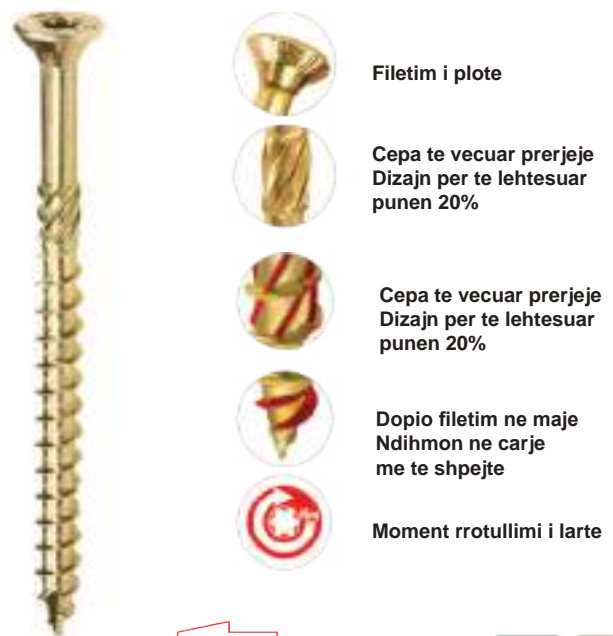
**WKCS**
**VIDE TRARESH TORX ME CARJE**

Filetim i plote

 Cepa te vecuar prerjeje  
 Dizajn per te lehtesuar  
 punen 20%

 Cepa te vecuar prerjeje  
 Dizajn per te lehtesuar  
 punen 20%

 Doppio filetim ne maje  
 Ndihton ne carje  
 me te shpejte

Moment rrotullimi i larte



Kodi	Permasa	Sasia	Çmimi
KMWHT-60060	6x60	200	<b>10</b>
KMWHT-60070	6x70	200	<b>13</b>
KMWHT-60080	6x80	200	<b>14</b>
KMWHT-60100	6x100	100	<b>16</b>
KMWHT-60120	6x120	100	<b>20</b>
KMWHT-60140	6x140	100	<b>22</b>
KMWHT-60160	6x160	100	<b>24</b>
KMWHT-60180	6x180	100	<b>38</b>
KMWHT-60200	6x200	100	<b>50</b>

Kodi	Permasa	Sasia	Çmimi
WKCS-08100	8x100	100	<b>25</b>
WKCS-08120	8x120	100	<b>29</b>
WKCS-08140	8x140	100	<b>35</b>
WKCS-08160	8x160	100	<b>45</b>
WKCS-08180	8x180	100	<b>69</b>
WKCS-08200	8x200	100	<b>75</b>



**SFX Ø5, Ø6, Ø8, Ø10**
**UPE PLASTIKE EXPRES**

Kodi	Permasa	Sasia	Çmimi
SFX-05025	5.0x25	400	<b>1.0</b>
SFX-08040	8.0x40	200	<b>2.2</b>

**KPX Ø6, Ø8, Ø10, Ø12, Ø14, Ø16**
**UPA PLASTIKE UNIVERSALE**

Kodi	Permasa	Sasia	Çmimi
KPX-06030	6.0x30	1000	<b>1.4</b>
KPX-08040	8.0x40	500	<b>2.9</b>
KPX-08050	8.0x50	400	<b>4.5</b>
KPX-10050	10x50	300	<b>5.5</b>
KPX-10060	10x60	200	<b>7.9</b>
KPX-12060	12x60	150	<b>11</b>
KPX-12080	12x80	100	<b>12</b>
KPX-14080	14x80	100	<b>15</b>
KPX-16100	16x100	50	<b>24</b>



Diameter i reduktuar i kokes, shpejtesi instalimi.



Valezime speciale per fiksime me efikas



Forme e vecante e perforuar.



Koka e zmadhuar per mbeshtetje dhe fiksime precize.



Te cara speciale per mos rrotullim te dores.

**KW**
**KENDORE E NGUSHTE E ZINGUAR**

Kodi	Permasa	Sasia	Çmimi
KW-02	30x30	100	<b>35</b>
KW-03	40x40	100	<b>39</b>
KW-04	50x50	100	<b>40</b>
KW-05	60x60	100	<b>59</b>
KW-06	75x75	100	<b>65</b>

**KS**
**KENDORE METALIKE E ZINGUAR E GJERE**

Kodi	Permasa	Sasia	Çmimi
KS-02	40x40	100	<b>50</b>
KS-03	60x60	50	<b>120</b>



**KPW**
**KENDORE METALIKE E PERFORCUAR**

Kodi	Permasa	Sasia	Çmimi
KPW-02	90x50	50	<b>150</b>
KPW-03	90x90	50	<b>220</b>
KPW-04	105x105	50	<b>300</b>
KPW-05	90x60	25	<b>180</b>
KPW-06	90x60	50	<b>180</b>
KPW-07	90x50	50	<b>120</b>
KPW-08	90x50	50	<b>200</b>
KPW-09	90x50	25	<b>250</b>
KPW-10	65x65	50	<b>220</b>

**KL**
**KENDORE METALIKE E ZINGUAR**

Kodi	Permasa	Sasia	Çmimi
KL-01	50x50	100	<b>89</b>
KL-02	70x70	50	<b>129</b>
KL-03	90x90	50	<b>269</b>
KL-04	105x105	50	<b>319</b>
KL-05	150x50	50	<b>149</b>

**LT**
**BASHKUES T MONTIMI E ZINGUAR**

Kodi	Permasa	Sasia	Çmimi
LT-01	70X50	50	<b>90</b>

**WB**
**KENDORE ME FLETE PER TRARE**

Kodi	Permasa	Sasia	Çmimi
WB-02	38x130	20	<b>220</b>
WB-04	41x125	20	<b>210</b>
WB-05	41x169	20	<b>190</b>
WB-06	46x100	20	<b>160</b>
WB-07	46x167	20	<b>190</b>
WB-08	47x100	20	<b>180</b>
WB-09	47x135	20	<b>210</b>
WB-10	50x125	20	<b>160</b>
WB-11	50x145	20	<b>250</b>
WB-12	60x100	20	<b>140</b>
WB-13	60x130	20	<b>210</b>
WB-14	60x150	20	<b>240</b>
WB-15	64x150	20	<b>240</b>
WB-16	64x158	20	<b>190</b>
WB-17	70x155	20	<b>190</b>
WB-18	41x125	20	<b>210</b>
WB-19	75x152	20	<b>190</b>
WB-20	76x210	20	<b>210</b>

**WP**
**KENDORE METALIKE PER TABAKE TE BARDHE**

Kodi	Permasa	Sasia	Çmimi
WP-01BI	75x100	20	<b>29</b>
WP-02BI	100x25	20	<b>66</b>
WP-05BI	175x225	20	<b>150</b>
WP-06BI	200x250	20	<b>190</b>

**BBA933**
**BULLONA TE ZINGUARA DIN 933 8.8**

Kodi	Permasa (mm)	Çmimi
BBA933-5x25	5x25	1.5
BBA933-5x30	5x30	1.8
BBA933-5x40	5x40	2.2
BBA933-6x15	6x15	2.9
BBA933-6x20	6x20	3.9
BBA933-6x30	6x30	4.5
BBA933-6x40	6x40	6.5
BBA933-6x50	6x50	7.9
BBA933-6x60	6x60	8.5
BBA933-6x70	6x70	9.9
BBA933-6x80	6x80	11.0
BBA933-8x20	8x20	6.5
BBA933-8x25	8x25	7.5
BBA933-8x30	8x30	7.9
BBA933-8x40	8x40	9.9
BBA933-8x50	8x50	11
BBA933-8x60	8x60	13
BBA933-8x70	8x70	14
BBA933-8x80	8x80	15
BBA933-8x100	8x100	19
BBA933-8x120	8x120	22
BBA933-8x160	8x160	29
BBA933-10x20	10x20	12
BBA933-10x25	10x25	14
BBA933-10x30	10x30	15
BBA933-10x40	10x40	17
BBA933-10x50	10x50	19
BBA933-10x60	10x60	22
BBA933-10x70	10x70	25
BBA933-10x80	10x80	29
BBA933-10x100	10x100	35
BBA933-10x120	10x120	39
BBA933-10x160	10x160	49
BBA933-10x180	10x180	55
BBA933-12x30	12x30	19
BBA933-12x40	12x40	22
BBA933-12x50	12x50	25
BBA933-12x60	12x60	26
BBA933-12x70	12x70	29
BBA933-12x80	12x80	39
BBA933-12x100	12x100	49

Kodi	Permasa (mm)	Çmimi
BBA933-12x120	12x120	55
BBA933-12x160	12x160	79
BBA933-14x30	14x30	29
BBA933-14x40	14x40	39
BBA933-14x50	14x50	45
BBA933-14x60	14x60	49
BBA933-14x70	14x70	55
BBA933-14x80	14x80	59
BBA933-14x100	14x100	69
BBA933-14x200	14x200	110
BBA933-16x30	16x30	43
BBA933-16x40	16x40	44
BBA933-16x50	16x50	45
BBA933-16x60	16x60	55
BBA933-16x70	16x70	65
BBA933-16x80	16x80	85
BBA933-16x100	16x100	89
BBA933-16x160	16x160	139
BBA933-18x50	18x50	69
BBA933-18x60	18x60	89
BBA933-18x70	18x70	95
BBA933-18x80	18x80	99
BBA933-18x100	18x100	150
BBA933-20x50	20x50	95
BBA933-20x60	20x60	99
BBA933-20x70	20x70	110
BBA933-20x80	20x80	139
BBA933-20x90	20x90	145
BBA933-20x100	20x100	169
BBA933-22x50	22x50	110
BBA933-22x60	22x60	120
BBA933-22x70	22x70	150
BBA933-22x80	22x80	159
BBA933-24x50	24x50	130
BBA933-24x60	24x60	150
BBA933-24x70	24x70	155
BBA933-24x80	24x80	160
BBA933-24x90	24x90	190
BBA933-24x100	24x100	220
BBA933-24x120	24x120	290
BBA933-27x100	27x100	220

**DIN 933 10.9**
**BULLONA TE ZI ME FILETIM TE PLOTE**



Kodi	Permasa (mm)	Çmimi
01918	8x30	<b>15</b>
01923	8x50	<b>18</b>
01932	10x40	<b>25</b>
36867	10x70	<b>39</b>
01948	12x30	<b>29</b>
01950	12x40	<b>39</b>

**DIN 7991 10.9**
**BULLONA TE ZI KOKE HEXAGON TE SHESHTE**

Kodi	Permasa (mm)	Çmimi
04189	5x16	<b>2.8</b>
04191	5x20	<b>3.0</b>
04193	5x25	<b>3.5</b>
04195	5x30	<b>5.5</b>
04213	6x20	<b>5.5</b>
04215	6x25	<b>6.5</b>
04239	8x20	<b>9.5</b>
04241	8x25	<b>9.9</b>
NB04241	8x25	<b>10.0</b>
04243	8x30	<b>10.5</b>
04245	8x35	<b>11</b>
04247	8x40	<b>11.5</b>
04261	10x20	<b>16.9</b>
04263	10x25	<b>17.9</b>
04265	10x30	<b>13.9</b>
04267	10x35	<b>16.0</b>
04269	10x40	<b>18.5</b>
04284	12x25	<b>29</b>
04286	12x30	<b>32.0</b>
04288	12x35	<b>36.0</b>
04290	12x40	<b>38.0</b>
04294	12x50	<b>39.0</b>
04306	16x40	<b>75.0</b>
04310	16x50	<b>79.0</b>

**7380 10.9**
**BULLONA TE ZI KOKE HEXAGON TE RRUMBULLAKET**

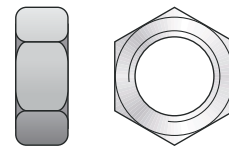
Kodi	Permasa (mm)	Çmimi
04109	6x25	<b>5</b>
04217	6x30	<b>5.5</b>
04110	6x30	<b>5.5</b>
04116	8x12	<b>8.9</b>
04118	8x16	<b>9.5</b>
04119	8x20	<b>9.9</b>
04120	8x25	<b>10.0</b>
04121	8x30	<b>11</b>
04122	8x35	<b>12</b>
04123	8x40	<b>15</b>
04129	10x16	<b>15</b>
04131	10x25	<b>19</b>
04132	10x30	<b>21</b>
04133	10x35	<b>21</b>
04134	10x40	<b>22</b>
04140	12x20	<b>23</b>
04141	12x25	<b>24</b>
04142	12x30	<b>25</b>
04143	12x35	<b>29</b>
04144	12x40	<b>39</b>

**DIN 934 8.8**
**DADO TE ZINGUARA**

Kodi	Permasa (mm)	Çmimi
DB934-5	5 mm	<b>0.7</b>
DB934-6	6 mm	<b>1.0</b>
DB934-8	8 mm	<b>2.0</b>
DB934-10	10 mm	<b>4.0</b>
DB934-12	12 mm	<b>6.0</b>
DB934-14	14 mm	<b>10</b>
DB934-16	16 mm	<b>12</b>
DB934-18	18 mm	<b>19</b>
DB934-20	20 mm	<b>25</b>
DB934-22	22 mm	<b>35</b>
DB934-24	24 mm	<b>49</b>
DB934-27	27 mm	<b>69</b>
DB934-30	30 mm	<b>100</b>

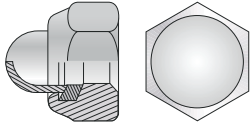

**DIN 1578 8.8**
**DADO E ZINGUAR ME KAPUÇ**

Kodi	Permasa (mm)	Çmimi
DIN1587-6	6 mm	<b>2.0</b>
DIN1587-8	8 mm	<b>3.5</b>
DIN1587-10	10 mm	<b>8.0</b>
DIN1587-12	12 mm	<b>10.0</b>

**DIN 125 A 8.8**
**RONDELE E ZINGUAR**

Kodi	Permasa (mm)	Çmimi
RB125A-5	5 mm	<b>0.3</b>
RB125A-6	6 mm	<b>0.7</b>
RB125A-8	8 mm	<b>1.0</b>
RB125A-10	10 mm	<b>2.0</b>
RB125A-12	12 mm	<b>2.9</b>
RB125A-14	14 mm	<b>4.9</b>
RB125A-16	16 mm	<b>5.5</b>
RB125A-18	18 mm	<b>7.5</b>
RB125A-20	20 mm	<b>8.0</b>
RB125A-22	22 mm	<b>15</b>
RB125A-24	24 mm	<b>16</b>
RB125A-27	27 mm	<b>25</b>
RB125A-30	30 mm	<b>29</b>
RB125A-33	33 mm	<b>45</b>

**DIN 127 B 8.8**
**RONDELE E ÇARE E ZINGUAR**



Kodi	Permasa (mm)	Çmimi
DIN127B-6	6 mm	<b>0.7</b>
DIN127B-8	8 mm	<b>1.0</b>
DIN127B-10	10 mm	<b>1.5</b>
DIN127B-12	12 mm	<b>2.0</b>
DIN127B-14	14 mm	<b>3.5</b>
DIN127B-16	16 mm	<b>5.9</b>

**DIN 985 8.8**
**DADO ME GOMINE**

Kodi	Permasa (mm)	Çmimi
DIN985-6	6 mm	<b>1.9</b>
DIN985-8	8 mm	<b>3.5</b>
DIN985-10	10 mm	<b>6.9</b>
DIN985-12	12 mm	<b>9.0</b>

**DIN 6923 8.8**
**DADO E FREZUAR E ZINGUAR**

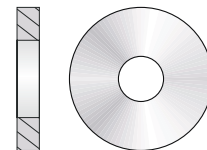
Kodi	Permasa (mm)	Çmimi
DIN6923-6	6 mm	<b>3.2</b>
DIN6923-8	8 mm	<b>5.5</b>
DIN6923-10	10 mm	<b>9.0</b>
DIN6923-12	12 mm	<b>14.0</b>

**DIN 9021 8.8**
**RONDELE E GJERE E ZINGUAR**

Kodi	Permasa (mm)	Çmimi
RB9021-6	6 mm	<b>1.7</b>
RB9021-8	8 mm	<b>3.0</b>
RB9021-10	10 mm	<b>6.5</b>
RB9021-12	12 mm	<b>10</b>
RB9021-14	14 mm	<b>16</b>
RB9021-16	16 mm	<b>19</b>
RB9021-18	18 mm	<b>29</b>
RB9021-20	20 mm	<b>39</b>
RB9021-24	24 mm	<b>59</b>
RB9021-30	30 mm	<b>119</b>

**DM 8.8**
**DADO E GJATE E ZINGUAR**



Kodi	Permasa (mm)	Çmimi
DM-8x20	8x20	<b>12</b>
DM-8x25	8x25	<b>14</b>
DM-8x30	8x30	<b>15</b>
DM-10x30	10x30	<b>19</b>

**PB**
**PRIZHIONER I ZINGUAR DIN 975 8.8**

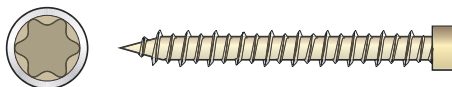
Kodi	Permasa (mm)	Çmimi
PB975-5x1000	5x1000	<b>55</b>
PB975-6x1000	6x1000	<b>69</b>
PB975-8x1000	8x1000	<b>110</b>
PB975-10x1000	10x1000	<b>190</b>
PB975-12x1000	12x1000	<b>250</b>
PB975-14x1000	14x1000	<b>290</b>
PB975-16x1000	16x1000	<b>390</b>
PB975-18x1000	18x1000	<b>590</b>
PB975-20x1000	20x1000	<b>690</b>
PB975-22x1000	22x1000	<b>750</b>
PB975-24x1000	24x1000	<b>950</b>
PB975-27x1000	27x1000	<b>1.200</b>
PB975-30x1000	30x1000	<b>1.690</b>

**VB**
**VIDE BETONI E VERDHE ME KOKE CILINDRIKE**

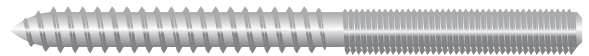
Kodi	Permasa (mm)	Çmimi
VB-52	7.5x52	<b>9.0</b>
VB-60	7.5x60	<b>9.5</b>
VB-62	7.5x62	<b>9.5</b>
VB-80	7.5x80	<b>9.9</b>
VB-92	7.5x92	<b>12</b>
VB-100	7.5x100	<b>14</b>
VB-102	7.5x102	<b>14</b>
VB-120	7.5x120	<b>15</b>
VB-142	7.5x142	<b>16</b>

**PM**
**PRIZHIONER METRIK I ZINGUAR**

Kodi	Permasa (mm)	Çmimi
PM-6x60	6x60 TX 15	<b>2.9</b>
PM-6x70	6x70 TX15	<b>5.5</b>
PM-6x80	6x80 TX15	<b>5.9</b>
PM-8x50	8x50 TX25	<b>6.5</b>
PM-8x60	8x60 TX25	<b>6.9</b>
PM-8x70	8x70 TX25	<b>7.9</b>
PM-8x80	8x80 TX25	<b>10</b>
PM-8x100	8x100 TX25	<b>13</b>
PM-8x120	8x120 TX25	<b>14</b>
PM-8x140	8x140 TX25	<b>17</b>
PM-10x80	10x80 TX25	<b>18</b>
PM-10x100	10x100 TX25	<b>19</b>
PM-10x120	10x120 TX25	<b>22</b>
PM-10x140	10x140 TX25	<b>29</b>
PM-10x180	10x180 TX25	<b>39</b>
PM-12x140	12x140 TX30	<b>39</b>
PM-12x160	12x160 TX30	<b>49</b>

**ST 571 8.8**
**STRIFONI DIN E ZINGUAR**

Kodi	Permasa (mm)	Çmimi
ST-6x40	6x40	<b>4.5</b>
ST-6x60	6x60	<b>6.5</b>
ST-6x80	6x80	<b>7.9</b>
ST-8x50	8x50	<b>9.9</b>
ST-8x60	8x60	<b>12</b>
ST-8x70	8x70	<b>13</b>
ST-8x80	8x80	<b>15</b>
ST-8x90	8x90	<b>16</b>
ST-8x100	8x100	<b>17</b>
ST-8x120	8x120	<b>20</b>
ST-8x140	8x140	<b>22</b>
ST-10x70	10x70	<b>19</b>
ST-10x80	10x80	<b>29</b>
ST-10x90	10x90	<b>32</b>
ST-10x100	10x100	<b>35</b>
ST-10x120	10x120	<b>39</b>
ST-10x140	10x140	<b>45</b>

**FWA**
**UPA METALIKE TE RENDA TE ZINGUARA**



Kodi	Permasa (mm)	Çmimi
FWA-6x60	6x60	15.0
FWA-6x70	6x70	15.5
FWA-6x80	6x80	16.0
FWA-6x90	6x90	17.0
FWA-6x100	6x100	22
FWA-6x120	6x120	23
FWA-8x60	8x60	19
FWA-8x80	8x80	19
FWA-8x90	8x90	22
FWA-8x105	8x105	25
FWA-8x110	8x110	39
FWA-8x120	8x120	29
FWA-8x140	8x140	35
FWA-10x70	10x70	40
FWA-10x80	10x80	45
FWA-10x100	10x100	35
FWA-10x120	10x120	39
FWA-10x140	10x140	45
FWA-10x150	10x150	59
FWA-10x160	10x160	65
FWA-10x180	10x180	69
FWA-12x80	12x80	45
FWA-12x100	12x100	49
FWA-12x120	12x120	55
FWA-12x140	12x140	65
FWA-12x150	12x150	75
FWA-12x180	12x180	85
FWA-12x220	12x220	110
FWA-12x250	12x250	139
FWA-14x100	14x100	99
FWA-14x120	14x120	119
FWA-14x140	14x140	125
FWA-14x160	14x160	125
FWA-14x180	14x180	190
FWA-14x220	14x220	199
FWA-16x110	16x110	119
FWA-16x140	16x140	129
FWA-16x160	16x150	135
FWA-16x180	16x180	150
FWA-16x220	16x220	190
FWA-16x250	16x250	199

**UM**
**UPA METRIKE BRONXI**

Kodi	Permasa (mm)	Çmimi
UM-6x25	6x25	29
UM-8x30	8x30	49
UM-10x35	10x35	79
UM-12x40	12x40	129
UM-14x45	14x45	139

**UZM**
**UPA METRIKE TE ZINGUARA**

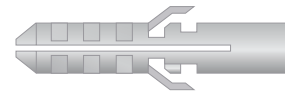
Kodi	Permasa (mm)	Çmimi
UZM-6x30	6x30	8
UZM-8x35	8x35	10
UZM-10x40	10x40	15
UZM-12x52	12x52	33
UZM-16x63	16x63	55

**UPA**
**UPA PLASTIKE**

Kodi	Permasa (mm)	Çmimi
UPA6	6	0.5
UPA8	8	1.3
UPA10	10	1.5
UPA12	12	2.0
UPA14	14	2.0

**UG**
**UPA PLASTIKE + VIDE ME GODITJE**

Kodi	Permasa (mm)	Çmimi
UG-6x40	6x40	3.9
UG-8x100	8x100	6.9
UG-8x120	8x120	10.0
UG-8x140	8x140	12.0



**VP**
**VIDE EXAGON ME MAJE PUNTO**

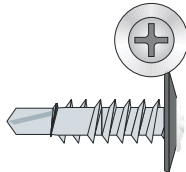

Kodi	Permasa	Sasia	Çmimi
VP-6.3x16	6.3x16	1000	<b>3.9</b>
VP-6.3x19	6.3x19	900	<b>6.5</b>
VP-6.3x25	6.3x25	250	<b>7.9</b>
VP-6.3x32	6.3x32	600	<b>8.5</b>
VP-6.3x38	6.3x38	500	<b>8.9</b>
VP-6.3x50	6.3x50	450	<b>12</b>
VP-6.3x60	6.3x60	500	<b>13</b>
VP-6.3x75	6.3x75	300	<b>14</b>
VP-6.3x100	6.3x100	200	<b>15</b>
VP-6.3x115	6.3x115	175	<b>17</b>
VP-6.3x125	6.3x125	175	<b>19</b>

**VPT**
**VIDE TRUST ME MAJE PUNTO**

Kodi	Permasa	Sasia	Çmimi
VPT-4.2x16	4.2x16	1000	<b>2.2</b>
VPT-4.2x25	4.2x25	700	<b>2.5</b>
VPT-4.2x32	4.2x32	500	<b>2.9</b>
VPT-4.2x41	4.2x41	500	<b>3.2</b>

**UG**
**UPA METALIKE ME GREP**

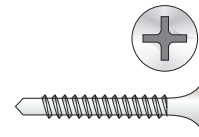
Kodi	Permasa	Çmimi
UG-6x50	6x50	<b>29</b>
UG-8x60	8x60	<b>55</b>
UG-10x70	10x70	<b>75</b>
UG-12x90	12x90	<b>120</b>

**VPF**
**VIDE PHILIPS ME MAJE PUNTO**

Kodi	Permasa	Sasia	Çmimi
VPF-3.5X13	3.5x13	1000	<b>0.5</b>
VPF-3.5x16	3.5x16	1000	<b>0.8</b>
VPF-3.5x19	3.5x19	1000	<b>1.0</b>
VPF-3.5x25	3.5x25	1000	<b>1.3</b>
VPF-4.2x13	4.2x13	4000	<b>1.0</b>
VPF-4.2x16	4.2x16	3000	<b>2.2</b>
VPF-4.2x19	4.2x19	2500	<b>2.5</b>
VPF-4.2x25	4.2x25	1500	<b>2.9</b>
VPF-4.2x32	4.2x32	1000	<b>2.2</b>
VPF-4.2x38	4.2x38	500	<b>2.4</b>
VPF-4.2x45	4.2x45	600	<b>2.6</b>
VPF-4.8x16	4.8x16	1000	<b>0.8</b>
VPF-4.8x19	4.8x19	2000	<b>2.8</b>
VPF-4.8x25	4.8x25	1250	<b>3.0</b>
VPF-4.8x32	4.8x32	1000	<b>3.9</b>
VPF-4.8x38	4.8x38	500	<b>4.5</b>
VPF-4.8x45	4.8x45	500	<b>4.9</b>
VPF-4.8x50	4.8x50	500	<b>5.5</b>

**FI**
**FASHETA INOXI 9 MM**

Kodi	Permasa (mm)	Çmimi
FI-32x50	32-50	<b>35</b>
FI-40x60	40-60	<b>49</b>
FI-100x120	100-120	<b>55</b>

**UC**
**UPA METALIKE UNAZE**

Kodi	Permasa	Çmimi
UC-6X50	6x50	<b>29</b>
UC-8X60	8x60	<b>55</b>
UC-10X70	10x70	<b>75</b>
UC-12X90	12x90	<b>120</b>

**RROTE GOME E LEVIZESHME**

Kodi	Permasa	Paketimi	Çmimi
R21075	75 mm	90	<b>190</b>
R21100	100 mm	36	<b>390</b>
R21125	125 mm	24	<b>450</b>
R21160	160 mm	12	<b>890</b>
R21180	180 mm	8	<b>990</b>
R21200	200 mm	8	<b>1.190</b>
R21250	250 mm	6	<b>1.690</b>

**RROTE GOME STATIKE**

Kodi	Permasa	Paketimi	Çmimi
R22075	75 mm	90	<b>180</b>
R22100	100 mm	36	<b>330</b>
R22125	125 mm	24	<b>390</b>
R22160	160 mm	12	<b>790</b>
R22180	180 mm	8	<b>850</b>
R22200	200 mm	8	<b>990</b>
R22250	250 mm	6	<b>1.290</b>

**RROTE GOME E LEVIZESHME ME FRENIM**

Kodi	Permasa	Paketimi	Çmimi
R23075	75 mm	60	<b>300</b>
R23100	100 mm	30	<b>500</b>
R23125	125 mm	20	<b>650</b>
R23160	160 mm	10	<b>1.190</b>
R23180	180 mm	6	<b>1.250</b>
R23200	200 mm	6	<b>1.490</b>
R23250	250 mm	4	<b>1.790</b>

**RROTE PORTOKALLI E LEVIZESHME**

Kodi	Permasa	Paketimi	Çmimi
R50050	50 mm	100	<b>150</b>
R50075	75 mm	40	<b>300</b>
R50100	100 mm	36	<b>390</b>
R50125	125 mm	30	<b>450</b>

**RROTE PORTOKALLI STATIKE**

Kodi	Permasa	Paketimi	Çmimi
R51050	50 mm	100	<b>150</b>
R51075	75 mm	40	<b>290</b>
R51100	100 mm	30	<b>320</b>
R51125	125 mm	30	<b>350</b>

**RROTE PORTOKALLI E LEVIZESHME ME FRENIM**

Kodi	Permasa	Paketimi	Çmimi
R52050	50 mm	80	<b>190</b>
R52075	75 mm	36	<b>320</b>
R52100	100 mm	30	<b>450</b>
R52125	125 mm	24	<b>590</b>



## FASHETA METALIKE

- Fashetat metalike me vrima per tuba TORK janë projektuar për përdorim në shume fusha, ato janë të njohura, të sakta dhe ekonomike.
- Fashetat përshtatet në mënyrë të përkryer në tubat dhe siguron mbylljen më të mirë ne bashkime.

- Diametri i shtrëngimit dhe numri standard tregohen në produkt
- Montim i lehtë dhe i sigurt me kapakun dhe dizajnin e përmirësuar të vidave
- Vida Philips është e favorshme edhe ndaj Kacavidave të sheshta te cilat jane lehtesishme te perdorshme nga cdo perdorues
- Skaje te lemuara që parandalojnë dëmtimin e zorrës
- Dizajni trekëndor që parandalon shtrembërimin e formës



Kodi	Diametri Ø [mm]	Gjeresia [mm]	Trashësia [mm]	Shtrengimi [Nm]	Paketimi [cope]	Cmimi
HR085W1-008012-101	8-12	8.5	0.60	2.5	1000	<b>14</b>
HR085W1-010016-101	10-16	8.5	0.60	2.5	1000	<b>15</b>
HR085W1-012020-101	12-20	8.5	0.70	4.0	1000	<b>16</b>
HR085W1-016025-101	16-25	8.5	0.70	4.0	1000	<b>18</b>
HR010W1-019026-101	19-26	10	0.80	5.0	1000	<b>19</b>
HR010W1-020032-101	20-32	10	0.80	5.0	1000	<b>21</b>
HR010W1-025040-101	25-40	10	0.80	5.0	700	<b>22</b>
HR010W1-030045-101	30-45	10	0.80	5.0	600	<b>23</b>
HR010W1-032050-101	32-50	10	0.80	5.0	600	<b>24</b>
HR010W1-040060-101	40-60	10	0.80	5.0	400	<b>25</b>
HR010W1-050070-101	50-70	10	0.80	5.0	400	<b>27</b>
HR010W1-060080-101	60-80	10	0.80	5.0	300	<b>29</b>
HR010W1-070090-101	70-90	10	0.80	5.0	100	<b>32</b>
HR010W1-080100-101	80-100	10	0.80	5.0	100	<b>45</b>
HR010W1-100120-101	100-120	10	0.80	5.0	50	<b>62</b>
HR010W1-120140-101	120-140	10	0.80	5.0	50	<b>62</b>
HR010W1-140160-101	140-160	10	0.80	5.0	50	<b>69</b>
HR010W1-160180-101	160-180	10	0.80	5.0	50	<b>105</b>
HR010W1-180200-101	180-200	10	0.80	5.0	25	<b>115</b>
HR010W1-230250-101	230-250	10	0.80	5.0	25	<b>175</b>
HR010W1-250270-101	250-270	10	0.80	5.0	25	<b>185</b>



## FASHETA METALIKE HEAVY-DUTY

- Fashetat metalike TORK Heavy Duty janë të dizajnuara për shtrengime te forta dhe të sakta.
- Fashetat veçanërisht perdoren në zonat ku kërkohet vulosje e saktë për tubat e trasha dhe të përforcuar.
- Skaje te lemuara që parandalojnë dëmtimin e zorrës
- Shtrengim me i forte se fashetat standarte
- Dizajn kompakt i qëndrueshëm
- Montim i shpejtë dhe i lehtë

- Dizajni i tij i thjeshtë siguron instalim të lehtë në zonat e përdorimit.
- Dadoja D ndihmon në reduktimin e forcës së aplikimit në bulon dhe bllokim mekanik
- Forca shtrënguese e balancuar 360 gradë
- Dizajn i qëndrueshëm i salduar nga tre pika



Kodi	Diametri Ø [mm]	Gjeresia [mm]	Buloni	Shtrengimi [Nm]	Paketimi [cope]	Cmimi
AH020W1-037040-01	37-40	23.0	M7x60	20.0	100	<b>180</b>
AH020W1-043047-01	43-47	23.0	M7x60	20.0	100	<b>190</b>
AH020W1-051055-01	51-55	23.0	M7x60	20.0	50	<b>220</b>
AH025W1-073079-01	73-79	28.0	M8x85	25.0	50	<b>350</b>
AH025W1-091097-01	91-97	28.0	M8x85	25.0	50	<b>390</b>
AH025W1-104112-01	104-112	28.0	M8x85	25.0	50	<b>450</b>
AH025W1-121130-01	121-130	28.0	M8x85	25.0	50	<b>450</b>
AH030W1-130140-01	130-140	33.5	M10x112	50.0	25	<b>590</b>
AH030W1-140150-01	140-150	33.5	M10x112	50.0	25	<b>650</b>
AH030W1-150162-01	150-162	33.5	M10x112	50.0	25	<b>690</b>
AH030W1-162174-01	162-174	33.5	M10x112	50.0	25	<b>690</b>
AH030W1-174187-01	174-187	33.5	M10x112	50.0	25	<b>690</b>
AH030W1-187200-01	187-200	33.5	M10x112	50.0	25	<b>690</b>
AH030W1-200213-01	200-213	33.5	M10x112	50.0	25	<b>690</b>

## SHTRENGUESE FASHESTASH METALIKE BUTTERFLY



### Perdorimi:

- Pajisje shtëpiake
- Bujqësi
- Cilindra të mbushura me gaz
- LPG – Autogas Systems

- Sektori i Ndërtimit
- Aplikime mekanike
- Sistemet e Energjisë Diellore
- Sistemet e sinjalizimit

Kodi	Diametri Ø [mm]	Paketimi [cope]	Cmimi
HR085W1-013019-401	8.5	600	<b>30</b>

## FASHETA PLASTIKE TE BARDHA



- Fashetat plastike të kablove Tork prodhohen nga materiali Polyamid 6.6, i cili njihet si plastika më e qëndrueshme.
- Ka fortësi të lartë falë strukturës së saj gjysmë kristallore.
- Këto karakteristika strukturore i bëjnë fashetat plastike Tork më të përshtatshme për t'u përdorur nën ngarkesat e duhura, falë qëndrueshmërisë së tyre shumë të lartë në përkulje dhe tërheqje dhe koeficient të ulët të fërkimit.

Kodi	Gjatesia [mm]	Gjeresia [mm]	Shtrengimi [Kg/f]	Shtrengimi [mm]	Paketimi [cope]	Cmimi
TRK-100-25W	100	25	8	22	100	<b>90</b>
TRK-150-25W	150	25	8	35	100	<b>150</b>
TRK-200-25W	200	25	8	50	100	<b>190</b>
TRK-200-36W	200	36	18	60	100	<b>290</b>
TRK-200-48W	200	48	22	50	100	<b>345</b>
TRK-250-36W	250	36	18	65	100	<b>290</b>
TRK-250-48W	250	48	22	65	100	<b>399</b>
TRK-300-48W	300	48	22	80	100	<b>490</b>
TRK-300-76W	300	76	55	80	100	<b>950</b>
TRK-370-36W	370	36	18	98	100	<b>450</b>
TRK-370-76W	370	76	55	98	100	<b>1.150</b>
TRK-430-48W	430	48	22	120	100	<b>699</b>
TRK-450-76W	450	76	55	120	100	<b>1.290</b>
TRK-550-76W	550	76	55	155	100	<b>1.690</b>

## FASHETA PLASTIKE TE ZEZA



- Fashetat plastike të kablove Tork prodhohen nga materiali Polyamid 6.6, i cili njihet si plastika më e qëndrueshme.
- Ka fortësi të lartë falë strukturës së saj gjysmë kristallore.
- Këto karakteristika strukturore i bëjnë fashetat plastike Tork më të përshtatshme për t'u përdorur nën ngarkesat e duhura, falë qëndrueshmërisë së tyre shumë të lartë në përkulje dhe tërheqje dhe koeficient të ulët të fërkimit.

Kodi	Gjatesia [mm]	Gjeresia [mm]	Shtrengimi [Kg/f]	Shtrengimi [mm]	Paketimi [cope]	Cmimi
TRK-100-25B	100	25	8	22	100	<b>90</b>
TRK-150-25B	150	25	8	35	100	<b>150</b>
TRK-200-25B	200	25	8	50	100	<b>190</b>
TRK-200-36B	200	36	18	60	100	<b>290</b>
TRK-200-48B	200	48	22	50	100	<b>345</b>
TRK-250-36B	250	36	18	65	100	<b>290</b>
TRK-250-48B	250	48	22	65	100	<b>399</b>
TRK-300-48B	300	48	22	80	100	<b>490</b>
TRK-300-76B	300	76	55	80	100	<b>950</b>
TRK-370-36B	370	36	18	98	100	<b>450</b>
TRK-370-48B	370	45	25	98	100	<b>550</b>
TRK-370-76B	370	76	55	98	100	<b>1.150</b>
TRK-430-48B	430	48	22	120	100	<b>699</b>
TRK-450-76B	450	76	55	120	100	<b>1.290</b>
TRK-550-76B	550	76	55	155	100	<b>1.690</b>

73598



Çmimi  
**14.500**

**SER ME FASHETA METALIKE**

Seti 365 cope

73831



Çmimi  
**250**

**SET ME 4 FASHETA METALIKE**

Permasa 8-12 mm

73833



Çmimi  
**250**

**SET ME 4 FASHETA METALIKE**

Permasa 12-22 mm

73835

**FASHETA PLASTIKE TE ZEZA**

**FASHETA PLASTIKE TE ZEZA**



Çmimi  
**250**

**SET ME 4 FASHETA METALIKE**

Permasa 20-32 mm



Kodi	Gjatesia [cm]	Çmimi
73893	150x2.5	<b>150</b>
73894	200x2.5	<b>190</b>



Kodi	Gjatesia [cm]	Çmimi
73895	300x3.6	<b>350</b>
73897	400x4.8	<b>790</b>

**SET ME 50 PERCINA ALUMINI**

**SET ME 50 PERCINA ALUMINI**

04716



Kodi	Gjatesia [mm]	Çmimi
70410	4.0x9.6	<b>90</b>
70420	4.0x12.7	<b>100</b>
70430	4.0x19	<b>120</b>

04714



Kodi	Gjatesia [mm]	Çmimi
70490	4.8x9.6	<b>130</b>
70500	4.8x12.7	<b>140</b>
70510	4.8x19	<b>150</b>

04684



Çmimi  
**690**

**SET ME 100 KUNJA PLLAKASH**

Permasa 1 mm

04100



Çmimi  
**690**

**SET ME 50 KUNJA/50 PYKA PLLAKASH**

Permasa 1 mm



Çmimi  
**1.900**

**PINCE FIKSUESE**

Per kunja pllakash



Çmimi  
**390**

**LAPS PRERES DHE THYES**

Lapsash





### UPA PLASTIKE STANDART

- Prodhuar nga material i cilesise te pare HDPE dhe rezistente ndaj thyerjes dhe palosjes.
- Mbajtje e sigurte ne mure fale struktures me spiranca anesore.
- Per aplikim te sigurte diametri i vrimes duhet te jete mbrenda vlerave te dhena.

Kodi	Permase [mm]	Paketimi [cope]	Cmimi
OR03	8	1000	<b>0.8</b>
OR04	10	500	<b>1.5</b>

### UPA PLASTIKE UNIVERSALE

- Prodhuar nga material i cilesise te pare HDPE dhe rezistente ndaj thyerjes.
- Mbajtje e sigurte ne mure fale struktures me spiranca anesore.
- Vidhosja e upes krijon hapjen e spirancave dhe fiksimin ne mure.

Kodi	Permase [mm]	Paketimi [cope]	Cmimi
OR08	8	500	<b>1.0</b>



### UPE GIPSI KERMILL PLASTIKE

- Montohet direkt ne mure pa shpim paraparak.
- Gjatesia minimale e vides 32 mm.
- I pershtatshem per vida M4.
- Vidhohet me kacavide PH2.
- I pershtatshem per mure gipsi.
- Nuk eshte e pershtatshme ne beton.

Kodi	Permase	Paketimi [cope]	Cmimi
OR21	Vetefiletuese	500	<b>1.5</b>

### UPA PLASTIKE PER MURE TULLE

- Prodhuar nga material i cilesise te pare, upat per mure tulle perdoret ne beton dhe tulla.
- Struktura e vecante e dhembzuar eshte ndertuar per tu fiksuar ne mbrendesi pa efekt rrotullues.
- Perdoret per fiksimin e tubave te gazit dhe instalimeve te tjera ne vende te ndryshme.

Kodi	Permase [mm]	Paketimi [cope]	Cmimi
OR09	8	500	<b>1.8</b>
OR10	10	500	<b>3.0</b>



1  
2  
3  
4  
5  
6  
7  
8  
9  
10



## KRYQE PLLAKASH ME VRIMA TE BARDHA

- Kryqet ofrojnë hapësira të njetrajtshme midis pllakave.
- Ato duhet të hiqen pa u thare plotesisht.
- Prodhimi i tyre me vrima krijon një stabilitet në lenden ngjitëse duke bërë pllaken mos të levizë.

Kodi	Permasa [mm]	Paketimi [cope]	Cmimi
OR49	2	500	<b>0.4</b>
OR22	3	500	<b>0.4</b>



## KUNJA PLLAKASH TE BARDHA

- Për përdorim me të gjitha pllakat e dyshemesë dhe të murit me trashësi 0.6-1.1 cm.
- Konstruksion polimer i qëndrueshëm dhe i sigurt.
- Krijon fuga 1-2 cm dhe mund të përdoret me ndarës tradicionale të pllakave

Kodi	Permasa [mm]	Paketimi [cope]	Cmimi
OR27	1	100	<b>4.5</b>
OR28	2	100	<b>4.5</b>

## PINCE FIKSUESE PLASTIKE PER NIVELIMIN E PLLAKAVE

- E përshtatshme për pllakat deri në 12 mm të trasha
- Siguron edhe fuga 1mm / 2mm (në varësi të kapëses së nivelimit të përdorur)



Kodi	Permasa	Paketimi [cope]	Cmimi
OR32	Nivelim	500	<b>990</b>



## KRYQE PLLAKASH TE BARDHA

- Kryqet ofrojnë hapësira të njetrajtshme midis pllakave.
- Ato duhet të hiqen pa u thare plotesisht.
- Prodhimi i tyre me fiksues rijon një stabilitet në lenden ngjitëse duke bërë pllaken mos të levizë.

Kodi	Permasa [mm]	Paketimi [cope]	Cmimi
OR25	2	500	<b>0.5</b>
OR26	3	500	<b>0.5</b>

(Eko)



(LUX)



## PYKA PLLAKASH

- Krijojnë fuga midis pllakave dhe i mbane ato të niveluara midis tyre.
- Perdoret lehtësisht për të gjitha sipërfaqet e pllakave
- Cmtonohet thjeshtë dhe shpejt.
- Pas tharjes pykat mund të hiqen dhe riperdoren.

Kodi	Ngjyra	Paketimi [cope]	Cmimi
OR30	E kuqe	100	<b>7.5</b>
OR31	E zeze	100	<b>4.9</b>

**E RE**



## PILETE DUSHI INOXI ME VRIMA

Kodi	Permasa [mm]		Cmimi
OR20A	20 cm	Horizontale	<b>790</b>
OR30A	30 cm	Horizontale	<b>890</b>
OR40A	40 cm	Horizontale	<b>1.050</b>
OR50A	50 cm	Horizontale	<b>1.200</b>
OR60A	60 cm	Horizontale	<b>1.350</b>



# SPRAJ TEKNIK DHE NGJITËS ADEZIV

**WD-40**

USE PRODUCT

**SPRAYS 2 WAYS**

**SPRAY** **STREAM**

- Stops Squeaks
- Removes & Protects
- Loosens Rusted Parts
- Frees Sticky Mechanisms
- Drives Out Moisture

NEVER FLAMMABLE. CONTENTS UNDER PRESSURE.  
HARMFUL OR FATAL IF SWALLOWED.  
KEEP OUT OF REACH OF CHILDREN.  
SEE REVERSE SIDE FOR ADDITIONAL PRECAUTIONS ON BACK.

**NET WEIGHT**  
12 OZ./340g





## WD-40 Produkte Multifunktionale



001200120



002400120



003005120



Display Box 200ml



Display Box 400ml



003005120

Kodi	Litër	Paketimi	Cmimi
001200120	Spraj Multifunksional WD-40 200ML	36	550
002400120	Spraj Multifunksional WD-40 400ML	24	950
003005120	Spraj Multifunksional WD-40 5L + Sperkates	1	7.500



## WD-40 SPRAJ MULTIFUNKSIONAL

- Pastron dhe mbron
- Liron pjesët e ndryshkura
- Liron mekanizma te bllokuara
- Eleminon kërcitjet
- Largon lagështinë dhe ujë



Display Box 500 ml



002250120

002500120

Kodi	Litër	Kutitë	CMIMI
002250120	ml 250	12	690
002500120	ml 500	24	990

### Me dopjo SISTEM SPERKATES

.Me një tub të integruar që nuk humbet  
.Për rrjedhje precize ose spërkatje të gjerë  
.I zgjuar, fleksibël, ekonomik në përdorim



RPJEDHJE  
PRECIZE



SPERKATJE  
E GJERE





## PERFORMANCË E LARTË SPRAJ SILIKONI

Përbërja e tij nuk njolloset dhe ofron lubrifikimi të shkëlqyer, nuk tërheq papastërtitë dhe mbron nga lagështia. Aty ku përdoren, pjesët ndalojnë "ngjitjen" dhe është i përshtatshëm për makineri .te presiont të lartë

### :Karakteristikat dhe Përfitimet

- ,Me sistem spërkatjeje të dyfishtë
- Spërkatje e gjerë dhe precize
- ,Ofron lubrifikimin e shkëlqyer të Metaleve
- .Plastikes, gomes & Drurit
- Përbërje speciale për të përmirësuar performanca në kushte presioni të lartë
- Hidroizolon dhe mbron nga lagështia
- Mbron nga ndryshku dhe korrozioni
- .Kudo qe përdoren, pjesët nuk ngjiten
- Nuk njolloset
- Përballon temperaturat nga -35°C deri në +200°C

### :Aplikimet

- rripa, kushineta, dyer & mentesha, vegla, "udhezues",
- .valvola, bravë, ashensorë



N° 145374



Kodi	Litër	Paketimi	Cmimi
201040120	400ml	12	1.190





## SPRAJ TEKNIK KONTAKTI ELEKTRIK

### :Karakteristikat dhe Përfitimet

- Me sistem spërkatjeje të dyfishtë, spërkatje të gjerë dhe precize
- Pastrues jopërçues me veprim të menjëhershëm
- Ideale për pajisje elektrike, kontakte, plastikë dhe gome
- Depërton shpejt dhe nuk lë mbetje
- Depërton në vende të vështira për t'u arritur



N° 145374



Kodi	Litër	PAKETIMI	Cmimi
203040120	Spraj Teknik kontakti elektrik WD-40 400 ML	12	990



## PERFORMANCE E LARTË SPRAJ TEKNIK GRASO LITIUMI

### :Karakteristikat dhe Përfitimet

- Me sistem spërkatjeje të dyfishtë, spërkatje të gjerë dhe precize
- I përshtatshëm për përdorim në aplikime metal me metal
- Mbrojtje afatgjatë kundër ndryshkut dhe korrozioni
- Ideale për aplikime që mbajnë ngarkesë
- Lubrifikant i trashë
- I reziston temperaturave nga -18C deri në +145oC



N° 145374

Kodi	Litër	PAKETIMI	Cmimi
202040120	Spraj Teknik Graso Litiumi WD-40 400 ML	12	1.290



**HQ**  
HIGH QUALITY

**XT10®**  
10 FUNZIONI IN 1

**ME 10  
FUNKSIONE**

1. Zhbllokues
2. Mbrojtes
3. Lubrifikant
4. Rezistent ndaj temperatures
5. Depertues
6. Antikorrezion
7. Kunder grasos
8. Per cdo siperfaqe
9. Fuqi tretese
10. Rezistent ndaj ujit

**LUBRIFIKANT UNIVERSAL  
XT 10 400 ML HQ**



**AMBRO-SOL®**  
MADE IN ITALY

Kodi S159 **590**

**LUBRIFIKANT UNIVERSAL  
XT 10 150 ML HQ**



**AMBRO-SOL®**  
MADE IN ITALY

Kodi S160 **420**

**SPRAY KUNDRA  
NDRYSHKUT 400 ML**



**AMBRO-SOL®**  
MADE IN ITALY

Kodi S152 **420**

**SPRAJ LUCIDUES DHE  
AROMATIZUES KROSKOTI**



**AMBRO-SOL®**  
MADE IN ITALY

Kodi A450 **490**

**SPRAY PER HEQJE AKULLI  
250 ML**



**AMBRO-SOL®**  
MADE IN ITALY

Kodi A455 **450**

**SPRAJ PER NXIRJE DHE  
SHKELQIM GOMASH 400 ML**



**AMBRO-SOL®**  
MADE IN ITALY

Kodi A460 **550**

**PASTRUES FRENASH  
500 ML**



**AMBRO-SOL®**  
MADE IN ITALY

Kodi A462 **550**

**SPRAJ STARTERI 200 ML**



**AMBRO-SOL**  
SPRAY  
 MADE IN ITALY

Kodi A466 **490**

**SPRAJ KARBURATORI 400 ML**



**AMBRO-SOL**  
SPRAY  
 MADE IN ITALY

Kodi A470 **490**

**SPRAJ SHKUME PASTRUES PER SEDILJE MAKINE 400 ML**



**AMBRO-SOL**  
SPRAY  
 MADE IN ITALY

Kodi A471 **550**

**SPRAJ MOTORI 400 ML**



**AMBRO-SOL**  
SPRAY  
 MADE IN ITALY

Kodi A473 **490**

**SPRAJ GRASO UNIVERSALE 400 ML**



**AMBRO-SOL**  
SPRAY  
 MADE IN ITALY

Kodi G001 **490**

**SPRAJ GRASO SILIKONI 400 ML**



**AMBRO-SOL**  
SPRAY  
 MADE IN ITALY

Kodi G002 **650**

**SPRAJ GRASO VASELINE 400 ML**



**AMBRO-SOL**  
SPRAY  
 MADE IN ITALY

Kodi G004 **590**

**SPRAK GRASO BAKRI 400 ML**



**AMBRO-SOL**  
SPRAY  
 MADE IN ITALY

Kodi G006 **750**

**SPRAJ GRASO TEMPERATURE PFTE 400 ML**



**AMBRO-SOL**  
SPRAY  
 MADE IN ITALY

Kodi G007 **699**



**LUBRIFIKANT ZINXHIRASH  
400 ML**



Kodi  
G008

**599**

**SPRAJ GRASO UNIVERSALE  
200 ML**



Kodi  
G009

**450**

**SPRAJ KONTAKTI 400 ML**



Kodi  
M200

**420**

**SPRAJ KONTAKTI 200 ML**



Kodi  
M202

**350**

**SPRAY VASELINE 200 ML**



Kodi  
OL100

**390**

**SPRAY VASELINE 400 ML**

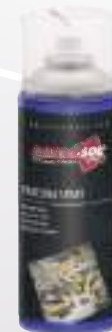

Kodi  
OL101

**590**

**VAJ PER PRERJE SPRAJ  
400 ML**



Kodi  
OL104

**490**

**VAJ LUBRIFIKUES PER ARMET  
400 ML**



Kodi  
OL105

**550**

**SPRAJ PASTRIMI UNIVERSAL  
400 ML**



Kodi  
P300

**420**

**SPRAJ PER HEQJE SILIKONI  
 400 ML**



Kodi P301 **450**

**SOLUCION PASTRUES PER  
 PISTOLETA SHKUME 500 ML**



Kodi P302 **550**

**PASTRUES PLUHRASH ME  
 PRESION TE LARTE 400 ML**



Kodi P303 **550**

**SPRAJ PASTIMI XHAMASH  
 400 ML**



Kodi P313 **450**

**SPRAJ PASTRIMI PER E INOX  
 400 ML**



Kodi P324 **490**

**SPRAJ SALDIMI 400 ML**



Kodi W506 **490**

**SPRAJ SINJALIZUES PER  
 RRJEDHJE GAZI 400 ML**



Kodi W507 **590**

**SPRAJ PER IZOLIME NGA  
 RRJEDHJET E UJIT 500 ML  
 ZEZE**



Kodi M203N **850**

**SPRAJ KUNDRA UJIT PER  
 KEPUCE/XHAKETA 500ML  
 TRANSPARENT**



Kodi OL108 **790**

1  
2  
3  
4  
5  
6  
7  
8  
9  
10

**SPRAJ RUAJTES DRURI  
KUNDRA MOLES 400 ML**



Kodi I276 **650**

**SPRAJ PER HEQJE BOJE  
400 ML**



Kodi I256 **850**

**SPRAJ ZINKU 98% 500 ML**



Kodi Z358 **690**

**LUBRIFIKAT SHKUME  
RRESHKITJE KABUJSH 400ML**



Kodi S156 **490**

**SPRAJ ZINKU 400 ML**



Kodi Z361 **590**

**SODE KAUSTIKE 1 KG**



Kodi P322 **1.100**

**GRASO PER KUZHINETA  
900 GR /  
GRASO  
MULTIFUNKSIONALE 900 GR**



Kodi G016 **2.290**

**PASTE DUARSH ME  
LANOLIN 4000 ML /  
PASTE DUARSH ME  
LANOLIN 1000 ML**



Kodi P308 **1.790**

**SOLUCION ZHBLLOKIMI  
1 LT (1.8 KG)**



Kodi P306 **690**

Kodi G010 **1.690**

Kodi P309 **690**





# SPRAJ BOJE AKRILIK INDUSTRIAL

## Spraj Boje Akrilik

- Është një bojë shumëfunktionale e projektuar për përdorim të brendshëm dhe të jashtëm.

Ajo thahet përafërsisht për 15 minuta pas përdorimit dhe thahet plotësisht rreth 22 orë pas aplikimit.

Mund të përdoret në sipërfaqe të ndryshme duke përfshirë dru, metal, qelq, qeramikë, suvatim



Kodi	Pershkrimi	Cmimi
V4001001	RAL 1001, Spraj boje akrilik Bezhe 400 ml	450
V4001002OP	RAL 1002, Spraj boje akrilik e verdhe mat	450
V4001013	RAL 1013, Spraj boje akrilik i bardhe perle	450
V4001014	RAL 1014, Spraj boje akrilik Fildish	450
V4001015	RAL 1015, Spraj boje akrilik Fildish e hapur	450
V4001016	RAL 1016, Spraj boje akrilik e verdhe Squfuri	450
V4001018	RAL 1018, Spraj boje akrilik Fildish e verdhe zinku	450
V4001023	RAL 1023, Spraj boje akrilik e verdhe trafiku	450
V4002004	RAL 2004, Spraj boje akrilik portokalli	450
V4002009	RAL 2009, Spraj boje akrilik portokalli trafiku	450
V4003001	RAL 3001, Spraj boje akrilik e kuqe sinjali	450
V4003005	RAL 3005, Spraj boje akrilik e kuqe e erret	450
V4003007	RAL 3007, Spraj boje akrilik e kuqe e zeze	450
V4003009	RAL 3009, Spraj boje akrilik vishnje	450
V4003015	Spraj boje akrilik Roze e lehte 400ml	450
V4003020	RAL 3020, Spraj boje akrilik kuqe	450
V4004003	RAL 4003, Spraj boje akrilik roze	450

Kodi	Pershkrimi	Cmimi
V4004005	RAL 4005, Spraj boje akrilik Blu Lilac	450
V4004006	RAL 4006, Spraj boje akrilik Lejla	450
V4005002	RAL 5002, Spraj boje akrilik Blu e thelle	450
V4005003	RAL 5003, Spraj boje akrilik blu safir	450
V4005005	RAL 5005, Spraj boje akrilik blu	450
V4005012	RAL 5012, Spraj boje akrilik blu e lehte	450
V4005015	RAL 5015, Spraj boje akrilik bojeqielli	450
V4005017	RAL 5017, Spraj boje blu e thelle	450
V4005018	RAL 5018, Spaj boje akrilik Blu Oazi	450
V4005022	RAL 5022, Spraj boje akrilik blu e erret	450
V4006001	RAL 6001, Spraj boje akrilik jeshile smeraldi	450
V4006005	RAL 6005, Spraj boje akrilik jeshile myshku	450
V4006018	RAL 6018, Spraj boje akrilik e gjelbert	450
V4006019	RAL 6019, Spraj boje akrilik jeshile e hapur	450
V4006024	RAL 6024, Spraj boje akrilik jeshile trafiku	450
V4006029	RAL 6029, Spraj boje akrilik jeshile mente	450
V4007001	RAL 7001, Spraj boje akrilik Gri Argjendi	450
V4007004	RAL 7004, Spraj boje akrilik gri	450



## SPRAJ BOJE AKRILIK INDUSTRIAL

### Spraj Boje Akrilik

- Është një bojë shumëfunktionale e projektuar për përdorim të brendshëm dhe të jashtëm.

Ajo thahet përafërsisht për 15 minuta pas përdorimit dhe thahet plotësisht rreth 22 orë pas aplikimit.

Mund të përdoret në sipërfaqe të ndryshme duke përfshirë dru, metal, qelq, qeramikë, suvatim



Kodi	Pershkrimi	Cmimi
V4007011	RAL 7011, Spraj boje akrilik Gri Hekuri	450
V4007035	RAL 7035, Spraj boje akrilik gri e lehte	450
V4007038	RAL 7038, Spraj boje akrilik Gri Dritare	450
V4007042	RAL 7042, Spraj boje akrilik Gri e zene	450
V4007048	RAL 7048, Spraj boje akrilik Gri e erret	450
V4008004	RAL 8004, Spraj boje akrilik kafe e hapur	450
V4008012	RAL 8012, Spraj boje akrilik e kuqe kafe	450
V4008014	RAL 8014, Spraj boje akrilik kafe e zene	450
V4008019	RAL 8019, Spraj boje akrilik kafe gri	450
V4009001	RAL 9001, Spraj boje akrilik e bardhe krem	450

Kodi	Pershkrimi	Cmimi
V4009003	RAL 9003, Spraj boje akrilik i bardhe	450
V400PAST.5	RAL 9005, Spraj boje akrilik i zi me shkelqim	450
V400PAST.6	RAL 9005, Spraj boje akrilik e zeze	450
V4009006	RAL 9006, Spraj boje akrilik alumini	450
V4009016	RAL 9016, Spraj boje akrilik e badhe trafiku	450
V400PAST.3	RAL 9010, Spraj boje akrilik e bardhe me shkelqim	450
V400PAST.4	RAL 9010, Spraj boje akrilik e bardhe mat	450
V400PAST.7	RAL 9005 Spraj boje Transparent Varnish me shkelqim	450



## SPRAJ BOJE INDUSTRIAL

### SPRAJ ANTIRUXHO 400 ML

Kodi	Pershkrimi	Cmimi
V400PAST.1/ECO	Primer Antiruxho Gri ECO 400 ml	450
V400PAST.10	Primer Antiruxho i bardhe 400 ml	550



## SPRAJ METALIZATO 400 ML

Kodi	Pershkrimi	Cmimi
V400MET.2	Spraj boje metalizato Gold 400 ml	<b>550</b>
V400MET.3	Spraj boje metalizato Silver 400 ml	<b>590</b>
V400MET.5	Spraj boje Gold pasqyre 400 ml	<b>590</b>



## SPRAJ ZMALTO 400 ML

Kodi	Pershkrimi	Cmimi
V400FLUOR.1	Spraj boje zmalto me efekt fosforeshent Portokalli	<b>650</b>
V400FLUOR.2	Spraj boje zmalto me efekt fosforeshent e Verdhe	<b>650</b>
V400FLUOR.3	Spraj boje zmalto me efekt fosforeshent Roze e thelle	<b>650</b>
V400FLUOR.4	Spraj boje zmalto me efekt fosforeshent jeshil 400 ml	<b>650</b>
V400FLUOR.5	Spraj boje zmalto me efekt fosforeshent Blu	<b>650</b>
V400FLUOR.6	Spraj boje zmalto me efekt fosforeshent e Kuqe	<b>650</b>



## SPRAJ SMALTO ME EFEKT DIAMANTI 400 ML

Kodi	Pershkrimi	Cmimi
V400DIAM.1	Spraj boje Smalto me efekt diamanti Gri 400 ml	<b>590</b>
V400DIAM.2	Spraj boje Smalto me efekt diamanti Blu e erret 400 ml	<b>590</b>
V400DIAM.3	Spraj boje Smalto me efekt diamanti e zeze 400 ml	<b>590</b>
V400DIAM.4	Spraj boje Smalto me efekt diamanti e verdhe 400 ml	<b>590</b>
V400DIAM.5	Spraj boje Smalto me efekt diamanti jeshile 400 ml	<b>590</b>
V400DIAM.6	Spraj boje Smalto me efekt diamanti kuqe 400 ml	<b>590</b>



## SPRAJ BOJE MAKINASH METALIZATO 400 ML

Kodi	Pershkrimi	Cmimi
V400FAS.1	Spraj boje makinash metalizato E Zeze 400 ml	<b>650</b>
V400FAS.2	Spraj boje makinash metalizato Gri e hapur 400 ml	<b>650</b>
V400FAS.3	Spraj boje makinash metalizato Gri e erret 400 ml	<b>650</b>
V400CAR.1	Spraj Antiruxho per disje alumini 400 ml	<b>650</b>





## SPRAJ BOJE SMALTO ME EFEKT ENAMEL



Kodi	Pershkrimi	Cmimi
V400MIC.3	Spraj boje smalto me efekt Enamel Gri me shkelqim 400 ml	<b>590</b>

## SPRAJ BOJE AKRILIK PER ELEKTROSHTETIAKE



Kodi	Pershkrimi	Cmimi
V400RAD.2	RAL 9010, spraj boje akrilik e bardhe e paster	<b>590</b>
V400RAD.2OP	RAL 9010, Spraj boje akrilik E bardhe Opak	<b>590</b>

## SPRAJ TEMPERATURE

Kodi	Pershkrimi	Cmimi
V400TEMP.1	Spraj boje temperature i zi mat 400 ml	<b>590</b>
V400TEMP.2	Spraj boje temperature alumini mat 400 ml	<b>650</b>
V400TEMP.3	Spraj boje temperature i kuq 400 ml	<b>750</b>
V400TEMP.4	Spraj boje temperature i bardhe 400 ml	<b>750</b>
V400TEMP.6	Spraj boje temperature gri 400 ml	<b>750</b>
V400TEMP.8	Spraj boje temperature i kuq 400 ml	<b>850</b>



## SHENJUES METALI

Kodi	Pershkrimi	Cmimi
PENNERO	Shenjues metali i Zi A10 10 ml	<b>490</b>
PENBIANCO	Shenjues metali i Bardhe A10 10 ml	<b>490</b>
PENROSSO	Shenjues metali i Kuq A10 10 ml	<b>490</b>
PENGIALLO	Shenjues metali i Verdhe A10 10 ml	<b>490</b>
PENVERDE	Shenjues metali Jeshil A10 10 ml	<b>490</b>
PENBLU	Shenjues metali Blu A10 10 ml	<b>490</b>
PENARANCIO	Shenjues metali Portokalli A10 10 ml	<b>490</b>

Mund të përdoret në çdo sipërfaqe si:

1. Metal
2. Plastik
3. Xham
4. Gome
- 5 Qeramike



2 mm  
4 mm

# Spraj Industrial

SPRAJ BITUMI TAR&PITCH 500 ML



Kodi  
000173

390

SPRAJ ELEKTRIK 200 ML



Kodi  
000098

290

SPRAJ FRENASH BRAKE CLEANER 500 ML



Kodi  
000012

390

SPRAJ GRASO 500 ML



Kodi  
000067

490

SPRAJ KARBURATORI 500 ML



Kodi  
000043

390

SPRAJ KONTAKTI 500 ML



Kodi  
000128

450

SPRAJ KROSKOTI 200 ML



Kodi  
000272

220

SPRAJ KUNDRA NDRYSHKUT 200 ML



Kodi  
000319

290

SPRAJ KUNDRA NDRYSHKUT 400 ML



Kodi  
000036

450

SPRAJ KUNDRA MYKUT ME SILIKON 400 ML



Kodi  
000203

390

SPRAJ PER NXIRJE GOMASH TYRE SHINER 500 ML



Kodi  
000180

350

SPRAJ SALDIMI 400 ML



Kodi  
000135

390

SPRAJ UNIVERSAL ALL IN ONE 200 ML



Kodi  
000302

350

SPRAJ UNIVERSAL ALL IN ONE 400 ML



Kodi  
000029

490

ZPRAJ ZINKU 400 ML



Kodi  
TAB442

490

## Pasta Universale

SPRAJ PASTRIMI MULTIFUNKSIONAL 500 ML



Kodi  
36114

350

PASTE PASTRIMI MULTI PURPOSE 500 GR



Kodi  
SP0001

250





# Ngjites dhe adeziv

ADEZIV METALI 28 GR/5 MIN



Kodi  
METAL

450

ADEZIV PER PLASTIK MMA 28 GR



Kodi  
047024

450

ADEZIV QERAMIKE 28 GR/5 MIN



Kodi  
EPOXY

450

SILIKON TESTATASH GRI 85 GR



Kodi  
132614

450

SILIKON TESTATASH I KUQ 85 GR



Kodi  
019069

450

SILIKON TESTATASH I ZI 85 GR



Kodi  
132607

450

PASTE NGJITSESE METALI



Kodi  
037018

190

SUPER ATAK MDF 200 ML



Kodi  
2802

390

SUPER ATAK MDF 400 ML



Kodi  
028047

590

# Ngjites dhe adeziv

**BLOKUES DADOSH 50 ML**



Kodi 3243 / **690**

**BLOKUES FILETO PER TESTATA 50 ML**



Kodi 3270 / **690**

**BLOKUES HIDRAULIK 50 ML**



Kodi 3542 / **690**

**BLOKUES NXEHTESE PER FILETO 50 ML**



Kodi 3272 / **690**

**BLOKUES VIDASH 50 ML**



Kodi 3222 / **690**

**NGJITES EMERGJENCE I SILIKONIZUAR, REZISTENT NDAJ NXEHTESE**



Kodi ZE0010001 / **890**

**PASTE SHKELQYESE PER METAL - 50 GR**



Kodi 047048 / **350**

**ADEZIV PER TUBA PVC 125 GR**



Kodi 025565 / **290**

**ADEZIV PER TUBA PVC 50 GR**



Kodi 025527 / **150**

# SILIKON NGJITËS

## Selsil®

### SILIKON SANITAR TRANSPARENT

Selsil Fire Sealant është i bazuar në silikat natriumi dhe me formulimin e tij të veçantë është rezistent deri në 1500 °C. Është projektuar posaçërisht për vulosjen dhe montimin e sobave, vendeve të zjarrit, furrave, barbekujuve dhe ngrohësve.

#### KARAKTERISTIKAT

- Tharje e shpejte.
- Nuk krijon plasaritje
- Aplikohet me pistolete silikoni
- Nuk permban tretes
- Nuk permban ere

Kodi	Pershkrimi	Pesha	Ngjyra	Cmimi
43030	Sanitar	280 ml	Transparent	<b>250</b>



### SILIKON MBUSHES ACRILIK

Per mbushjen e fugës ndërmjet elementit të konstruksionit parafabrikat, mobilje druri, PVC, hekur dhe alumini, fugat në punime guri, druri, betoni, suvaje dhe tullash etj.

Izolimin e kornizave të dritares dhe derës me murin.

#### KARAKTERISTIKAT

- 1 komponent
- Aplikim i lehte me pistolete silikoni
- Formon nje shtrese rezistente ndaj ujit
- Mund te lyhet
- Rezistent ndaj kushteve te motit
- Nuk ndryshon vellimin
- Elasticitet i perhershem
- Rezistent ndaj ujit, eres ne kornizat e aluminit, drurit, PVC

Kodi	Pershkrimi	Pesha	Ngjyra	Cmimi
3050	Silikon mbushes	516 gr	E bardhe	<b>120</b>



### SILIKON MBUSHES ACRILIK NGJITES I SILIKONIZUAR

Sealant akrilik i silikonizuar Selsil përdoret për PVC, montim panelesh alumini dhe druri, fugandërmjet kornizave të dyerve/dritareve dhe murit, fuga në lavaman, vaskë, dollapë, pllaka dhe qeramikë, çarje në mure, dru, suva, alumini dhe tulla.

#### KARAKTERISTIKAT

- 1 komponent
- Aplikim i lehte me pistolete silikoni
- Formon nje shtrese rezistente ndaj ujit
- Mund te lyhet
- Rezistent ndaj kushteve te motit
- Nuk ndryshon vellimin
- Elasticitet i perhershem
- Rezistent ndaj ujit, eres ne kornizat e aluminit, drurit, PVC

Kodi	Pershkrimi	Pesha	Ngjyra	Cmimi
32367	Silikon mbushes	450 gr	E bardhe	<b>120</b>







## SILIKON UNIVERSAL MULTI-PURPOSE

Ngjitës silikoni universal Selsil është ngjitës silikoni me një komponent që trajton lagështinë. Ngjitje e shkëlqyer me një sërë nënshtresash jo poroze si p.sh. alumini, xhami, pllaka qeramike.

### KARAKTERISTIKAT

- 1 komponent
- Aplikim i lehtë me pistolette silikoni
- Tharje në efektin e ajrit
- Rezistent ndaj mykut
- Ngjitje e shkëlqyer në materiale jo poroze
- Elasticitet i perhershëm



Kodi	Pershkrimi	Pesha	Ngjyra	Cmimi
9089246	Silikon universal	280 ml	E zeze	<b>250</b>
8939158	Silikon universal	280 ml	Transparente	<b>250</b>
8921555	Silikon universal	280 ml	E bardhe	<b>250</b>



## SILIKON PER KABINA DUSHI

Silikoni i llamarines PU 50 është një material ngjitës me bazë poliuretani, me një përbërës që izolon lagështinë. Është i aftë të ngjitet në materiale ndërtimi me bazë çimento, tulla, qeramikë, mermer, qelq, dru, çeliku të galvanizuar, alumini dhe shumicën e sipërfaqeve plastike. Përdoret për ngjitjen e mbulesave të catise

### KARAKTERISTIKAT

- 1 komponent
- Aplikim i lehtë me pistolette silikoni
- Tharje në efektin e ajrit
- për përdorim të brendshëm dhe të jashtëm
- Nuk ndryshon vëllimin
- Elasticitet i perhershëm



Kodi	Pershkrimi	Pesha	Ngjyra	Cmimi
024308	Silikon për kabina dushi	310 ml	Transparent	<b>490</b>



## SILIKON NGJITES MONTIMI LIQUID NAIL

Selsil Liquid Nail është ngjitës akrilik me një komponent. Fiksimi i dërrasave prej druri ose UPVc,

Fiksimi i pragjeve, paneleve, pllakave qeramike dhe kornizave zbkuruese mbi nënshtresa të ndryshme si mur, beton, pllaka gipsi dhe druri.

Dhe është gjithashtu i përshtatshëm për ngjitjen e polisterolit ose pllakave.

### KARAKTERISTIKAT

- 1 komponent
- Aplikim i lehtë me pistolette silikoni
- Tharje në efektin e ajrit
- Krijon shtresë për mbrojtjen nga uji
- Mund ta lyeni

Kodi	Pershkrimi	Pesha	Ngjyra	Cmimi
0255K	Silikon montimi	300 ml	E bardhe	<b>190</b>



## SILIKON KUNDER ZJARRIT 1500 °C

Selsil Fire Sealant është i bazuar në silikat natriumi dhe me formulimin e tij të veçantë është rezistent deri në 1500 °C. Është projektuar posaçërisht për vulosjen dhe montimin e sobave, vendeve të zjarrit, furrave, barbekjuve dhe ngrohësve.

### KARAKTERISTIKAT

- Tharje e shpejte.
- Nuk krijon plasaritje
- Aplikohet me pistolette silikoni
- Nuk përmban tretës
- Nuk përmban ere



Kodi	Pershkrimi	Pesha	Ngjyra	Cmimi
030095	Silikon kundër zjarrit	300 ml	E zeze	<b>550</b>



### SILIKON LLAMARINE 50 SHORE

Silikoni i llamarines PU 50 është një material ngjitës me bazë poliuretani, me një përbërës që izolon lagështinë. Është i aftë të ngjitet në materiale ndërtimi me bazë çimento, tulla, qeramikë, mermer, qelq, dru, çeliku të galvanizuar, alumin dhe shumicën e sipërfaqeve plastike. Perdoret për ngjitjen e mbulesave të catise



#### KARAKTERISTIKAT

- 1 komponent
- Aplikim i lehtë me pistoletë silikoni
- Tharje në efektin e ajrit
- për përdorim të brendshëm dhe të jashtëm
- Nuk ndryshon vëllimin
- Elasticitet i përherëshëm

Kodi	Pershkrimi	Pesha	Ngjyra	Cmimi
5017114	Silikon llamarine	300 ml	E zeze	<b>550</b>
5017118	Silikon llamarine	300 ml	Gri	<b>550</b>
5017120	Silikon llamarine	300 ml	E bardhe	<b>550</b>



### SHKUME PER MBUSHJE

Shkume me 1 komponent poliuretan. Ideale për tu përdorur pa pistoletë dhe të pershtatshme për montime apo mbushje të hapësirave boshe. Tundeni para se të përdoren.

#### KARAKTERISTIKAT

- 1 komponent
- Aplikim i lehtë
- Tharje në efektin e ajrit
- Nuk duhet të ekspozohet ndaj rrezeve UV
- Mund ta lyeni
- Fryrje e njetrajtshme

Kodi	Pershkrimi	Pesha	Ngjyra	Cmimi
26326	Shkume për mbushje	500 ml	E bardhe	<b>350</b>
2635	Shkume për mbushje	750 ml	E bardhe	<b>550</b>



Shkuma me mbushje Low Expansion Selsil është projektuar për një të gjerë gamën e aplikimeve të ndërtimit; montimi, vulosja, mbushje dhe izoluese. Formula e presionit të ulët parandalon lakimi i kornizave të dritareve. Për fiksimin e dyerve, dritareve dhe kornizave të dyerve, përmeshja e vrimave dhe çarjeve dhe për të izoluar të nxehtë dhe tubacionet e ujit të ftohtë.

#### KARAKTERISTIKAT

- 1 komponent
- Izolim termik dhe akustik
- Mund ta lyeni mbas tharjes
- Kapacitet i ulët fryrje
- Aplikohet me pistoletë
- Nuk krijon bllokime në afate të shkurtra
- Fryrje e njetrajtshme
- Tharje në efektin e ajrit

Kodi	Pershkrimi	Pesha	Ngjyra	Cmimi
43894	Shkume për mbushje	750 ml	I bardhe	<b>650</b>



### SHKUME PER MBUSHJE KUNDRA NXEHTESISE

Shkuma rezistente ndaj nxehtësise Selsil (Manuale) është meshkumë poliuretani vetë-zgjerruese që përmbajnë lëndë shtytëse që janë krejtësisht të padëmshme tek shtresa e ozonit. Ideale ku ka një rezistencë të lartë, duke garantuar rezistencë ndaj flakës deri në 240 minuta (B1)

#### KARAKTERISTIKAT

- Të gjitha aplikimet me veti rezistente ndaj nxehtësise
- Montimi i dritareve, mbushja dhe vulosja ehapësira boshe, nyje dhe zgavra.
- Mbushja e vrimave në mure.
- Termoizolim në ndërtim i kulmeve, mbyllja e kablove dhe e tubacioneve, lidhja e materialeve izoluese.
- Me shumë qëllime, ngjitje dhe fiksime.

Kodi	Pershkrimi	Pesha	Ngjyra	Cmimi
34907	Shkume për mbushje	750 ml/900 gr	I bardhe	<b>750</b>



## SHKUME PER MBUSHJE KUNDRA NXEHITESISE ME PISTOLETE

Shkuma rezistente ndaj nxehtesise Selsil është shkumë poliuretani vetë-zgjerues që përmban shtytës që janë plotësisht të padëmshëm përshtresa e ozonit. Ofron rezistencë ndaj zjarrit, duke garantuar rezistente ndaj flakës deri në 240 minuta (B1)

### KARAKTERISTIKAT

- Montimi i dritareve, mbushja dhe mbyllja e boshllëqeve hapësirat, nyjet dhe zgavrat.
- Mbushja e vrimave në mure.
- Termoizolim në ndërtim e kulmeve, mbyllja e kabllove dhe tubacioneve, lidhja e materiale izoluese.
- Me shumë qëllime, ngjitje dhe fiksime.



Kodi	Pershkrimi	Pesha	Ngjyra	Cmimi
34908	Shkume per mbushje	750 ml/900 gr	I bardhe	<b>790</b>



## SHKUME PER MBUSHJE LOW EXPASION

Shkume me 1 komponent poliurethan. Perdorim me pistolette dhe e pershtatshme per montime apo mbushje te hapësirave boshe. Mbas tharjes krijon nje vellim te ulet por nje ngjitje te shkelqyer. Ideale per montimin dhe izilomin e dritareve dhe kornizave të dverve, mbushjen e hapësirave, Izolim termik dhe akustik.

### KARAKTERISTIKAT

- 1 komponent
- Izolim termik dhe akustik
- Mund ta lyeni mbas tharjes
- Kapacitet i ulet fryrje
- Aplikohet me pistolette
- Nuk krijon bllokime ne afate te shkurtra
- Fryrje e njetrajshme
- Tharje ne efektin e ajrit



Kodi	Pershkrimi	Pesha	Ngjyra	Cmimi
029839	Shkume per mbushje	750 ml	I bardhe	<b>690</b>



## SHKUME PER MBUSHJE

Shkume me 1 komponent poliurethan. Ideale per tu perdorur me pistolette e pershtatshme per montimin dhe izilomin e dritareve, kornizave të dverve, mbushjen e hapësirave,

### KARAKTERISTIKAT

- 1 komponent
- Aplikim i lehte
- Tharje ne efektin e ajrit
- Nuk duhet te ekspozohet ndaj rrezeve UV
- Mund ta lyeni
- Fryrje e njetrajshme



Kodi	Pershkrimi	Pesha	Ngjyra	Cmimi
2644	Shkume per mbushje	750 ml	E bardhe	<b>590</b>

## SOLUCION PER PASTRIMIN E PISTOLETAVE TE SHKUMES

Solucioni i pastrimit pastron mbetjet e shumës dhe parandalon bllokimin e saj ne maje. Perdorimi eshte i thjeshte, filetoni pistoletin ne pastruesin dhe mbajeni shtypur deri ne momentin qe nuk do te kete me mbetje ne pistolette. Shmang kontaktin me syte dhe lekurenduke perdorur masat e duhura mbrojtese

### KARAKTERISTIKAT

- Aplikim i lehte me pistoleten e shkumes
- Perdoreni menjehere pas perdorimit te shkumes
- Ruajeni ne vend te fresket
- Heq yndyren
- Pastrim ekstrem



Kodi	Pershkrimi	Pesha	Ngjyra	Cmimi
026425	Solucion pastrues	500 ml	Transparente	<b>490</b>





# Injeksion kimik

## INJEKSION KIMIK ME BAZE EPOXY



Sistemi i injeksionit kimik me bazë epokside akrilate me dy komponentë, i përbërë nga rrëshirë dhe ngurtësues. Produkti përdoret në punimet e mbjelljes së upave për mure betoni. Krijim e nje blloku te ngurtësuar per montim dhe mbajtjen e peshave te larta.

### KARAKTERISTIKAT

- Tharje e shpejte.
- Pa rrjedhje
- Aplikohet me pistolete injeksioni
- Ngjyra mbetet konstante
- Temperatura e aplikimit 5 °C -35 °C



Kodi	Pershkrimi	Pesha	Ngjyra	Cmimi
040315	Injeksion kimik	300 ml	A-jeshile B-e zeze	<b>690</b>

## INJEKSION KIMIK ME BAZE POLIESTER



Sistemi i injeksionit kimik me bazë epokside akrilate me dy komponentë, i përbërë nga rrëshirë dhe ngurtësues. Produkti përdoret në punimet e mbjelljes së upave për mure betoni. Krijim e nje blloku te ngurtësuar per montim dhe mbajtjen e peshave te larta.

### KARAKTERISTIKAT

- Tharje e shpejte.
- Pa rrjedhje
- Aplikohet me pistolete injeksioni
- Ngjyra mbetet konstante
- Temperatura e aplikimit 5 °C -35 °C



Kodi	Pershkrimi	Pesha	Ngjyra	Cmimi
040322	Injeksion kimik	300 ml	A-jeshile B-e zeze	<b>590</b>

## INJEKSION KIMIK TEKAFIX PE-1



Ngjitës poliesteri me dy përbërës që përdoret për fiksimin e upave me ngarkesa të rënda dhe mesatare në gur, beton, dhe tulla. Gjithashtu i përshtatshëm si ngjitës për strukturat prej druri dhe metali, kllapa, gardhe, lidhje sanitare, tubacione. Mund të injektohet lehtësisht. Nuk pikon. Forcohet shpejt. I pajisur me dy pipza injektimi.



Kodi	Pershkrimi	Pesha	Ngjyra	Cmimi
163439	Injeksion kimik	300 ml	A-jeshile B-e zeze	<b>790</b>



## HYPERSEAL®-EXPERT-150

HYPERSEAL®-EXPERT-150 është një ngjitës poliuretani i ri per fuga me zgjerim me modul të ulët.

**Karakteristikat:** Një komponent, i formuluar veçanërisht për të siguruar ngjitje pa flluska edhe në kushte klimatike me temperaturë dhe lagështi shumë të lartë dhe rrezeve UV.

**Vetitë:** Tixotropik me nje elasticitet të lëvizjes dhe ngjitje të shkëlqyer në nshtrësia si p.sh. qelqi, alumini, çeliku, polikarbonati etj.

### Përdorimi:

- Panele betoni për zgjerim,
- aplikime për dysheme,
- punime me tulla dhe blloqe,
- pishina,
- korniza metalike,
- dritare dhe panele alumini,
- kanale vaditëse,
- xham
- granit,
- mermer

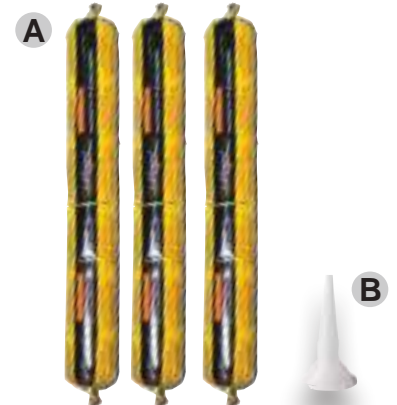

Kodi	Ngjyra	Cmimi
330.007.615.700	I bardhe (A)	<b>650</b>
330.008.615.700	I zi (A)	<b>650</b>
330.012.615.700	Kaf (A)	<b>650</b>
330.115.615.700	Bezhe (A)	<b>650</b>
330.740.615.700	Gri (A)	<b>650</b>
901.010.005	Pipa per silikon sallam 600cc (B)	<b>30</b>

## HYPERDESMO®-CLASSIC

HYPERDESMO®-CLASSIC I BARDHE 1kg / 02.007.001.700

Hidroizolues HYPERDESMO-CLASSIC I bardhe ( 1 KG)

Është një lëng poliuretani me një përbërës I gatshëm per përdorim.

**Karakteristikat:** Me viskozitet të ulët, i cili shërohet me lagështinë në atmosferë për të prodhuar një membranë hidroizoluese shumë elastike me ngjitje të fortë në shumë lloje sipërfaqesh. Ka nje bazë rrëshire të pastër poliuretani hidrofobike elastomerike plus mbushës të veçantë inorganik, të cilët rezultojnë në veti të shkëlqyera të rezistencës mekanike, kimike, termike, UV dhe elementeve natyrore.

### Përdorimi:

- Mbrojtja e pllakave të gipsit dhe çimentos
- Hidroizolim i pllakave (nën)
- Izolimi i tualeteve
- Hidroizolimi i çatisë
- Hidroizolim i çatisë së lehtë prej metali ose çimentoje
- Ne siperfaqet e sheshta te parkimeve
- Mund te hollohet vetem me tretesin 660.002.004.700 SOLVENT-01 (4KG)
- Shoqërohet me Astarin Microsealar – 50 (5LT) 531.002.005.700



HYPERDESMO®-CLASSIC 6kg / 101.007.006.700

HYPERDESMO-CLASSIC I bardhe (25 KG) / 101.007.025.700

Çmimi

**4.990**

Çmimi

**13.500**

## HYPERDESMO®-LV

### Hidroizolues HYPERDESMO-LV I bardhe ( 1 KG) Me viskozitet te Ulet / 102.007.001.700

HYPERDESMO®-LV 1kg HYPERDESMO®-LV është një leng poliuretani me viskozitet shume të ulët .

**Karakteristikat:** Me viskozitet të ulët, i cili shërohet me lagështinë në atmosferë për të prodhuar një membranë hidroizoluese shumë elastike me ngjitje të fortë në shumë lloje sipërfaqesh.

Ka nje bazë rrëshire të pastër poliuretani hidrofobike elastomerike plus mbushës të veçantë inorganik, të cilët rezultojnë në veti të shkëlqyera të rezistencës mekanike, kimike, termike, UV dhe elementeve natyrore.

#### Perdorimi:

- Mbrojtja e pllakave të gipsit dhe çimentos
- Hidroizolim i pllakave
- Izolimi i tualeteve
- Hidroizolimi i çatisë
- Hidroizolim i çatisë së

lehtë prej metali ose çimentoje

- Mund te hollohet vetem me tretesin 660.002.004.700

SOLVENT-01 (4KG)

- Shoqerohet me Astarin Microsealar

– 50 (4LT) 531.002.004.700

Konsumi minimal 1.5-1.8 kg/m2.

Çmimi

**1.190**



HYPERDESMO® LV 1kg / 102.007.001.700

## MICROSEALER

### Astar MICROSEALER - 50 (4LT) Transparent / 531.002.004.700

MICROSEALER-50 është një astar/izolues betoni me bazë poliuretani për nënshtresa poroze dhe jo poroze.

**Karakteristikat:** Një komponent i vetëm, transparent me viskozitet shumë të ulët, depërtim i thellë, shërim i ngadaltë (ditën tjetër) abetare, e cila ka lagështim, ngopje dhe ngjyrosje të shkëlqyer me kalimin e kohës në nënshtresa të ndryshme, qoftë me porozitet të lartë apo të ulët.

Vetite: Mbyllja dhe stabilizimi i nënshtresës, duke siguruar ngjitje të mirë të shtresës kryesore.

#### Perdorimi:

- Beton,
- beton i lagësht
- metal/çelik
- Pllaka qeramike poroze
- pllaka gipsi
- Shoqerohet me Astarin Microsealar

– 50 (4LT) 531.002.004.700

Çmimi

**4.990**



Konsumi 0.200 – 0.500 kg / m2.  
Astar MICROSEALER - 50 (4LT) / 531.002.004.700

## SOLVENT

### Hollues SOLVENT-01 (4KG) / 660.002.004.700

SOLVENT 01 është një tretës i projektuar posaçërisht për hollimin e produkteve

hidroizoluese prej poliuretani si Hyperdesmo.

- Shoqerohet me Hidroizolues HYPERDESMO-CLASSIC I bardhe ( 6 KG) 101.007.006.700
- Shoqerohet me Hidroizolues HYPERDESMO-CLASSIC I bardhe (25 KG) 101.007.025.700

- Transparent

Çmimi

**3.500**



Konsumi 2 kg Hollues Solvent / 25 KG Hyperdesmo  
Hollues SOLVENT-01 (4KG) / 660.002.004.700



## MICROPRIMER-PU

### Astar Silikoni Primer PU Transparent 1LT / 519.002.001.700

MICROPRIMER-PU është një astar/izolues betoni me bazë poliuretani plotësisht alifatik dhe pa zverdhje, si për nënshtresat poroze ashtu edhe për ato jo poroze.

Karakteristikat: Një komponent me viskozitet të ulët dhe shpejtësi të balancuar të ngurtësimit, të cilat rezultojnë në lagështim të shkëlqyer, lysterje me kalimin e kohës në nënshtresa të ndryshme, me porozitet të lartë apo të ulët.

**Vetitë:** Alifatike dhe pa-ngjyrë.

**Përdorimi:** Primer për ngjitesit HYPERSEAL kur është i nevojshëm një astar pa ngjyrosje. Gjithashtu i përshtatshëm për :

- pllaka betoni,
- metali/çeliku,
- qeramike poroze.
- Primer edhe për veshje transparente PU mbi Pllakat poroze.
- Shoqerohet me produktet Hyperdesmo 1kg , 6kg dhe 25 kg.

Çmimi

**1.390**



Astar Silikoni Primer PU Transparent 1LT / 519.002.001.700

## ADY 500

### Hyperdesmo ADY 500 Mbulese Hidroizoluese nga rrezet UV e Bardhe 1kg / 250.007.001.700

HYPERDESMO®-ADY 500 është një shtresë e sipërme plotësisht alifatike me bazë poliuretani për hidroizoluesit e hyperdesmo.

Karakteristikat: Një përbërës, e bardhe, plotësisht alifatik, nuk zverdhet me kalimin e kohës.

**Vetite:** Fuqi të shkëlqyera fshehëse dhe veti të shkëlqyera kundra rrezeve UV, mekanike dhe kimike.

**Përdorimi:**

- Si mbulese sipër produkteve HYPERDESMO.
- Shoqerohet me produktet Hyperdesmo 1kg , 6kg dhe 25 kg.

Çmimi

**1.990**



Konsumi 0.200 – 0.500 kg / m2.

Hyperdesmo ADY 500 / 250.007.001.700

## AQUASMART AFROS

### AQUASMART AFROS 1LT Polyretan I gatshem per perdorim / 462.002.001.700

Aquasmart Afros është një shtresë hibride alifatike poliuretani me bazë uji, tharje shumë e shpejtë për hidroizolim dhe mbrojtje. Mund të përdoret si solucion 1 komponent I gatshem për ngjitime ose si perforcues.

**Vetitë:**

- Me bazë uji
- Tharje shumë e shpejtë
- Lehtë për tu aplikuar dhe riparuar.
- Tixotropik
- Elastik
- Rezistent ndaj UV
- Super rezistent ndaj Ujit

Çmimi

**990**



AQUASMART AFROS 1LT / 462.002.001.700



Kodi: 158712  
**TEKAPUR SHKUMË  
 PËR MBUSHJE ME  
 PISTOLETË**

☞ 600 ml

Shkumë poliuretani e dizenuar për instalim të shpejtë dhe të lehtë të dritareve dhe dyerve, për mbushjen e plasaritjeve dhe për izolim. Aplikohet duke përdorur pistoletë montuese. Përdoret me lagështi ajri. Aplikimi i saktë i shkumës lejon punë më të shpejtë dhe konsum ekonomik. Shkuma e ngurtësuar siguron një lidhje të fortë dhe veti të shkëlqyera izoluese. Sigurohuni që shkuma të mbrohet nga rrezatimi UV pas përfundimit të punës.

**Koha e tharjes:**

1.5-5 orë

**Koha e ngjitjes:**

5-10 min

Pas aplikimit zgjerohet 2-3 herë në vëllim.



Çmimi

**550**



- 1
- 2
- 3
- 4
- 5
- 6
- 7
- 8
- 9
- 10

## TEKAPUR SHKUMË PËR MBUSHJE

☞ 600 ml

**Kodi: 158711**

Shkumë poliuretani e dizenuar për instalim të shpejtë dhe të lehtë të dritareve dhe dyerve, për mbushjen e plasaritjeve dhe për izolim. Aplikohet duke përdorur pistoletë montuese. Përdoret me lagështi ajri. Aplikimi i saktë i shkumës lejon punë më të shpejtë dhe konsum ekonomik. Shkuma e ngurtësuar siguron një lidhje të fortë dhe veti të shkëlqyera izoluese. Sigurohuni që shkuma të mbrohet nga rrezatimi UV pas përfundimit të punës.

**Koha e tharjes:**

1.5-5 orë

**Koha e ngjitjes:**

5-10 min

Pas aplikimit zgjerohet 2-3 herë në vëllim.

Çmimi

**450**



## SHKUMË ME ZGJERIM TË ULËT ME PISTOLETË PËR DYER DHE DRITARE

☞ 750 ml

**Kodi: 158709**

Shkumë poliuretani me një komponent me zgjerim të ulët për instalimin e dritareve dhe dyerve dhe mbushjen e hapjeve. Për montim të shpejtë të kornizave të dritareve dhe dyerve për ngjitjen dhe fiksimin e materialeve të ndryshme të ndërtimit si: shkallët prej druri, pragjet e dritareve etj.



**Koha e tharjes:**

1.5-5 orë

**Koha e ngjitjes:**

5-10 min

Me zgjerim të ulët pas aplikimit.

Çmimi

**790**



## TEKAPUR SHKUMË PËR MBUSHJE DHE IZOLIME PU FIX

☞ 750 ml

**Kodi: 158702**

Ngjitës poliuretani me një përbërë, është projektuar posaçërisht për ngjitjen e paneleve termoizoluese (polistireni, lesh guri, poliuretani) në sipërfaqet e ndërtesave. Ngurtësohet me lagështinë atmosferike. Është rezistent ndaj plakjes. Aplikimi i saktë dhe forcimi i shpejtë i ngjitësit mundësojnë kryerjen më të shpejtë të punimeve përfundimtare dhe konsum.

**Koha e tharjes:**

1.5-2 orë

**Koha e ngjitjes:**

6-12 min

Me zgjerim të ulët pas aplikimit.

Çmimi

**850**



## TEKAPUR SHKUMË PËR MBUSHJE DHE IZOLIME ME PISTOLETË PU FIX

☞ 750 ml

**Kodi: 158703**

Ngjitës poliuretani me një përbërë, është projektuar posaçërisht për ngjitjen e paneleve termoizoluese (polistireni, lesh guri, poliuretani) në sipërfaqet e ndërtesave. Ngurtësohet me lagështinë atmosferike. Është rezistent ndaj plakjes. Aplikimi i saktë dhe forcimi i shpejtë i ngjitësit mundësojnë kryerjen më të shpejtë të punimeve përfundimtare dhe konsum më të ulët se sa me ngjitësit e çimentos.



**Koha e tharjes:**

1.5-2 orë

**Koha e ngjitjes:**

6-12 min

Me zgjerim të ulët pas aplikimit.

Çmimi

**880**



## TEKAPUR SHKUMË PËR MBUSHJE DHE IZOLIME PËR TJEGULLA PU FIX

☞ 750 ml

**Kodi: 158660**

Ngjitës poliuretani me një përbërës, është projektuar posaçërisht për ngjitjen dhe fiksimin e tjegullave të çatisë në nënshtresën e çatisë. Është një alternativë më e thjeshtë, më e lirë dhe më e besueshme ndaj llaçeve dhe ngjitësve klasikë.

**Koha e tharjes:**

1.5-5 orë

**Koha e ngjitjes:**

5-10 min

Me zgjerim të ulët pas aplikimit.

Çmimi

**950**



## TEKAPUR SHKUMË ME ZGJERIM TË ULËT NGJITJE E SHPEJTË PU FIX

☞ 750 ml

**Kodi: 159768**

Shkumë poliuretani me një komponent me zgjerim të ulët për instalimin e dritareve dhe dyerve dhe mbushjen e hapjeve. Për montim të shpejtë të kornizave të dritareve dhe dyerve për ngjitjen dhe fiksimin e materialeve të ndryshme të ndërtimit si: shkallët prej druri, pragjet e dritareve etj.



**Koha e tharjes:**

1.5-2 orë

**Koha e ngjitjes:**

6-12 min

Me zgjerim të ulët pas aplikimit.

Çmimi

**690**





## TEKASIL SILIKON UNIVERSAL TRANSPARENT



**Kodi: 159676**

Për mbylljen e fugave, ngjitje të shkëlqyer në shumicën e materialeve silikate (alumin, qeramikë, qelq, sipërfaqe të glazuara, xham të profilizuar (kopelit), klinker, porcelan...) Rezistente ndaj spektrit të gjerë të kimikateve, rrezeve UV dhe kohës.

**Koha e ngjitjes:**

20 min. (23°C/50% lagështia rel.)

**Temp aplikimit:**

prej +5°C deri +40°C

260 ml

Çmimi

**290**

## TEKASIL SILIKON SANITAR



**159622 - I BARDHË**

**159614 - TRANSPARENT**

Për mbylljen e fugave më ngarkesë të vogël tek te cilat ekziston mundësia e paraqitjes së mykut, për mbylljen e materialeve silikate, përintalimin e xhamave në korniza alumini, për instalimin e xhamit dhe të xhamit të profilizuar (kopelit).

**Koha e ngjitjes:**

20 min. (23°C/50% lagështia rel.)

**Temp aplikimit:**

290 L prej +5°C deri +40°C

280 ml

Çmimi

**550**

## TEKASIL SILIKON NEUTRAL TRANSPARENT



**Kodi: 159697**

Për instalimin e xhamit në korniza druri, alumini dhe PVC si dhe për mbylljen e fugave të dilatimit në fasada. Masë mbyllëse neutrale me elasticitet të qëndrueshëm, e cila është rezistente ndaj spektrit të gjerë të kimikateve, ndikimeve atmosferike dhe kohës. Nuk shkakton korrozion. Nuk rrëshqet nga fugat

**Koha e ngjitjes:**

7 min. (23°C/50% lagështia rel.)

**Temp aplikimit:**

prej +5°C deri +40°C

280 ml

Çmimi

**850**

## TEKASIL SILIKON UNIVERSAL ME NGJYRA



**163292- ANTRACIT/QYMYR**

**163293- BAHAMA BEZHE**

**163301- BELI I BARDHE**

**163294- KARAMEL**

**51725- TRANSPARENT**

**163296- MANHATAN /KAF NE PORTOKALL**

Për mbylljen e fugave, lidhjen ndërmjet mureve të dushit dhe qeramikës, ndërmjet lavamanit dhe mobiljeve, lidhjeve ndërmjet e pllakave etj

**Koha e ngjitjes:**

20 min. (23°C/50% lagështia rel.)

**Temp aplikimit:**

prej +5°C deri +40°C

300 ml

Çmimi

**890**

## TEKADOM SILIKON UNIVERSAL PARKET



**159533 - ASH/FRASHER**

**159509 - BEECH / AHU**

**159514 - OAK / LIS**

Për punime finale të shtrimit të parketeve. Mbush dhe mbyll fugat ndërmjet pllakave prej druri, listelave, murit dhe pragjeve. Është rezistent ndaj ndikimeve atmosferike, rrezeve të diellit dhe kohës.

**Koha e ngjitjes:**

15 min. (23°C/50% lag. relative)

**Temp aplikimit:**

prej +5°C deri +40°C

300 ml

Çmimi

**330**

## TEKADOM MBUSHËS UNIVERSAL AKRILIK I BARDHË



**Kodi: 159469**

Për mbylljen e materialeve poroze ndërtimore (mundet edhe të lagështa), të cilat iu nënshtrohen ndikimeve të vogla (kornizat mes dritareve, dyerve). Është rezistente ndaj ndikimeve atmosferike, rrezeve të diellit dhe kohës. Nuk përmban tretës

**Koha e ngjitjes:**

15 min. (23°C/50% lagështia rel.)

**Temp aplikimit:**

prej +5°C deri +40°C

260 ml

Çmimi

**190**

## TEKAFIX SILIKON UNIVESAL PËR PASQYRA



**Kodi: 159550**

Për ngjitjen e pasqyrave në baza të ndryshme. Ngjitje të shkëlqyer në dru, qeramikë, smalt, mur. Nuk rrëshqet nga fugat vertikale dhe nuk shkakton korrozion. Vendoset në vija vertikale në pjesën e pasme të pasqyrës.

**Koha e ngjitjes:**

7 min. (23°C/50% lag. relative)

**Temp aplikimit:**

prej +5°C deri +40°C

300 ml

Çmimi

**720**

## TEKAFIX SILIKON TRANSPARENT AKUARIUMI



**Kodi: 50713**

Për ngjitjen e qelqit gjatë ndërtimit të akuariumeve dhe mbylljen e konstruksioneve më të mëdha prej qelqi. Shfaq rezistencë kimike dhe ndaj rrezeve UV. Akuariumet deri në 150 i mund t'i ndërtojme pa përforcime shtesë.

**Koha e ngjitjes:**

20 min. (23°C/50% lag. relative)

**Temp aplikimit:**

prej +5°C deri +40°C

300 ml

Çmimi

**790**

## SILIKON SALLAM TEKASIL PËR XHAM

NGJYRA 600 ml



160963

Tekasil Neutral Profi është një izolues silikoni me një përbërës, me elasticitet të përhershëm, neutral, i përdorur për instalimin e xhamit në korniza druri, aluminoze PVC dhe për mbylljen e fugave. Ka një ngjitje të mirë në xham, dru, beton, qeramikë, alumin, tulla, metal, porcelan dhe shumicën e plastikës. Është rezistent ndaj rrezeve ultraviolet. Nuk shkakton korrozion.

Çmimi  
**850**

## SILIKON SALLAM TEKADOM ACRYFLEX

NGJYRA 600 ml



51132

Tekadom Acryflex është një izolues plastoelastik jashtëzakonisht fleksibël me një komponent i bazuar në disperzionin e veçantë akrilik. Përdoret në një gamë të gjerë aplikimesh. Rezistent ndaj rrezeve UV. Përdoret për mbushjen e materialeve të ndryshme si beton, dru, suva, pllaka qeramike gipsi, xhami, alumin, metale, PVC, çeliku.

Çmimi  
**420**

## SILIKON SALLAM TEKADOM AKRILIK

NGJYRA 600 ml



152865

Tekadom Akrilik është një izolues për mbylljen e materialeve poroze ndërtimore (mundet edhe të lagështa), të cilat iu nënshtrohen ndikimeve të vogla (kronizat mes dritareve, dyerve). Është rezistente ndaj ndikimeve atmosferike, rrezeve të diellit dhe kohës.

Çmimi  
**350**

## SILIKON NGJITËS FIX-14

300 ml

51888

Për ngjitjen e materialeve të ndryshme poroze të ndërtimit që nuk janë të ekspozuara ndaj ngarkesave të rënda. Për ngjitjen e stiroporit, zbukurimeve dekorative, parvazeve të dritareve, pareteve dekorative... Për ngjitjen e qeramikës (pllaka qeramike, etj.) Pa tretës, nuk shkakton korrozion.



Çmimi  
**250**

## SPRAJ NGJITËS UNIVERSAL FIX-71

250 ml

46932

Për ngjitjen e materialeve të drurit, metalit, qelqit, shkumës PU, letrës, tekstilit, tapës, plastikës, PE, najlont. Për përdorim shtëpiak dhe industrial. Valvul me tre pozicione përgjërësi të ndryshme aplikimi. Pa tretës, nuk shkakton korrozion.



Çmimi  
**390**

## ADEZIV SHIRINGE ME DY PERBERES FIX-61

6 ml

155670

Për ngjitjen dhe riparimin e mermerit, qelqit, qeramikës, porcelanit, lëkurës, metalit dhe plastikës. Forcë ngjitëse e lartë, ngjitje e shpejtë (5 minuta). Rezistent ndaj temperaturave të larta, ujit dhe acideve të holluara. Mund të lyhet dhe zmerilohet



Çmimi  
**280**

## NGJITËS MASTIC UNIVERSAL FIX-41

Për ngjitjen e materialeve të ndryshme të gomës, lëkurës, tapës, drurit, plastikës etj. Përdorim i lehtë dhe i gjithanshëm, nje elastike, forcë lidhëse e lartë. Rezistent ndaj lagështirës holluara. Mund të lyhet dhe zmerilohet



## NGJITËS MASTIC UNIVERSAL FIX-41

KODI 51805  
50 ML

Çmimi  
**280**

## NGJITËS MASTIC UNIVERSAL FIX-41

KODI 51780  
125 ML

Çmimi  
**450**



## NATRIBAN / SKOC PAKETIMI



### Aplikimi:

- Përdoret për qese plastike, kuti të lehta dhe paketim suvenirësh

### Vecorite

- I lehte për tu hapur
- Rezistent ndaj nxehtesise dhe te ftohtit



Kodi	Ngjyra	Dimensionet	Çmimi
602088	Kafe	45 mm x 100 m	<b>149</b>
602089	Transparent	45 mm x 100 m	<b>149</b>

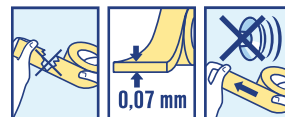

## TENIE LETRE REZISTENTE NDAJ NXEHTESISE



### Aplikimi:

- Ideale për industrinë e arkitekturës detare.
- Per punimet e lysterjes se shtepive

### Vecorite

- Rezistent ndaj nxehtesise
- Rezistente ndaj rrezeve UV
- Ngjitje e larte fillestare



Kodi	Ngjyra	Dimensionet	Çmimi
602091	Bardhe	18 mm x 35 m	<b>89</b>
602093	Bardhe	24 mm x 35 m	<b>95</b>
602095	Bardhe	36 mm x 35 m	<b>129</b>
602097	Bardhe	48 mm x 35 m	<b>190</b>
602090	Portokalli	18 mm x 35 m	<b>99</b>
602092	Portokalli	24 mm x 35 m	<b>129</b>
602094	Portokalli	36 mm x 35 m	<b>199</b>
602096	Portokalli	48 mm x 35 m	<b>250</b>



## TENIE LETRE BLU SPECIALE, REZISTENTE NDAJ NXEHTESISE DHE RREZEVE UV



### Aplikimi:

- Ngjitje e fortë në sipërfaqe të ndryshme si metal, goma, qelqi dhe plastika

### Vecorite

- Ngjyra blu e gjallë lejon shikueshmëri të lartë.
- Rezistent ndaj nxehtesise dhe rrezeve UV



Kodi	Dimensionet	Çmimi
602098	18 mm x 35 m	<b>190</b>
602099	24 mm x 35 m	<b>220</b>
602100	36 mm x 35 m	<b>320</b>
602101	50 mm x 35 m	<b>440</b>

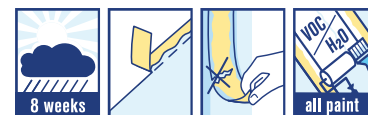



## SINJALIZUES REZISTENT NDAJ ZHVESHJES NGA SIPERFAQJA



### Aplikimi:

- përdoret në zona ndërtimi, zona pune të lyerjes, skena paralajmëruese rreziku dhe çdo zonë potencialisht të rrezikshme.

### Vecorite

- Dukshmëri e lartë, i papërshkueshëm nga uji, me ngjyra të ndezura



Kodi	Ngjyra	Dimensionet	Çmimi
602103	Kuq / Bardhe	45 mm x 30 m	<b>350</b>

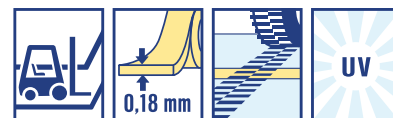

## TENIE ALUMINI REZISTENTE NDAJ NXEHTESISE -30 - 200



### Aplikimi:

- Përdoret për izolim termik dhe riparim.
- Per perdorim te pergjithshem

### Vecorite

- Rezistence e lartë ndaj nxehtesise
- Karakteristika ideale për prodhimet e bardha dhe industrinë e automobilave



Kodi	Dimensionet	Çmimi
602073	48 mm x 25 m	<b>250</b>
602074	48 mm x 50 m	<b>450</b>
602075	48 mm x 100 m	<b>650</b>

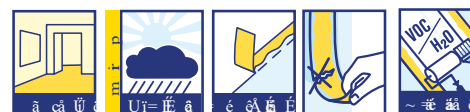

## TENIE ANTI RRESHKITESË TRANSPARENTE / ZEZE



### Aplikimi:

- Perdoret ne shkalle, pishine, jaht dhe anije
- Aplikohet ne siperfaqe mermeri graniti, druri ose guri.

### Vecorite

- Rezistente ndaj rreshqitjeve



Kodi	Dimensionet	Çmimi
602078	25 mm x 15 m	<b>350</b>
602079	25 mm x 15 m	<b>350</b>



## IZOLUES ELEKTRIK I ZI REZISTENT NDAJ FERKIMIT TE LARTE MEKANIK



### Aplikimi:

- Përdoret për izolimin e motorëve elektrikë dhe transformatorëve që kërkojnë rezistencë maksimale ndaj nxehtësisë dhe ferkimit mekanik

### Vecorite

- Përdoret për kontrollin e kablove.
- Mundëson izolimin e zërit.
- Strukturë fleksibël dhe e butë



Kodi	Dimensionet	Çmimi
602086	18 mm x 10 m	<b>39</b>



## TENIE ME PVC GRI E PERFORCUAR ME FIBRA XHAMIT



### Aplikimi:

- Përdoret për fiksimin e veglave dhe pjesëve të rënda
- Përdoret për fiksimin e xhamit

### Vecorite

- Rezistent ndaj nxehtësisë
- Rezistente ndaj rrezeve UV
- Ngjitje e lartë fillestare



Kodi	Dimensionet	Çmimi
602087	48 mm x 10 m	<b>120</b>



## BIADEZIV TRANSPARENT

**ERE**



### Aplikimi:

- Performancë max ne sipërfaqe metalike, plastike dhe celofani.

### Vecorite

- Nuk lë gjurmë, e lehtë për tu hequr/aplikuar
- Shirit standard i dyanshëm.
- Ngjitje e lartë fillestare
- Rezistent ndaj lagështirës.



Kodi	Dimensionet	Çmimi
602104	18 mm x 20 m	<b>90</b>
602105	24 mm x 20 m	<b>115</b>
602106	36 mm x 20 m	<b>165</b>
602107	48 mm x 20 m	<b>220</b>

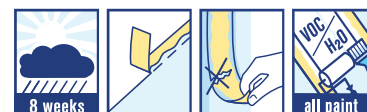

**SET ME 3 TENIE LETRE  
TE BARDHA**

Kodi	Permasa	Çmimi
96003310	30 mm x 50 m	<b>350</b>
96004910	48 mm x 50 m	<b>550</b>

**SET ME 2 TENIE LETRE  
+ QESE MBULIMI**

Kodi	Permasa	Çmimi
96002199	30 mm x 50 m Qese mbulimi 4x5 m	<b>450</b>

**FURCE BOJE E SHESHTE  
ME BISHT DRURI UNI-STAR**

Kodi	Permasa	Çmimi
828025A	25 mm (A)	<b>220</b>
828225A	25 mm (B)	<b>99</b>

**FURCE BOJE ME BISHT  
DRURI WOODSTAR JESHILE  
QIME NATYRALE SINTETIKE**

Kodi	Permasa	Çmimi
815430A	30 mm	<b>150</b>
815440A	40 mm	<b>199</b>

**TENIE LETRE  
PORTOKALLI UHV**

Kodi	Permasa	Çmimi
96245099	48 mm x 50 m	<b>330</b>

**STRECH PER PAKETIM**

Kodi	Permasa	Çmimi
FST-23	3 kg / 23 micron	<b>990</b>

**FURCE BOJE PER KENDE  
&PRERJE UNI-STAR**

Kodi	Permasa	Çmimi
818725A	25 mm	<b>190</b>

**FURCE BOJE ME BISHT E  
GOMUAR WOODSTAR JESHILE  
QIME NATYRALE SINTETIKE**

Kodi	Permasa	Çmimi
831610A	100 mm	<b>290</b>

**TENIE LETRE E BARDHE**

Kodi	Permasa	Çmimi
96574899	48 mm x 50 m	<b>220</b>

**FURCE BOJE ME BISHT  
DRURI UNI-STAR**

Kodi	Permasa	Çmimi
811821A	20 mm	<b>119</b>
811871A	70 mm	<b>289</b>

**FURCE BOJE PER KENDE  
&PRERJE**

Kodi	Permasa	Çmimi
816536A	35 mm	<b>290</b>

**FURCE BOJE WOODSTAR  
BISHT PLASTIK JESHILE  
QIME NATYRALE SINTETIKE**

Kodi	Permasa	Çmimi
837010A	100 mm	<b>290</b>



**FURCE BOJE ME BISHT  
E GOMUAR ME KEND  
QIME NATYRALE SINTETIKE**



Kodi	Permasa	Çmimi
831412A	120 mm	<b>290</b>

**RRUL BOJE REZERVE  
MICROFIBER**



Kodi	Permasa	Çmimi
865230A	100 mm	<b>99</b>

**BISHT RRULI BOJE  
100-160 MM  
ME BISHT TE GOMUAR**



Kodi	Permasa	Çmimi
860439A	390 mm	<b>220</b>
860429A	290 mm	<b>150</b>

**ZMERILUESE SANDMAST  
DORE ME BAZAMENT  
+ MBAJTESE PLASTIKE**



Kodi	Permasa	Çmimi
933804A	210 x 105 mm	<b>250</b>

**RRUL BOJE REZERVE  
POLIAMIDE WALLSTAR  
I BARDHE ME VIJA TE KUQE**



Kodi	Permasa	Çmimi
847225A	12 x 250 mm	<b>220</b>

**RRUL BOJE POLIMADINE  
MIKROFIBER WALLSTAR**



Kodi	Permasa	Çmimi
864335A	260 mm / 15 cm	<b>290</b>

**BISHT RRULI BOJE  
STANDART  
COLOR-EXPERT BISHT 290MM**



Kodi	Permasa	Çmimi
86002910	100 mm	<b>99</b>
84001810	180 x 8 mm	<b>220</b>

**THIKE TAPICERIE MULTI-  
FUNKSIONALE METALIKE**



Kodi	Permasa	Çmimi
955002A	61 x 19 mm	<b>99</b>

**SET ME 2 RRULA BOJE  
SFUNGJERI**



Kodi	Permasa	Çmimi
867211A	100 mm	<b>200</b>
865210A	100 mm	<b>200</b>

**SET ME 4 SHPATULLA  
INOXI**



Kodi	Materiali	Çmimi
910004A	Inoxi	<b>250</b>

**BISHT RRULI BOJE  
ALUMINI**

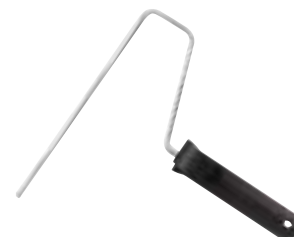

Kodi	Permasa	Çmimi
840918A	180 x 8 mm	<b>190</b>

**THIKE TAPICERIE ME SHINE  
DHE DOREZE PLASTIKE**



Kodi	Permasa	Çmimi
956110A	9 x 80 mm	<b>99</b>

**TENIE RROBE NGJITSE  
PER RIPARIME**

Kodi	Permasa	Çmimi
962753A	50 mm x 10 m	<b>450</b>

**TENIE NGJITSE PVC  
E BARDHE**

Kodi	Permasa	Çmimi
961430A	30 mm x 33 m	<b>220</b>

**SET ME 2 SFUNGJERA  
ZMERILIMI**

Kodi	Permasa	Çmimi
930710A	150 x 210 mm	<b>330</b>

**SILIKON UNIVERSAL  
280 ML**

Kodi	Te dhena	Çmimi
P30T	Transparent	<b>180</b>
P30W	I bardhe	<b>180</b>

**SILIKON SANITAR  
280 ML**

Kodi	Te dhena	Çmimi
P40T	Transparent	<b>220</b>
P40W	I bardhe	<b>220</b>
P40Z	I zi	<b>220</b>
P40G	Gri	<b>220</b>

**SHKUME PER MBUSHJE  
DORE**

Kodi	Te dhena	Çmimi
P70D	750 ml	<b>350</b>

**SHKUME PER MBUSHJE  
PISTOLETE**

Kodi	Te dhena	Çmimi
P70P	750 ml	<b>350</b>

**SHKUME LOW  
EXPANSION DORE**

Kodi	Te dhena	Çmimi
P90D	700 gr	<b>390</b>

**SHKUME LOW  
EXPANSION PISTOLETE**

Kodi	Te dhena	Çmimi
P90P	700 gr	<b>390</b>

**PASTE PASTRIMI  
DUARSH MARGHERITE**

Kodi	Te dhena	Çmimi
MA100	1L	<b>450</b>

**PASTE PASTRIMI  
DUARSH MARGHERITE**

Kodi	Te dhena	Çmimi
MA103	4L	<b>1.190</b>
MA104	5L	<b>1.390</b>

**KREM PASTRIMI  
DUARSH MARGHERITE**

Kodi	Te dhena	Çmimi
MA107	1L, e bardhe	<b>550</b>
MA106	4L, e bardhe	<b>1.650</b>

## TENIE RROBE NGJITSE PER RIPARIME

Kodi	↔	Ngjyra	Kuti	Çmimi
CS5010	48mm x 10m	Argjënd në ekspozitor	12	499
CB5010	48mm x 10m	E Zezë në ekspozitor	12	499

- Cloth Tape mjaft e fortë, me cilësi të lartë, me ngjitës me forcë të lartë
- Pritet me dorë
- I papërshkueshëm nga uji dhe rezistent ndaj të gjitha kushteve atmosferike.
- Reziston deri në 60°C (për periudha të shkurtra mbi 1 ore, deri në 80°C)
- Rezistenca në tërheqje: 183N/25mm
- Forca ngjitëse: 13N/25mm
- Trashësia: 0.30µm



## TENIE RROBE NGJITSE PER RIPARIME

Kodi	↔	Ngjyra	Kuti	Çmimi
DP0026	48mm x 25m	Gri në ekspozitor	12	990
DP0025	48mm x 25m	E Zezë në ekspozitor	12	990
CR5025	48mm x 25m	E Kuqe	30	990
CY5025	48mm x 25m	E verdhë	30	990



## SHIRIT NGJITES DUCT TAPE 1900

Kodi	↔	Ngjyra	Kuti	Çmimi
PE5025	48mm x 25m	Gri	30	490

- Tenije për përdorim të përgjithshëm të tipit duct tape
- I përshtatshëm për paketim, riparime të përkohshme etj
- Pritet me dorë
- Mund të përballojë deri në 75°C
- Rezistenca në tërheqje 75N/25mm
- Forca ngjitëse: 20N/25mm
- Trashësia: 0.17µm



## IZOLANT ELEKTRIK 52100 PVC

Kodi	↔	Ngjyra	Kuti	Çmimi
IB1920	19mm x 20m	E Zezë	250	199
IW1920	19mm x 20m	E Bardhë	250	199
IR1920	19mm x 20m	E Kuqe	250	199
IG1920	19mm x 20m	Gri	250	199

- Izolant PVC elektrik me certifikate VDE
- I përshtatshëm për izolimin për forcimin, mbrojtjen dhe riparimin e kablove elektrike
- Ngadalëson transmetimin e flakës.
- I lehtë për t'u hequr
- Reziston deri në 90°C
- Trashësia: 0.16µm
- Forca ngjitëse: 5N/25mm
- Rezistent deri në: 6000V



## BIADZIV TRANSPARENT PER MONTIM



Kodi	↔	Ngjyra	Kuti	Çmimi
UM1910	19 x 10m	Transparent	20	690

- Biadziv transparent me një ngjitës të fuqishëm.
- Rezistent ndaj lagështirës, UV dhe temperaturave të larta.
- I përshtatshëm për tabela.
- I përshtatshëm për ABS, poliester, EPDM
- Trashësia 0.20mm
- Qëndron deri në 100°C
- Rezistenca në prerje: 5.4kg/cm2
- Forca ngjitëse: 18N/25mm





## IZOLUES TRANSPARENT



Kodi	↔	Ngjyra	Kuti	Çmimi
SZ2503	25mm x 3m	Transparente	6	1.390

- Krijon riparim të përhershëm të papërshkueshëm nga uji.
- Izolues elektrik
- I përshtatshëm për të gjitha sipërfaqet
- Përballon presionin deri në 8 Bar
- Mund të përballojë deri në 200°C C (deri në 260° ngjitje për intervale të shkurtra)
- Rezistenca në tërheqje 4.82mPa
- Trashësia: 0.50µm
- Rezisten deri në: 8000V



## TENIE ABRASIVE ANTIRRESHQITËSE



Kodi	↔	Ngjyra	Kuti	Çmimi
SB2505	25mm x 5m	E Zezë	36	990

- Mbrojtje kundër rrëshqitjes për sipërfaqe të lëmuara
- Ngjitje shumë të forte në sipërfaqe.
- I përshtatshëm për përdorim profesional ose shtëpiak
- Rezistent ndaj kimikateve dhe ujit
- Për hapësira të brendshme dhe të jashtme
- Qëndron deri në 50°C
- Rezistenca në tërheqje 59N/25mm
- Trashësia: 0.80µm
- Forca ngjitëse: 16N/25mm



## ADEZIV TRANSPARENT KUNDER RRESHQITJES



Kodi	↔	Ngjyra	Kuti	Çmimi
AG2024	20x 240mm	Transparent	36	1.150

- Shirit transparent kundër rrëshqitjes 100%
- Përdoret për pishina, duše, varka dhe vaska
- Rezistencë ndaj ujit të detit dhe klorit
- Rezistencë ndaj rrezatimit UV
- Ideale për përdorim të brendshëm dhe të jashtëm
- Qëndron deri në 50°C
- Rezistenca në tërheqje 59N/25mm
- Trashësia: 0.90mm
- Fortësia ngjitëse: 15N/25m



## TENIE ALUMINI



Kodi	↔	Ngjyra	Kuti	Çmimi
AL5010	50mm x 10m	Gri	54	320

- I përshtatshëm për riparimin dhe ngjitjen e metaleve
- I reziston edhe temperaturave të ulëta
- Qëndrueshmëri e shkëlqyer
- Qëndron deri në 120°C
- Rezistenca në tërheqje: 55N/25mm
- Forca ngjitëse: 20N/50mm
- Trashësia: 0.08µm



## BIADEZIV PE PËR MONTIMIN E PASQYRAVE



Kodi	↔	Ngjyra	Kuti	Çmimi
DS1205S	12mm x 5m	E Bardhë	40	460
DS1905	19mm x 5m	E Bardhë	24	690

- Biadeziv i fuqishëm me ngjitës akrilik
- Ideale për montimin e pasqyrave, kornizave etj.
- Për aplikime të brendshme dhe të jashtme.
- Qëndron deri në 120°C
- Rezistenca në prerje: 6.6kg/cm2
- Trashësia: 1.10µm
- Forca ngjitëse: 25N/25mm



## BIADEZIV PËR AUTOVETURA



Kodi	↔	Ngjyra	Kuti	Çmimi
ZC04	12mm x 10m	E Zezë	10	820

- Biadeziv me ngjitje të shkëlqyer.
- Ngjitje shumë e mirë në sipërfaqet e lyera, metale, dru, plastikë.
- Rezistencë e madhe ndaj motit, e përshtatshme për përdorim në vende që janë jashtë për të madhe intervale.
- Qëndron deri në 100°C
- Rezistenca në prerje: 6.6kg/cm<sup>2</sup>
- Trashësia: 1.05µm
- Forca ngjitëse: 29N/25mm



## MAX POWER BIADEZIV TRANSPARENT

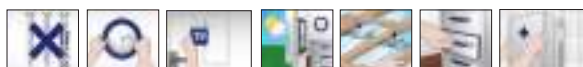

Kodi	↔	Ngjyra	Kuti	Çmimi
APHT1902	19mm x 2m	Transparente	12	990

- Biadeziv transparent me ngjitës akrilik shumë të fortë.
- Ngjitje shumë e mirë me metalin, xhamin dhe shumicën e llojeve të plastikës.
- Fortësia 1.5kg/cm<sup>2</sup>
- Rezistencë e madhe ndaj lagështirës.
- Zëvendëson gozhdat, vidat dhe ngjitësit e lëngshëm.
- Qëndron deri në 120°C
- Rezistenca në prerje: 5.9kg/cm<sup>2</sup>
- Trashësia: 1.00µm
- Forca ngjitëse: 29N/25mm



## SHIRIT VETENGJITES ZIP FIX



Kodi	↔	Ngjyra	Kuti	Çmimi
ZF2001	2 x 20mm x 1m	E errët	10	890

- Shirit vetëngjites shumë i fortë
- I përshtatshëm për një sërë aplikacionesh fiksimi - mbajtëse, p.sh. kablllo makinash, sisteme audio, vegla, etj
- Ngjitje e mirë me metal, xhami, dru. Qeramika dhe shumica e plastikës.
- I përshtatshëm edhe për përdorim të jashtëm



## SHIRIT FIKSUES I DYFISHTË

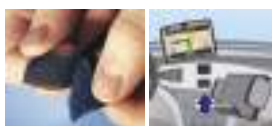

**FIKSIM SHUMË I FORTË NE 25x25 mm MBAN PESHE 7 Kg**



Kodi	↔	Ngjyra	Kuti	Çmimi
DG1000	25mm x 25mm	E Zezë	20	650

- Fiksimit i fuqishëm
- I përshtatshëm për ngarkesa të lehta dhe të rënda, p.sh. dyshekë për dysheme, vegla veturash, audio etj
- Përballon deri në 5 herë më shumë ngarkesë se shiritat tradicionale të tipit velcro.



## SHIRIT NGJITES I DYANSHEM PER TAPETE



Kodi	↔	Ngjyra	Kuti	Çmimi
CE5025	48mm x 25m	E Bardhë	24	650

- Aplikohet për qëllime të përgjithshme
- I përshtatshëm për fiksimin e tapeteve dhe dyshemeve të tjera.
- Qëndron deri në 60°C
- Rezistenca në tërheqje: 175N/25mm
- Forca ngjitëse: 14N/25mm



## AROMATIZUES MAKINE

### Pemë aromatizuese Black Ice

Pemë aromatizuese e Little Trees me aromë Black Ice është një aromë për meshkuj përbëhet nga dru sandali, bergarnot dhe limon dhe jep një notë mister.



### Pemë aromatizuese Vanilje

Pemë aromatizuese e Little Trees me aromë Vanilje është një përzierje e vaniljes, qumështit të kokosi dhe kallam sheqeri.

Kodi	Kufi	Lekë
780100141	24	250

Kodi	Kufi	Lekë
789200141	24	250



### Pemë aromatizuese Bubble Gum

Pemë aromatizuese e Little Trees me aromë çamçakëzi është një përzierje e ëmbël me shije frutash.

Kodi	Kufi	Lekë
789300141	24	250

### Pemë aromatizuese Arrë Kokosi

Pemë aromatizuese e Little Trees me aromë Arrë Kokosi ofron një përzierje ëndërrimtare arrë kokosi dhe vanilje me erëza.

Kodi	Kufi	Lekë
780400141	24	250

### Pemë aromatizuese New car

Pemë aromatizuese e Little Trees me aromë New car ofron erën e pasur e në makine krejt të re.

Kodi	Kufi	Lekë
780500141	24	250

### Pemë aromatizuese Luleshtrydhe

Pemë aromatizuese e Little Trees me aromë Luleshtrydhe është aroma e ëmbël e luleshtrydheve të sapo vjelura.

Kodi	Kufi	Lekë
781000141	24	250



### Pemë aromatizuese Pishë

Pemë aromatizuese e Little Trees me aromë Pishë, lëshon erën e halave të pishës, nenexhik i freskët dhe livando mali e kombinuar për të krijuar një atmosferë të freskët.

Kodi	Kufi	Lekë
788000141	24	250



Ekskluzive në

**BAUMARKET**



**90** Anniversary  
1934-2024



**Ekskluzive në**

**BAUMARKET**

## **CABLE - FREE INSTALIM PA TEL**



**Korrëset autonome robotike STIGA lundrojnë pa pasur nevojë për tel. Instalimi është plotësisht virtual dhe kryhet nëpërmjet aplikacionit STIGA.GO**

### **Si funksionon roboti me sinjalin GPS?**

Korrësja e re robotike autonome STIGA punon duke mbledhur informacion nga sinjalet e satelitëve, si nga GPS ashtu edhe nga të gjitha sistemet e tjera GN GNSS, për të njohur pozicionet e tyre dhe për të lundruar nëpër kopsht.



## Perimetri plotësisht i adaptueshëm

Korrësja e re robotike autonome STIGA është pa kablo, që do të thotë se instalimi si dhe përcaktimi i perimetrit mund të menaxhohen plotësisht nëpërmjet aplikacionit. Kjo do të thotë, sa herë që diçka ndryshon në kopsht, perimetri mund të modifikohet lehtësisht nga përdoruesi në pak minuta.



## Pse RTK (Kinematik në kohë reale)?

Teknologjia RTK e bën pozicionin e robotit tonë jashtëzakonisht të saktë, falë trekëndëshimit të vazhdueshëm të të dhënave midis vetë robotit, satelitëve në qiell dhe stacionit të referencës të instaluar në kopsht.

## Komunikimi i vazhdueshëm përmes STIGA Cloud

Korrësja autonome robotike STIGA përdor rrjetin 4G për të bërë që dialogu midis robotit dhe stacionit të referencës të ndodhë vazhdimisht. Një mjedis i sigurt i të dhënave, ku ruhen të gjitha të dhënat dhe cilësimet rreth robotit.





**AUTOMOWER A1500**  
2R7102028/ST1

- Robot per korren e barit me instalim pa tela
- Robot per kopshte deri ne 1500 m<sup>2</sup>
- Performanca maksimale e pjerrësisë brenda instalimit: 45 %
- Shpejtesisa e prerjes: 22 metra per minute
- Kontroll i plotë nëpërmjet aplikacionit STIGA.GO. Integruar me Alexa
- I pershtatshem per cdo kohe dhe kushte atmosferike
- Pasjitur me te gjitha aksesoret e nevojshme per instalim si: Stacioni i lidhjes me stacionin referues si dhe karikuesi.

**ÇMIMI**  
**290.000 Lek**

**Kasë që amortizon goditjet**

Kasa e jashtme është projektuar për të 'lundruar' mbi lidhjet e saj me shasinë e poshtme. Kjo do të thotë që çdo goditje thithet nga guaska, duke parandaluar dëmtimin si të robotit ashtu edhe të çdo objekti me të cilin ai bie në kontakt.

**Qasje e lehtë për mirëmbajtje**

Kasa e jashtme mund të hiqet lehtësisht, pa pasur nevojë për mjete për të lejuar pastrimin dhe servisimin. Kositësit robot STIGA kanë një vlerësim IPX5 të papërshkueshëm nga uji duke e bërë të sigurt pastrimin me një zorrë kopshti.

**Rrota që nuk lënë gjurmë**

Gjerësia e rrotave e shpërndan peshën në mënyrë të barabartë në mënyrë që të mos lërë linja të pahijshme nëpër lëndinë

**Madhësi kompakte**

Robotët janë bërë sa më të ngushtë të jetë e mundur duke optimizuar gjerësinë e prerjes për të siguruar manovrim më të madh dhe aftësi për t'u përshtatur nëpër hapësira të ngushta.

**Pajisja prerëse me performancë të lartë**

Të pajisura me 4 deri në 6 thika rrotulluese prej çeliku të karbonit, që rrotullohen deri në 2850 rpm, korrëset e reja robotika autonome STIGA sigurojnë performancën më të lartë të prerjes dhe ushqejnë një lëndinë të shëndetshme e të gjelbër.

**Karikimi i automatizuar**

Kur niveli i baterisë së robotit është e ulët, ajo automatikisht do të kthehet në stacionin e karikimit dhe do të lidhet përmes portës së karikimit. Sapo bateria të rikarikohet, roboti do të vazhdojë me punën.



**KORRESE BARI  
ELEKTRIKE ALPINA**

- | ALPINA BL320E
- | Fuqia 1000 W
- | Gjeresi prerje : 32 cm
- | Koshi 25 lt



Kodi : 293320064/A14

**ÇMIMI  
9.900 Lek**



**KORRESE BARI  
ELEKTRIKE ALPINA**

- | ALPINA BL380E
- | Fuqia 1400 W
- | Gjeresi prerje : 38 cm
- | Koshi 40 lt



Kodi : 293380064/A14

**ÇMIMI  
13.500 Lek**



**ELEKTROKOSE  
ELEKTRIKE**

- | GT 106C
- | Fuqia 600 W
- | Fije Tap & Go 1.5 mm
- | Gjeresia e prerjes 30 cm

Kodi : 252060002/ST1

**ÇMIMI  
11.000 Lek**



**ELEKTROSHARRE**

- | CS 118
- | Fuqia 1800 W
- | Shpata 35 cm
- | Shpejtesia e zinxhirit 10 m/s

Kodi : 292614008/ST2

**ÇMIMI  
17.500 Lek**



**FRYRESE GJTHESH  
ELEKTIKE**

- | BL130C V
- | Fuqia 2600 W
- | Volumi ajrit 92 m<sup>3</sup>/min
- | Max fryrjes 7 m<sup>3</sup>/min

Kodi : 255260002/ST1

**ÇMIMI  
14.900 Lek**



**KRASITESH LIGUSTRASH  
ELEKTRIKE**

- | HT 105c
- | Fuqia 500 W
- | Gjatesia e lames 45 cm
- | Dimensioni max i prerjes 16 mm

Kodi : 256050002/ST1

**ÇMIMI  
13.900 Lek**



# STIGA

## MOTOSHARRE ME BATERI

- | PR 700e
- | Tensioni 48 V
- | Shpata 30 cm
- | Zinxhiri 3/8".050"
- | Motor pa karboncina
- | Vetem trup

Kodi : 278420008/ST3

ÇMIMI  
**33.900 Lek**



## MOTOSHARRE ME BATERI

- | CS 700e
- | Tensioni 48 V
- | Shpata 35 cm
- | Zinxhiri 3/8".050"
- | Motor pa karboncina
- | Vetem trup

Kodi : 277430008/ST1

ÇMIMI  
**38.900 Lek**



## KRASITESH LIGUSTRASH ME BATERI

- | HT 500e kit
- | Me 1 bateri 48 V / 2.0 Ah
- | Gjatesia e lames 58 cm
- | Dimensiioni max i prerjes 18 mm

Kodi : 278302108/ST3

ÇMIMI  
**37.900 Lek**



## FRYRESE GJTHESH ME BATERI

- | BL 500e kit
- | Tensioni 48 V
- | Shpejtesia fryrjes 55 m/s
- | Max fryrjes 11,4 m³/min

Kodi : 278502108/ST3

ÇMIMI  
**37.900 Lek**



## ePower Sistemi 48V

Plotesisht i kembyeshem  
Nje bateri per cdo makineri

Të gjitha bateritë STIGA ePower janë projektuar, zhvilluar dhe prodhuar nga STIGA. Testuar në një përdorim "në jetën reale", shumë përtej standardit të industrisë, deri në 750 cikle  
Bateritë 48V ePower janë të disponueshme në një gamë të gjerë kapacitetesh, nga 2 deri në 7,5 Ah, duke fuqizuar produkte të ndryshme për shumë aktivitete të kujdesit të kopshtit.

## KORRESE BARI ME BATERI 20 V

- | COLLECTOR 136e kit
- | Me 2 bateri 20 V / 2.0 Ah
- | Thika 34 cm
- | Rregullim lartesisë së prerjes  
Me 6 nivele 25-75 mm
- | Koshi 35 lt

Kodi : 291342068/ST2

ÇMIMI  
**29.900 Lek**



## KORRESE BARI ME BATERI 48 V

- | COMBI 336e
- | Me 1 bateri 48 V / 2.0 Ah
- | Gjerësi prerje 34 cm
- | Lartësi prerje 25-75 cm
- | Koshi 35 lt
- | Motor pa karboncina

Kodi : 294346068/ST2

ÇMIMI  
**39.900 Lek**



## KORRESE BARI ME BATERI 48 V

- | COMBI 344e
- | Me 1 bateri 48 V / 5.0 Ah
- | Gjerësi prerje 42 cm
- | Lartësi prerje 25-75 cm
- | Koshi 50 lt
- | Motor pa karboncina

Kodi : 294426068/ST2

ÇMIMI  
**49.900 Lek**





## MOTOKOSE ME BATERI

- | GT 500e kit
- | Me 1 bateri 48 V / 2.0 Ah
- | Prerja me fije 1.6 mm
- | Prerja me disk 30 cm

Kodi : 278102108/ST3

ÇMIMI  
**33.900 Lek**



## MOTOKOSE ME BATERI

- | SBC 700 D AE
- | Tensioni 48 V
- | Motori pa karboncina
- | Prerja me fije 2.0 mm
- | Prerja me disk 380 mm
- | Vetem trup

Kodi : 277210008/ST1

ÇMIMI  
**29.900 Lek**



## KRASITSE ME BATERI

- | Tensioni 48 V
- | Shpata 25 cm
- | Zinxhiri 3/8" .050"
- | Pesha 5.6 kg
- | Vetem trup

Kodi : 277710048/ST2

ÇMIMI  
**29.900 Lek**



## MOTOKOSE MULTIFUNKSIONALE ME BATERI

- | MT 500e kit
- | Me 1 bateri 48 V / 2.0 Ah
- | Gjeresia lames 46 cm
- | Gjatesia e shpates 25 cm

Kodi : 278722108/ST3

ÇMIMI  
**49.900 Lek**



EC415S karikues

2.0 Ah

E420 bateri

4.0 Ah

E440 bateri

ÇMIMI  
**7.900 Lek**

ÇMIMI  
**15.900 Lek**

ÇMIMI  
**22.900 Lek**

## KORRESE BARI ME BATERI 48 V

- | COLLECTOR 548 AE
- | Me 1 bateri 48 V / 4.0 Ah
- | Gjeresi prerje 46 cm
- | Lartesi prerje 22-80 cm
- | Koshi 60 lt
- | Motor pa karboncina

Kodi : 2L0485808/ST1

ÇMIMI  
**59.900 Lek**



## KORRESE BARI ME BATERI 48 V

- | Collector 548e S Kit
- | Me 2 bateri 48 V / 5.0 Ah
- | Gjeresi prerje 51 cm
- | Lartesi prerje 22-80 cm
- | Koshi 60 lt

Kodi : 2L0486008/ST1

ÇMIMI  
**79.900 Lek**



## TRAKTOR

- | STIGA ESTATE 384M
- | Motori 352 cm<sup>3</sup>
- | Fuqia 5.8 kW
- | Thika 84 cm
- | Koshi 240 lt
- Kodi : 2T2000481/ST3

**STIGA**

**ÇMIMI**  
**299.000 Lek**



## KORRESE BARI ME BENZINE

- | STIGA COLLECTOR 43
- | Motori 1.9 kW
- | Gjeresi prerje : 41 cm
- | Koshi 60 lt
- Kodi : 2L0431048/ST1

**STIGA**

**ÇMIMI**  
**35.900 Lek**



## KORRESE BARI ME BENZINE

- | STIGA COLLECTOR 48S
- | Fuqia 1.9 kW
- | Gjeresi prerje : 46 cm
- | Koshi 60 lt
- Kodi : 2L0482048/ST1

**STIGA** 

**ÇMIMI**  
**39.900 Lek**



## KORRESE BARI ME BENZINE

- | STIGA COMBI 55 SQ
- | Fuqia 2.60 W
- | Gjeresi prerje : 53 cm
- | Koshi 70 lt
- Kodi : 2L0536148/ST1

**STIGA** 

**ÇMIMI**  
**55.000 Lek**



## KORRESE BARI ME BENZINE ALPINA

- | ALPINA AL4 51 SHQ
- | Motori Honda 145cc / Fuqia 3.2 kW
- | Gjeresi prerje : 51 cm
- | Koshi 60 lt
- Kodi : 2L0536834/A21

**HONDA**   
**ENGINES**

**ÇMIMI**  
**59.900 Lek**



**MOTOKOSE  
ME BENZINE**

- | STIGA BC 535 B
  - | Fuqia 0.9 kW
  - | Motori 32.6 cm<sup>3</sup>
  - | Me disk dhe fije
- Kodi : 287221002/ST1

**STIGA**

**ÇMIMI  
25.900 Lek**

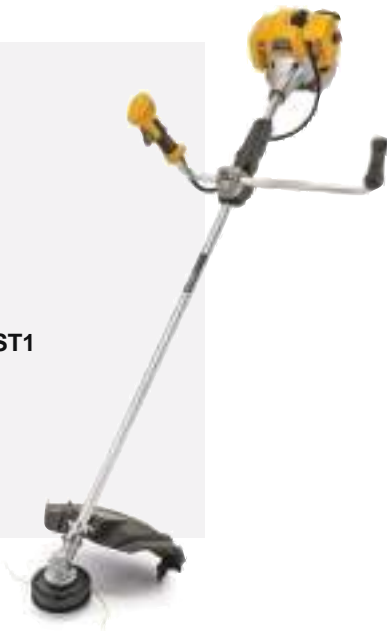

**MOTOKOSE  
ME BENZINE**

- | STIGA BC 545 B
  - | Fuqia 1.25 kW
  - | Motori 42.7 cm<sup>3</sup>
  - | Me disk dhe fije
- Kodi : 287321002/ST1

**STIGA**

**ÇMIMI  
29.900 Lek**

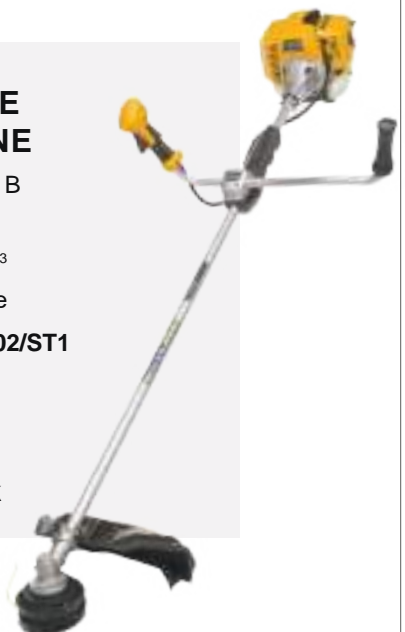

**MOTOKOSE  
ME BENZINE**

- | STIGA BC 555 B
  - | Fuqia 1.55 kW
  - | Motori 51.7 cm<sup>3</sup>
  - | Me disk dhe fije
- Kodi : 287421002/ST1

**STIGA**

**ÇMIMI  
33.900 Lek**



**STIGA**  
**KRASITESH LIGUSTRASH  
ME BENZINE**

- | HT 525
  - | Fuqia 0.65 kW
  - | Gjatesia e lames 60 cm
  - | Doreze e rrotullueshme 180° ne 3 pozicione
- Kodi : 252421008/ST2

**ÇMIMI  
32.500 Lek**



**STIGA**  
**MOTOSHARRE KRASITJE  
ME BENZINE**

- | STIGA PR 730
  - | Shpata 25 cm
  - | Motori 25.6 cm<sup>3</sup>
- Kodi : 240271002/ST2

**ÇMIMI  
29.900 Lek**



**STIGA**  
**MOTOSHARRE  
ME BENZINE**

- | STIGA CS 540
  - | Shpata 35 cm
  - | Motori 38.5 cm<sup>3</sup>
- Kodi : 240381402/ST1

**ÇMIMI  
25.900 Lek**





# FORCE PRO

Ekskluzive në **BAUMARKET**

## Cilësi e shkëlqyer

Makinerite FORCE PRO ju ofrojnë performancë të lartë, besueshmëri dhe cmimet më të mira. Kjo vërtetohet jo vetëm nga shumë klientë të kënaqur, por edhe nga teste të shumta.

### MOTOKOSE ME BENZINE

- ✓ Fuqia 25.4 cc / 0.75 kW
- ✓ Me fije dhe disk

Kodi CGTC26



### MOTOKOSE ME BENZINE

- ✓ Fuqia 32.6 cc / 0.9 kW
- ✓ Me fije dhe disk

Kodi CGTC33



### MOTOKOSE ME BENZINE

- ✓ Fuqia 42.7 cc / 1.25 kW
- ✓ Me fije dhe disk

Kodi CGTC43



### MOTOKOSE ME BENZINE

- ✓ Fuqia 52 cc / 1.4 kW
- ✓ Me fije dhe disk

Kodi CGTC52



### MOTOKOSE ME BENZINE

- ✓ Fuqia 63.3 cc / 2.2 kW
- ✓ Me fije dhe disk

Kodi CG640



### MOTOKOSE ME BENZINE

- ✓ Motor me 4-kohe 33.5 cc / 0.95 kW
- ✓ Me fije dhe disk

Kodi CGET33





**MOTOKOSE ME BENZINE MULTIFUNKSIONALE**

- ✓ Fuqja 25.4 cc / 0.75 kW
- ✓ Me fije dhe disk

**Kodi GJB570**

Çmimi  
**25.500**



**MOTOKOSE ME BENZINE MULTIFUNKSIONALE**

- ✓ Fuqja 25.4 cc / 0.75 kW
- ✓ Me fije dhe disk

**Kodi MT260**

Çmimi  
**20.900**



**KRASITESH LIGUSTRASH ME BENZINE**

- ✓ Fuqja 25.4 cc / 0.75 kW
- ✓ Lama 60 cm

**Kodi SLP600**

Çmimi  
**17.500**



**FRYRESE GJETHESH ME BENZINE**

- ✓ Fuqja 42.7 cc / 1.25 kW
- ✓ Max fryrjes 70 m/s

**Kodi EB430**

Çmimi  
**17.900**



**TURRJELE TOKE**

- ✓ Fuqja 51.7 cc, 1.4 kW
- ✓ Kapja e turrjeles 200 mm

**Kodi DZ52S**

Çmimi  
**18.900**



**MOTOPOMPE ME BENZINE 1" / 1.5"**

- ✓ Motor me 4 kohe 35 cc / 1.1 kW
- ✓ Hedhja 30 m / Prurja 135 l/min

Kodi	Dalja	Çmimi
WP10I	1"	<b>15.900</b>
WP15I	1.5"	<b>17.500</b>





**1** Peshë e lehtë dhe doreza e fortë dhe e vogël e bëjnë më të lehtë transportin



**2** Zgjedhja e presionit optimal dhe funksioni i rregullimi i presionit të ujit



**3** Transport praktik Sistemi 'Plug'n'Clean' për të ndryshuar lehtë detergjentët



**4** Steka 'Vario Power' Sistemi 'Plug'n'Clean' për të ndryshuar lehtë detergjentët 'Lidhja e shpejtë' mundëson lidhje dhe shkëputje të lehtë të makinerisë me zorren



**5** Me funksion ndryshimi presioni pa ndërprerje të punës Sistemi 'Plug'n'Clean' për të ndryshuar lehtë detergjentët Me rregullim presioni me buton dhe ekran LED



**6** Zgjedhja e presionit optimal "Multi Jet" rrotullues 3 në 1 tub reaktiv Sistemi 'Plug'n'Clean' për të ndryshuar lehtë detergjentët. Doreze teleskopike alumini me çilesi të lartë



**7** Teknologjia "Push & Clean" për pastrimin e filtrit gjatë funksionimit **9.** Furça larëse 'WB 60' 24.8 cm, Ideale për lavazhet me presion të lartë KÄRCHER 'K2' - 'K7' **Kodi: 2.643-233.0**



**ÇMIMI 6.900 Lek**



**8** **10.** Solucion larje 'RM 565' 5 l, mban çdo sipërfaqe të lakuar dhe plastike, heq njollat e baltës ose pluhurit nga makina, nuk është i dëmshëm për mjedisin **Kodi 6.295-360.0**



**ÇMIMI 3.500 Lek**



**11.** Solucion 'RM 623' 5 l për pastrime të përgjithshme në sipërfaqe guri pllaka etj, Largon njollat e vaji, yndyrat, blazën, pluhurin ose myshkun nga sipërfaqet prej guri **Kodi 6.295-359.0**

**ÇMIMI 3.900 Lek**

### INFO

2 3 4  
5 6



Këshilltari i përdorimit të aplikacionit ofron kontroll edhe më të mirë mbi fusha dhe lëndë të ndryshme për pastrimin.

Me ndihmën e tij do të zgjidhni lehtësisht presion optimal për pastrimin e zgjedhur.

Aplikacioni ofron funksione të tjera të dobishme, të tilla si udhëzimet e montimit, mirëmbajtjen dhe kujdesin dhe portalin e shërbimit KÄRCHER.

Nr.	Kodi	Modeli	Fuqia	Presioni	Konsumi	Temp. max	Gjatesia	Cmimi
1	1.673-500.0	K2 Compact	1.4	110 bar	360 l/h	40°C	4 m	<b>14.500</b>
2	1.676-200.0	K3 Compact	1.6	120 bar	380 l/h	40°C	7 m	<b>22.500</b>
3	1.637-500.0	K4 Compact	1.8	130 bar	420 l/h	40°C	8 m	<b>34.500</b>
4	1.324-550.0	K5 Power Control	2.1	145 bar	500 l/h	40°C	10 m	<b>55.900</b>
5	1.324-670.0	K5 Premium Smart Control	2.1	145 bar	500 l/h	40°C	10 m	<b>69.900</b>
6	1.317-200.0	K7 Smart Controll	3	180 bar	600 l/h	60°C	10 m	<b>85.900</b>



**1** **KÄRCHER**

**2** **KÄRCHER**

**3** **KÄRCHER**



**4** **KÄRCHER**

**5** **KÄRCHER**

**6** **KÄRCHER**

**KÄRCHER**

Qese filtri  
4 copë,  
Per aspiratorin  
KÄRCHER  
seritë 'WD 4', 'WD 5', 'WD 6'  
Kodi 2.863-006.0 **Cmimi 3.500 Lek**

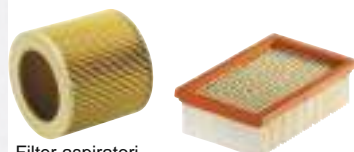

Filter aspiratori  
1 cope për serinë KÄRCHER  
'WD 2', 'WD 3'  
Kodi 2.863-303.0 **Cmimi 3.500 Lek**

Filter aspiratori  
1 cope., për serinë KÄRCHER  
'WD 4', 'WD 5', 'WD 6'  
Kodi 2.863-005.0 **Cmimi 3.900 Lek**

Nr.	Kodi	Modeli	Fuqia	Depozita	Kabell	Pershkrimi	Cmimi
1	1.628-000.0	WD 2 Plus V - 12 / 4 / 18"	1 kW	12 L	1.8 m	Aspirator ne te njome dhe te thate	<b>9.900</b>
2	1.628-101.0	WD 3 V - 17 / 4 / 20"	1 kW	17 L	2 m	Aspirator ne te njome dhe te thate	<b>15.900</b>
3	1.628-135.0	WD 3 S V - 17 / 4 / 20"	1 kW	17 L	2 m	Aspirator ne te njome dhe te thate	<b>17.900</b>
4	1.628-201.0	WD 4 V - 20 / 5 / 22"	1 kW	20 L	2.2 m	Aspirator ne te njome dhe te thate	<b>19.900</b>
5	1.628-300.0	WD 5 V - 25 / 5 / 22"	1.1 kW	25 L	2.2 m	Aspirator ne te njome dhe te thate	<b>27.500</b>
6	1.628-313.0	WD 6 P V - 25 / 8 / 22 / T"	1.3 kW	25 L	2.2 m	Aspirator ne te njome dhe te thate	<b>25.900</b>



**Kodi 1.081-130.0**  
Lavamoket SE 4001  
Fuqia 1.4 kW, Depozite 4 L  
Thithja 21 kPa  
Rrjedhja 70 l/s,  
Zorre 2.5 m, kabell 7.5 m

**ÇMIMI**  
**39.900 Lek**

**Kodi 1.633-212.0**  
Pastruese me bateri 3.6 V  
me avull per xhama dhe pllaka  
Depozite 100 ml

**ÇMIMI**  
**12.500 Lek**

**Kodi 1.512-063.0**  
Pastrues me avull SC 2  
Fuqia 1.5 kW,  
Presioni 3.2 bar

**ÇMIMI**  
**24.900 Lek**



# PASTËRTI MAKSIMALE

vetëm me lavazhet



Blue Clean  
Factor

- 1 Lavazh Annovi AR 144    2 Lavazh Annovi AR 397    3 Lavazh Annovi 4.1 Wi-Touch    4 Lavazh Annovi AR 589

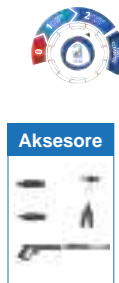

- 1 Lavazh AR 144 me presion të lartë me dorezë dhe rrota që e bëjnë të lehtë lëvizjen. Aksesorë që janë gjithmonë të organizuar dhe gati për t'u përdorur falë kutive speciale të integruara në pjesën e pasme të AR 144 Sistemi i lidhjes së shpejtë: zorra lidhet me makinerinë me një klik.

- 3 Lavazhi me presion të lartë 4.1 Wi-Touch me përmban 2 njësi pompe të cilat mundësojnë performancë të shkëlqyer se sa është e mundur me një model konvencional shtëpie dhe kopshti me një pompë. Një ose të dyja pompat mund të përdoren nga vetë pistoleta, falë sistemit të telekomandës Wi Touch.

- 2 Lavazhet me presion të lartë DSS Series 3.0 PE me presion të lartë AR Blue Clean të pajisura me DSS (Dual Speed System). Falë kësaj teknologjie, të dyja me motorë me dy shpejtësi dhe mund të ofrojnë performanca të ndryshme në varësi të kërkesave, vetëm duke rrotulluar PUNE SWITCH special.

- 4 Lavazhet me presion të lartë Seria 589 janë veçanërisht të përshtatshme për heqjen e papastërtive të thella dhe kokëfortë nga sipërfaqet e mëdha. Këto makineri janë ideale për përdorim të përditshëm dhe gjysmë profesional, duke ofruar performancë të lartë falë motorit të fuqishëm me induksion si dhe koka e pompës prej bronzi dhe aksesorët e klasës profesionale.

Nr.	Kodi	Modeli	Fuqia	Presioni	Konsumi	Temp. max	Gjatesia	Cmimi
1	15000	1 Series AR 144	1.5 kW	120 bar	390 l/h	50°C	5 m	<b>9.900</b>
2	15459	3 Series AR 397	2.2 kW	160 bar	460 l/h	50°C	6 m	<b>19.500</b>
3	15180	DTS Series 4.1 Wi-Touch	2.5 kW	150 bar	810 l/h	50°C	8 m	<b>39.900</b>
4	14989	5 Series AR 589	2.5 kW	170 bar	500 l/h	50°C	10 m	<b>49.900</b>



# TE QËNDRUESHME

## Përballoni çdo punë



### 1 Aspirator Annovi 3770

4 in 1



Lidhje e shpejtë/  
Për pastrimin e  
shpejtë të filtrit dhe  
depozitës

Me 4 rrota  
të qëndrueshme

Prizë elektrike  
me nisje/ndalesë  
automatike

Depozitë  
plastike

Tape për  
shkarkimin  
e lengjeve



MADE IN ITALY

### 2 Aspirator Annovi 2 ne 1

2 in 1



Aksesore



### 3 Aspirator Annovi 4200 P



Aksesore



### 4 Aspirator me 2 motora Annovi 4300 MP

HEAVYPRO



Aksesore



1 Aspirator Annovi 3770 Pastrimi i pluhurit dhe papastërtive ne te njome dhe te thate. Funkcioni i ventilatorit, i krijuar për të pastruar edhe vendet më të vështira për t'u arritur Prizë e veglave elektrike. Falë START/STOP-it të saj automatik, aspiratori ndizet vetëm kur aspiratori është i ndezur, duke e thjeshtuar punën.

2 Aspirator për hirin e zjarrit, soba dhe barbekju si dhe pastrim e papasteritive  
Mentesha me grip për pastrimin e filtrit dhe depozites  
Kornizë çeliku  
Filtiri i palosur me efikasitet të lartë e lahet me mbrojtje metalike Dorezë e integruar  
Gjatësia e kabllit elektrik 1.2 m

3 Aspiratori profesional 4200P Annovi Kompakt i aftë për të siguruar heqjen e përsosur të papastërtive të ngurta, ne sipërfaqe te medha dhe të lëngët. Është një ndihmë ideale veçanërisht për artizanët, duke përfshirë për zdrukthëtarë dhe hidraulikë, si dhe në riparimit të makinave.

4 Aspiratori profesional me 2 motora 4200P Annovi Model profesional kompakt ne te njome dhe te thate.

- Motor me efikasitet të lartë
- Notoni për të ndaluar thithje kur depozita është plot
- Mentesha me grip për pastrimin e filtrit dhe depozites
- Tubi thithës rezistent ndaj përdredhjeve
- Rrotat rrotulluese që nuk shënjajnë

Nr.	Kodi	Modeli	Fuqia	Depozita	Thithja	Cmimi
1	51928	37 Series 3770	1600 W	35 l	19 kPA	<b>17.500</b>
2	52445	E12	600 W	12 l	11 kPA	<b>5.500</b>
3	51061	4200 P	1400 W	36 l	23.5 kPA	<b>29.500</b>
4	52507	4300 MP	2400 W	77 l	20.5 kPA	<b>49.500</b>





## 10 Series 1015

Lavazh industrial Trefazor me aksesore,  
karroce dhe rrota

### HEAVYPRO

#### TE DHENA

- Struktura e qendrueshme çeliku
- 3 pistona te veshura me qeramike te lidhura me sistemin bjelle-kollodok
- By-pass automatik
- Motor 3-fazor
- Valvul kontrolli (Gymatic 3/B - ID)
- Me rregullator presioni
- Me pompe te integruar detergjenti
- Tub i perforcuar me celik (10m)
- Funkсион automatik
- Pistolete me lidhjen e zorres te rrotullueshme

Çmimi  
**199.000**



MOD	KODI	MAX		MAX		MAX		MAX		MAX		MAX		KG NET
		bar max	bar work	psi max	psi work	l/h work	gph work	hp	kW	kW work	rpm	Hz	V	kg
1015	25283-V	230	200	3335	2900	900	238	7,5	5,5	7,4	1450	50	400 3~	60



#### Aksesore lavazhi



KODI	TE DHENA	ÇMIMI
47684	Pistolete lavazhi	3.900
6221	Steke pistolete lavazhi 56cm	2.900
3160590	Tub i perforcuar me rret çeliku 10m	9.900
3086	Koke sprucimi 1/4" 15° 4.5mm	1.990

MADE IN ITALY



## 66 Series 6670

Lavazh industrial  
Trefazor me uje te nxehte

### HEAVYPRO

#### TE DHENA

- Pompe Triplex me 3 pistona te veshura me qeramike te lidhura me sistemin bjelle-kollodok
- By-pass automatik me shkarkim presioni
- Motor me mbrotje termike
- Me celes presioni automatik per fikjen e kaldajes ne mungese te ujit
- Bolier me kazan çeliku me ftohje, me spirale dhe pompe elektrike
- Me mbrotje nga presioni i larte
- Depozite karburanti (22 l)
- Termostat
- Me pompe detergjenti te integruar
- Depozite detergjenti te integruar me kapacitet 3.5/4 l
- Filter uji dhe filter benzine te integruar
- Zorre uji e perforcuar me rret çeliku

Çmimi  
**275.000**



MOD	KODI	MAX		MAX		MAX		MAX		MAX		MAX		KG NET	°C
		bar max	bar work	psi max	psi work	l/h work	gph work	hp	kW	kW work	rpm	Hz	V	kg	Max
6670	25288-V	190	170	2750	2465	780	206	5,5	4	5	1450	50	400 3~	85	110



#### Aksesore lavazhi



KODI	TE DHENA	ÇMIMI
41089	Pistolete lavazhi	3.900
46221	Steke pistolete lavazhi 56cm	2.900
3160160	Tub i perforcuar me rret çeliku 10m	9.900
3082	Koke sprucimi 1/4" 15° 4mm	1.990

MADE IN ITALY



## LLAMBE E27 LED



Designed for  
the comfort  
of your eyes.



Kodi	Potollamba	Fuqia	Ndricimi	Intensiteti i ndricimit	Jetegjatesia	Çmimi
657700	E27	10 W	6500 K	810 lm	20,000 ore	<b>100</b>
657701	E27	12 W	6500 K	1080 lm	20,000 ore	<b>150</b>
657702	E27	15 W	6500 K	1350 lm	20,000 ore	<b>170</b>
657703	E27	18 W	6500 K	1620 lm	20,000 ore	<b>250</b>

## LLAMBE E27 LED



Designed for  
the comfort  
of your eyes.



Kodi	Potollamba	Fuqia	Ndricimi	Intensiteti i ndricimit	Jetegjatesia	Çmimi
657704	E27	20 W	6500 K	2000 lm	35,000 ore	<b>300</b>
657705	E27	30 W	6500 K	3000 lm	35,000 ore	<b>420</b>
657706	E27	40 W	6500 K	4000 lm	35,000 ore	<b>700</b>
657707	E27	50 W	6500 K	5000 lm	35,000 ore	<b>820</b>

## LLAMBE SPOTI LED



Designed for  
the comfort  
of your eyes.



Kodi	Potollamba	Fuqia	Ndricimi	Intensiteti i ndricimit	Jetegjatesia	Çmimi
657708	GU10	4.5 W	4000 K	400 lm	20,000 ore	<b>140</b>
657709	GU10	4.5 W	6500 K	400 lm	20,000 ore	<b>140</b>
657710	GU10	6 W	4000 K	660 lm	20,000 ore	<b>160</b>
657711	GU10	6 W	6500 K	660 lm	20,000 ore	<b>160</b>



## SHIRIT LED 5 M



Designed for  
the comfort  
of your eyes.



Kodi	Tensioni	Fuqja	Ndricimi	Intensiteti i ndricimit	NR LED	Çmimi
657712	12 V/24 V	5 W/M	3000 K	500 lm/m	60 led/m	<b>450</b>
657713	12 V/24 V	5 W/M	4000 K	500 lm/M	60 led/m	<b>450</b>
657714	12 V/24 V	5 W/M	6500 K	500 lm/M	60 led/m	<b>450</b>
657715	12 V/24 V	8 W/M	3000 K	1000 lm/M	120 led/m	<b>550</b>
657716	12 V/24 V	8 W/M	4000 K	1000 lm/M	120 led/m	<b>550</b>
657717	12 V/24 V	8 W/M	6500 K	1000 lm/M	120 led/m	<b>550</b>
657718	12 V/24 V	8 W/M	RGB	1000 lm/M	120 led/m	<b>550</b>
657719	12 V/24 V	14.5 W/M	3000 K	1500 lm/M	240 led/m	<b>990</b>
657720	12 V/24 V	14.5 W/M	4000 K	1500 lm/M	240 led/m	<b>990</b>
657721	12 V/24 V	14.5 W/M	6500 K	1500 lm/M	240 led/m	<b>990</b>

## TRANSFORMATOR LED

- Transformator për të gjitha llojet e shiritave strip, ndriçim led, ekran led.
- Me mbrojtje nga qarku i shkurtër, mbrojtje nga mbingarkesa dhe tension i qëndrueshëm në dalje.
- Efikasitet i lartë dhe temperaturë e ulët.
- Vlerësimi i mbrojtjes: IP20.
- Filtri i integruar EMI.



Kodi	Tensioni	Fuqja	Mbrojtja	Amperazhi	Jetegjatesia	Çmimi
657722	12 V/24 V	60 W	IP20	5 A	20,000 ore	<b>650</b>
657723	12 V/24 V	100 W	IP20	5 A	20,000 ore	<b>850</b>
657724	12 V/24 V	200 W	IP20	7.5-15 A	20,000 ore	<b>990</b>
657725	12 V/24 V	300 W	IP20	12.5-25 A	20,000 ore	<b>1.600</b>
657726	12 V/24 V	400 W	IP20	18-36 A	20,000 ore	<b>2.300</b>
657727	12 V/24 V	500 W	IP20	21-42 A	20,000 ore	<b>2.900</b>
657728	12 V-24 V	36 W	IP20	5A	20,000 ore	<b>1.300</b>

## SPOT INKASO LED

- Trup alumini, i izoluar nga shkarkimi.
- Driver i izoluar 85-265 V.
- Ndricim i larte 29-31 led/m.



Kodi	Dimensioni	Fuqia	Ndricimi	Intensiteti i ndricimit	Jetegjatesia	Çmimi
657729	Ø 70-80 mm	3 W	4000 K	240 lm	25,000 ore	<b>250</b>
657730	Ø 70-80 mm	3 W	6500 K	240 lm	25,000 ore	<b>250</b>
657731	Ø 125-135 mm	9 W	4000 K	720 lm	25,000 ore	<b>380</b>
657732	Ø 125-135 mm	9 W	6500 K	720 lm	25,000 ore	<b>380</b>
657733	Ø 195-210 mm	18 W	4000 K	1440 lm	25,000 ore	<b>650</b>
657734	Ø 195-210 mm	18 W	6500 K	1440 lm	25,000 ore	<b>650</b>

## SPOT JASHT MURI LED

- Trup alumini, i izoluar nga shkarkimi.
- Driver i izoluar 85-265 V.
- Ndricim i larte 29-31 led/m.



Kodi	Dimensioni	Fuqia	Ndricimi	Intensiteti i ndricimit	Jetegjatesia	Çmimi
657735	Ø 120 mm	6 W	4000 K	420 lm	Rrethore	<b>590</b>
657736	Ø 170 mm	12 W	4000 K	840 lm	Rrethore	<b>850</b>
657737	Ø 220 mm	18 W	4000 K	1260 lm	Rrethore	<b>920</b>
657738	Ø 300 mm	24 W	4000 K	1680 lm	Rrethore	<b>1.100</b>
657739	Ø 120 mm	6 W	6500 K	420 lm	Rrethore	<b>590</b>
657740	Ø 170 mm	12 W	6500 K	840 lm	Rrethore	<b>850</b>
657741	Ø 220 mm	18 W	6500 K	1260 lm	Rrethore	<b>920</b>
657742	Ø 300 mm	24 W	6500 K	1680 lm	Rrethore	<b>1.100</b>

## SPOT JASHT MURI LED

- Trup alumini, i izoluar nga shkarkimi.
- Driver i izoluar 85-265 V.
- Ndricim i larte 29-31 led/m.



Kodi	Dimensioni	Fuqja	Ndricimi	Intensiteti i ndricimit	Jetegjatesia	Çmimi
657743	120x120 mm	6 W	4000 K	420 lm	Katrore	<b>590</b>
657744	170x170 mm	12 W	4000 K	840 lm	Katrore	<b>850</b>
657745	220x220 mm	18 W	4000 K	1260 lm	Katrore	<b>920</b>
657746	300x300 mm	24 W	4000 K	1680 lm	Katrore	<b>1.100</b>
657747	600x600 mm	36 W	4000 K	3960 lm	Katrore	<b>2.200</b>
657748	120x120 mm	6 W	6500 K	420 lm	Katrore	<b>590</b>
657749	170x170 mm	12 W	6500 K	840 lm	Katrore	<b>850</b>
657750	220x220 mm	18 W	6500 K	1260 lm	Katrore	<b>920</b>
657751	300x300 mm	24 W	6500 K	1680 lm	Katrore	<b>1.100</b>
657752	600x600 mm	36 W	6500 K	3960 lm	Katrore	<b>2.200</b>

## NDRICUES MAGAZINE LED



Kodi	Dimensioni	Fuqja	Ndricimi	Intensiteti i ndricimit	Jetegjatesia	Çmimi
657753	60 cm	18 W	6500 K	1,500 lm	30,000 ore	<b>300</b>
657754	60 cm	24 W	6500 K	2,600 lm	30,000 ore	<b>400</b>
657755	120 cm	36 W	6500 K	5,300 lm	30,000 ore	<b>600</b>
657756	150 cm	48 W	6500 K	9,000 lm	30,000 ore	<b>1.290</b>



## PROZHEKTOR LED

- Trup alumini dhe xham i temperuar.
- Dizanj i holle me afesi ftohese te larte.
- Mbrojtja nga lageshtia IP65, PF0.9, Ra>80, kend 120 grade.



Kodi	Mbrojtja	Fuqia	Ndricimi	Intensiteti i ndricimit	Jetegjatesia	Çmimi
657757	IP65	10 W	6500 K	2,000 lm	30,000 ore	<b>720</b>
657758	IP65	30 W	6500 K	3,000 lm	30,000 ore	<b>990</b>
657759	IP65	50 W	6500 K	5,000 lm	30,000 ore	<b>1.190</b>
657760	IP65	100 W	6500 K	10,000 lm	30,000 ore	<b>1.990</b>
657761	IP65	150 W	6500 K	15,000 lm	30,000 ore	<b>2.490</b>
657762	IP65	200 W	6500 K	20,000 lm	30,000 ore	<b>3.200</b>

## PROZHEKTOR LED ME PANEL

- Trup alumini dhe xham i temperuar.
- Dizanj i holle me afesi ftohese te larte.
- Mbrojtja nga lageshtia IP65, PF0.9, Ra>80, kend 120 grade.
- Telekomande per vendosjen e modalitetit te ndezjes ne distance



Kodi	Mbrojtja	Fuqia	Ndricimi	Intensiteti i ndricimit	Bateria	Çmimi
657763	IP65	40 W	6500 K	1,050 lm	3.2V-10000mAh	<b>3.500</b>
657764	IP65	60 W	6500 K	1,650 lm	6.4V-10000mAh	<b>4.500</b>
657765	IP65	100 W	6500 K	2,450 lm	6.4V-15000mAh	<b>5.500</b>
657766	IP65	200 W	6500 K	3,100 lm	6.4V-20000mAh	<b>7.500</b>
657767	IP65	300 W	6500 K	4,200 lm	6.4V-25000mAh	<b>9.500</b>



**Tub fleksibel F/F 1/2" 1/2"**

Kodi	Barkodi	Permasa	Çmimi
644-020-12	5907571640305	200 mm	290
644-030-12	5907571640312	300 mm	330
644-040-12	5907571640329	400 mm	360

**Tub fleksibel F/F 1/2" 1/2"**

Kodi	Barkodi	Permasa	Çmimi
644-060-12	5907571640343	600 mm	390
644-080-12	5907571640350	800 mm	420
644-100-12	5907571640367	1000 mm	490



**Tub fleksibel F/F 3/8" 3/8"**

Kodi	Barkodi	Permasa	Çmimi
644-020-38	5907571640374	200 mm	250
644-030-38	5907571640381	300 mm	290

**Tub fleksibel F/F 3/8" 3/8"**

Kodi	Barkodi	Permasa	Çmimi
644-040-38	5907571640398	400 mm	320
644-050-38	5907571640404	500 mm	330



**Tub fleksibel F/F 3/8" 1/2"**

Kodi	Barkodi	Permasa	Çmimi
645-020-38	5907571640442	200 mm	260
645-030-38	5907571640459	300 mm	290
645-040-38	5907571640466	400 mm	350
645-050-38	5907571640473	500 mm	390

**Tub fleksibel F/M 1/2" 1/2"**

Kodi	Barkodi	Permasa	Çmimi
646-030-12	5907571640541	300 mm	320
646-040-12	5907571640558	400 mm	350
646-060-12	5907571640572	600 mm	450
646-080-12	5907571640589	800 mm	450



Cezem per uje te ftohte 1/2"

Kodi	Barkodi	Çmimi
200-020-00	5907571200202	1.790



Cezem per uje te ftohte 1/2" e gjate

Kodi	Barkodi	Çmimi
200-120-00	5907571200219	1.890



Cezem per uje te ftohte me koke spirale e gjate 1/2"

Kodi	Barkodi	Çmimi
201-020-00	5907571200226	1.990



Valvul e rumbullaket 1/2"x 3/8", me leve anesore

Kodi	Barkodi	Çmimi
244-010-00	5907571240055	1.590



Valvul combi 1/2"x3/8"x3/4"

Kodi	Barkodi	Çmimi
244-020-00	5907571240079	1.150



Valvul e rumbullaket 1/2"x 3/8" e gjate

Kodi	Barkodi	Çmimi
244-040-00	5907571240123	1.790



Valvul combi 1/2"x3/8"x3/4"

Kodi	Barkodi	Çmimi
273-010-00	5907571270250	1.490



Saracineske me leve F' / F ' x 1/2" 3/4" x 1

Kodi	Barkodi	Çmimi
700-110-15	5907571700085	750
700-110-20	5907571700092	990
700-110-25	5907571700108	1.590





Saracineske me leve F' / M ' x 1/2" 3/4" x 1

Kodi	Barkodi	Çmimi
700-211-15	5907571700344	990
700-211-20	5907571700351	1.290
700-211-25	5907571700368	2.250



Saracineske Flutur F' / F ' x 1/2" 3/4" x 1

Kodi	Barkodi	Çmimi
700-120-15	5907571700207	790
700-120-20	5907571700214	990
700-120-25	5907571700221	1.690



Saracineske Flutur F' / M ' x 1/2" 3/4" x 1

Kodi	Barkodi	Çmimi
700-220-15	5907571700269	750
700-220-20	5907571700276	990
700-220-25	5907571700283	1.790



Cezem oborri me leve 1/2" - 3/4" - 1

Kodi	Barkodi	Çmimi
704-010-15	5907571700375	650
704-010-20	5907571700382	850
704-010-25	5907571700399	1.250



Mini Saracineske F' / F' X 1/2"

Kodi	Barkodi	Çmimi
703-110-15	5907571700290	650

Mini Saracineske F' / M' X 1/2"

Kodi	Barkodi	Çmimi
703-210-15	5907571700306	550



Saracineske me filter 1/2" X 3/8"

Kodi	Barkodi	Çmimi
707-010-10	5907571700443	550

Saracineske me filter 1/2" X 1/2"

Kodi	Barkodi	Çmimi
707-010-15	5907571700450	590



**Saracineske me filter 1/2" X 3/8" e drejte**

Kodi	Barkodi	Çmimi
707-020-10	5907571700474	450



**Cezem per uje te ftohte 1/2" e gjate**

Kodi	Barkodi	Çmimi
707-020-15	5907571700481	490



**Kundralvul bronzi me suste 1 1/2 x 3/4" me mbyltese plastike**

Kodi	Barkodi	Çmimi
710-000-15	5907571710015	550
710-000-20	5907571710022	690



**Kundralvul bronzi me suste 1" x 1 1/4" me mbyltese plastike**

Kodi	Barkodi	Çmimi
710-000-25	5907571710039	950
710-000-32	5907571710046	1490



**Kundralvul bronzi me suste 1/2" x 3/4" me mbyltese plastike**

Kodi	Barkodi	Çmimi
710-010-15	5907571710107	550
710-010-20	5907571710114	750



**Kundralvul bronzi me suste 1" x 1 1/4" me mbyltese tunxhi**

Kodi	Barkodi	Çmimi
710-010-25	5907571710121	1.100
710-010-32	5907571710138	1.790



**Saracineske gazi me leve 1/2" 3/4" 1" F' / F'**

Kodi	Barkodi	Çmimi
730-110-15	5907571730020	890
730-110-20	5907571730037	1.290
730-110-25	5907571730044	1.890



**Saracineske gazi me leve 1/2" 3/4" 1" F' / M'**

Kodi	Barkodi	Çmimi
730-210-15	5907571730150	950
730-210-20	5907571730167	1.390
730-210-25	5907571730174	1.790



### Koke thermostatike kaloriferi

Kodi	Barkodi	Çmimi
886-520-98	5907571880831	1.150



### Valvul thermostatike kaloriferi e drejte

Kodi	Barkodi	Çmimi
752-010-07	5907571750233	1.250



### Valvul thermostatike kaloriferi me kend

Kodi	Barkodi	Çmimi
752-110-07	5907571750240	1.590



### Valvul kaloriferi tunxh 1/2" e drejte

Kodi	Barkodi	Çmimi
750-060-15	5907571750028	1.350



### Valvul filter bronzi per sistem ngrohje qendror 1/2" x 3/4" 1"

Kodi	Barkodi	Çmimi
720-000-15	5907571720014	490
720-000-20	5907571720021	890
720-000-25	5907571720038	1.190



### Manikote bronzi hollandez F/Mx 1/2" 3/4" x 1"

Kodi	Barkodi	Çmimi
814-010-15	5907571810029	650
814-010-20	5907571810043	990
814-010-25	5907571810050	1.200



### Brryl bronzi F/M 1/2" x 3/4" 1"

Kodi	Barkodi	Çmimi
814-012-15	5907571810104	790
814-012-20	5907571810111	1.200
814-012-25	5907571810128	1.690



### Nipel bronzi Mashkull 3/8" 1/2" 3/4" 1"

Kodi	Barkodi	Çmimi
944-700-10	5907571941006	150
944-700-15	5907571941013	220
944-700-20	5907571941020	290
944-700-25	5907571941037	490





Nipel reduksutese bronzi 3/8" X 1/2" M/M

Kodi	Barkodi	Çmimi
944-710-10	5907571941044	200



Nipel reduksutese bronzi 1/2" X 3/4" M/M

Kodi	Barkodi	Çmimi
944-710-15	5907571941051	250



Nipel reduksutese bronzi 3/4" X 1" M/M

Kodi	Barkodi	Çmimi
944-710-20	5907571941068	490



Manikote bronzi F/F 1/2" - 3/4" - 1"

Kodi	Barkodi	Çmimi
944-720-15	5907571941082	330
944-720-20	5907571941099	390
944-720-25	5907571941105	450



Reduksion hexagonal bronzi 1/2"X3/8" / 3/4"X1/2"

Kodi	Barkodi	Çmimi
944-615-10	5907571941167	150
944-620-15	5907571941174	190



Ti bronzi Femer 1/2" - 3/4" - 1"

Kodi	Barkodi	Çmimi
943-700-15	5907571941204	420
943-700-20	5907571941259	490
943-700-25	5907571941266	650



Bryll bronzi 1/2"X1/2" F/M / 3/4"X3/4" F/M

Kodi	Barkodi	Çmimi
949-020-15	5907571941235	350
949-020-20	5907571941242	550



Bryll bronzi 1"x1" F/M

Kodi	Barkodi	Çmimi
949-020-25	5907571941280	750





Security Tech Germany

Exklusiv bei  
**BAUMARKET**





## DRYN ZINKU SILVER ROCK

### Zink 5 Dryn zinku Silver Rock 5/45 Nano protect

Pershkrimi	Kodi	Permasa	Paketimi	Çmimi
 <p>Dryn bronzi 719/15 S1/ me 2 celsa</p>	79267	45 mm	6 cope	1.990
	79268	50 mm	6 cope	2.490
	79269	55 mm	6 cope	3.490

## DRYN BRONZI 719

### Bronz

Pershkrimi	Kodi	Permasa	Paketimi	Çmimi
 <p>Dryn bronzi 719/15 S1/ me 2 celsa</p>	44216	32 mm	6 cope	850
	44217	33.5 mm	6 cope	850
	44219	43.5 mm	6 cope	1.190
	44221	32 mm	6 cope	1.450
	44224	101 mm	6 cope	1.690
	44225	67.8 mm	6 cope	1.990
	44226	82.5 mm	6 cope	2.900

## DRYN BRONZI MARINE

### Bronz Marine

Pershkrimi	Kodi	Permasa	Paketimi	Çmimi
 <p>Dryn bronzi Marine 717IB45 kundra ujit me 2 celsa</p>	44229	68 mm	6 cope	2.500
 <p>Dryn bronzi Marine 717IB45 kundra ujit HB63 me 2 celsa i gjate</p>	44230	112 mm	6 cope	2.900



## DRYN BRONZI 713

### Bronz

	Pershkrimi	Kodi	Permasa	Paketimi	Çmimi
	Dryn bronzi 713/30 S2	49967	45 mm	6 cope	850
		49968	58 mm	6 cope	990
		49970	64 mm	6 cope	1.490

## DRYN QEPENI

### Titalium S7

	Pershkrimi	Kodi	Permasa	Paketimi	Çmimi
	Dryn qepeni 82TI Monobloc Titalium S7 Blister, kyrcje automatike	24670	70 mm	6 cope	2.990

## DRYN QEPENI BRONZI

### Bronz

	Pershkrimi	Kodi	Permasa	Paketimi	Çmimi
	Dryn qepeni bronzi 722/90 S6/ me 2 cels	44238	50 mm	6 cope	3.300
		44239	61 mm	4 cope	4.990

## DRYN TITALIUM T25TI

### Titalium

	Pershkrimi	Kodi	Permasa	Paketimi	Çmimi
	Dryn Titalium T25TI/50 6 kunjja sigurie S7 me 2 celsa	56589	93 mm	6 cope	2.990

## DRYN TITALIUM 726T ME DY CELESA

### Titalium



Kodi	Pershkrimi	Permasa	Paketimi	Çmimi
56462	726TI/30 S2	45 mm	6 cope	950
56463	726TI/35 S3	48 mm	6 cope	990
56464	726TI/40 S3	60.5 mm	6 cope	1.200
56468	T26TI/50 S5	68 mm	6 cope	1.690

## DRYN TITALIUM 726T

### Titalium



Kodi	Pershkrimi	Permasa	Paketimi	Çmimi
56467	Set me 3 dryna Titalium T26TI/40 S3/ & 3 celsa	60.5 mm	6 cope	2.990

### Titalium



Kodi	Pershkrimi	Permasa	Paketimi	Çmimi
56466	Set me 2 dryna Titalium T26TI/40 S3/ & 2 celsa	60.5 mm	6 cope	1.990

### Titalium



Kodi	Pershkrimi	Permasa	Paketimi	Çmimi
56465	Dryn Titalium 726TI/40HB63 S4/ 1 gjate me 2 celsa	99 mm	6 cope	1.350

## DRYN ALUMINI ME 3/4 KODE SIGURIE S2

### Silver



Kodi	Pershkrimi	Permasa	Paketimi	Çmimi
52675	3 kode sigurie	52.5 mm	12 cope	1.390
52683	3 kode sigurie	65 mm	12 cope	1.450



Kodi	Pershkrimi	Permasa	Paketimi	Çmimi
52693	Dryn alumini silver me 4 kode sigurie S3	77 mm	6 cope	1.490

## DRYN BRONZI ME 3 KODE SIGURIE S2



Kodi	Pershkrimi	Permasa	Paketimi	Çmimi
44210	3 kode sigurie	52.5 mm	12 cope	1.690
44211	3 kode sigurie	65 mm	12 cope	1.900

## DRYN ALUMINI ME 4 KODE SIGURIE S2



44212	Dryn bronzi me 4 kode sigurie S3	90 mm	6 cope	2.900
-------	----------------------------------	-------	--------	-------

## SIGURES DERE ME DRYN



Kodi	Pershkrimi	Permasa	Paketimi	Çmimi
01448	100/100 S4	100 mm	6 cope	1.350
01438	100/80 S4	80 mm	6 cope	950

## SIGURES DERE ME DRYN ME KAPESE SHITESH S4



Kodi	Pershkrimi	Permasa	Paketimi	Çmimi
01453	100/100G	160 mm	6 cope	1.990
01443	100/80G	125 mm	6 cope	1.390

## SIGURES DERE ME DRYN TE LEVIZSHEM



### Titalium



Kodi	Pershkrimi	Permasa	Paketimi	Çmimi
01619	200/115	115 mm	6 cope	890
01613	200/95	95 mm	6 cope	690
01607	200/75	75 mm	6 cope	550



## FISHEK BRAVE NIKEL D6N

### Nikel

### Pershkrimi

### Kodi

### Permasa

### Paketimi

### Çmimi

- Fishek brave Nikel D6N, me 6 kunjë sigurie, 5 celesa dhe karte me kod.
- Cilinder me perforcim shtese kunder shpimit.
- Pre-Snap function - mbrojtje kunder thyerjes se cilindrit.
- Rezistent ndaj korrozionit per elementet e brendshem.

81588	30/30 - 60 mm	10 cope	2.590
81589	30/40 - 70 mm	10 cope	2.690
69411	30/60 - 90 mm	10 cope	2.990
81590	35/35 - 70 mm	10 cope	2.690
81592	40/40 - 80 mm	10 cope	2.890
81593	40/50 - 90 mm	10 cope	2.990
69419	40/60 - 100 mm	10 cope	2.990
69424	50/50 - 100 mm	10 cope	2.990
69412	30/70 - 100 mm	10 cope	2.990
81596	50/60 - 110 mm	10 cope	2.990

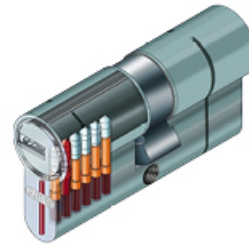

## FISHEK BRAVE NIKEL KD6N

### Nikel

### Pershkrimi

### Kodi

### Permasa

### Paketimi

### Çmimi

- Fishek brave Nikel KD6N, me 6 kunjë sigurie, 5 celesa, kunjë nga nje ane dhe karte me kod.
- Cilinder me perforcim shtese kunder shpimit.
- Pre-Snap function - mbrojtje kunder thyerjes se cilindrit.
- Rezistent ndaj korrozionit per elementet e brendshem.

81607	30/30 - 60 mm	10 cope	2.990
81608	30/40 - 70 mm	10 cope	2.990
61611	40/40 - 80 mm	10 cope	3.300
81613	40/50 - 90 mm	10 cope	3.600
81617	50/50 - 100 mm	10 cope	3.900

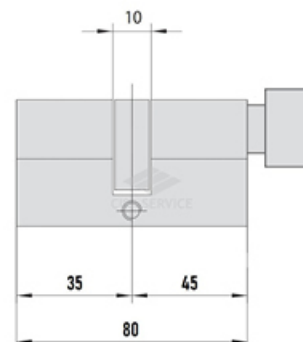

## FISHEK BRAVE NIKEL PERL E60NP

Nikel	Pershkrimi	Kodi	Permasa	Paketimi	Çmimi
<ul style="list-style-type: none"> <li>Fishek brave Nikel E60NP,</li> <li>Me funksion mbrojtje nga goditja dhe emergjence me 5 kunj dhe 3 celesa,</li> <li>Niveli 7 i sigurise</li> <li>paketimi blister</li> </ul> 		55009	30/30 - 60 mm	5 cope	2.990
		55010	30/35 - 65 mm	5 cope	2.990
		54148	30/40 - 70 mm	5 cope	2.990
		57220	30/50 - 80 mm	5 cope	2.990
		54865	35/35 - 70 mm	5 cope	2.990
		54867	40/40 - 80 mm	5 cope	2.990
		54868	40/50 - 90 mm	5 cope	2.990
		39343	50/50 - 100 mm	5 cope	2.990



## FISHEK BRAVE NIKEL D45N

Nikel	Pershkrimi	Kodi	Permasa	Paketimi	Çmimi
<ul style="list-style-type: none"> <li>Fishek brave Nikel D45N,</li> <li>me 5 kunj dhe 5 celesa,</li> <li>Niveli 6 i sigurise</li> <li>sistem anti shpim,</li> <li>paketimi blister</li> </ul> 		79435	30/30 - 60 mm	6 cope	1.790
		79437	30/40 - 70 mm	6 cope	1.890
		79439	30/50 - 80 mm	6 cope	1.990
		79440	35/35 - 70 mm	6 cope	1.890
		79446	40/40 - 80 mm	6 cope	2.050
		78841	40/50 - 90 mm	6 cope	2.200
		79449	40/60 - 100 mm	6 cope	2.350
		79455	50/50 - 100 mm	6 cope	2.350
		79457	50/60 - 110 mm	6 cope	2.450



## FISHEK BRAVE NIKEL / KD45N

Nikel	Pershkrimi	Kodi	Permasa	Paketimi	Çmimi
<ul style="list-style-type: none"> <li>Fishek brave Nikel KD45N,</li> <li>Me leve nga 1 ane,</li> <li>Me 5 kunj,</li> <li>Niveli 6 i sigurise</li> <li>Sistem anti shpim,</li> <li>Paketim blister</li> </ul> 		90506	28/36 - 64 mm	6 cope	2.250
		79459	30/30 - 60 mm	6 cope	2.250
		79461	30/40 - 70 mm	6 cope	2.350
		90509	30/50 - 80 mm	6 cope	2.490
		79462	40/40 - 80 mm	6 cope	2.490

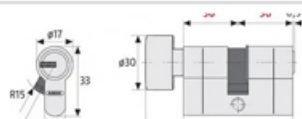

## SY MAGJIK SILVER

Silver

Kodi	Pershkrimi	Kendi	Paketimi	Çmimi
------	------------	-------	----------	-------



32906	Sy magjik silver 35-53mm lente plastike	180°	6 cope	1.290
-------	---	------	--------	-------

## SY MAGJIK DIXHITAL

Kodi	Pershkrimi	Kendi	Paketimi	Çmimi
------	------------	-------	----------	-------



388255	Sy magjik dixhital, 38-110 mm me bateri AAA	105°	1 cope	19.900
--------	---	------	--------	--------

## EKRAN PER SY MAGJIK DIXHITAL

Kodi	Pershkrimi	Ekrani	Bateri	Çmimi
------	------------	--------	--------	-------



203299	I pershtatshem per dyer me trashesi 38-110mm	3.2"	4AAA	18.900
--------	--	------	------	--------

## SY MAGJIK DIXHITAL

Kodi	Pershkrimi	Kendi	Paketimi	Çmimi
------	------------	-------	----------	-------



388248	Sy magjik dixhital, 38-110 mm me 3 nivele zile	105°	1 cope	18.900
--------	--	------	--------	--------

## EKRAN PER SY MAGJIK DIXHITAL

Kodi	Pershkrimi	Ekrani	Bateri	Çmimi
------	------------	--------	--------	-------



788048	I pershtatshem per dyer me trashesi 38-110mm	2.8"	4AAA	17.900
--------	--	------	------	--------



## MEKANIZEM HIDRAULIK PER DYER

Silver



Kodi	Pershkrimi	Permasa	Paketimi	Çmimi
83314	Mekanizem hidraulik per dyer 40-65KG, krah, me shtejtesi mbyllje te rregullueshme	850 - 950 mm	6 cope	4.500

## MEKANIZEM HIDRAULIK PER DYER PANIKU

Silver



Kodi	Pershkrimi	Permasa	Paketimi	Çmimi
83315	Mekanizem hidraulik per dyer paniku 40-80KG, krah, me shtejtesi mbyllje te rregullueshme	850 - 1100 mm	1 cope	7.500

## MEKANIZEM HIDRAULIK PER DYER

Silver



Kodi	Pershkrimi	Permasa	Paketimi	Çmimi
83230	Mekanizem hidraulik per dyer 40-85KG, krah me shtejtesi dhe force mbyllje te rregullueshme	850 - 1100 mm	1 cope	8.500

## SIGURESE DERE ME CELES

Plastik



Kodi	Pershkrimi	Ngjyra	Paketimi	Çmimi
78778	Sigurese dere me celes 2110/ 5kunja sigurie. 2 celesa e bardhe/ blister	E bardhe	2 cope	3.900

## SENSOR TYMI I JASHEM



Kodi	Pershkrimi	Diametri	Ngjyra	Çmimi
372421	Sensor tymi i jashtem, per ambiente 40 m2 i bardhe	Ø 100 mm	E bardhe	3.990



Kodi	Pershkrimi	Diametri	Ngjyra	Çmimi
093869	Sensor tymi i jashtem, me dedektor nxehtesie me batteri 3V,	Ø 105 mm	E bardhe	6.990

## ALARM GAZI METANI



Kodi	Pershkrimi	Permasa	Ngjyra	Çmimi
814433	Alarm gazi metani 4W i bardhe	115 x 75 x 36.5 mm	E bardhe	7.990

## KUTI CELESASH ALUMINI



Kodi	Pershkrimi	Çmimi
40264	Kuti celesash alumini murale me kombinim 4 shifror deri ne 7 celsa	3.900

## KUTI CELSASH METALIKE



Kodi	Pershkrimi	Çmimi
46331	Kuti celsash metalike murale me kombinim 4 shifror deri ne 20 celsa	6.500



**Pershkrimi** *Kavo sigurie biciklele me kod S3*

Kodi	Permasa	Paketim	Çmimi
80368	75cm / 15mm	3 cope	3.500



**Pershkrimi** *Kavo sigurie biciklele S12 / S8 / S6 / 2 celsa*

Kodi	Ngjyra	Permasa	Paketim	Çmimi
80373	Jeshile	65cm 6mm / S12	12 cope	790
80369	Roze	65cm 12.5mm / S8	8 cope	1.750
80370	E zeze	65cm 12.5mm / S6	6 cope	1.750



**Pershkrimi** *Kavo sigurie biciklele me kod S8 / S12*

Kodi	Ngjyra	Permasa	Paketim	Çmimi
80371	Portokalli	65cm / 10mm S8	8 cope	1.990
80375	Jeshile	65cm / 6mm S12	12 cope	790



**Pershkrimi** *Zinxhir sigurie biciklele me kod S6*

Kodi	Ngjyra	Permasa	Paketim	Çmimi
80379	I zi	60cm / 4mm	6 cope	1.590
80380	I zi	110cm / 4mm	6 cope	1.790



**Pershkrimi** *Zinxhir sigurie biciklele me 2 celsa S6*

Kodi	Ngjyra	Permasa	Paketim	Çmimi
80381	I zi	60cm / 4mm	6 cope	1.590
80382	I zi	110cm / 4mm	6 cope	1.790



**Pershkrimi** *Zinxhir sigurie biciklele / motorciklele me 2 celsa S2*

Kodi	Ngjyra	Permasa	Paketim	Çmimi
80383	I kuq	85cm / 6mm	2 cope	4.200
80385	I zi	110cm / 6mm	2 cope	4.690



**Pershkrimi** *Kavo mbyllese biciklele forme U me 2 celsa S3*

Kodi	Ngjyra	Permasa	Paketim	Çmimi
80401	I zi	230mm	3 cope	4.900



**Pershkrimi** *Kabull sigurie biciklele UV me dryn*

Kodi	Ngjyra	Permasa	Paketim	Çmimi
80407	I zi	200 cm 10 mm	3 cope	2.500



**Pershkrimi** *Zinxhir sigurie biciklele / motorciklele me dryn S6*

Kodi	Ngjyra	Permasa	Paketim	Çmimi
80409	I zi	85cm / 6mm	6 cope	2.200
80410	I zi	110cm / 6mm	6 cope	2.500



## KOKORE BIKIKLETE ME LED

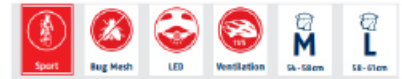

**Pershkrimi** *Kokore biciklete me Led me ventilim dhe kundra insekteve*

	Kodi	Masa	Ngjyra	Permasa	Çmimi
	78829	M	E bardhe	54-58cm	5.990
	78830	L	E bardhe	58-61cm	5.990
	78833	M	E zeze	54-58cm	5.990
	78832	L	E zeze	58-61cm	5.990

## KOKORE BIKIKLETE PER ADOLESHENT



**Pershkrimi** *Kokore biciklete per adoleshent me ventilim*

	Kodi	Masa	Ngjyra	Permasa	Çmimi
	69336	S	Blu e shendritshme	54-58cm	5.990
	69338	M	Blu e shendritshme	51-55cm	5.990

## KOKORE BIKIKLETE PRO LED PER FEMIJE



**Pershkrimi** *Kokore biciklete Pro Led per femije me ventilim*

	Kodi	Masa	Ngjyra	Permasa	Çmimi
	69341	S	Blu Sharky	45-50cm	4.990
	69342	M	Blu Sharky	50-55cm	4.990

## KOKORE BIKIKLETE PER FEMIJE



**Pershkrimi** *Kokore biciklete per femije me ventilim dhe kundra insekteve*

	Kodi	Masa	Ngjyra	Permasa	Çmimi
	80338	S	Blu oqean	45-50cm	3.500
	80337	M	Blu oqean	50-55cm	3.500
	80340	S	Lule roze	45-50cm	3.500
	80339	M	Lule roze	50-55cm	3.500

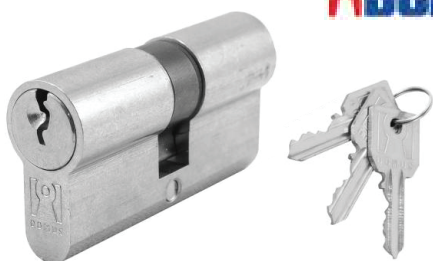
**Ekskluzive në****BAUMARKET**Funksion kunder  
thyerjesMe 5 kunjë  
sigurieMe perforues shtese  
kunder shpimit**DOMUS****FISHEK BRAVE NIKELI, ME 5 KUNJA SIGURIE,  
3 CELESA**

Kodi		Çmimi
11054KE	54mm (27-27)	<b>990</b>
16060KE	60mm (30-30)	<b>990</b>
16170K	70mm (35-35)	<b>1.150</b>
16075KE	75mm (30-45)	<b>1.150</b>
16180K	85mm (40-40)	<b>1.250</b>
16190K	90mm (30-60)	<b>1.350</b>
16190K	90mm (40-45)	<b>1.390</b>
16095K	95mm (45-50)	<b>1.490</b>
160100K	100mm (30-70)	<b>1.590</b>

**DOMUS****FISHEK BRAVE NIKELI ECON, ME 5 KUNJA  
SIGURIE, 5 CELESA**

Kodi		Çmimi
21065K	54mm (27-27)	<b>1.950</b>
21075K	60mm (30-30)	<b>1.990</b>
21083K	70mm (35-35)	<b>2.150</b>
21090K	75mm (30-45)	<b>2.250</b>
21095K	85mm (40-40)	<b>2.450</b>
210100K	90mm (30-60)	<b>2.550</b>
211100K	90mm (40-45)	<b>2.650</b>
210110K	95mm (45-50)	<b>2.750</b>
210120K	100mm (30-70)	<b>2.850</b>

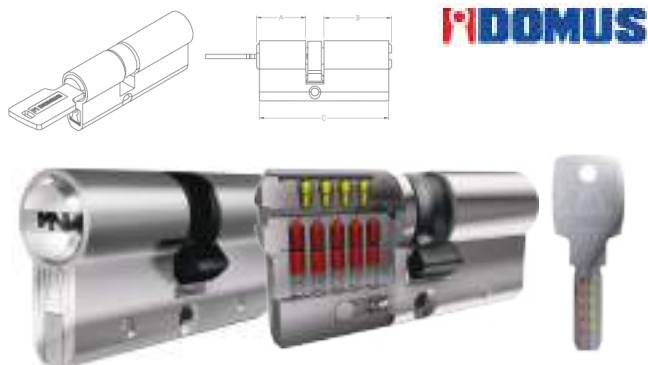
**DOMUS****FISHEK BRAVE NIKELI ALFA, ME 9 KUNJA  
SIGURIE, 5 CELESA**

24065K	65mm (30-35)	<b>2.790</b>
24075K	75mm (30-45)	<b>2.990</b>
24083K	83mm (30-53)	<b>3.250</b>
24090K	90mm (30-60)	<b>3.450</b>
240100K	100mm (30-70)	<b>3.550</b>
241100K	100mm (35-65)	<b>3.550</b>

**DOMUS****BRAVE QEPENASH ME FISHEK DHE 3 CELESA**

Kodi		Çmimi
16240K	40mm (30-10)	<b>990</b>

**DOMUS****BRAVE QEPENASH ME FISHEK DHE 3 CELESA**

Kodi		Çmimi
96250L	Mbyllja majtas	<b>2.650</b>
96250R	Mbyllja djathtas	<b>2.650</b>

**DOMUS**

**MEKANIZEM BLOKIM BRAVE ME 3 VENDE**

Kodi		Çmimi
93635	35mm	7.500
94430	30mm	6.900
94435	35mm	6.900
94435XE	35mm	8.900

**DOMUS**

**MEKANIZEM BLOKIM BRAVE ME 5 VENDE**

Kodi		
94635	35mm	7.500

**DOMUS**

**SET ME 4 PLLAKA PER MEKANIZEM BLOKIMI BRAVE ME 5 VENDE**

Kodi	Çmimi
94685	650

**DOMUS**

**BRAVE DYERSH ME GREP**

Kodi		Çmimi
95016E	16mm cilinder oval 54mm, nikel	2.250
95030C	30mm pa cilinder oval 54mm, nikel	1.390
95120	20mm cilinder 54mm, bronxi	2.900
95135	35mm cilinder 54mm, bronxi	2.950

**DOMUS**

**MEKANIZEM HAPES DYERSH ELEKTRIK**

Kodi		Çmimi
9901FE	Standart	3.350
9902FE	Me lirim permanent	3.450
9904FE	Me rregullim dhe lirim permanent	3.750

**DOMUS**

**SET DOREZE DERE ME ROZETE, INOKS**

Kodi		Çmimi
6000X	60x30x62x58mm	2.900





**DOMUS**

**SET DOREZE DYER ALUMINI E KTHYER, ME ROZETE, E BARDHE**

Kodi		Çmimi
6130L	75x35x57x70mm	1.890



**DOMUS**

**SET DOREZE DYER ALUMINI E KTHYER, ME ROZETE, E ZEZE**

Kodi		Çmimi
6130M	75x35x57x70mm	1.890



**DOMUS**

**SET DOREZE DYER ALUMINI ME ROZETE, E ZEZE**

Kodi		Çmimi
6110M	75x35x57x70mm	1.890



**DOMUS**

**SET DOREZE DYER ALUMINI ME ROZETE, I BARDHE**

Kodi		Çmimi
6110L	75x35x57x70mm	1.890
6150L	ovale / 75x35x57x70mm	1.790



**DOMUS**

**SET DOREZE DYER ALUMINI ME ROZETE EURO, I BARDHE**

Kodi		Çmimi
6210L	75x35x57x70mm	1.790



**DOMUS**

**SET DOREZE DYER ALUMINI ME ROZETE EURO, E ZEZE**

Kodi		Çmimi
6210M	75x35x57x70mm	1.790



**DOMUS**

**SET DOREZE DERE DYER ALUMINI ME ROZETE, I BARDHE**

Kodi	Çmimi
6310L	990



**DOMUS**

**SET DOREZE DERE DYER ALUMINI ME ROZETE, I ZI**

Kodi	Çmimi
6310M	990



**DOMUS**

**DOREZE DYERSH ALUMINI, E BARDHE**

Kodi	Çmimi
6340L	1.190



**DOMUS**

**DOREZE DYERSH ALUMINI, E ZEZE**

Kodi	Çmimi
6340M	1.190



**DOMUS**

**KYC SIGURIE DRITARESH ALUMINI RRESHQITASE, E BARDHE**

Kodi	Çmimi
6461L	set me 2 siguresa 650
6462L	set me 2 siguresa 950



**DOMUS**

**SHUL DERE, SISTEM WK+ 194x63x39.6x18mm**

Kodi	Ngjyrat	Çmimi
6470L	I bardhe	2.350
6470M	I zi	2.350
6470X	Kaf	2.350
6470Z	Gri	2.350



**DOREZE E KTHYER ALUMINI PER DRITARE  
33x126x65mm**

Kodi	Ngjyrat	Çmimi
6900L	E bardhe	1.450
6900M	E zeze	1.450



**DOREZE ALUMINI PER DRITARE ME DOREZE  
TE KTHYER 33x126x65mm**

Kodi	Ngjyrat	Çmimi
6930L	E bardhe	1.450
6930M	E zeze	1.450



**DOREZE ALUMINI PER DRITARE, OVALE, E BARDHE**

Kodi	Çmimi	
6950L	33x126x65mm	1.390



**BRAVE BRONZI PER DRITARE ALUMINI**

Kodi	Çmimi	
7400B	175x35x198x17mm	350



**BRAVE DRITARESH TE RRESHQITSHME ME BUTON  
ME KUNJE 28x186 mm**

Kodi	Ngjyrat	Çmimi
7610L	I bardhe	950
7610M	I zi	950
7610X	Kaf	950
7610Z	Gri	950



**BRAVE DRITARESH TE RRESHQITSHME ME BUTON  
ME VIDE**

Kodi	Çmimi	
7620L	2x186mm	1.350





**BRAVE DRITARESH TE RRESHQITSHME ME DOREZE  
180° / 2x186mm**

Kodi	Ngjyrat	Çmimi
7650L	I bardhe	1.190
7650M	I zi	1.190
7650X	Kaf	1.190
7650Z	Gri	1.190



**BRAVE DRITARESH TE RRESHQITSHME ME BUTON  
28X186mm**

Kodi	Ngjyrat	Çmimi
7710L	I bardhe	1.590
7710M	I zi	1.590
7710X	Kaf	1.590
7710Z	Gri	1.590



**BRAVE DRITARESH TE RRESHQITSHME ME  
CILINDER DHE CELES, I BARDHE**

Kodi	Ngjyrat	Çmimi
7720L	28x186mm	1.850



**BRAVE ME KYC SIGURIE ME LEVE PER DRI-  
TARE/DYER ALUMINI E BARDHE 180°**

Kodi	Ngjyrat	Çmimi
7815L	32x200mm	1.990



**KIT BRAVE DRITARESH TE RRESHQITSHME  
32x200mm**

Kodi	Ngjyrat	Çmimi
7800L	E bardhe	1.590
7800M	E zeze	1.590



**BRAVE ME KYC SIGURIE DRYERSH/DRITARESH  
ALUMINI 32x200mm**

Kodi	Ngjyrat	Çmimi
7810L	E bardhe	890
7810M	E zeze	890



**MEKANIZEM SIGURIE INOXI I BRENDSHEM PER BRAVA DRITARESH/DYERSH ALUMINI**

Kodi	Ngjyrat	Çmimi
7901X	Profil 30-42mm	690



**DOREZE E RROTULLUESHME 180° PER DYER TE RRESHQITSHME 30x200mm**

Kodi	Ngjyrat	Çmimi
790NL	E bardhe	2.200
790NM	E zeze	2.200



**DOREZE E BARDHE ME MBYLLJE PER DRITARE DYER ALUMINI 30x200mm**

Kodi	Ngjyrat	Çmimi
7910L	E bardhe	1.550
7910M	E zeze	1.550



**BRAVE DYERSH TE BRENDSHME BRONZI ME 2 CELESA**

Kodi	Permasa	Ngjyrat	Çmimi
80140	40-75mm	Bronzi	1.250
8044B	40-72mm	Bronzi	990
80540	40-75mm	E kromuar	1.390



**BRAVE DYERSH TE BRENDSHME PA FINITURE**

Kodi	Ngjyrat	Çmimi
80640	40-70mm	690
80740	40-75mm	950
80940	40-90mm	790



**MEKANIZME BRAVE DYERSH TE BRENDSHME ECON LINE**

Kodi	Permasa	Ngjyrat	Çmimi
81140	40-75mm	Bronzi	950
81245	45-72mm	Bronzi	950
81940	40-90mm	Bronzi	950

**DOMUS**

**BRAVE DYERSH TE BRENDSHME BRONZI**

Kodi	Permasa	Çmimi
8094B	40-90mm	<b>990</b>
82140	Ovale 40-75mm	<b>1.250</b>

**DOMUS**

**MEKANIZME BRAVE DYERSH TE BRENDSHME OVALE, ECON LINE**

Kodi	Permasa	Çmimi
83140	Econ Line 40-75	<b>950</b>
83940	Econ Line 40-90	<b>950</b>

**DOMUS**

**BRAVE DYERSH TE BRENDSHME 20 MM ME FISHEK BRONZI DHE 3 CELESA**

Kodi	Cilindri	Çmimi
90120A	54mm bronzi	<b>1.990</b>

**DOMUS**

**PLLAKE PER BRAVE DYERSH ALUMINI, E KROMUAR**

Kodi	Permasa	Çmimi
901800	20mm	<b>100</b>

**DOMUS**

**PLLAKE PER BRAVE DYERSH ALUMINI ME RREGJISTRIM, E KROMUAR**

Kodi	Çmimi
90185	<b>190</b>
90185XE	<b>650</b>

**DOMUS**

**PLLAKE PER BRAVE DYERSH ALUMINI E KROMUAR EUROPA**

Kodi	Çmimi
904830	<b>350</b>





**BRAVE DYERSH DRURI TE BLINDUARA ME FISHEK DHE 3 MBYLLJE + 5 CELSA**

Kodi	Permasa	Çmimi
9054C	45x71x85x23mm	<b>2.990</b>



**BRAVE DYERSH TE BRENDSHME ME FISHEK DHE 3 CELESA**

Kodi	Permasa	Çmimi
90845	45mm, bronzi	<b>2.750</b>
90845CR	45mm, kromuar	<b>2.950</b>



**BRAVE DYERSH TE JASHTME ALUMINI E KROMUAR**

Kodi	Permasa	Ngjyrat	Çmimi
91125A	25mm	I kromuar, fishek 54mm	<b>1.990</b>
91125C	25mm	I kromuar	<b>1.150</b>
91130C	30mm	I kromuar	<b>1.450</b>
91135C	35mm	I kromuar	<b>1.450</b>
91140T	40mm	I kromuar	<b>1.850</b>
91145T	45mm	I kromuar	<b>1.950</b>



**BRAVE DYERSH ALUMINI E KROMUAR ME VRIME**

Kodi	Permasa	Çmimi
91735T	35mm/vrima 16 mm	<b>1.490</b>



**BRAVE DYERSH ME KYC RROTULLUES TE BRENDSEM E KROMUAR**

Kodi	Permasa	Çmimi
92130C	30mm	<b>1.590</b>
92135C	35mm	<b>1.590</b>



**SET ME 3 PLLAKA INOXI PER BRAVE DYERSH ME RREGULLIM**

Kodi	Permasa	Çmimi
93485	E kromuar	<b>550</b>
93485XE	Inox	<b>1.150</b>

**PISTOLETE UJI BRONZI ME 2 FUNKSIONE**



**PISTOLETE UJI ME KOKE DUSHI BRONZI ME 7 FUNKSIONE**

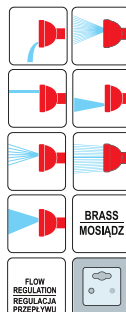

**TRIPOD ALUMINI PER VADITJE ME GJEL DHE KAPJE 1/2"**



Kodi	Kapja	Çmimi
YT-8967	Universale	<b>1.990</b>

Kodi	Kapja	Çmimi
YT-8968	Universale	<b>1.990</b>

Kodi	Kapja	Çmimi
YT-8984	1/2"	<b>2.990</b>

**ELEKTROSHARRE 2000W ZINXHIR 56DH 3/8"**

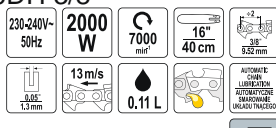

**KARRUKULL UJI PLASTIKE PER 50 M TUB**



**KARRUKULL UJI PLASTIKE ME DOREZE**



Kodi	Fuqia	Çmimi
YT-84870	2000 W	<b>8.900</b>

Kodi	Permasa	Çmimi
YT-99850	50 m	2.990

Kodi	Permasa	Çmimi
YT-99852	50 m	<b>5.500</b>

**SPERKATES METALIK 360GRADE**

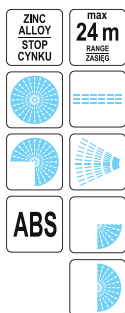

**SPERKATES METALIK ME 6 LLOJE SPRUCIMESH**

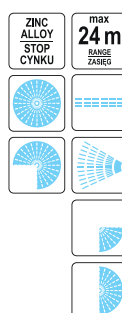

**GERSHERE SHARTIMI DHE KRASITJE 2 NE 1 NE CANTE + AKSESORE**



Kodi	Gjatesia	Çmimi
YT-8985	240 mm	<b>690</b>

Kodi	Gjatesia	Çmimi
YT-8986	240 mm	<b>990</b>

Kodi	Tehu	Çmimi
YT-88505	SK5	<b>1.950</b>

GERSHERE KRASITËSE  
DIA PRERJE 5/8"



GERSHERE KRASITËSE  
DIA PRERJE 1"



GERSHERE KRASITJE  
ME BY-PASS 8'



Kodi	Gjatesia	Çmimi
YT-8800	205 mm	<b>590</b>

Kodi	Fija	Çmimi
YT-8801	220 mm	<b>750</b>

Kodi	Diametri	Çmimi
YT-8802	200 mm	<b>750</b>

GERSHERE LULESH 8"



GERSHERE RRUSHI  
LULESH



GERSHERE LIGUSTRASH  
10"X4.0MM



Kodi	Permasa	Çmimi
YT-8808	200 mm	<b>750</b>

Kodi	Permasa	Çmimi
YT-8817	190 mm	<b>590</b>

Kodi	Permasa	Çmimi
YT-8823	625 mm	<b>1.990</b>

GERSHERE BARI 8  
POZICIONE, 360°

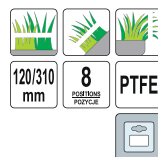

FRYRESE DHE THITHESE  
GJETHESH ELEKTRIKE  
VOLUM 13.2M3/MIN



SET ME 4 RAKORDERI  
VADITJE ME PISTOLETE



Kodi	Permasa	Çmimi
YT-8852	310 mm	<b>990</b>

Kodi	Fuqia	Çmimi
YT-85180	3500 W	<b>4.900</b>

Kodi	Permasa	Çmimi
YT-99831	1/2 & 3/4	<b>390</b>



THIKE 32CM PER KORRESE  
BARI 9.5-5.5MM



KOKE METALIKE ME FIJE  
9.5MM



KOKE METALIKE ME FURCE TE  
ASHPER PER MOTOKOSA



Kodi	Gjatesia	Çmimi
YT-85160	320 mm	<b>750</b>

Kodi	Fija	Çmimi
YT-85111	2.2-3.0 mm	<b>650</b>

Kodi	Diametri	Çmimi
YT-85142	200 mm	<b>890</b>

SHARRE KRASITJE



SHARRE KRASITJE



SHARRE KRASITJE



Kodi	Permasa	Çmimi
YT-87725	180 mm	<b>990</b>

Kodi	Permasa	Çmimi
YT-87730	180 mm	<b>990</b>

Kodi	Permasa	Çmimi
YT-87731	210 mm	<b>1.150</b>

SHARRE KRASITJE



SHARRE KRASITJE



SHARRE KRASITJE ME  
HARK



Kodi	Permasa	Çmimi
YT-87732	250 mm	<b>1.250</b>

Kodi	Permasa	Çmimi
YT-87740	350 mm	<b>1.590</b>

Kodi	Permasa	Çmimi
YT-87744	350 mm	<b>1.890</b>



- Kontrolli elektronik, kontrollon në mënyrë të përsosur fuqinë në varësi të rezistencës së punës, duke siguruar kështu një jetë të gjatë shërbimi dhe rezultate optimale të prerjes.
- Përdorimi i një motori pa karbonçina i zhvilluar dhe prodhuar në Gjermani rezulton në me pak nxehtësi, një jetë më të gjatë shërbimi të baterisë dhe kështu një jetë më të gjatë shërbimi të përgjithshëm për përdoruesin.
- Me buton elektronik për tju mbrojtur nga nderzja aksidentale.

**GT684**

Gershëre delesh me bateri Li-Ion 3500 mAh, 2700rpm, Motor pa karbonçina/ blu

Çmimi

**89.000**



- Motori Aesculap, i cili u zhvillua dhe u prodhua në Gjermani, mund të kapërcejë çdo pengesë, pavarësisht sa e madhe, dhe lejon që makineria të rrëshqasë vazhdimisht nëpër shtresë.
- Shpejtësi e lartë e prerjes dhe motor me fuqi të lartë.
- Nxehtësi e ulët falë çarkullimit të lartë të ajrit.

**GT694**

Gershëre delesh 200W, 2750rpm, 5m kabell, blu

Çmimi

**59.900**







- Për përdorim të veçantë në fushën veterinare me një grup tehe për prerje afër lëkurës me cilësi të provuar Aesculap.
- Shpejtësi e lartë prerjeje për prerje precize dhe te lehte.
- Bateri e fuqishme e ringarkueshme me teknologji Litium Ion
- Funkionim pa lodhje për shkak të peshës jashtëzakonisht të ulët

Çmimi

**35.000**

#### GT454-NB

Gershëre kafshesh me bateri Li-Ion 2850 mAh, 3300rpm, Motor pa karboncina, blu



- Motori Aesculap, i cili u zhvillua dhe u prodhua në Gjermani, mund të kapërcejë çdo pengesë, pavarësisht sa e madhe, dhe lejon që makineria të rrëshqasë vazhdimisht nëpër shtresë
- Shpejtësi e lartë e prerjes dhe motor me fuqi të lartë
- Nxehhtësi e ulët falë qarkullimit të lartë të ajrit

Çmimi

**59.900**

#### GT474

Gershëre kafshesh Profesionale 200W set me 1 lame rezerve, 2750rpm, 5m kabell, blu





- Gershere me bateri per qen, inovative dhe e fuqishme per perdorim profesional.
- "InfoLED Display" i integruar tregon statusin e karikimit të baterisë, si dhe udhëzimet e vajit dhe pastrimit në çdo kohë.
- Fuqi e madhe prerëse me 3300 goditje, falë motorit pa karbonçina me cilësi të lartë.
- Ergonomike dhe e ekuilibruar perfekt.
- Pesha prej vetëm 390 g për punë pa lodhje.

Çmimi

**35.000**

#### GT234-SR

Gershere per qen me bateri Li-Ion 2850 mAh, 3500rpm, Motor pa karboncina, e kuqe



- E fuqishme, e qetë, e besueshme dhe e qëndrueshme.
- Funkzionimi me dridhje të ulët.
- Prodhuar në Gjermani - i fuqishëm dhe shumë afatgjatë.
- Rezultate të qëndrueshme, prerjeje të mira.
- I përshtatshëm për funksionim të vazhdueshëm.
- Me mbrojtje nga mbinxehja.
- Lehtësisht i perdorshem, edhe me nje dore.

Çmimi

**39.900**

#### GT101

Gershere per qen 30W, 2300rpm, 5m kabell, e kuqe



**7.500**

119817  
Kosh Mbeturinash 50L portokalli



**7.500**

119816  
Kosh Mbeturinash 50L gjelbërt



**3.900**

119816  
Kosh Mbeturinash CityBac® klasik  
80L hiri



**3.900**

119819  
Kosh Mbeturinash CityBac® klasik  
80L jeshil



**4.900**

119824  
Kosh Mbeturinash CityBac® klasik  
120L hiri-kaltërt



**4.900**

119820  
Kosh Mbeturinash CityBac® klasik  
120L hiri



**4.900**

119821  
Kosh Mbeturinash CityBac® klasik  
120L jeshil



**4.900**

119822  
Kosh Mbeturinash CityBac® klasik  
120L hiri-kuq



**4.900**

119823  
Kosh Mbeturinash CityBac® klasik  
120L hiri-verdhë



**5.500**

119826  
Kosh Mbeturinash CityBac® klasik  
120L i kaltërt



**5.500**

119827  
Kosh Mbeturinash CityBac® klasik  
120L i kuq



**5.500**

119831  
Kosh Mbeturinash CityBac® klasik  
120L i verdhë



**5.500**

119825  
Kosh Mbeturinash CityBac® klasik  
120L e kaffe



**6.900**

119828  
Kosh Mbeturinash CityBac® klasik  
240L hiri



**49.000**

119830  
Kosh Mbeturinash CityBac® klasik  
660L hiri



**69.000**

124553  
Kosh Mbeturinash 1100L i gjelbërt



**69.000**

119829  
Kosh Mbeturinash CityBac® klasik  
1100L hiri





Ekskluzive në  
**BAUMARKET**

### ZT17846

#### Rimokio Rex25

Ngarkesa: 500 kg, me një Aks, pa frenim.  
Zonë ngarkimi e pjerrët për ngarkim dhe shkarkim të lehtë.  
Dera e pasme e lëvizshme dhe panelet anësore.  
Rimorkio e aksesueshme nga dera e pasme.  
Dysheme e perpunuar, që nuk rrëshqet me 6 nyje lidhëse. Shasi e fortë e bërë nga çelik i galvanizuar.



Cmimi

**235.000**

### ZT17846

#### Rimokio BH-R 750 me mbulesë të gomuar

Ngarkesa: 608 kg, mjet me një Aks, dimensionet :  
201 x 108 x 110 cm, me mbulesë, pa frena.  
Rimorkio me pëlthure të gomuar të lartë të lëvizshme.  
Vëllim më i lartë i ngarkimit dhe mbrojtja e ngarkesës nga moti.  
Kangjella me vrima të integruara, për sigurimin e lehtë të ngarkesës.  
12 vjet garanci kundër ndryshkjes.  
Shasi e galvanizuar dhe e fiksuar me bulona.

Cmimi

**135.000**



### 23618

#### Rimokio BH 7.5-20-12.1

Ngarkesa: 627 kg, mjet me një Aks, dimensionet:  
201 x 117 x 30 cm, pa frena. Rimorkio ideale për përdorim të rastësishëm dhe punë të lehta. Transporton pa mundim rrënojat e ndërtesave, mbeturinat e gjelbra, mobiljet dhe shumë më tepër. Kornizë e fortë, e galvanizuar dhe perforcuar me shirit tërthor. Dysheme e perpunuar, që nuk rrëshqet dhe e papërshkueshme nga uji.

Cmimi

**79.900**





24224.001

**Rimorkio BASIC SH 2000-25-13.2**

Ngarkesa: 1,642 kg, Aks i dyfishhtë, dimensionet: 251 x 128 x 35 cm, me frena. Mbeshtetes të ngushtë dhe të lartë. Mure anësore të palosshme dhe të lëvizshme. Dizajn me dy akse, për ngarkesë më të madhe. Jetegjatesi shërbimi falë shasisë së galvanizuar. Shpejtesia e miratuar 100 km/h.



Çmimi  
**375.000**



**ZT14721**

Komplet rampe per rimorkio 2 copë, 149 x 20 cm ideale për ngarkimin e kositësve të barit, karrocave dhe shumë më tepër. Mund të ngjitet në shumë rimorkio standarde. Mund të mbajë deri në 300 kg për shina. Materiali i montimit i përfshirë.

Çmimi  
**14.900**



**T3404217**

Pajisja kundër vjedhjes Safety-Box II i përshtatshëm për rimorkio makinash. Sigurimi i rimorkios së makinës kur shkëputet Strehimi metalik i galvanizuar. Mbrojtje shumë e mirë ndaj korrozionit. Përfshin bravë të rumbullakët me 2 çelësa.

Çmimi  
**5.900**



**ZT00420**

Rrot mbështetëse Kapaciteti: 150 kg, çeliku i galvanizuar Rrota mbështetëse e qëndrueshme deri në 150 kg. Lartësia e rregullueshme deri në 22 cm. Përfshirë kapëse për ngjitjen në shiritin e tërheqjes. Goma te forta me veshje plastike 200mm.

Çmimi  
**5.900**



**ET0000424**

Set kabulli kryesor i përshtatshëm. Përmasat e brendshme të kutisë së rimorkios 201x108cm. Pjesë rezervë e rëndësishme për shumë rimorkio. Lidhës me pin 7 shifror për lidhje me automjetin. Instalim i lehtë me kapëse kablosh. Lidhje e lehtë me dritat e pasme. Përfshirë 10 kapëse shasi me dritat e pasme. Përfshirë 10 kapëse shasi.

Çmimi  
**6.900**



### Robot pishine me bateri Steinbach Poolrunner+

Pastrues pishine



- Bateria 12.6V
- Kapaciteti 6.600 mAh
- Thellesia 2m, per 18 m<sup>2</sup>
- Pompa 10.000 l/h

**55.000**

061013

### Robot pishine me bateri Steinbach Bpro

Pastrues pishine



- Bluetooth
- Bateria 12.6V
- Kapaciteti 8.600 mAh,
- Thellesia 2m, per 32 m<sup>2</sup>
- Pompa 10.000 l/h

**99.000**

061206F11

### Roboti pishine me bateri Steinbach Poolrunner Basic

Pastrues pishine



- Bluetooth
- Bateria 2.0, 12.6 V
- Kapaciteti 2.600 mAh,
- Thellesia 2m, per 10 m<sup>2</sup>
- Pompa 6.000 l/h

**24.900**

061205

### Robot pishine Steinbach S 63

Pastrues pishine



- Fuqia 150 W
- Thellesia 2m, per 18 m<sup>2</sup>
- Pompa 16.000 l/h

**39.900**

061007

### Robot pishine Steinbach Poolrunner

Pastrues pishine



- Fuqia 150 W
- Thellesia 2m, per 32 m<sup>2</sup>
- Pompa 15.000 l/h

**59.000**

061014

### Robot pishine Steinbach Poolrunner twin

Pastrues pishine











- Fuqia 200 W
- Thellesia 2m, per 50 m<sup>2</sup>
- Pompa 20.000 l/h

**99.000**

061025



<p><b>Termometer Dixhital per pishinën</b></p> <p>Termometer</p>  <p><b>2.990</b></p>	<p><b>Termometer pishine C° / °F DUCK</b></p> <p>Termometer</p>  <p><b>1.500</b></p>	<p><b>Set pastrimi pishine (7 cope)</b></p> <p>Set pastrimi</p>  <p><b>4.900</b></p>
<p>061333</p>	<p>061326</p>	<p>061175</p>
<p><b>Rrjete Pastrimi</b></p> <p>Rrjete pastrimi</p>  <p><b>2.900</b></p>	<p><b>Rrjete Pastrimi per pishine</b></p> <p>Rrjete pastrimi</p>  <p><b>3.600</b></p>	<p><b>Furçe pastrimi per veshjen së pishinës 45cm</b></p> <p>Furçe pastrimi</p>  <p><b>2.900</b></p>
<p>061105</p>	<p>061115</p>	<p>061120</p>
<p><b>Pastrues Trekendor për dyshemënë e pishinës</b></p> <p>Pastrues pishine</p>  <p><b>2.900</b></p>	<p><b>Shkop teleskopik alumini per rrjeta / furca pastrimi pishine me zgjatim 1.2-3.6m</b></p> <p>Shkop teleskopik</p>  <p><b>3.900</b></p>	<p><b>Set pastrimi pishine DELUXE (8 cope)</b></p> <p>Pastrues pishine</p>  <p><b>6.900</b></p>
<p>061155</p>	<p>061190</p>	<p>28003</p>

AKSESORE PISHINASH

**Pishine e jashtme e rumbullaket**

Pishine e jashtme



- Permasa 183x51cm
- Ngjyra blu
- Kapacitet 886L

**4.500**

**28101**

**Pishine e jashtme e rumbullaket**

Pishine e jashtme



- Permasa 244cmX76cm
- Ngjyra blu
- Kapacitet 3070L

**6.500**

**28110**

**Pishine e jashtme e rumbullaket**

Pishine e jashtme



- Permasa 305cmX76cm
- Ngjyra blu
- Kapacitet 3900L

**8.500**

**28120**

**Set pishine e jashtme e rumbullaket me filter**



- Permasa 457cmx457cmx84cm
- Ngjyra blu
- Kapacitet 9800L

**27.500**

**28158**

**Pishine e jashtme me mbeshtetese anesore**



Kodi	Përmasa	Çmimi
28270	220cmx150cmx60cm	13.500
28271	260cmx160cmx65cm	14.900

**Pishine e jashtme me mbeshtetese anesore**



Kodi	Përmasa	Çmimi
28272	300cmx200cmx75cm	17.900
28273	450cmx220cmx84cm	29.900



**Set pishine e jashtme me filter dhe shkalle hyrese**



- Permasa 300cmx175cmx80cm
- Ngjyra blu
- Kapacitet 3539L

**49.900**

**26784**

**Set pishine e jashtme me mbeshtetese anesore, me filter, 2 mbulesa dhe shkalle hyrese**



- Permasa 457cmx122cm
- Ngjyra blu
- Kapacitet 16805L

**75.000**

**28242**

**Set pompe me 2 filtra uji per pishina te jashtme**



**5.900**

**604G**

**Pishine e jashtme per femije Gator**



- Permasa 201cmx170cmx84cm
- Kapacitet 159L

**6.900**

**57165**

**Pishine e jashtme per femije Qender Peshkimi**



- Permasa 218cmx188cmx99cm
- Kapacitet 182L

**7.900**

**57162**

**Pishine e jashtme per femije Aventure Xhungle**



- Permasa 244cmx198cmx71cm
- Kapacitet 492L

**10.900**

**57161**



## Varke SEAHAWK SET per 2 persona



Varke SEAHAWK

• Permasa 236cmx114cmx41cm

**9.900**

68347

## Varke SEAHAWK SET per 3 persona



Varke SEAHAWK

• Permasa 295cmx137cmx43cm

**16.500**

68380

## Varke SEAHAWK SET per 3 persona



Varke SEAHAWK

• Permasa 351cmX145cmX48cm

**19.900**

68351

## Varke MARINER SET per 4 persona



Varke MARINER

• Permasa 328cmX145cmX48cm

**69.900**

68376

## Varke CHALLENGER SET per 2 persona



• Permasa 236cmX114cmX41cm

**8.900**

68378



**Padle up Set**  
350 x 86 x 15 cm

**75.000**

# ENGINEERED IN GERMANY MADE IN AUSTRIA / ITALIA



**GERMANY**  
KÖTZ



**AUSTRIA**  
OBDACH



**ITALIA**  
REGGIO EMILIA

Kompania jonë ofron një gamë të gjerë të veglave të kopshtit dhe bujqësisë për të përmbushur nevojat e gjëra të përdoruesve. PREMIUM PRO ofron teknologji dhe performancë të përparuar për aplikime të vështira. COMFORT PRO ofron zgjidhje të rehatshme nga markat me te njohura. EASY PRO siguron pajisje të lehta dhe të fuqishme për të apasionuarit dhe mirëmbajtjen e kopshteve dhe lëndinave të mesme.

## **PREMIUM***pro*

Me veglat PREMIUM PRO, ju sigurisht do të përmirësoni cilësinë e punës në kopshtari dhe bujqësi. Duke ofruar teknologji dhe performancë të përparuar, veglat e kësaj game janë zgjidhja e duhur për kushte të ndryshme të punës. Nga kultivimi i tokës deri te kujdesi për kopshtin tuaj, veglat PREMIUM PRO ofrojnë një nivel të lartë të efikasitetit dhe lehtësisë së përdorimit. Ju merni vetëm më të mirën nga markat SOLO, FELCO, OREGON, SPERONI, GARDENA, KRAUSE, MINOS NIK, ANNOVI REVERBERI, etj.

- ✓ FUSHA BUJQËSORE DHE FERMA PRODHIMI
- ✓ KOPSHTË TË MËDHENJ DHE LËNDINA
- ✓ SIGURI E LARTË TEKNIKE
- ✓ TIPARE INOVATIVE DHE SMART
- ✓ TË QËNDRUESHËM PËR KËRKESA PROFESIONALE

## **COMFORT***pro*

Punë e thjeshtë, komode falë funksionalitetit më të lartë dhe paisjeve profesionale me veçori inovative. Me markat AL-KO, McCULLOCH, EINHELL, NAKAYAMA, KAMIKAZE, LAUNTOP, FITT, BORMANN, kjo është ajo që ju premtojmë në kategorinë tonë COMFORT PRO. Performanca ideale dhe qëndrueshmëria e provuar sigurojnë rezultate të shpejta pune që është mbresëlënëse.

- ✓ KOPSHTË TË MËDHENJ
- ✓ QËNDRUESHMËRI E LARTË
- ✓ TIPARE INOVATIVE
- ✓ PËR KËRKESA TË LARTA

## **EASY***pro*

Produkte për kopshte të mesme dhe të mëdha nga markat INGCO, FORCE, CELLFAST, VOREL, sepse kur ka shumë punë për të bërë, ajo që ka rëndësi është lehtësia e përdorimit, fleksibiliteti dhe funksionet shtesë, që e bëjnë cdo hap më të lehtë. Me produktet tona në kategorinë EASY PRO, jeni gjithmonë të mirëpërgatitur.

- ✓ KOPSHTË TË MESËM
- ✓ TË SHPEJTË DHE TË LEHTË
- ✓ FUNKSIONALITETE SHITESË
- ✓ PAISJE PËR TË APASIONUARIT







**Korrese bari dhe  
Aksesore**



**Motokosa, Elektrokosa  
dhe Aksesore**



**Krasitese Ligustrash,  
Fryrese Gjethesh  
dhe Motosharra**



**Freza, Turriela  
dhe Sperkaese**



**Pompa Uji, Motopompa  
dhe Gjeneratore**



**Lavazhe, Aspiratore  
dhe Lavamoket**



**Gershere Krasitje,  
Tuba uji, Karroca  
dhe Rakorderi**



**Shkalle, Skela, Rafta  
Metalike, Karrela dhe  
Karroca Dore**



**Produkte Elektrike  
dhe Hidraulike**



**Produkte Familjare  
dhe Outdoor**



Korrese bari me bateri  
Korrese bari elektrike  
Korrese bari me benzine  
Traktor me benzine  
Aksesore motosharre

Vaj motori  
Set aksesoresh  
Mbjatese thike  
Set rrotash  
Zgjatues kabulli



**06-24**  
**1**

Motokosa me bateri  
Motokosa me benzine  
Aksesore elektrokose  
Vaj motokose  
Elektrokosa

Koke motokose  
Disk Motokose  
Fije Motokose  
Paisje mrojtese  
Rrip per mbajtje



**25-42**  
**2**

Krasitese ligustrash  
Krasitese elektrike  
Krasitese me benzine  
Shpata  
Zinxhire

Fryrese gjethesh me bateri  
Fryrese gjethesh elektrike  
Fryrese gjethesh me benzine  
Motosharre me bateri  
Elektroshtarre



**43-68**  
**3**

Traktor me nafte  
Freza toke me nafte  
Freze toke me benzine  
Aksesore freze  
Turrojele me benzine

Sperkatese me bateri  
Sperkatese me benzine  
Sperkatese mekanike  
Aksesore sperkatesesh  
Steka sperkatje



**69-86**  
**4**

Pompe presioni  
Pompe volumetrike  
Pompe centrifugale  
Pompe zhytесе  
Pompe pusi

Motopompe me benzin  
Gjenerator me benzin  
Gjenerator silencioz  
Gjenerator me nafte  
Kuader elektrik



**87-120**  
**5**

Lavazh me bateri  
Lavazhe familjar  
Lavazhe profesional  
Aspirator me bateri  
Aspirator elektrik

Pastruese me avull  
Lavamoket  
Aksesore per lavazhe  
dhe aspiratore  
Bombul shkume



**121-135**  
**6**

Gershere me bateri  
Gershere mekanike  
Sharra krasitje  
Sharre teleskopike  
Gershere ligustrash

Karroce uji  
Zorra uji  
Rakorderi uji  
Aksesore vaditje  
Furca per larje

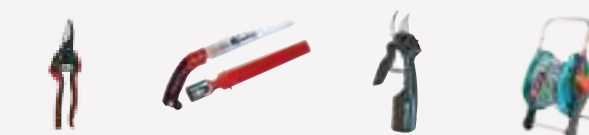

**136-186**  
**7**

Shkalle familjare  
Shkalle profesionale  
Shkalle alumini  
Shkalle metalike  
Shkalle druri

Skela  
Karrela  
Karroce dore  
Rafta me kate  
Aksesore sinjalistike

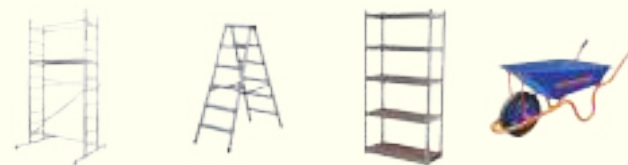

**187-210**  
**8**

Ndricues  
Spote  
Shirit LED  
Projektor  
Baladez

Priza/Adaptor  
Set dushi  
Rubinet Lavamani  
Mishelator  
Rakorderi hidraulike



**211-272**  
**9**

Fisheke  
Celesa  
Doreze  
Dryn  
Kasaforte

Barbekju  
Elektroshtepiake  
Nderese rrobash  
Aksesore outdoor  
Set ndenje per kopesht



**273-323**  
**10**

# Korrëse Robotike GARDENA

Korrëse bari inteligjente robotike, SILENO.

Kositëset robotike të barit GARDENA janë pajisje inteligjente që paraqesin Full Connect, AI-precize dhe Auto Weather & Terreni dhe janë më të qetat në klasën e tyre. SILENO-t tanë inteligjentë përfshijnë një pjesë të harduerit të quajtur Inteligjenca LONA™ që mundëson lokalizimin dhe navigimin e makinës suaj robotike të barit.\* Zbuloni të ardhmen niveli i kujdesit inteligjent të lëndinës me gjurmimin e vendndodhjes, hartën e kopshtit, menaxhimin e zonave, mbrojtjen e zonës dhe shumë më shumë veçori që do të vijjnë.



## Lidhje direkte

Lidhje direkte me sistemin Inteligent Smart. Kujdesuni për kopshtin tuaj kudo që të jeni.



Inteligjencë e përmirësuar me

**LONA™**  
Intelligence

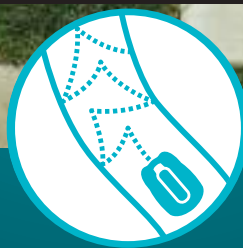

## Prerje preçize

Roboti LONA™ mëson, skicon dhe përshtatet me kopshtin tuaj individual.







### Prerje silencieze

Me i qeti në klasën e tij.



### Të pandikuar nga moti dhe terreni

SILENO punon në çdo mot në shi, diell në kopësht të thjeshtë dhe kompleks.

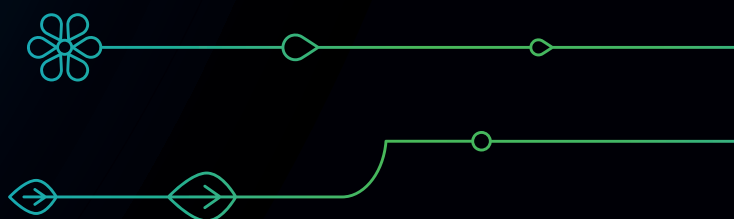





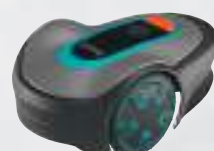

**S** Për kopësht të vogël





Të dhëna	SILENO minimo	SILENO minimo
Per sipërfaqe	Deri ne 250 m <sup>2</sup>	Deri ne 500 m <sup>2</sup>
Aksesoret	150 m tel rrethues, 150 grepa, 4 ciftezuese, 5 bashkuese	150 m tel rrethues, 150 grepa, 4 ciftezuese, 5 bashkuese
Parametrat	-	-
Sistemi baterise	Bateri Lithium-ion	Bateri Lithium-ion
Pjerresia maksimale	Deri ne 25%	Deri ne 25%
Rregullimi i lartesisë se prerjes	20-45 mm	20-45 mm
Pesha	6.5 kg	6.5 kg
Siguria	Kod Pin	Kod Pin
Pastrimi me tub uji	•	•
Niveli i zhurmes, dB(A)	57 (dB)A	57 (dB)A
Prerje ne korridore te ngushta	•	•
Sensor ngrirje	•	•
Prerje e perqendruar	•	•
Koha e korrjes dhe karikimit	5.5 h	12.0 h
Kodi modelit me Bluetooth 	15201-32	15202-32
Kodi modelit Smart 	-	-
<b>Çmimi</b>	<b>79.000</b>	<b>99.000</b>

**M** Për kopësht mesatar



Të dhëna	SILENO life	SILENO life
Për sipërfaqe	Deri ne 1250 m <sup>2</sup>	Deri ne 1500 m <sup>2</sup>
Aksesorët	250 m tel rrethues, 300 grepa, 4 ciftezuese, 5 bashkuese	250 m tel rrethues, 300 grepa, 4 ciftezuese, 5 bashkuese
Parametrat	•	•
Sistemi baterisë	Bateri Lithium-ion	Bateri Lithium-ion
Pjerresia maksimale	Deri ne 35%	Deri ne 35%
Rregullimi i lartesisë se prerjes	20-50 mm	20-50 mm
Pesha	8.3 kg	8.3 kg
Siguria	Kod Pin, alarm	Kod Pin, alarm
Pastrimi me tub uji	•	•
Niveli i zhurmes, dB(A)	57 (dB)A	57 (dB)A
Prerje ne korridore te ngushta	•	•
Sensor ngrirje	•	•
Prerje e perqendruar	•	•
Koha e korrjes dhe karikimit	19.0 h	22.5 h
Kodi modelit me Bluetooth 	15103-32	15108-32
Kodi modelit Smart 	-	-
<b>Çmimi</b>	<b>149.000</b>	<b>179.900</b>

 Kontrolloni nëpërmjet aplikacionit GARDENA Bluetooth®. Pa pagesë për t'u shkarkuar, pa tarifa abonimi, i disponueshëm për smartphone dhe tablet. Kërkesat: smartphone ose tablet Android ose iOS me funksion Bluetooth®.

 Kontrolloni nëpërmjet aplikacionit inteligjent GARDENA\*\*. Pa pagesë për t'u shkarkuar, pa tarifa abonimi, i disponueshëm për smartphone, tablet dhe ueb. Kërkesat: router Wi-Fi dhe akses në internet, smartphone, tablet ose kompjuter. \*\*\* Për maksimum. zona – vlera të përafërta, në varësi të formës së kopshit, lëndinës dhe kushteve mjedisore dhe moshës së baterisë.

# AKSESORË SILENO



Garazhi i korreseve Robotike Sileno

**Kodi** 15020-20  
**Cmimi** **26.500**



Kit per mirembajtjen, pastrimin e korreseve Robotike Sileno

**Kodi** 4091-20  
**Cmimi** **2.100**



Kuti per mbrojtjen ndaj ftohtit te korreseve Robotike Sileno

**Kodi** 4056-20  
**Cmimi** **2.350**



Thika prerje per korrese Robotike Sileno

**Kodi** 4087-20  
**Cmimi** **2.690**



Kit konektoresh per lishje elektrike per korreseve Robotike Sileno

**Kodi** 4089-20  
**Cmimi** **2.100**



Kunja per korreset Robotike Sileno

**Kodi** 4090-20  
**Cmimi** **2.450**

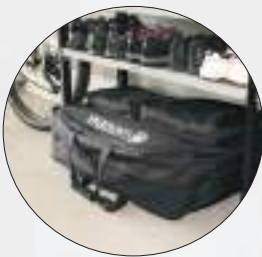

Cante magazinimi per korreset Robotike Sileno

**Kodi** 4057-20  
**Cmimi** **8.590**



Varese ne mur per korreset Robotike Sileno

**Kodi** 4045-60  
**Cmimi** **8.590**



Furca per rrota per korreset Robotike Sileno

**Kodi** 4030-20  
**Cmimi** **3.490**



Kit (Kunja + tel + lidhese shtrimi per korreset Robotike Sileno

**Kodi** 4059-60  
**Cmimi** **3.690**



Tel shtrimi i perforcuar 50 m per korreset Robotike Sileno

**Kodi** 4058-60  
**Cmimi** **4.690**



Tel shtrimi i perforcuar 150 m per korreset Robotike Sileno

**Kodi** 4088-60  
**Cmimi** **11.900**





## KORRESE BARI ME BATERI

- | PowerMax 37/36V
- | Motori 36V
- | Me 2 bateri 18 V / 4.0 Ah
- | Gjeresi prerje 37 cm
- | Koshi 45 L

Kodi : 14638-20

**ÇMIMI**  
**59.900 Lek**

**MADE IN GERMANY**



## KORRESE BARI ME BATERI

- | 4757 Li SP
- | Bateri 42 V / 7.5 Ah Lithium-Ion
- | Me funksion te copezimit te barit dhe shkarkim anesore
- | Gjeresi prerje 46 cm

Kodi : 127414

**ÇMIMI**  
**99.900 Lek**

**MADE IN GERMANY**



## KORRESE BARI ME BATERI

- | Moweo 42.0 Li
- | Per lendina deri ne 400 m<sup>2</sup>
- | Bateri 40 V / 5.0 Ah
- | Motor pa karboncina
- | Doreze ergonomike
- | Gjeresi prerje 42 cm

Kodi : 119933

**ÇMIMI**  
**66.900 Lek**

**MADE IN GERMANY**



## KORRESE BARI ME BATERI

- GE-CM 18/30 Li
- Me 1 bateri 18 V / 3.0 Ah
- Koshi: 25 L
- Gjeresi prerje: 30 cm
- Pa karboncina

Kodi : 34.131.55

**ÇMIMI**  
**19.500 Lek**



1  
2  
3  
4  
5  
6  
7  
8  
9  
10

### KORRESE BARI ME BATERI

- | Motori 40 V, pa karboncina
- | Gjeresia e prerjes 51 cm
- | Me 2 bateri 20 V / 5.0 Ah
- | Koshi 60 lt
- | Shasi metalike

Kodi : LMLI2022

**ÇMIMI**  
**39.900 Lek**

**INGCO**  
Professional Tools Made Affordable

**P20S**  
**BL MOTOR**



**INGCO**  
Professional Tools Made Affordable

**P20S**  
**BL MOTOR**

### KORRESE BARI ME BATERI

- | Motori 40 V, pa karboncina
- | Gjeresia e prerjes 46 cm
- | Me 2 bateri 20 V / 5.0 Ah
- | Lartesia e prerjes e regullueshme 30-80 mm
- | Koshi 60 lt
- | Shasi metalike
- | Me 3 funksione

Kodi : LMLI20186

**ÇMIMI**  
**29.900 Lek**

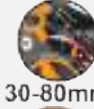

**INGCO**  
Professional Tools Made Affordable

**P20S**  
**BL MOTOR**

### KORRESE BARI ME BATERI

- | Motori 40 V, pa karboncina
- | Gjeresia e prerjes 46 cm
- | Me 2 bateri 20 V / 5.0 Ah
- | Koshi 60 lt
- | Shasi metalike

Kodi : LMLI20182

**ÇMIMI**  
**27.900 Lek**



**INGCO**  
Professional Tools Made Affordable

**P20S**  
**BL MOTOR**

### KORRESE BARI ME BATERI

- | Motori 40 V
- | Koshi 30 L
- | Gjeresi prerje : 34 cm
- | Lartesia e prerjes e regullueshme 20-70 mm
- | Vetem trup

Kodi : LMLI2014

**ÇMIMI**  
**11.900 Lek**







# GARDENA PowerMax Korrëse bari elektrike

Të fuqishme dhe ergonomike

Kositëset tona elektrike PowerMax™ ofrojnë mbulim optimal të barit dhe rezultate të shkëlqyera prerjeje falë motorit të fuqishëm PowerPlus dhe tehut dyfishhtë të përforcuar DuraEdge.



## KORRESE BARI

- | PowerMax 42E
- | Koshi: 45 L
- | Gjeresi prerje : 42 cm
- | Fuqia 1800 W
- | Per sip. deri ne 800 m<sup>2</sup>
- Kodi : 5042-20**

**ÇMIMI**  
**26.900 Lek**



## KORRESE BARI

- | PowerMax 37E
- | Koshi: 45 L
- | Gjeresi prerje : 37 cm
- | Fuqia 1600 W
- | Per sip. deri ne 500 m<sup>2</sup>
- Kodi : 14637-20**

**ÇMIMI**  
**24.900 Lek**



### Dorezë ergonomike e harkuar

Përdorim i thjeshtë. Doreza **ErgoTec** siguron fleksibilitet gjatë punës dhe mundëson përdorimin e korrëses në një pozicion natyral të dorës.



### Motor PowerPlus

Motori me fuqi të lartë dhe moment të lartë rrotullimi që jep rezultate precize prerjeje. Veçanërisht efikase për një jetë shumë të gjatë shërbimi.

Më shumë bar i mbledhur në koshin e pasëm falë qarkullimit të mirë të ajrit, që do të thotë zbrazje më e rallë dhe kursim kohe.



**KORRESE BARI**



- | PowerMax 1200/32
- | Koshi: 30 L
- | Gjeresi prerje : 32 cm
- | Fuqia 1200 W
- | Per sip. deri ne 300 m<sup>2</sup>

Kodi : 14633-20

**ÇMIMI**  
**14.900 Lek**



**KORRESE BARI**



- | PowerMax 1100/32
- | Koshi: 29 L
- | Gjeresi prerje : 32 cm
- | Fuqia 1100 W
- | Per sip. deri ne 250 m<sup>2</sup>

Kodi : 5031-20

**ÇMIMI**  
**13.500 Lek**



**KORRESE BARI**



- | 3.82 SE
- | Koshi: 37 L
- | Gjeresi prerje : 38 cm
- | Fuqia 1400 W
- | Per sip. deri ne 550 m<sup>2</sup>

Kodi : 112856

**ÇMIMI**  
**12.900 Lek**



**KORRESE**



- | 3.22 SE
- | Koshi: 30 L
- | Gjeresi prerje : 32 cm
- | Fuqia 1000 W
- | Per sip. deri ne 250 m<sup>2</sup>

Kodi : 112805

**ÇMIMI**  
**9.900 Lek**



**KORRESE BARI**



- | Motor me induksion
- | Koshi: 50 L
- | Gjeresi prerje : 38 cm
- | Fuqja 1600 W
- Kodi : LM383

**ÇMIMI**  
**14.900 Lek**



**KORRESE BARI**



- | Koshi: 45 L
- | Gjeresi prerje : 38 cm
- | Fuqja 1600 W
- | Lartesia e prerjes: 28 / 48 / 68mm
- Kodi : LM385

**ÇMIMI**  
**9.900 Lek**



**KORRESE BARI**



- | Koshi: 28 L
- | Gjeresi prerje : 32 cm
- | Fuqja 1200 W
- | Per sip. deri ne 300 m<sup>2</sup>
- Kodi : LM321

**ÇMIMI**  
**7.500 Lek**



**KORRESE BARI**



- | Koshi: 30 L
- | Gjeresi prerje : 32 cm
- | Fuqja 1000 W
- | Per sip. deri ne 300 m<sup>2</sup>
- Kodi : 34.002.57

**ÇMIMI**  
**7.900 Lek**



1  
2  
3  
4  
5  
6  
7  
8  
9  
10



## KORRESE BARI ELEKTRIKE

- | Gjeresi prerje : 33cm
- | Lartesia: 20-60mm
- | Koshi : 30 Lt
- | Fuqja : 1300 W
- Kodi : WEN3205

**CMIMI**  
**7.500 Lek**



## KORRESE BARI ELEKTRIKE

- | Gjeresi prerje : 32cm
- | Lartesia: 25-65mm
- | Koshi : 30 Lt
- | Fuqja : 1200 W
- Kodi : WEN3201

**CMIMI**  
**6.500 Lek**



## NGJESHES TOKE

- | Gjeresia e punes: 57 cm
- | Volumi i rrollit: 46 L
- | Pesha bosh: 10.5 kg

Kodi : 34.153.02

**CMIMI**  
**9.500 Lek**



## KORRESE BARI MANUALE

- | 28.1 HM Easy
- | Per lendina deri ne 250 m<sup>2</sup>
- | Gjeresia e prerjes 28 cm
- | Lartesia e prerjes : 14 - 35 mm
- | Rrotat 128 mm

Kodi 113864

**CMIMI**  
**9.900 Lek**





## KORRESE BARI ME BENZINE

- | Rezultatet optimale te korrjes dhe kapjes fale formes aerodinamike te karkases
- | Doreza e përparme per transport komod
- | Karkase celiku me cilesi te larte
- | Motor OHV per ndezje te shpejte
- | Rregullim i lartesisë qendrore te prerjes



**HONDA**

### KORRESE BARI ME BENZINE



- | 5231 SP-H
- | Gjeresi prerje 51 cm
- | 3.2 kW HONDA GCVx 170
- | Per lendina deri ne 1.800 m<sup>2</sup>
- | Koshi 71 L
- | Me rrota aktive
- | Shkarkimi anesor i integruar

Kodi 127605



**CMIMI**  
**99.000 Lek**

### KORRESE BARI ME BENZINE

**AL-KO**

- | PREMIUM 520 VS-B
- | Gjeresi prerje 51 cm
- | 2.6 kW B&S Series 675EXi
- | Per lendina deri ne 1.800 m<sup>2</sup>
- | Koshi 70 L
- | Me rrota aktive
- | Shkarkimi anesor i integruar

Kodi 119949



**CMIMI**  
**79.000 Lek**



- 1
- 2
- 3
- 4
- 5
- 6
- 7
- 8
- 9
- 10

**KORRESE BARI  
ME BENZINE**

- | Motori 196 cc
- | Gjeresi prerje 56 cm
- | 6 pozicione prerje 25-75 mm
- | Koshi 65 L
- | 4 ne 1 funksione
- | Me shpejtesi te ndryshueshme
- | Me rrota aktive

**Kodi PM5860**

**CMIMI  
49.900 Lek**

NAKAYAMA



PRO

**KORRESE BARI  
ME BENZINE**

- | Motori 196 cc
- | Gjeresi prerje 53 cm
- | 6 pozicione prerje 25-75 mm
- | Koshi 65 L
- | Me shpejtesi te ndryshueshme
- | Me rrota aktive

**Kodi PM5810**

**CMIMI  
45.900 Lek**

NAKAYAMA



**KORRESE BARI  
ME BENZINE**

- | Motori 170 cc
- | Gjeresi prerje 51 cm
- | 6 pozicione prerje 25-75 mm
- | Me shpejtesi te ndryshueshme
- | Koshi 65 L

**Kodi PM5310**

**CMIMI  
39.900 Lek**

NAKAYAMA





# KORRESE BARI ME BENZINE

## KORRESE BARI ME BENZINE

AL-KO

- | Easy 5.10 SP-S
- | Gjeresi prerje 51 cm
- | Per lendina deri ne 1.800 m<sup>2</sup>
- | Koshi 60 L
- | Me rrota aktive
- | Shkarkimi anesor i integruar

4 IN ONE function

Kodi 113796



CMIMI  
45.900 Lek

EASY



## KORRESE BARI ME BENZINE

AL-KO

- | Easy 4.60 SP-S
- | Gjeresi prerje 46 cm
- | Per lendina deri ne 1.400m<sup>2</sup>
- | Koshi 60 L
- | Lartesia e prerjes : 30 - 75 mm
- | Me rrota aktive

Kodi 113795



CMIMI  
36.900 Lek

EASY



## KORRESE BARI ME BENZINE

AL-KO

- | Easy 4.2 P-S
- | Gjeresi prerje 42 cm
- | Per lendina deri ne 800 m<sup>2</sup>
- | Koshi 50 L
- | Lartesia e prerjes : 30 - 75 mm

Kodi 113794

CMIMI  
29.900 Lek

EASY



## KORRESE BARI ME BENZINE

Einhell

- | Motori 170 cm<sup>3</sup>
- | Fuqia 2.7 kW
- | Gjeresi prerje 51 cm
- | Koshi 70 L



NDEZJE  
ELEKTRIKE  
Kodi 34.048.70

CMIMI  
36.900 Lek



1

2

3

4

5

6

7

8

9

10



**KORRESE BARI**

LAUNTOP

- | Gjeresi prerje : 50 cm
- | Me 7 nivele prerje
- | Koshi : 70 L
- | Fuqia : 175 cc
- | Me rrota aktive



Kodi : LV50Z4

**CMIMI**  
**29.900 Lek**



**KORRESE BARI**

LAUNTOP

- | Gjeresi prerje : 46 cm
- | Lartesia e prerjes : 25 - 75 mm
- | Me 6 nivele prerje
- | Fuqia : 150 cc
- | Koshi 70 Lt



Kodi : LV46Z52

**CMIMI**  
**26.900 Lek**



**KORRESE BARI**

LAUNTOP

- | Gjeresi prerje : 41 cm
- | Koshi : 55 L
- | Lartesia e prerjes : 25 - 75 mm
- | Me 6 nivele prerje
- | Fuqia : 150 cc
- | 4-Kohë OHV EURO 5

Kodi : LV43T1

**CMIMI**  
**19.900 Lek**



**KORRESE BARI**

FORCE  
MACHINERY TOOLS

- | Gjeresi prerje 51 cm
- | Koshi : 60 L
- | Fuqia : 196cc
- | Me rrota aktive



Kodi : WX-SM5104B

**CMIMI**  
**27.900 Lek**

*3 në 1 - Prerje, bluarje,  
mbledhje, shkarkim anësor*



### KORRESE BARI



- | Gjeresi prerje 51 cm
  - | Me 7 nivele prerje
  - | Koshi : 65 L
  - | Fuqja : 196cc
  - | Me rrota aktive
- Kodi : GLM196200



**CMIMI**  
**28.900 Lek**



### KORRESE BARI



- | Gjeresi prerje 51 cm
  - | Me 7 nivele prerje
  - | Koshi : 60 L
  - | Fuqja : 196cc
  - | Me rrota aktive
- Kodi : GLM196201



**CMIMI**  
**27.900 Lek**



### KORRESE BARI



- | Gjeresi prerje 51 cm
  - | Me 5 nivele prerje
  - | Koshi : 65 L
  - | Fuqja : 171cc
- Kodi : GLM171200



**3.0kW/171cc**

510mm(20")

**CMIMI**  
**25.900 Lek**



Self-propelled



### KORRESE BARI



- | Gjeresi prerje : 46 cm
  - | Me 7 nivele prerje
  - | Koshi : 55 L
  - | Fuqja : 141cc
- Kodi GLM141180

**CMIMI**  
**19.900 Lek**





## TRAKTOR SOLO



- | Model T15-93.7 HD-A
- | Traktor kompakt
- | Gjeresi prerje 93 cm
- | Motor i fuqishem 7.7 kW
- | Koshi 220 Lt
- | Per lendina deri ne 6.000 m<sup>2</sup>

Kodi 127417

**CMIMI**  
**429.000 Lek**



## TRAKTOR SOLO



- | Model T18-105.4 HD V2
- | Gjeresia e prerjes 105 cm
- | Motor i fuqishem 9.1 Kw
- | Koshi 310 Lt
- | Perdorim i lehte
- | Per lendina deri ne 8.000 m<sup>2</sup>

Kodi 127707

**CMIMI**  
**590.000 Lek**





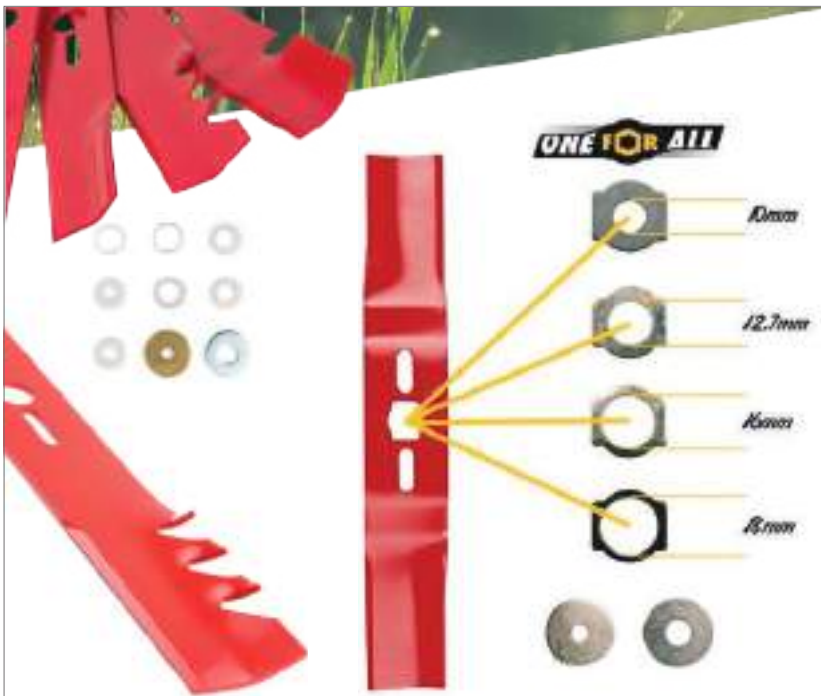

Thikat universale ONE FOR ALL përshtaten me të gjitha llojet e korrëseve të barit me benzinë, MTD, Alpina, Stiga, Stihl, Husqvarna, Einhell, Force.

Thika universale per korrëse bari

Kodi	Madhesia	Çmimi
69-248-0	40 cm	<b>2.200</b>
69-249-0	42 cm	<b>2.290</b>
69-258-0	45 cm	<b>2.390</b>
69-259-0	48 cm	<b>2.490</b>
69-260-0	50 cm	<b>2.590</b>
69-261-0	52 cm	<b>2.690</b>



4080-20



Çmimi  
**2.990**

4081-20



Çmimi  
**2.990**

4016-20



Çmimi  
**3.290**

4017-20



Çmimi  
**3.590**

Thike rezerve per korrëse

Gjatesia 32 cm

Thike rezerve per korrëse

Gjatesia 36 cm

Thike rezerve per korrëse

Gjatesia 37 cm

Thike rezerve per korrëse

Gjatesia 42 cm



440125



Çmimi  
**4.690**

474260



Çmimi  
**2.900**

474544



Çmimi  
**3.500**

492242



Çmimi  
**2.990**

Thike rezerve per korrëse

Classic 4.66 SP-A, 46 cm

Thike rezerve per korrëse

Classic 3.22 SE, 32 cm

Thike rezerve per korrëse

Classic 3.82 SE, 38 cm

Thike rezerve per korrëse

Easy 4.2 P-S, 42 cm

492208



Çmimi  
**3.950**

492209



Çmimi  
**3.990**

461742

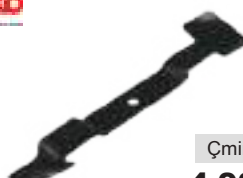

Çmimi  
**4.900**

461742



Çmimi  
**4.900**

Thike rezerve per korrëse

Easy 4.6 SP-S, 46 cm

Thike rezerve per korrëse

Easy 5.10 SP-S, 51cm

Thike per traktor

Majtas

Thike per traktor

Djahtas

LM321-SP-30 	LM383-SP-18 	LM385-SP-30 	LMLI2014-SP-22 
Çmimi <b>590</b>	Çmimi <b>990</b>	Çmimi <b>990</b>	Çmimi <b>1.150</b>
Thike rezerve per korrese LM321	Thike rezerve per korrese LM383	Thike rezerve per korrese Gjatesia 38 cm	Thike rezerve per korrese Gjatesia 34 cm
GLM141181-SP-B3 	GLM196201-SP-B3 	LM383-SP-22 	34.070.00 
Çmimi <b>1.390</b>	Çmimi <b>1.590</b>	Çmimi <b>1.990</b>	Çmimi <b>1.890</b>
Thike rezerve per korrese GLM14118, 46 cm	Thike rezerve per korrese GLM196201, 51 cm	Kosh rezerve per korresen LM383	Pompe Mekanike Benzin&vaj Per korrese me depozite 1.6Lt
Set rrotash 6" dhe 8" 	Set rrotash per LM385 	GLM196201-SP-B15 	LM383-SP-7 
		Çmimi <b>1.590</b>	Çmimi <b>190</b>
Kodi GLM141181-SP-B12 GLM141181-SP-B29	Çmimi 990 1.250	Kodi LM385-SP-34 prapa LM385-SP-36 perpara	Çmimi 690 590
577616401 	577616821 	577616435 	Zgjatues kabulli IP44 Me prize spine dhe kapak 
Çmimi <b>450</b>	Çmimi <b>450</b>	Çmimi <b>450</b>	
Vaj SAE30 me 4 kohe 0.6 L	Shiringe per depozite Vaj	Stabilizator karburanti 200ml 2T/4T	Kodi 5970010 5970020 5970030 5970035
			Pershkrimi 10 m 20 m 30 m 35 m
			Çmimi <b>1.490</b> <b>2.390</b> <b>2.790</b> <b>2.990</b>





**MOTOKOSA DHE  
ELEKTROKOSA**



**Einhell**

### MOTOKOSE ME BATERI

- | Motokose me bateri AGILLO 18/200
- | Nr rrotullimeve: 7.500 min-1
- | Gjeresia prerjes (Disk): 20 cm
- | Gjeresia prerjes (fije): 30 cm
- | Sistemi Spindle-Lock-System per te ndryshuar lehtesisht nga fije ne disk
- | Vetem trup

Kodi 34.113.10

**CMIMI  
11.900 Lek**

**POWER X-CHANGE**



**BOSHT I NDASHEM**



**Einhell**

### STARTER KIT

- | Set me bateri 18 V / 4.0 + karikues

Kodi 45.120.42

**CMIMI  
7.500 Lek**

**INGCC**  
Professional Tools Made in Germany

### MOTOKOSE ME BATERI 40 V

- | Nr rrotullimeve 75000 / min
- | Gjatesia prerjes 330 mm
- | Me 2 bateri 20 V / 4.0 Ah
- | Pajisur me koke me fije dhe top me fije dhe disk
- | Pa karboncina

Kodi CSTLI202522

**CMIMI  
21.900Lek**

**P20S BL MOTOR**



**INGCC**  
Professional Tools Made in Germany

### MOTOKOSE ME BATERI 40 V

- | Nr rrotullimeve 75000 / min
- | Gjatesia prerjes 330 mm
- | Pa karboncina
- | Pajisur me koke me fije dhe top me fije dhe disk
- | Vetem trup

Kodi CSTLI20018

**CMIMI  
14.500 Lek**

**P20S BL MOTOR**



1  
2  
3  
4  
5  
6  
7  
8  
9  
10



**MOTOKOSE  
ME BENZINE**

- | BC 500 B
- | Motor me 2-kohe
- | Fuqia 50 cc / 1.9 kW
- | Gjeresia prerjes 41 cm fije / 25 cm teh
- | Koka e fijes automatike
- | E perfshire mbajtes rripi

**Kodi 113785**

**CMIMI  
26.900 Lek**



**MADE IN  
GERMANY**



**MOTOKOSE  
ME BENZINE**

- | BC 400 B
- | Motor me 2-kohe
- | Fuqia 39.8 cc / 1.25 kW
- | Gjeresia prerjes 41 cm fije / 25 cm teh
- | Koka e fijes automatike
- | E perfshire mbajtes rripi

**Kodi 113784**

**CMIMI  
24.900 Lek**



**MADE IN  
GERMANY**



**MOTOKOSE  
ME BENZINE**

- | BC 330 B
- | Motor me 2-kohe
- | Fuqia 32.6 cc / 0.9 kW
- | Gjeresia prerjes 41 cm fije / 25 cm teh
- | Koka e fijes automatike
- | E perfshire mbajtes rripi

**Kodi 113758**

**CMIMI  
22.900 Lek**



**MADE IN  
GERMANY**



**MOTOKOSE  
ME BENZINE**

- | BC 223 B
- | Motor me 2-kohe
- | Fuqia 22.5 cc / 0.7 kW
- | Gjeresia prerjes 41 cm fije / 25 cm teh
- | Koka e fijes automatike
- | E perfshire mbajtes rripi

**Kodi 113692**

**CMIMI  
19.900 Lek**

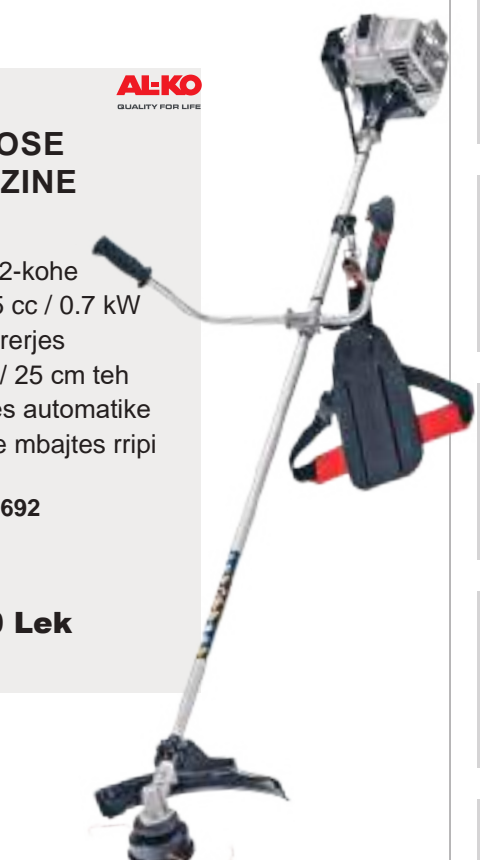

**MADE IN  
GERMANY**



### MOTOKOSE ME BENZINE

- | Fuqia 62 cc / 3.0 Hp
- | Aksi nje pjesesh 28 mm me sistem antidridhje
- | Timoni ergonomik forma U
- | Depozita karburantit 900 ml
- | Perfshin koken gjysme automatike dhe disk

Kodi PB6310

CMIMI  
**22.500 Lek**

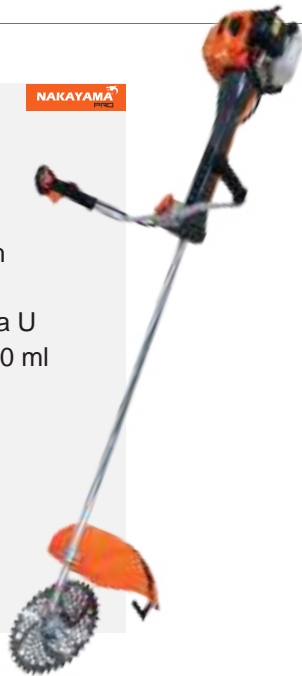

### MOTOKOSE ME BENZINE

- | Fuqia 62 cc / 3.0 Hp
- | Timoni ergonomik U
- | Depozita karburantit 900 ml
- | Perfshin koken gjysme automatike, diskun 3 T

Kodi PB6210

CMIMI  
**16.900 Lek**



### MOTOKOSE ME BENZINE

- | Fuqia 52 cc
- | Timoni ergonomik forma U
- | Depozita karburantit 900 ml
- | Perfshin koken gjysme automatike, diskun 3 T.
- | Koka e fijos automatike

Kodi PB5221

CMIMI  
**14.500 Lek**



### MOTOKOSE ME BENZINE

- | Motori 51.7 cc
- | Fuqia 2.3Hp
- | Sistem Antivibrimi
- | Timoni ergonomik forma U
- | Perfshin koken gjysme automatike dhe disk

Kodi PB5600

CMIMI  
**22.500 Lek**



**ERE**

### MOTOKOSE ME BENZINE

- | Model B33-B
- | Motori 33 cc
- | Fuqia 0.9 kW
- | Disk me fije dhe koke
- | Gjeresi prerje 42 cm

Kodi 967057401

CMIMI  
**13.900 Lek**

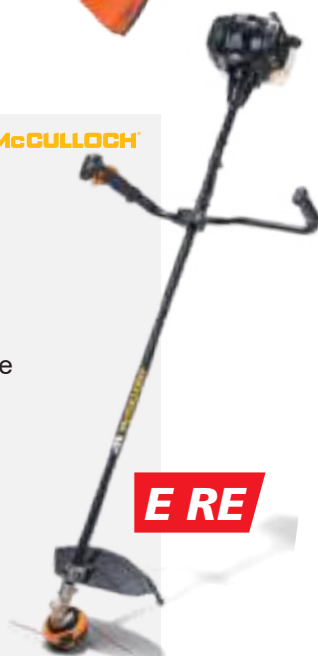

**ERE**

### MOTOKOSE ME BENZINE

- | Model B43BT
- | Motori 43 cc
- | Fuqia 1.25 kW
- | Disk me fije dhe koke
- | Gjeresi prerje 52 cm

Kodi 967683401

CMIMI  
**14.900 Lek**

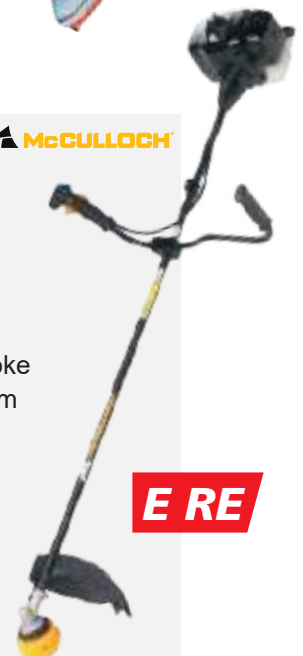

**ERE**



**PROLINE**

**MOTOKOSE  
ME BENZINE**

- | Motori 51.7 cc
- | Motori 1E44F
- | Fuqia 1.4 kW
- | Pajisur me disk
- | Koke me dopio fije 2.7 mm

Kodi CGTB52

CMIMI  
**13.500 Lek**



**PROLINE**

**MOTOKOSE  
ME BENZINE**

- | Motori 42.7 cc
- | Motori 1E40F
- | Fuqia 1.25 kW
- | Pajisur me disk
- | Koke me dopio fije 2.4 mm

Kodi CGTB43

CMIMI  
**12.900 Lek**



**PROLINE**

**MOTOKOSE  
ME BENZINE**

- | Motori 32.6 cc
- | Motori 1E36F
- | Fuqia 0.9 kW
- | Pajisur me disk
- | Koke me dopio fije 2.4 mm

Kodi CGTB33

CMIMI  
**12.500 Lek**



**PROLINE**

**MOTOKOSE  
ME BENZINE**

- | Motori 25.4 cc
- | Motori 1E34F
- | Fuqia 0.75 kW
- | Pajisur me disk
- | Koke me dopio fije 2.4 mm

Kodi CGTB26

CMIMI  
**12.200 Lek**



1  
2  
3  
4  
5  
6  
7  
8  
9  
10

**INGCO**  
Professional Tools Made Affordable

### MOTOKOSE ME BENZINE

- | Motori 62 cc
- | Shpejtesia max 9000 rpm
- | Gjeresia prerjes 480 mm
- | Pajisur me koke me fije dhe disk me 3 dhembe

Kodi GBC5624421

CMIMI  
**14.900 Lek**



Trup i ndashem



**INGCO**  
Professional Tools Made Affordable

### MOTOKOSE ME BENZINE

- | Motori 52 cc
- | Shpejtesia max 9000 rpm
- | Gjeresia prerjes 420 mm
- | Pajisur me koke me fije dhe disk me 3 dhembe

Kodi GBC5524421

CMIMI  
**14.500 Lek**

**52cc 1.4kW**



Trup i ndashem



**INGCO**  
Professional Tools Made Affordable

### MOTOKOSE ME BENZINE

- | Motori 42.7 cc
- | Shpejtesia max 9000 rpm
- | Gjeresia prerjes 420 mm
- | Pajisur me koke me fije dhe disk me 3 dhembe

Kodi GBC5434421

CMIMI  
**13.500 Lek**



Trup i ndashem



**INGCO**  
Professional Tools Made Affordable

### MOTOKOSE ME BENZINE

- | Motori me 4 kohe 31 cc
- | Shpejtesia max 9300 rpm
- | Gjeresia prerjes 480 mm
- | Pajisur me koke me fije dhe disk me 3 dhembe

Kodi GBC53144141

CMIMI  
**18.500 Lek**

**Motor me 4 kohe**



**MOTOKOSE  
ME BENZINE**

- | Fuqia 52 cc
- | Me disk
- | 40 Piston
- | Plastic Starter

Kodi WX-CG520A

CMIMI  
**9.900 Lek**

**ERE**



**MOTOKOSE  
MULTIFUNKSIONALE**

- | Model BS33-PS
- | Motori 33 cc
- | Fuqia 0.9 kW
- | Krasitese ligustrash
- | Sharre krasitese

Kodi 967865601

CMIMI  
**19.900 Lek**

**ERE**



**MOTOKOSE  
MULTIFUNKSIONALE**

- | Motori 32.6 cc
- | Motori 1E36F
- | Fuqia 0.9 kW
- | Shpate 25 cm
- | Zinxhir 3/8"

Kodi MT330

CMIMI  
**21.900 Lek**



**KRASITese  
MULIFUNKSIONALE**

- | Motori 25.4 cc
- | Motori me 2-kohe
- | Fuqia 0.7 kW
- | Krasitese ligustrash
- | Sharre krasitese

Kodi WX-CG300

CMIMI  
**14.900 Lek**





## ELEKTROKOSE ME BATERI

- | Ana me e bukur e kujdesit ndaj kopshteve
- | Doreza teleskopike e rregullueshme lejon të përshtatet me lartesine e trupit tuaj.
- | Tregues LED i baterise gjithmonë do ta dini se sa kohë mund të vazhdoni të punoni
- | Prerje e sakte, precize dhe e paster.



**GARDENA**

### ELEKTROKOSE ME BATERI

- | EasyCut 23/18V
- | Me 1 bateri 18 V / 2.0 Ah
- | Doreze teleskopike e rregullueshme

Kodi 14700-20

**ÇMIMI**  
**14.900 Lek**

**MADE IN GERMANY**



**ingco**  
Professional Tools Made Affordable

### ELEKTROKOSE ME BATERI

- | Tensioni 20 V
- | Nr rrotullimeve bosh 300 mm
- | Silencioze
- | Gjeresia e prerjes 300 mm
- | Fija (Twisted) 1.6 mm x 5 m

Kodi CGTLI20301

**ÇMIMI**  
**8.500 Lek**



**GARDENA**

### ELEKTROKOSE

- | SmallCut 550
- | Fuqia 550 W
- | Gjeresia e prerjes 28 cm
- | Koke me fije tap&go
- | Doreze teleskopike 90-120 mm

Kodi 9872-20

**ÇMIMI**  
**9.900 Lek**

**MADE IN GERMANY**



**GARDENA**

### ELEKTROKOSE

- | SmallCut 400
- | Fuqia 450 W
- | Gjeresia e prerjes 25 cm
- | Koke me fije tap&go 1.4 mm
- | Doreze teleskopike 90-120 mm

Kodi 9870-20

**ÇMIMI**  
**8.900 Lek**

**MADE IN GERMANY**



1  
2  
3  
4  
5  
6  
7  
8  
9  
10



## ELEKTROKOSE

- | SmallCut 300
- | Fuqia 300 W
- | Gjeresia e prerjes 23 cm
- | Koke me fije tap&go 1.4 mm

Kodi 9805-20

ÇMIMI  
**6.500 Lek**



## ELEKTROKOSE

- | GTE 450
- | Fuqia 450 W
- | Gjeresia e prerjes 30 cm
- | Koka e fijes automatike

Kodi 112929

ÇMIMI  
**9.990 Lek**



## ELEKTROKOSE

- | GTE 350
- | Fuqia 350 W
- | Gjeresia e prerjes 25 cm
- | Koka e fijes automatike

Kodi 112928

ÇMIMI  
**8.900 Lek**



## ELEKTROKOSE

- | GC-ET 4530 Set
- | Fuqia 450 W
- | Gjeresia e prerjes 30 cm
- | Koke me fije tap&go
- | Doreze teleskopike 90-120 mm

Kodi 34.020.22

ÇMIMI  
**7.500 Lek**

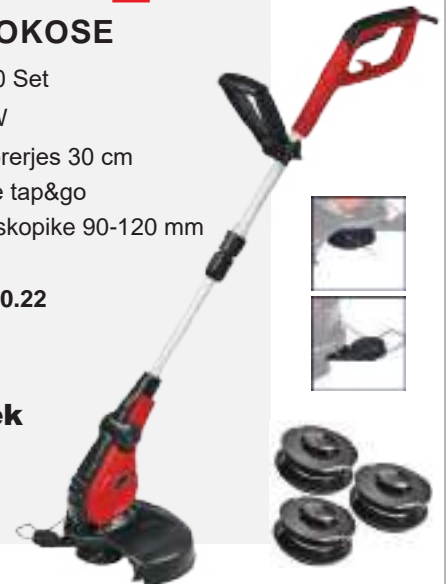

## ELEKTROKOSE

- | GT3512
- | Fuqia 350 W
- | Gjeresia e prerjes 25 cm
- | Bosht teleskopik 45-270 mm

Kodi GT3512

ÇMIMI  
**3.900 Lek**



## ELEKTROKOSE

- | WXM3502
- | Fuqia 350 W
- | Gjeresia e prerjes 25 cm
- | Koke me fije tap&go 1.2 mm
- | Doreze teleskopike 90-120 mm

Kodi WXM3502

ÇMIMI  
**2.900 Lek**





530183I



Çmimi  
**790**

Graso per motokosa

125 ml

577616407



**IRI**



Çmimi  
**150**

Vaj mishele 2T

100 ml

LB1000



Çmimi  
**330**

Vaj i kuq

100 ml

LB1050



Çmimi  
**1.650**

Vaj Mishelle i kuq

2T me dozim 1Lt

OIL-RED



Çmimi  
**850**

Vaj Mishele i kuq me dozim

2T, 1Lt

Fije elektokose GARDENA



Kodi	Gjatesia	Çmimi
5306-20	Per smallcut 300	<b>1.350</b>
5307-20	EasyCut 400, powercut 450	<b>1.350</b>

ALS1601



Çmimi  
**630**

Set me 2 Koka me fije per elektokosa

1.6 mm x 5 m

577616433



**IRI**



Çmimi  
**1.450**

Kit aksesoresh motokosash

Vaj 2T 100ml+syze+bidonperzjerje+fije

PB320



Çmimi  
**950**

Koke motokose

Universale

PB340



Çmimi  
**850**

Koke motokose me fije

Gjeresia e prerjes 35cm

PB300















Çmimi  
**890**

Koke alumini me 4 fije

35 cm



<p><b>N8</b></p>  <p>Çmimi <b>1.590</b></p>	<p>577615901</p>  <p>Çmimi <b>1.450</b></p>	<p>577615902</p>  <p>Çmimi <b>1.450</b></p>
<p><b>Kokë motokose</b></p>	<p><b>Kokë motokosash automatike</b></p>	<p><b>Kokë motokosash automatike</b></p>
<p>Me zinxhir</p>	<p>P25</p>	<p>P35</p>
<p><b>N7</b></p>  <p>Çmimi <b>650</b></p>	<p>PB310</p>  <p>Çmimi <b>1.250</b></p>	<p>ALS25405</p>  <p>Çmimi <b>1.090</b></p>
<p><b>Kokë alumini me 4 fije</b></p>	<p><b>Kokë automatike me 2 fije</b></p>	<p><b>Kokë me fije per motokose</b></p>
<p>Najloni</p>	<p>M10x1.25</p>	<p>Diametri 2.5 mm</p>
<p><b>N4</b></p>  <p>Çmimi <b>790</b></p>	<p><b>N2</b></p>  <p>Çmimi <b>650</b></p>	<p><b>N9</b></p>  <p>Çmimi <b>1.200</b></p>
<p><b>Kokë per fije najloni plastike</b></p>	<p><b>Kokë per fije najloni plastike</b></p>	<p><b>Kokë per fije najloni plastike</b></p>
<p>Me insert metalik</p>	<p>Plastike</p>	<p>Me perforcim metalik</p>
<p>89402</p>  <p>Çmimi <b>79</b></p>	<p>89422</p>  <p>Çmimi <b>99</b></p>	<p>Fije motokose profil yll</p> 
<p><b>Fije motokose profil te rumbullaket</b></p>	<p><b>Fije motokose profil yll</b></p>	<p><b>Kodi</b>      <b>Te dhena</b>      <b>Çmimi</b></p>
<p>1.6mm x 10m</p>	<p>1.6mm x 15m</p>	<p>89423      2.0 mm x 15m      <b>129</b></p>
		<p>89424      2.4 mm x 15m      <b>165</b></p>

1  
2  
3  
4  
5  
6  
7  
8  
9  
10

Fije motokosash TERRAMAX Blister

OREGON



Fije motokosash TERRAMAX Blister

OREGON



**ERE**

636775

OREGON



**ERE**

Çmimi  
**2.390**

Kodi	Te dhena	Çmimi
636779	2.7mm, 56m	<b>2.390</b>
636778	3.0mm, 44m	<b>2.390</b>

Kodi	Te dhena	Çmimi
636777	3.5mm, 36m	<b>2.390</b>
636776	4.0mm, 26m	<b>2.390</b>

Fije motokosash TERRAMAX Blister
4.5mm, 17m

Fije motokosash TERRAMAX Top

OREGON



**ERE**

Fije motokosash TERRAMAX Top

OREGON



**ERE**

636770

OREGON



**ERE**

Çmimi  
**8.900**

Kodi	Te dhena	Çmimi
636774	2.7mm, 280m	<b>8.900</b>
636773	3.0mm, 220m	<b>8.900</b>

Kodi	Te dhena	Çmimi
636772	3.5mm, 183m	<b>8.900</b>
636771	4.0mm, 128m	<b>8.900</b>

Fije motokosash TERRAMAX Top
4.5mm, 111m

Fije per motokosa me blister Round twist e zeze

SINT



**ERE**



Fije per motokosa me blister Round twist e zeze

SINT



**ERE**



Fije per motokosa me blister Round twist e zeze

SINT



**ERE**



Kodi	Te dhena	Çmimi
VTT3050	3.00 x 50m	<b>1.290</b>
VTT3537	3.50 x 37m	<b>1.290</b>

Kodi	Te dhena	Çmimi
VTT4028	4.00 x 28m	<b>1.290</b>
VTT4324	4.30 x 24m	<b>1.290</b>

Kodi	Te dhena	Çmimi
VTT4721	4.70 x 21m	<b>1.290</b>
VTT5019	5.00 x 19m	<b>1.290</b>
VTT5317	5.30 x 17m	<b>1.290</b>

Fije per motokosa ne karrukull me profil Twist Vortex

SINT



**ERE**



Fije per motokosa ne karrukull me profil Twist Vortex

SINT



**ERE**



Fije per motokosa me blister Round twist e zeze

NAKAYAMA



Kodi	Te dhena	Çmimi
VTT499	4.00 x 99m	<b>2.990</b>
VTT485	4.30 x 85m	<b>2.990</b>
VTT480	4.50 x 80m	<b>2.990</b>

Kodi	Te dhena	Çmimi
VTT477	4.70 x 77m	<b>2.990</b>
VTT570	5.00 x 70m	<b>2.990</b>
VTT564	5.30 x 64m	<b>2.990</b>

Kodi	Te dhena	Çmimi
NC1041	4.00mm-32m	<b>1.290</b>
NC1042	4.30mm-27m	<b>1.290</b>
NC1043	4.70mm-23m	<b>1.290</b>

NAKAYAMA PRO



Fije motokose me blister profil katror

Kodi	Trashesia	Cmimi
NC1013	3.0 x 48 m	<b>1.590</b>
NC1014	3.5 x 35 m	<b>1.590</b>
NC1015	4.0 x 24 m	<b>1.590</b>

NAKAYAMA PRO



Fije motokose me blister profil rrethor

Kodi	Trashesia	Cmimi
NC1008	3.0 x 56 m	<b>1.490</b>
NC1009	3.5 x 41 m	<b>1.490</b>
NC1010	4.0 x 32 m	<b>1.490</b>

NAKAYAMA PRO



Fije motokose me blister profil Twist

Kodi	Trashesia	Cmimi
NC1000	3.0 x 50 m	<b>1.490</b>
NC1001	3.5 x 36 m	<b>1.490</b>
NC1002	4.0 x 28 m	<b>1.490</b>
NC1003	4.3 x 23 m	<b>1.490</b>
NC1004	4.7 x 19 m	<b>1.490</b>

NAKAYAMA PRO



Fije motokose me karrukull profil katror

Kodi	Trashesia	Cmimi
NC1016	3.0 x 140 m	<b>4.590</b>
NC1017	3.5 x 103 m	<b>4.590</b>
NC1018	4.0 x 80 m	<b>4.590</b>

NAKAYAMA PRO



Fije motokose me karrukull profil Twist

Kodi	Trashesia	Cmimi
NC1005	4.0 x 80 m	<b>4.200</b>
NC1006	4.3 x 70 m	<b>4.200</b>
NC1007	4.3 x 113 m	<b>6.500</b>

NAKAYAMA PRO



Fije motokose me karrukull profil rrethor

Kodi	Trashesia	Cmimi
NC1011	3.0 x 168 m	<b>3.900</b>
NC1012	4.0 x 95 m	<b>3.900</b>

577616311

McGULLOCH



**IRI**

Çmimi  
**160**

577616313

McGULLOCH



**IRI**

Çmimi  
**190**

577616314

McGULLOCH



**IRI**

Çmimi  
**250**

Fije motokosash e rumbullaket

15m x 1.5mm



Fije motokosash e rumbullaket

15m x 2.0mm



Fije motokosash e rumbullaket

15m x 2.4mm



577616315

McGULLOCH



**IRI**

Çmimi  
**250**

ALS2001

INGCO



**ERE**

Çmimi  
**1.350**

577616831

McGULLOCH



**IRI**

Çmimi  
**290**

Fije motokosash e rumbullaket

10m x 3.0mm



Fije motokose rumbullake













2.0mm x 450gr













Litar starti i gatshem

3.5mm x 2.5m













1  
2  
3  
4  
5  
6  
7  
8  
9  
10



























295491-0 <b>OREGON</b>  Çmimi <b>990</b>	PB400 <b>NAKAYAMA</b>  Çmimi <b>850</b>	79563 <b>FLO</b>  Çmimi <b>650</b>
<b>Disk motokose me dy tehe</b> 255 x 25.4 mm	<b>Disk me 2 tehe</b> 300 x 25.4 mm	<b>Disk motokose me 2 tehe te kthyer</b> 320 mm / 25,4 mm
79560 <b>FLO</b>  Çmimi <b>390</b>	B1 <b>FORCE</b>  Çmimi <b>450</b>	B2 <b>FORCE</b>  Çmimi <b>390</b>
<b>Disk motokose i drejte me 2 tehe</b> 250 mm	<b>Disk motokose</b> Me 2 tehe 255 x 25mm	<b>Disk motokose</b> Me 2 tehe
295494-0 <b>OREGON</b>  Çmimi <b>1.900</b>	ABCB05 <b>incco</b>  Çmimi <b>790</b>	B3 <b>FORCE</b>  Çmimi <b>390</b>
<b>Disk motokose me tre tehe</b> 255 x 25.4 mm	<b>Disk preses motokose</b> Diametri 225 mm	<b>Disk motokose</b> Me 3 tehe 255 x 25mm
577614201 <b>McCULLOCH</b> <b>IRI</b>  Çmimi <b>790</b>	Disk motokose me 4 tehe <b>McCULLOCH</b> <b>IRI</b>  Kodi 577614205    Te dhena    Çmimi 577614202    Ø 230mm    790 577614202    Ø 255mm    950	79567 <b>FLO</b>  Çmimi <b>490</b>
<b>Disk motokose</b> 3 tehe Ø 255mm	<b>Disk motokose me 4 tehe</b> 250 mm / 25,4 mm	

<p><b>PB600</b></p>	<p><b>B12</b></p>	<p><b>79564</b></p>
<p><b>NAKAYAMA</b> PRO</p>  <p>Çmimi <b>950</b></p>	<p><b>FORCE</b></p>  <p>Çmimi <b>750</b></p>	<p><b>FLO</b></p>  <p>Çmimi <b>390</b></p>
<p>Disk motokose me 3 tehe 300 mm - 3 mm</p>	<p>Disk motokose me 3 tehe 300 x 25 mm</p>	<p>Disk motokose me 3 tehe 2 mm / 250 mm / 25,4 mm</p>
<p><b>79565</b></p>	<p><b>577614206</b></p>	<p><b>79562</b></p>
<p><b>FLO</b></p>  <p>Çmimi <b>450</b></p>	<p><b>MCCULLOCH</b></p> <p><b>IRI</b></p>  <p>Çmimi <b>790</b></p>	<p><b>FLO</b></p>  <p>Çmimi <b>550</b></p>
<p>Disk motokose me 3 tehe 2 mm / 250 mm / 25,4 mm</p>	<p>Disk motokose me shume dhembe Ø 230 mm</p>	<p>Disk motokose me 8 tehe 250 mm / 25,4 mm</p>
<p><b>PB250</b></p>	<p><b>PB700</b></p>	<p><b>TSB423045</b></p>
<p><b>NAKAYAMA</b> PRO</p>  <p>Çmimi <b>1.950</b></p>	<p><b>NAKAYAMA</b> PRO</p>  <p>Çmimi <b>950</b></p>	<p><b>INCCO</b></p>  <p>Çmimi <b>890</b></p>
<p>Mbrojtese disku per motokosa Me 10 dhembe</p>	<p>Disk motokose me 40 Dh 255 mm</p>	<p>Disk per motokose 230 mm x 40 Dh</p>
<p><b>B8</b></p>	<p><b>B9</b></p>	<p><b>B4</b></p>
<p><b>FORCE</b></p>  <p>Çmimi <b>790</b></p>	<p><b>FORCE</b></p>  <p>Çmimi <b>790</b></p>	<p><b>FORCE</b></p>  <p>Çmimi <b>850</b></p>
<p>Disk motokose me 36 dhembe 255 x 25 mm</p>	<p>Disk motokose me 36 dhembe 255 x 25 mm</p>	<p>Disk motokose 255 x 25 mm</p>









1  
2  
3  
4  
5  
6  
7  
8  
9  
10

<p><b>B10</b></p>  <p>Çmimi <b>750</b></p>	<p><b>79566</b></p>  <p>Çmimi <b>650</b></p>	<p><b>B5</b></p>  <p>Çmimi <b>690</b></p>
<p><b>Disk motokose</b> Me shume dhembe</p>	<p><b>Disk motokose me shume 40 dhembe</b> 250 / 25,4 mm</p>	<p><b>Disk motokose me shume dhembe</b> 255 x 25mm</p>
<p><b>E4</b></p>  <p>Çmimi <b>2.550</b></p>	<p><b>E4/26</b></p>  <p>Çmimi <b>2.550</b></p>	<p><b>P5 / CG420.7.1-1</b></p>  <p>Çmimi <b>890</b></p>
<p><b>Koke ingranazhi me aks 28mm</b> Per motokosa, 9 shlica</p>	<p><b>Koke ingranazhi me aks 26mm</b> Per motokosa Me 9 shlica</p>	<p><b>Mbrojtese disku</b> Per motokosa</p>
<p><b>Y4</b></p>  <p>Çmimi <b>550</b></p>	<p><b>577616826</b></p>  <p>Çmimi <b>990</b></p>	<p><b>PB100</b></p>  <p>Çmimi <b>2.990</b></p>
<p><b>Bidon benzine &amp; vaji</b> 2 L</p>	<p><b>Rrip mbajtës motokosash</b> Mbrojtese plastike</p>	<p><b>Rrip per mbajtje motokose</b> Me dopio veshje i plote</p>
<p><b>PB200</b></p>  <p>Çmimi <b>1.500</b></p>	<p><b>S7</b></p>  <p>Çmimi <b>2.250</b></p>	<p><b>S3</b></p>  <p>Çmimi <b>1.750</b></p>
<p><b>Rrip per mbajtje motokose</b> Me mbrojtese</p>	<p><b>Rrip per mbajtje motokose</b> Per motokosa</p>	<p><b>Rrip per mbajtje motokose</b> Per motokosa</p>



<p><b>PB900</b></p>   <p>Çmimi <b>990</b></p>	<p><b>PB970</b></p>   <p>Çmimi <b>1.590</b></p>	<p><b>HFSPC01</b></p>   <p>Çmimi <b>890</b></p>
<p><b>Kokore me rrjete mbrojtese</b> Me rrjete te imet</p>	<p><b>Helmete sharretari</b> Me kufje dhe rrjete mbrojtese</p>	<p><b>Kokore me xham mbrojtjes</b> Me mbrojtje plastike</p>
<p><b>HFSPC21</b></p>   <p>Çmimi <b>690</b></p>	<p><b>HFSPC32</b></p>   <p>Çmimi <b>690</b></p>	<p><b>74468</b></p>   <p>Çmimi <b>790</b></p>
<p><b>Kokore me rrjete mbrojtese</b> Me rrjete</p>	<p><b>Kokore</b> Me xham mbrojtjes</p>	<p><b>Kokore mbrojtese</b> Me rrjete</p>
<p><b>74471</b></p>   <p>Çmimi <b>990</b></p>	<p><b>74581</b></p>   <p>Çmimi <b>590</b></p>	<p><b>HEM01</b></p>   <p>Çmimi <b>650</b></p>
<p><b>Kokore</b> Me xham mbrojtjes</p>	<p><b>Kufje mbrojtese per veshet</b> Mbrojtje deri ne: 20.4 dB</p>	<p><b>Kufje mbrojtese per veshet</b> Mbrojtje deri ne: 24 dB</p>
<p><b>HEP02</b></p>   <p>Çmimi <b>50</b></p>	<p><b>HSG02</b></p>   <p>Çmimi <b>180</b></p>	<p><b>HSG05</b></p>   <p>Çmimi <b>270</b></p>
<p><b>Tampon veshesh</b> Per mbrojtje nga zhurma IHT</p>	<p><b>Syze mbrojtese</b> E bardhe e gomuar</p>	<p><b>Syze mbrojtese</b> E bardhe</p>

1  
2  
3  
4  
5  
6  
7  
8  
9  
10

WX-CG301	WX-CG302	WX-CG303
		
<b>ERE</b>	<b>ERE</b>	<b>ERE</b>
Çmimi <b>3.500</b>	Çmimi <b>2.900</b>	Çmimi <b>3.500</b>
<b>Koke krasitese ligustrash</b>	<b>Koke sharre krasitese</b>	<b>Koke fryrese gjethesh</b>
Per motokose multifunkionale WX-CG300	Per motokose multifunkionale WX-CG300	Per motokose multifunkionale WX-CG300
WX-CG304	K35	SHAKER
		
<b>ERE</b>		
Çmimi <b>3.500</b>	Çmimi <b>7.500</b>	Çmimi <b>12.500</b>
<b>Koke plugimi toke 26mm</b>	<b>Koke shkundes ulliri</b>	<b>Shkundes ulliri</b>
Per motokose multifunkionale WX-CG300	Per motokosa	Per motokosen MT330
K20	K25	PS2500EXT
		
<b>ERE</b>		
Çmimi <b>6.990</b>	Çmimi <b>1.900</b>	Çmimi <b>5.900</b>
<b>Koke plugimi 26mm</b>	<b>Aksesore motokose</b>	<b>Bisht zgjatues per motokose PS3100</b>
Per motokosa multifunkionale / standarte	Per korren e jonxhes	Gjatesia 100 cm

## Motokose me benzine 3 NE 1

Motori 26 cc | Fuqia 1 Hp | Gjeresi e prerjes 25 cm | Zinxhiri 3/8 LP 1.3 mm

PS3100

Çmimi  
**24.900**



NAKAYAMA  
PRO





**KRASITËSE LIGUSTRASH**

**FRYRËSE GJETHESH**

**MOTOSHARRA**



## KRASITESHË LIGUSTRASH ME BATERI

- | Falë peshës së ulët me krasiteset me bateri prerja e ligustrave është vërtet e lehtë.
- | Prerja të sakta, të pastra dhe të shpejta.
- | Ekrani LED i dukshëm i integruar në dorezë tregon nivelin aktual të ngarkimit të baterisë gjatë punës.
- | Me zero emisione gazrash dhe me zhurmë të ulët, krasitesët e ligustrave me bateri janë një zgjidhje e mirëpritur si për profesionistët ashtu edhe për kuruesit e peizazheve.



### KRASITESHË LIGUSTRASH ME BATERI

- | ARCURRA
- | Max shpejtesise 1400 rpm
- | Gjatesia e lames 55 cm
- | Prerja ne min 2400 min<sup>-1</sup>
- | Vetem trup

**STARTER KIT**  
Set me bateri  
18 V / 4.0 + karikues  
Art. 45.120.42  
CMIMI 7.500 Lek

Kodi 34.109.20

CMIMI  
**9.900 Lek**



### KRASITESHË LIGUSTRASH ME BATERI

- | Me 1 bateri 20 V / 2.0 Ah
- | Max shpejtesise 1400 rpm
- | Gjatesia e lames 45 cm

Kodi CHTLI20461

CMIMI  
**7.900 Lek**



### KRASITESHË LIGUSTRASH ME BATERI 40V

- | Me 2 bateri 20 V / 2.0 Ah
- | Motor pa karboncina
- | Gjatesia e lames 65 cm
- | Nr. rrotullimeve bosh 3600 rpm

Kodi CHTLI400282

CMIMI  
**19.900 Lek**



**P20S** **BL MOTOR**

650mm  
27mm

40V by 2x20V  
2.0Ah x2

Laser Cut Blade  
180°



### PRERESE BARI ME BATERI

- | Bateri e integruar Li-ION  
3.6 V / 2.5 AH
- | Autonomia 50 min

Kodi 9853-20

CMIMI  
6.900 Lek



### PRERESE BARI DHE LIGUSTRASH ME BATERI

- | Tensioni 20 V
- | Vetem trup
- | Gjeresia e prerjes per ligustra  
200 mm
- | Gjeresia e prerjes per bar 100 mm

Kodi CSTLI2001

CMIMI  
4.500 Lek



### KRASITESH LIGUSTRASH ELEKTRIKE

- | PowerCut 700/65
- | Fuqia 700 W
- | Gjatesia e lames 65 cm
- | Max. e prerjes 27 mm

Kodi 9835-20

CMIMI  
18.900 Lek



MADE IN GERMANY



### KRASITESH LIGUSTRASH ELEKTRIKE

- | EasyCut 500
- | Fuqia 500 W
- | Gjatesia e lames 55 cm
- | Max. e prerjes 18 mm

Kodi 9832-20

CMIMI  
12.900 Lek



MADE IN GERMANY



### KRASITESH LIGUSTRASH ELEKTRIKE

- | PowerCut 450
- | Fuqia 450 W
- | Gjatesia e lames 50 cm
- | Max. e prerjes 18 mm

Kodi 9831-34

CMIMI  
12.500 Lek



+



MADE IN GERMANY



### KRASITESH LIGUSTRASH ELEKTRIKE

- | PowerCut 450
- | Fuqia 450 W
- | Gjatesia e lames 50 cm
- | Max. e prerjes 18 mm

Kodi 09831-20

CMIMI  
11.900 Lek



MADE IN GERMANY



### KRASITESH LIGUSTRASH ELEKTRIKE

- | EasyCut 420/45
- | Fuqia 420 W
- | Gjatesia e lames 45 cm
- | Max. e prerjes 18 mm

Kodi 9830-20

CMIMI  
**11.500 Lek**



MADE IN GERMANY



### KRASITESH LIGUSTRASH ELEKTRIKE

- | GE-EH 6560
- | Fuqia 650 W
- | Gjatesia e lames 60 cm
- | Peshja 3.67 kg

Kodi 34.033.30

CMIMI  
**9.990 Lek**



### KRASITESH LIGUSTRASH ELEKTRIKE

- | GE-EH 4245
- | Fuqia 420 W
- | Gjatesia e lames 45 cm
- | Peshja 2.5 kg

Kodi 34.034.60

CMIMI  
**6.900 Lek**



### KRASITESH LIGUSTRASH ELEKTRIKE

- | Fuqia 710 W
- | Gjatesia e tehut 71 cm
- | Doreze rrotulluese 90°
- | Teh prerjes i dyfishte

Kodi EH7750

CMIMI  
**9.500 Lek**

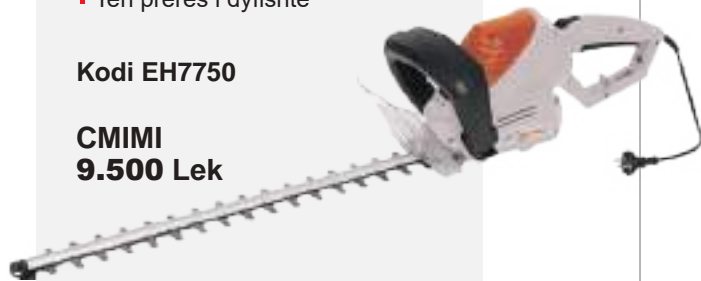

### KRASITESH LIGUSTRASH ELEKTRIKE

- | Fuqia 450 W
- | Gjatesia e tehut 50 cm
- | Nr rrotullimeve 3500 rpm
- | Teh me dhembe

Kodi EH4510

CMIMI  
**6.500 Lek**



### KRASITESH LIGUSTRASH ME BENZINE

- | Fuqia 1.0 Hp
- | Madhesia motorit 23 cc
- | Lama 60 cm
- | Doreze e rrotullueshme

Kodi PH2500

CMIMI  
**25.900 Lek**







**KRASITESH LIGUSTRASH ME BENZINE**

- | Fuqia 1.2 Hp
- | Madhesia motorit 25.4 cc
- | Lama 70 cm
- | Lame dyshe lasercut

Kodi PH2570

**CMIMI**  
**19.900 Lek**



**KRASITESH LIGUSTRASH ME BENZINE**

- | Model HT5622
- | Motori 22.7cc
- | Fuqia 0.65 kW
- | Motori me 2 kohe
- | Gjatesia tehut 56 cm

Kodi 967687801

**CMIMI**  
**14.900 Lek**



**KRASITESH LIGUSTRASH ME BENZINE**

- | Motori 25.4 cc
- | Fuqia 0.75 kW
- | Gjatesia tehut 55 cm

Kodi GHT5265511

**CMIMI**  
**14.500 Lek**

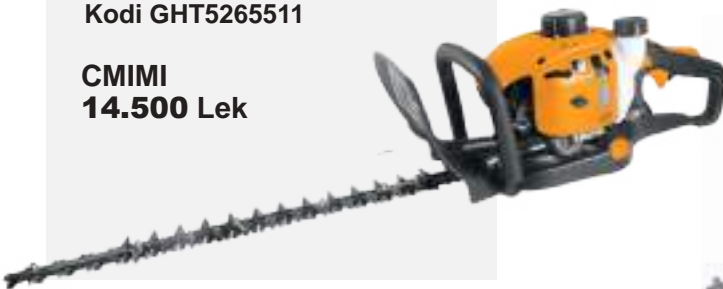

**KRASITESH LIGUSTRASH ME BENZINE**

- | Motori 1E34F-3
- | Madhesia motorit 25.4 cc
- | Fuqia 0.9 kW
- | Motori me 2 kohe
- | Gjatesia tehut 51 cm

Kodi SLP510

**CMIMI**  
**13.900 Lek**



**KRASITESH MULTIFUNKSIONALE**

- | Me 1 bateri 20 V / 2.0 Ah
- | Lama sharres 20 cm
- | Krasitese ligustrash 450 mm
- | Bisht teleskopik i zgjatueshem 60 cm

Kodi CPTS201681

**CMIMI**  
**18.500 Lek**



**KRASITESH DEGESH ME BATERI**

- | Me 1 bateri 18 V / 2.5 Ah
- | Gjatesia totale 2390 mm
- | Shpejtesia zinxhirit 3.8 m/s
- | Peshja 3.5 kg

Kodi 14770-20

**CMIMI**  
**27.500 Lek**



1  
2  
3  
4  
5  
6  
7  
8  
9  
10



### FRYRESE GJETHESH ME BATERI

- | GP-LB 36/210 Li E-Solo
- | Forca fryrese 816 m<sup>3</sup>/h
- | Shpejtesia e fryrjes 210 km/h
- | Pesha 2.45 kg
- | Vetem trup

Kodi 34.336.20

**CMIMI 12.900 Lek**

#### STARTER KIT

Set me bateri 18 V / 4.0 + karikues



Art. 45.120.42  
CMIMI 7.500 Lek



### FRYRESE GJETHESH ME BATERI

- | PT-C-EW-49 Li E-Solo
- | Momenti rrot: 15500 min
- | Shpejtesia e fryrjes 180 km/h
- | Pesha 1.22 kg
- | Vetem trup

Kodi 34.080.01

**CMIMI 4.900 Lek**

#### STARTER KIT

Set me bateri 18 V / 4.0 + karikues



Art. 45.120.42  
CMIMI 7.500 Lek



### FRYRESE DHE THITHESE GJETHESH ME BATERI

- | Tensioni 20 V
- | Shpejtesia 600-1100 rpm
- | Max fryrjes 10m<sup>3</sup>/min
- | Shpejtesia e fryrjes 190 km/h

Kodi CABLI2003

**CMIMI 9.500 Lek**



### FRYRESE GJETHESH ME BATERI

- | Tensioni 20 V
- | Shpejtesia 15000 rpm
- | Max fryrjes 8.5m<sup>3</sup>/min
- | Volumi ajrit 38m<sup>3</sup>/s
- | Vetem trup

Kodi CABLI20428

**CMIMI 7.500 Lek**



### FRYRESE GJETHESH ME BATERI

- | Me nje bateri 20 V / 2.0 Ah
- | Shpejtesia 15000 rpm
- | Max fryrjes 8.5m<sup>3</sup>/min
- | Shpejtesia e fryrjes 115 km/h

Kodi CABLI203235

**CMIMI 5.900 Lek**



### FRYRESE GJETHESH ME BATERI

- | Me nje bateri 20 V / 2.0 Ah
- | Shpejtesia 18000 rpm
- | Max fryrjes 2.7 m<sup>3</sup>/min

Kodi CABLI200181

**CMIMI 5.900 Lek**



**INGCO**  
Professional Tools Made Affordable

### FRYRESE GJETHESH ME BATERI

- | Tensioni 20 V
- | Max fryrjes 2.7 m<sup>3</sup>/min
- | Vetem trup

Kodi CABLI2001

**CMIMI**  
**4.500 Lek**



**INGCO**  
Professional Tools Made Affordable

### FRYRESE GJETHESH ME BATERI

- | Tensioni 20 V
- | Max fryrjes 2.7 m<sup>3</sup>/min
- | Vetem trup

Kodi CABLI20018

**CMIMI**  
**2.500 Lek**



**INGCO**  
Professional Tools Made Affordable

### FRYRESE GJETHESH ME BATERI

- | Tensioni 20 V
- | Max fryrjes 2.7 m<sup>3</sup>/min
- | Vetem trup

Kodi CABLI20028

**CMIMI**  
**1.900 Lek**



**INGCO**  
Professional Tools Made Affordable

### FRYRESE GJETHESH ELEKTRIKE

- | Fuqia 400 W
- | Shpejtesia 14000 rpm

Kodi AB4038

**CMIMI**  
**1.900 Lek**



**WAPPOW**

### FRYRESE GJETHESH ME BATERI

- | Tensioni 20 V
- | Max fryrjes 8.3 m<sup>3</sup>/min
- | Bateria 2.0 Ah

Kodi WBLP521

**CMIMI**  
**4.900 Lek**



**WAPPOW**

### FRYRESE GJETHESH ME BATERI

- | Tensioni 20 V
- | Max fryrjes 2.5 m<sup>3</sup>/min
- | Bateria 1.5 Ah

Kodi WBLP511

**CMIMI**  
**3.900 Lek**



1  
2  
3  
4  
5  
6  
7  
8  
9  
10



**INGCO**  
Professional Tools Made in Albania

### FRYRESE GJETHESH ELEKTRIKE

- | Fuqia 800 W
- | Shpejtesia 15000 rpm

Kodi AB8008

CMIMI  
5.500 Lek



**INGCO**  
Professional Tools Made in Albania

### FRYRESE GJETHESH ELEKTRIKE

- | Fuqia 650 W
- | Me shpejtesi te rregullueshme

Kodi AB6038

CMIMI  
2.900 Lek



**Einhell**

### FRYRESE / THITHESE GJETHESH

- | Fuqia 3000 W
- | Volumi i qeses 40 Lt
- | Max fryrjes 650 m<sup>3</sup>/h
- | Shpejtesia e fryrjes 240 km/h

Kodi 34.333.70

CMIMI  
6.500 Lek



**FORCE**  
MULTI-USE TOOLS

### FRYRESE GJETHESH ASPIRATOR ME BENZINE

- | Motori 42.7 CC / 1E40F
- | Fuqia 1.25 kW
- | Depozita 0.5 Lt
- | Pesha 5.2 Kg

Kodi EBV260

CMIMI  
19.900 Lek



**FORCE**  
MULTI-USE TOOLS

### FRYRESE GJETHESH SHPINE ME BENZINE

- | Motori 32.6 CC / 1E36F
- | Fuqia 0.9 kW
- | Nr. rrotullimeve 7000 rpm
- | Pesha 10.5 Kg

Kodi EB975

CMIMI  
27.500 Lek



**FORCE**  
MULTI-USE TOOLS

### FRYRESE GJETHESH ME BENZINE

- | Motori 25.4 CC / me 2 kohe
- | Fuqia 0.75 kW
- | Depozita 0.5 Lt
- | Pesha 5.2 Kg

Kodi EB260

CMIMI  
14.900 Lek



### MOTOSHARRE ME BATERI

- | Tensioni 40V (20+20)
- | Shpata Oregon 40 cm
- | Motor pa karboncina
- | Shpejtesia e zinxhirit 14.5 m/s
- | Perfshire 2 bateri 4.0 Ah

Kodi CGSLI401682

CMIMI  
26.900 Lek



### MOTOSHARRE KRASITSE ME BATERI

- | Me 2 bateri 20 V / 4.0 Ah
- | Shpata 30 cm
- | Motor pa karboncina
- | Shpejtesia zinxhirit 3700-4500rpm

Kodi CGSLI201286

CMIMI  
18.500 Lek



### MOTOSHARRE KRASITSE ME BATERI

- | Tensioni 20 V
- | Shpata 30 cm
- | Motor pa karboncina
- | Shpejtesia zinxhirit 3700-4500rpm
- | Vetem trup

Kodi CGSLI20128

CMIMI  
14.900 Lek



### MOTOSHARRE KRASITSE ME BATERI

- | Me 1 bateri 20 V / 2.0 Ah
- | Shpate 20 cm
- | Shpejtesia e zinxhirit 7.5m/s
- | Motor pa karboncina
- | Ka te pershire nje graso 15 ml

Kodi CGSLI20851

CMIMI  
9.900 Lek



### MOTOSHARRE KRASITSE ME BATERI

- | Me 2 bateri 20 V / 2.0 Ah
- | Shpate 15 cm
- | Motor pa karboncina
- | Shpejtesia e zinxhirit 11m/s

Kodi CGSLI20682

CMIMI  
14.900 Lek



### SHARRE MINI ME BATERI

- | Me bateri 20 V / 2.0 Ah
- | Shpate 13 cm
- | Shpejtesia e zinxhirit 5.0m/s

Kodi CGSLI20581

CMIMI  
6.900 Lek



1  
2  
3  
4  
5  
6  
7  
8  
9  
10

**Einhell**

**MOTOSHARRE ME BATERI**

- | FORTEXXA 18/30
- | Tensioni 18 V
- | Shpate 30 cm
- | Motor pa karboncina
- | Pesha 4.03 Kg
- | Vetem trup

**Kodi 46.000.10**

**CMIMI 18.500 Lek**



**WAPOW**

**SHARRE MINI ME BATERI**

- | Me bateri 20 V / 1.5 Ah
- | Shpate 13 cm
- | Shpejtesia e zinxhirit 4.8m/s

**Kodi WCLP552**

**CMIMI 5.500 Lek**



**OREGON**

**ELEKTROSHARRE ME VETEMPREHJE 2400 W**

- | CS1500
- | Fuqia: 2400 Wat
- | Shpejtesia e zinxhirit: 14.7 m/second
- | Zinxhiri: PowerSharp® 3/8 file™ .050"
- | Mekanizem vetemprehje
- | Shpata: 45 cm (18")
- | Pesha: 5.7 kg (12.6 lb)
- | Sistem automatik i shtrengimit te zinxhirit
- | Pompe vaji automatike

**Kodi 604419 + 542656 CMIMI 19.900 Lek**



**OREGON**

**ELEKTROSHARRE 1800 W**

- | CS1200
- | Fuqia: 1800 Wat
- | Shpejtesia e zinxhirit: 14.7 m/second
- | Zinxhiri: PowerSharp® 3/8 file™ .050"
- | Mekanizem vetemprehje
- | Shpata: 40 cm (16")
- | Sistem automatik i shtrengimit te zinxhirit
- | Pompe vaji automatike

**Kodi 620370 + 91305L CMIMI 14.500 Lek**





**ELEKTROSHARRE**

- | EKI 2200/40
- | Fuqia: 2200 Wat
- | Motor horizontal
- | Shpata 40 cm
- | Zinxhiri 3/8" 1.1 / 91PX056E
- | Tensioni i zinxhirit me regjistrues
- | Lubrifikimi automatik i zinxhirit
- | Pesha 5.4 kg

Kodi 112809

**CMIMI**  
**19.900 Lek**



**ELEKTROSHARRE**

- | EKS 2000/35
- | Fuqia: 2000 Wat
- | Motor vertikal
- | Shpata 35 cm
- | Zinxhiri 3/8" 1.1 / 91PX052E
- | Tensioni i zinxhirit me celes
- | Lubrifikimi automatik i zinxhirit
- | Pesha 4.8 kg

Kodi 112807

**CMIMI**  
**17.900 Lek**



**ELEKTROSHARRE**

- | GC-EC 2040
- | Fuqia: 2000 W
- | Shpate 40 cm
- | Zinxhiri: mm
- | Shpejtësia e prerjes 15.5 m/s
- | Pesha: 4.95 kg

Kodi 45.012.30

**E RE**

**CMIMI**  
**12.500 Lek**



**ELEKTROSHARRE**

- | GC-EC 1935-RED
- | Fuqia: 1900 W
- | Shpate: 35 cm
- | Zinxhiri: 1.3 mm
- | Shpejtësia e prerjes 15.5 m/s
- | Pesha: 4.65 kg

Kodi 45.012.20

**E RE**

**CMIMI**  
**11.500 Lek**





- Teknologjia e re e motorit OxyPower - deri në 20% kursim të karburantit deri në 70% zvogëlim i tymrave ndotëse / fuqi prerëse më e lartë në krahasim me motorin konvencional dy-kohësh.
- Sistemi i pastrimit të ajrit në hyrje me centrifugë. Nevojë e ulët për mirëmbajtjen e filtrit të ajrit dhe reduktim i dëmtimeve të pjesëve të lëvizshme të motorit.
- Sistemi i ndezjes Soft Start - Zvogëlon fuqinë që duhet të aplikohet për të nisur motorin deri në 40%. Sistemi i amortizimit të dridhjeve - Zvogëlon lodhjen e operatorit gjatë punës.



## MOTOSHARRE ME BENZINE



Made in USA

- | CS50S
- | Motori: 50cc
- | Fuqia: 2.8HP
- | Shpata: 45 cm
- | Pesha: 5.9kg

Kodi 967300301

**ERE**

CMIMI  
24.900 Lek



## MOTOSHARRE ME BENZINE

- | CS380TL
- | Motori: 38cc
- | Fuqia: 1.4 Kw
- | Shpata: 40 cm
- | Pesha: 5.2kg

Kodi 967326303

**ERE**

CMIMI  
17.900 Lek



## MOTOSHARRE ME BENZINE

- | CS35
- | Motori: 35cc
- | Fuqia: 1.4 Kw
- | Shpata: 35 cm
- | Pesha: 4.6kg

Kodi 967624614

**ERE**

CMIMI  
15.900 Lek



## MOTOSHARRE ME BENZINE

- | Fuqia 2.6 HP Motori 50 cc
- | Shpata 50 cm
- | Zinxhiri .325", 1.5 mm (76Dh)
- | Treguese i nivelit te vajit
- | Rregullim anesore i zinxhirit
- | Pompe vaji automatike / e rregullueshme
- | Pesha 5 Kg

Kodi PC5600

**CMIMI  
19.900 Lek**



## MOTOSHARRE ME BENZINE

- | Fuqia 2.45 HP Motori 45 cc
- | Shpata 45 cm
- | Zinxhiri .325", 1.3 mm (72Dh)
- | Treguese i nivelit te vajit
- | Rregullim anesore i zinxhirit
- | Pompe vaji automatike / e rregullueshme
- | Pesha 4.6 Kg

Kodi PC4600

**CMIMI  
16.900 Lek**



## MOTOSHARRE ME BENZINE

- | Motori 62 cc
- | Shpata Oregon 60 cm
- | Zinxhiri .325", 1.3 mm (72Dh)
- | Treguese i nivelit te vajit
- | Rregullim anesore i zinxhirit
- | Pompe vaji automatike / e rregullueshme
- | Pesha 4.6 Kg

Kodi GCS5602411

**CMIMI  
19.500 Lek**



**OREGON  
CHAIN**

## MOTOSHARRE ME BENZINE

- | Motori 46 cc
- | Shpata 45 cm
- | Zinxhiri .325", 1.3 mm
- | Fuqia 1.8 kW
- | Motor i fuqishem me 2 kohe
- | Rezervuar karburanti 550 ml

Kodi GCS5451811

**CMIMI  
12.900 Lek**



1

2

3

4

5

6

7

8

9

10



**MOTOSHARRE KRASITSE ME BENZINE**



- | BKS 2625 T
- | Motori 25.4 ccm
- | Fuqia 0.9 kW / 1.2 Hp
- | Shpata 25 cm, zinxhiri 3/8" spec.
- | Lubrifikimi automatik i zinxhirit
- | Pesha 3.2 kg



Kodi 113355

**CMIMI**  
**24.500 Lek**



**MOTOSHARRE KRASITSE ME BENZINE**



- | Motor me 2 kohe 25.4 cc
- | Fuqia 1.1 HP
- | Shpata 25 cm Zinxhiri 3/8" LP (40 Dh) 1.3 mm Pesha 3 Kg
- | Rregullim anesor i zinxhirit
- Pompe vaji automatik / i rregullueshem

Kodi PC3100

**CMIMI**  
**14.500 Lek**



**MOTOSHARRE KRASITSE ME BENZINE**



- | Motori 25.4 cc
- | Shpata 25 cm
- | Fuqia 0,7 kW (1 HP)
- | Rezervuar karburanti 230 ml
- | Motor i fuqishem me 2 kohe

Kodi GCS5261011

**CMIMI**  
**12.900 Lek**



**GRIRËSE DEGËSH**



- | Fuqia: 2500 W
- | Max diametrit të degës 40 mm
- | Pesha: 24.85 kg

Kodi 34.306.20

**CMIMI**  
**29.900 Lek**

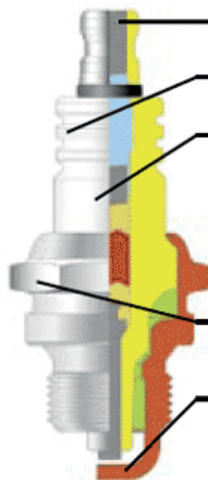

- Adaptori lidhës**  
Lidhje të qendrueshme dhe rezistence gjate dridhjeve
- Unaza ndarese**  
Per eliminimin e shkëndijave ne trup
- Unaze mbrojtëse**  
Permbajtje e larte e aliazhit te aluminit per te eliminuar mbinxehjen, shkëndijat elektrike dhe rezistence nga goditjet termike.
- Unaze izoluese**  
Mbron kandelen nga nxehtesia e tepert si dhe ofron lehtësi ne heqjen e kandeles.
- Fileto mashkull**  
Fale lidhjes te forte Nikel - Zink ofrohet nje rezistance e larte ndaj ndryshkut.
- Elektroda qendrore**  
Aliazhi i zinkut ofron nje rezistence te larte ndaj ndryshkut, nxehtesise te larte dhe qendrueshmeri me te larte



Kodi	Champion		Çmimi
77-306-1	OPR-17	Motosharra, motokosa	<b>350</b>
77-305-1	RJ19LM	Briggs&Stratton,Tecumseh	<b>350</b>
77-315-1	N9YC	Honda OHC, Robin EHV	<b>350</b>
77-355-1	TR15C	HQT3 Husqvarna, Stihl	<b>490</b>
77-321-1	I86C	Honda, Zenoah, Bertoloni	<b>350</b>
77-307-1	RCJ6Y	Motokosa Husqvarna,Stihl	<b>350</b>
77-324-1	RCJ7Y	Husqvarna, Stihl	<b>350</b>

# KANDELE UNIVERSALE

**E RE**

Kodi	Përshkrimi	Çmimi
<b>577616606</b>	Kandele RC12YC me qafe te gjate per korrese bari 16mm	<b>220</b>
<b>577616602</b>	Kandele RCJ7Y me qafe te shkurter per motora 2-kohe H19mm	<b>200</b>
<b>577616604</b>	Kandele RDJ7Y me qafe te shkurter per motora 2-kohe H16mm	<b>250</b>
<b>577616603</b>	Kandele RDJ8J me qafe te shkurter per motora 2-kohe H16mm	<b>250</b>
<b>577616601</b>	Kandele RJ19LM per korrese bari H21mm	<b>200</b>
<b>577616605</b>	Kandele RN9YC me qafe te gjate per motora me 4-kohe H21mm	<b>210</b>
<b>577616608</b>	Kandele champion per motora me 2-kohe H19mm	<b>210</b>
<b>577616610</b>	Kandele per motora 2T/4T H19mm	<b>160</b>
<b>577616612</b>	Kandele me qafe te gjate per motora 4-kohe	<b>160</b>
<b>577616607</b>	Kandele CMR7H per motora me 2-kohe H16mm	<b>250</b>



## ASORTMENTI I KANDELEVE

GAMA E KANDELEVE			- TABELA E REFERENCIVE -								SPECIFIKAT			
HUSQVARNA	MCULLOCH	OREGON	CHAMPION	NGK	BOSCH	BRISK	BRIGGS & STRATTON	HONDA	KAWASAKI	KOHLER	TORCH	MASA HEXAGON	PER	
577616600-01	577616602	77-324-1	RCJ7Y	BPMTA	WSR7E	PR17C					L7RTC	19mm	Motora me 2-kohe	
590701-01		77-307-1	RCJ5Y	BPMB8A	WSR5F	PR15YC					L8RTC	19mm	Motora me 2-kohe	
5908438-01		77-255-1	CMR8H	USR7AC	BR15C							16mm	Motora me 2-kohe	
590702-01			RY4C	CMR6A		SR15C					ACERA	16mm		
5908430-01			R7YC	CMR74	USR6AC	BR14C					CMRTH	16mm	Motora me 2-kohe	
5908441-01	577616601	77-305-1	RJ19LM	BR2LM	WR1E0	JR19	992302				BR2LM	22mm	Mot. 4-kohe Korrese bari	
5908442-01	577616605	77-316-1	RM9YC	BPMB6S	WR7DC	LR15YC					FR7TC	21mm		
5908443-01	577616607		CMR5H			BR17C						16mm	Motora me 2-kohe	
5908444-01	577616606		RC12YC	BPMB6S	FR5DC	DR17YC	99205 & 992304 8.692720				121302	K5RTC	16mm	Mot. 4-kohe 985 DIN/DOV
5908445-01	577616603		RDJ8J	BPMB6F		UR17					NERC	16mm	Motora me 2-kohe	
596420-01			RN19YC	BPMB6S	WR7DC	LR19YC						21mm	Mot. 4-kohe HONDA KAWASAKI	
	577616608	77-306-1	RCJ8	BPMB6A	WSR7E	PR17					L6RC	19mm	Motora me 2-kohe	
	577616610	77-270-1	RCJ5Y	BPMB6A	WSR5F	PR18Y					L8RTC	19mm	Mot. 4-kohe H1U/ Kawengines	
	577616604		RDJ7Y	BPMB6F		UR15					NERTC	16mm	Motora me 2-kohe	
	577616612		RC7YC		FR5DC	DR19YC					K7RTC.F	16mm	Mot. 4-kohe Korrese bari	

**Lima zinxhiri rrethore (12cope)**



Çmimi

**2.590**

Ø=	Ø=mm	L=″/mm	Kutia
9/64	3.6	8/200	LC10000-03-964
5/32	4.0	8/200	LC10000-03-532
11/644	4.5	8/200	LC10000-03-45
3/16	4.8	8/200	LC10000-03-316
13/64	5.2	8/200	LC10000-03-1364
7/32	5.5	8/200	LC10000-03-732

**Doreza druri Woody**

Per lima rrumbullake.



Çmimi

**150**

Kodi	L=mm	Lloji	
AL340	100	Ø 5/32" -> 5/16"	1

**Doreza Cobra**

Per lima petashuqe



Çmimi

**220**

Kodi	L=mm	Lloji	
AL250	90	/	12

12211

**Lima zinxhiri OREGON**

**Lima zinxhiri OREGON**



Çmimi

**5.900**

**Lima OREGON**

**Petashuqe**

Kodi	Te dhena	Çmimi	Kodi	Te dhena	Çmimi
105898	3.6mm	<b>250</b>	70503	4.8mm	<b>250</b>
70504	4.0mm	<b>250</b>	70505	5.2mm	<b>250</b>
70511	4.5mm	<b>250</b>	70502	5.5mm	<b>250</b>

577615701



**Set me 2 lima**



Çmimi

**990**

**Set me 2 lima 4.0mm**

**Lime te sheshte dhe doreze**

Kodi	Te dhena	Çmimi
577615703	4.5mm	<b>290</b>
577615704	4.8mm	<b>290</b>

577615705



Çmimi

**290**

**Set me 2 lima 4.0mm**

**Lime te sheshte dhe doreze**

**Set me 2 lima**

**5.5mm**

577615707



Çmimi

**290**



Çmimi

**290**



Çmimi

**290**

**Lime e sheshte**

6.0mm













**Lima (3 cope)**

4.0 mm

**Lima (3 cope)**

4.5 mm



577616420 <b>McCULLOCH</b> <b>IRI</b>  Çmimi <b>850</b>	577616519 <b>McCULLOCH</b> <b>IRI</b>  Çmimi <b>1.450</b>	91305L <b>OREGON</b>  Çmimi <b>1.490</b>
<b>Bidon benzine</b> 5 L	<b>Doreza sharrtari</b> Masa XL 10"	<b>Doreza lekure</b> Masa L
ES2310 <b>NAKAYAMA</b>  Çmimi <b>12.900</b>	ES9100 <b>NAKAYAMA</b>  Çmimi <b>850</b>	LB1150 <b>NAKAYAMA</b>  Çmimi <b>1.590</b>
<b>Mprehese zinxhri 230W</b> Disku $\Phi 145 \times 22.2 \times 3.2$ mm	<b>Gurë mprehës zinxhirash</b> Modeli i zinxhirit: $\Phi 145 \times 22.2 \times 3.2$ mm	<b>Vaj zinxhiri i biodegradueshem</b> 1 Lt
57-036 <b>OREGON</b>  Çmimi <b>320</b>	57-043 <b>OREGON</b>  Çmimi <b>320</b>	57-039 <b>OREGON</b>  Çmimi <b>490</b>
<b>Celesa kandelesh OREGON</b> 13x19x55	<b>Celesa kandelesh OREGON</b> 13x19x68	<b>Celesa kandelesh OREGON</b> 13x19x78
<b>Litar starteri</b> <b>OREGON</b>  <b>Made in Germany</b>	<b>Litar starteri</b> <b>OREGON</b>  <b>Made in Germany</b>	<b>Litar starteri</b> <b>OREGON</b>  <b>Made in Germany</b>
<b>Kodi</b> <b>Te dhena</b> <b>Çmimi</b>	<b>Kodi</b> <b>Te dhena</b> <b>Çmimi</b>	<b>Kodi</b> <b>Te dhena</b> <b>Çmimi</b>
90200      3.0mm <b>3.900</b>	90202      4.0mm <b>5.900</b>	90204      5.0mm <b>7.500</b>
90201      3.5mm <b>4.500</b>	90203      4.5mm <b>6.500</b>	90205      5.5mm <b>8.500</b>

1  
2  
3  
4  
5  
6  
7  
8  
9  
10

# OREGON Shpikësi i zinxhirit të motosharrave

Zinxhirët Oregon përshtaten me të gjitha markat prodhuese të motosharrave.

**KUJDES!**  
Vetëm zinxhirit Oregon kanë të stampuar mbi dhembe logon OREGON



	Kodi	Hapi	Profili	Kanali	Nr. i dhembeve	Çmimi /top
	90PX100R	3/8 LOW PRO		.043" 1.1 mm	820	<b>39.500</b>
	91P100R	3/8 LOW PRO		.050" 1.3 mm	820	<b>32.900</b>
	91VXL100R	3/8 LOW PRO		.050" 1.3 mm	820	<b>37.500</b>
	20LPX100R	0.325		.050" 1.3 mm	924	<b>47.500</b>
	21LPX100R	0.325		.058" 1.5 mm	924	<b>47.500</b>
	72LPX100R	3/8		.050" 1.3 mm	820	<b>47.500</b>
	73LPX100R	3/8		.058" 1.5 mm	820	<b>45.900</b>
	73EXL100R	3/8		.058" 1.5 mm	816	<b>44.500</b>
	75LPX100R	3/8		.063" 1.6 mm	820	<b>45.900</b>
	75EXL100R	3/8		.063" 1.6 mm	816	<b>37.500</b>

## Zinxhir i gatshem 3/8" 1.1mm - 3/8 1.3mm



Made in USA

Kodi	Hapi	Profili	Kanali	Nr. i dhembeve	Çmimi
90PX040E	3/8"	7	.043" 1.1 mm	20	<b>1.490</b>
90PX044E	3/8"	7	.043" 1.1 mm	22	<b>1.590</b>
90PX045E	3/8"	7	.043" 1.1 mm	22.5	<b>1.690</b>
90PX050E	3/8"	7	.043" 1.1 mm	25	<b>1.750</b>
90PX052E	3/8"	7	.043" 1.1 mm	26	<b>1.790</b>
90PX055E	3/8"	7	.043" 1.1 mm	27.5	<b>2.590</b>
90PX057E	3/8"	7	.043" 1.1 mm	28.5	<b>2.590</b>
90PX058E	3/8"	7	.043" 1.1 mm	29	<b>2.650</b>
91P032E	3/8"	7	.050" 1.3 mm	16	<b>990</b>
91P040E	3/8"	7	.050" 1.3 mm	20	<b>1.100</b>
91P044E	3/8"	7	.050" 1.3 mm	22	<b>1.150</b>
91P045E	3/8"	7	.050" 1.3 mm	22.5	<b>1.190</b>
91P046E	3/8"	7	.050" 1.3 mm	23	<b>1.290</b>
91P050E	3/8"	7	.050" 1.3 mm	25	<b>1.350</b>
91P052E	3/8"	7	.050" 1.3 mm	26	<b>1.390</b>
91P054E	3/8"	7	.050" 1.3 mm	27	<b>1.490</b>
91P055E	3/8"	7	.050" 1.3 mm	27.5	<b>1.550</b>
91P056E	3/8"	7	.050" 1.3 mm	28	<b>1.690</b>
91P057E	3/8"	7	.050" 1.3 mm	28.5	<b>1.690</b>
91P058E	3/8"	7	.050" 1.3 mm	29	<b>1.750</b>
91P060E	3/8"	7	.050" 1.3 mm	30	<b>1.790</b>
91P062E	3/8"	7	.050" 1.3 mm	31	<b>1.890</b>
91P064E	3/8"	7	.050" 1.3 mm	32	<b>1.990</b>
91P068E	3/8"	7	.050" 1.3 mm	34	<b>2.150</b>
91P072E	3/8"	7	.050" 1.3 mm	36	<b>2.250</b>



## Zinxhir i gatshem 0.325 1.3mm - 3/8" 1.5 mm - 3/8" 1.6 mm

	Kodi	Hapi	Profili	Kanali	Nr. i dhembeve	Çmimi
	20LPX050E	0.325		050" 1.3 mm	25	<b>2.200</b>
	20LPX060E	0.325		050" 1.3 mm	30	<b>2.390</b>
	20LPX064E	0.325		050" 1.3 mm	32	<b>2.500</b>
	20LPX066E	0.325		050" 1.3 mm	33	<b>2.790</b>
	20LPX068E	0.325		050" 1.3 mm	34	<b>2.850</b>
	20LPX072E	0.325		050" 1.3 mm	36	<b>2.850</b>
	20LPX074E	0.325		050" 1.3 mm	37	<b>2.990</b>
	20LPX076E	0.325		050" 1.3 mm	38	<b>3.150</b>
	73LPX060E	3/8"		.058" 1.5 mm	30	<b>2.390</b>
	73LPX064E	3/8"		.058" 1.5 mm	32	<b>2.200</b>
	73LPX066E	3/8"		.058" 1.5 mm	33	<b>2.500</b>
	73LPX068E	3/8"		.058" 1.5 mm	34	<b>2.500</b>
	73LPX072E	3/8"		.058" 1.5 mm	36	<b>2.690</b>

571039



Çmimi  
**4.900**

**ERE**



Set zinxhir + lame + yllez Kit Nano (1.1mm)

Zinxhir 3/8 1.3mm + Gur vetemprehes

Për motosharrën CS1500

Kodi	Te dhena	Çmimi
614379	25cm 0.325" per Stihl	<b>4.500</b>
637264	25cm 0.325" per HQ T525	<b>4.690</b>
614391	30cm 0.325" per HQ T435	<b>4.790</b>

Zinxhir i gatshem 24AP 1/4" (1.1mm)



**ERE**

Kodi	Te dhena	Çmimi
24AP028E	10cm 14dh	<b>2.800</b>
24AP056E	25cm 28dh	<b>2.900</b>



**ERE**

Kodi	Te dhena	Çmimi
24AP060E	25cm 30dh	<b>3.100</b>
24AP068E	30cm 34dh	<b>3.500</b>

▶ Oregon kompania me e madhe ne bote e prodhimit te zinxhirave, shpatave, aksesoreve te pylltarise si dhe makinerive per me shume se 70 vite. Oregon mban mbi supe prodhimin e zinxhirave dhe aksesoreve per brandet me te medha te prodhimit te motosharrave.



**PowerSharp®**  
Sistem i lehte per tu perdorur dhe duke ofruar precizion te larte ne prerje ne vetem pak sekonda. Shpatat te cilat pershtaten per sistemin kane te shenuar ne trup PowerSharp® ne menyre qe te pershtaten me vrimat perkatese.



**Lubri-Dam®**  
Sistemi Lubri-Dam eshte dizenuar ne menyre qe me cdo kalim te zinxhirit te arrije te transportoje vajin ne te gjithë rrugen e zinxhirit.



**LubriJet®**  
Sistemi LubriJet® arrin te drejtoje vajin nepermjet vrimes me kend ne xhepin e mbajtjes se vajit e me pas ne hallkat e zinxhirit duke ekspozuar zinxhirin ndaj vajit me 50 %.



**MICRO-LITE®**  
Sistemi MICRO-LITE® krijon nje ngushtim te shpates ne krahasim me shpatat standarte nepermjet te ciles rritet performanca e motosharres dhe reduktohet niveli i zhurmes.

- Game e plote e shpatave te motosharrave
- Te pershtatshme per amatore, profesioniste dhe gjysem profesioniste
- Teknologji e avancuar dhe cilesi e larte e garantuar nga OREGON

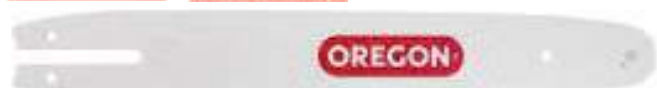

### SINGLE RIVET



### ADVANCECUT



### SPEEDCUT



### VERSACUT



### POWERCUT



### DURACUT

1

2

3

4

5

6

7



















8

9

10

















## SHPATA PER MOTOSHARRA STIHL



Kodi	Gjatesia	Kapja	Hapi	Kanali	Nr. i dhembeve	Çmimi
 120SDEA074	12" (30 cm)		3/8"	.050" 1.3 mm	44	<b>1.890</b>
 140SDEA074	14" (35 cm)		3/8"	.050" 1.3 mm	50	<b>2.100</b>
 160SDEA074	16" (40 cm)		3/8"	.050" 1.3 mm	55	<b>2.400</b>
 153SFGD025	15" (38 cm)		0.325"	.050" 1.3 mm	60	<b>2.500</b>
 163SFGD025	16" (40 cm)		0.325"	.063" 1.6 mm	67	<b>2.700</b>
 183SFGD025	18" (45 cm)		0.325"	.050" 1.3 mm	74	<b>2.500</b>
 183SFHD025	18" (45 cm)		3/8"	.063" 1.6 mm	66	<b>2.700</b>
 140SXEA074	20" (50 cm)		3/8"	.063" 1.3 mm	50	<b>2.690</b>
 203SFHD025	20" (50 cm)		3/8"	.063" 1.6 mm	72	<b>2.900</b>

## SHPATA PER MOTOSHARRA HUSQVARNA



Kodi	Gjatesia	Kapja	Hapi	Kanali	Nr. i dhembeve	Çmimi
 100SDEA041	10" (25 cm)		3/8"	.050" 1.3 mm	44	<b>1.490</b>
 124MLEA041	12" (30 cm)		3/8"	.043" 1.1 mm	45	<b>1.850</b>
 144MLEA041	14" (35 cm)		3/8"	.043" 1.1 mm	52	<b>2.190</b>
 144MLEA074	14" (35 cm)		3/8"	.043" 1.1 mm	52	<b>2.200</b>
 120SDEA041	12" (30 cm)		3/8"	.050" 1.3 mm	50	<b>1.900</b>
 140SDEA041	14" (35 cm)		3/8"	.050" 1.3 mm	52	<b>2.290</b>
 160SDEA041	16" (40 cm)		3/8"	.050" 1.3 mm	56	<b>2.390</b>
 140SDEA318	14" (35 cm)		3/8"	.050" 1.3 mm	50	<b>2.200</b>
160SDEA318	16" (40 cm)		3/8"	.050" 1.3 mm	54	<b>2.490</b>
180SDEA041	18" (45 cm)		3/8"	.050" 1.3 mm	62	<b>2.850</b>
160SXEA074	16" (40 cm)		3/8"	.050" 1.3 mm	55	<b>2.900</b>
180MLBK095	18" (45 cm)		0.325"	.050" 1.3 mm	72	<b>3.350</b>
188ATMD009	18" (45 cm)		3/8"	.058" 1.5 mm	68	<b>9.500</b>
150MLBK095	15" (38 cm)		0.325"	.050" 1.3 mm	64	<b>2.790</b>
160MLBK095	16" (40 cm)		0.325"	.050" 1.3 mm	67	<b>2.990</b>
188SFHD009	18" (45 cm)		0.325"	.050" 1.5 mm	68	<b>3.100</b>
203VXLHD025	20" (50 cm)		3/8"	.063" 1.6 mm	72	<b>4.700</b>





# SHPATA PER MOTOSHARRA

**IRI**

Kodi	Gjatesia	Hapi	Kanali	Nr. i dhembeve	Çmimi
 577614323	14" (35cm) (Stihl)	3/8"	1.3mm A318	25	<b>1.250</b>
 577614378	14" (35cm)	3/8"	1.3mm A095	26	<b>1.350</b>
 577614370	16" (40cm) (Stihl)	3/8"	1.3mm T318	27.5	<b>1.450</b>
 577614334	16" (40cm)	3/8"	1.3mm K095	28	<b>1.350</b>
 577614371	18" (45cm) (Stihl)	3/8"	1.3mm T318	30	<b>1.550</b>
 577614348	18" (45cm)	3/8"	1.3mm A041	31	<b>1.690</b>
 577614376	15" (38cm)	.325"	1.3mm K095	32	<b>2.450</b>
 577614355	18" (45cm) (Stihl)	.325"	1.3mm K095	36	<b>2.750</b>





## ZINXHIR I GATSHEM 3/8" MINI 1.1MM

Kodi	Gjatesia	Hapi	Kanali	Nr. i dhembeve	Çmimi
 577615101	12" (30cm)	3/8"	.043" 1.1mm	44	<b>1.350</b>
 577615103	12" (30cm)	3/8"	.043" 1.1mm	46	<b>1.390</b>
 577615105	14" (35cm)	3/8"	.043" 1.1mm	52	<b>1.450</b>

## ZINXHIR I GATSHEM 3/8" MINI 1.3MM

Kodi	Gjatesia	Hapi	Kanali	Nr. i dhembeve	Çmimi
 577615114	12" (30cm)	3/8"	.050" 1.3mm	44	<b>1.190</b>
 577615119	12" (30cm)	3/8"	.050" 1.3mm	49	<b>1.350</b>
 577615120	14" (35cm)	3/8"	.050" 1.3mm	49	<b>1.350</b>
 577615121	12" (30cm) (Stihl)	3/8"	.050" 1.3mm	50	<b>1.390</b>
 577615122	12" (30cm)	3/8"	.050" 1.3mm	52	<b>1.450</b>
 577615126	16" (40cm) (Stihl)	3/8"	.050" 1.3mm	55	<b>1.550</b>
 577615127	16" (40cm)	3/8"	.050" 1.3mm	56	<b>1.590</b>

## ZINXHIR I GATSHEM 0.325"

Kodi	Gjatesia	Hapi	Kanali	Nr. i dhembeve	Çmimi
 577615153	15" (38cm) (Stihl)	0.325"	.058" 1.5mm	64	<b>1.590</b>
 577615134	14" (38cm)	0.325"	.050" 1.3mm	64	<b>1.690</b>
 577615148	16" (40cm)	0.325"	.050" 1.3mm	66	<b>1.690</b>
 577615150	18" (45cm)	0.325"	.050" 1.3mm	72	<b>1.790</b>



## SHPATA PER MOTOSHARRA

**E RE**

Kodi	Gjatesia	Hapi	Kanali	Nr. i dhembeve	Çmimi
 YT-84916	(25cm)	3/8"	1.1mm	40	<b>790</b>
 YT-84917	(30cm)	3/8"	1.1mm	45	<b>850</b>
 YT-84925	(25cm)	3/8"	1.3mm	40	<b>790</b>
 YT-849299	(30cm) (Stihl)	3/8"	1.3mm	44	<b>790</b>
 YT-84930	(36cm) (Stihl)	3/8"	1.3mm	50	<b>950</b>
 YT-84931	(36cm)	3/8"	1.3mm	52	<b>950</b>
 YT-849301	(40cm) (Stihl)	3/8"	1.3mm	55	<b>990</b>
 YT-84935	(40cm)	3/8"	1.3mm	56	<b>990</b>
 YT-849331	(40cm)	0.325"	1.3mm	66	<b>990</b>
 YT-849332	(45cm)	0.325"	1.3mm	72	<b>1.100</b>
 YT-84933	(50cm)	0.325"	1.3mm	78	<b>1.150</b>



## ZINXHIR PER MOTOSHARRA

**I RI**

Kodi	Pershkrimi	Hapi	Kanali	Nr. i dhembeve	Çmimi
 YT-84959	Zinxhir top	3/8"	1.1mm	816	<b>14.500</b>
YT-84960	Zinxhir top	3/8"	1.3mm	816	<b>15.500</b>
YT-84963	Zinxhir top	0.325"	1.5mm	923	<b>19.500</b>
YT-84953	Zinxhir i gatshem	3/8"	1.3mm	54	<b>990</b>

AGSB51001

AGSB51202

**ingco**

**ingco**



Çmimi  
**1.190**



Çmimi  
**1.850**

Shpate motosharre

25 cm, per GCS5261011

Shpate motosharre

30 cm, per CGSLI2001, CGSLI20128, CGSLI201286

AGSB51801

AGSB52401

**ingco**

**ingco**



Çmimi  
**1.690**



Çmimi  
**2.990**

Shpate motosharre

45 cm, per GCS5451811

Shpate motosharre

60 cm, per GCS5602411

AGSB50501



**IRI**



Çmimi  
**790**

AGSB50801



**IRI**



Çmimi  
**990**

AGSB51603



**IRI**



Çmimi  
**1.490**

Shpate motosharre

12 cm, 1/4", 1.1 mm

Shpate motosharre

20 cm, 1/4", 1.1 mm

Shpate motosharre

40 cm, 3/8", 1.3 mm

## ZINXHIR PER MOTOSHARRA



**AGSC50501**

Zinxhir motosharre 1/4", 0.043", 32 DH, 12cm

**800 Leke**



**AGSC50801**

Zinxhir motosharre 3/8", 0.043", 33 DH, 20cm

**990 Leke**



**AGSC51001**

Zinxhir motosharre 25 cm, i pershtashem per GCS5261011

**1.250 Leke**



**AGSC51201**

Zinxhir motosharre, i pershtashem per CGSLI2001, CGSLI20128, CGSLI201286, UCGSLI201286

**1.450 Leke**



**AGSC51603**

Zinxhir motosharre 3/8", 0.043", 56 DH, 40cm

**1.550 Leke**



**AGSC51801**

Zinxhir motosharre 45 cm, i pershtashem per GCS5451811

**1.690 Leke**



**AGSC52401**

Zinxhir motosharre 60 cm per GCS5602411

**2.990 Leke**

24548B



Çmimi  
**14.900**

24549B



Çmimi  
**13.900**













Ç'perçinuese zinxhiri OREGON

Për keputjen e zinxhireve 3/8 .325, 3/8 pro, 404"025

Percinuese për perçinimin e zinxhireve

3/8, 325, 3/8 pro, 404"



<p>YT-84970</p> <p><b>YATO</b></p>  <p>Çmimi <b>5.900</b></p>	<p>YT-84971</p> <p><b>YATO</b></p>  <p>Çmimi <b>7.500</b></p>	<p>P23843</p> <p><b>OREGON</b></p>  <p>Çmimi <b>2.150</b></p>
<p><b>Percinuese Zinxhiri</b></p> <p>2.1mm 1/4 Metalike A3</p>	<p><b>Cpercinuese Zinxhiri</b></p> <p>1/4, 0.325, 3/8, 0.404, 90-91P</p>	<p><b>Percina</b></p> <p>.325 - 1.3 - 1.5 - 1.6 mm</p>
<p>P31939</p> <p><b>OREGON</b></p>  <p>Çmimi <b>2.900</b></p>	<p>P23910</p> <p><b>OREGON</b></p>  <p>Çmimi <b>2.900</b></p>	<p>P24295</p> <p><b>OREGON</b></p>  <p>Çmimi <b>2.150</b></p>
<p><b>Percina</b></p> <p>.325 - 1.3 - 1.5 mm</p>	<p><b>Percina</b></p> <p>3/8" - 1.3 - 1.5 mm</p>	<p><b>Percina</b></p> <p>3/8" - 1.3 mm mini</p>
<p>100962X</p> <p><b>OREGON</b></p>  <p>Çmimi <b>2.150</b></p>	<p>100791X</p> <p><b>OREGON</b></p>  <p>Çmimi <b>2.350</b></p>	<p>38145X</p> <p><b>OREGON</b></p>  <p>Çmimi <b>2.450</b></p>
<p><b>Kupe freksioni per motosharra</b></p> <p>Stihl 017, 018, 019, 021, 023</p>	<p><b>Kupe freksioni PRO 325-7Dh</b></p> <p>Stihl 024, 026, ms270, 260</p>	<p><b>Kupe freksioni PRO 3/8-7Dh</b></p> <p>Stihl 029, 034, ms290, ms310/360</p>
<p>21358X</p> <p><b>OREGON</b></p>  <p>Çmimi <b>2.450</b></p>	<p>108308X</p> <p><b>OREGON</b></p>  <p>Çmimi <b>2.590</b></p>	<p>29175X</p> <p><b>OREGON</b></p>  <p>Çmimi <b>2.800</b></p>
<p><b>Kupe freksioni 3/8", 7 dhëmbë</b></p> <p>për Dolmar CS-451, CS-452, CS-500</p>	<p><b>Kupe freksioni PRO 325-7Dh</b></p> <p>Husqvarna 340, 350, 357, 445</p>	<p><b>Kupe freksioni PRO 325-7Dh</b></p> <p>Husqvarna 50, 55</p>



Pasqyra rrethore

Ulese e rehatshme

## FREZA, TURRJELA DHE SPERKATËSE

**IRI**

Rrotat dhe thikat te perfshira

### MULTIKULTIVATOR/ TRAKTOR ME NAFTE

NAKAYAMA  
PRO

- | Motori 11 Hp
- | Ndezje elektrike
- | Gjeresia e punes 1050mm
- | 4 marshe 3+1
- | Goma 5x12 dhe 4x8
- | Set rrotash metalike dhe set thikash 16+16

Kodi MB9300

CMIMI

**350.000 LEK**



### PLUG TEK

- | Per Multikultivator/  
Traktor MB9300

Kodi MB9303

CMIMI

**19.900 LEK**



### PLUG DYSH

- | Per Multikultivator/  
Traktor MB9300

Kodi MB9304

CMIMI

**29.900 LEK**







**IRI**

## Funksioni i frezimit dhe punimit te toke



**2ne1**



### MULTIKULTIVATOR 2 NE 1 ME BENZINE

- | Motori 7 Hp/212cc (4 kohe)
- | 2 marsha, 1 para 1 pas
- | Thellesi 580mm
- | Me 12 thika

**NAKAYAMA**  
PRO

Kodi MB6510  
**CMIMI**  
**99.000 LEK**

### SET ME 2 RROTA METALIKE

- | Per Multikultivator 2 NE 1  
MB6510 (rezerve)

Kodi MB6511  
**CMIMI**  
**7.900 LEK**



### SET ME 12 THIKA

- | Per Multikultivator 2 NE 1  
MB6510 (rezerve)

Kodi MB6512  
**CMIMI**  
**5.900 LEK**





**E RE**

**NAKAYAMA**  
PRO

### FREZE TOKE ME NAFTE

- | Motor me 4 kohe
- | Motori 418 cc / 10 Hp
- | Gjeresia e punimit: 100 - 120 cm
- | Transmisioni 2 marshe perpara - 1 prapa
- | Ndezje elektrike me bateri dhe mbrojtese plastike + timon multifunksional

Kodi MB9005

CMIMI

**145.000 LEK**



Thika e djathte



Thika e majte

**NAKAYAMA**  
PRO

### FREZE TOKE ME NAFTE

- | Motori 418 cc / 10 Hp
- | Gjeresia e punimit: 110 cm
- | Ndezje elektrike me bateri
- | 3 marshe

Kodi MB9000CLASSIC

CMIMI

**125.000 LEK**



Thika e djathte



Thika e majte

1  
2  
3  
4  
5  
6  
7  
8  
9  
10

**NAKAYAMA**  
PRO

### FREZE TOKE ME BENZINE

- | Motori 7.5 Hp
- | 4 marshe 2+1
- | Gjeresia e punimit 100cm

Kodi MB7100

**CMIMI**  
**89.000 LEK**

**E RE**



Q  
V  
L

**NAKAYAMA**  
PRO

### FREZE TOKE ME BENZINE

- | Motori 196 cc / 6.5Hp
- | Gjeresia e punimit: 90-100 cm
- | Transmisioni 2 marshe perpara  
- 1 prapa
- | Rrota 5.00 x 12" Thika 16+16

Kodi MB7000CLASSIC

**CMIMI**  
**59.900 LEK**



Q  
V  
L

**NAKAYAMA**  
PRO

### KULTIVATOR ME BENZINE 2 NE 1

- | Motori 196 cc
- | Fuqia 6.5 Hp (4.5 kW)
- | Gjeresia e punimit: 85 mm
- | Goma 3.5-4

Kodi MB6000

**CMIMI**  
**57.500 LEK**



Q  
V  
L

1  
2  
3  
4  
5  
6  
7  
8  
9  
10

ORVIL



**E RE**

**NAKAYAMA**  
PRO

**FREZE TOKE  
ME BENZINE**

- | Motori 4.0 HP, 139cc
- | Gjeresia e punimit: 600 mm
- | 12+12 thika
- | 3 pozicione

Kodi MB5005

**CMIMI  
37.900 LEK**

**FORCE**  
EQUIPMENT - TOOLS

**KULTIVATOR  
ME BENZINE**

- | Motori 42.7cc
- | Gjeresia e punimit: 320 mm
- | Me 4 thika
- | Motor me 2 kohe

Kodi WG430

**CMIMI  
19.900 LEK**



ORVIL



**STARTER KIT**

Set me bateri  
18 V / 4.0 + karikues



Art. 45.120.42  
CMIMI 7.500 Lek

**Einhell**

**KULTIVATOR MINI  
ME BATERI**

- | Me bateri 18 V GE-CR 18/20
- | Gjeresia e punimit: 20 cm
- | Thellesia e punimit: 20 cm
- | Vetëm trup

Kodi 34.312.10

**CMIMI  
11.500 LEK**



**MOTOKULTIVATOR  
ME NAFTE**

- | Motor 178F
- | Fuqja: 6.5 HP
- | Gjeresia e punimit: 97 cm
- Thellesia e punimit: 15 cm
- Marshet: 2 + 2
- Rrota: 4-8

Kodi MF360D

**CMIMI  
115.000 LEK**

**FORCE**  
MACHINERY - TOOLS

**DIESEL**



**GRUP FREZE PER MOTOKULTIVATOR**

- | Gjeresia e punimit: 560 mm
- | Thellesia e punimit: 200 mm

Kodi TI360

**CMIMI  
39.900 LEK**



**GRUP KORRESE PER MOTOKULTIVATOR**

- | Gjeresia e prerjes: 970 mm
- | Lartesia e prerjes max: 20-60 mm

Kodi GC360B

**CMIMI  
46.900 LEK**



**RROTA METALIKE+HAPESE VIJASH**

- | Rrota: 420 mm
- | Hapese vijash per motokultivator MF360D

Kodi SP360

**CMIMI  
17.900 LEK**



**GRUP FREZE PER MOTOKULTIVATOR**

- | Gjeresia: 900 mm
- | Per motokultivator MF360D

Kodi SW360

**CMIMI  
74.900 LEK**



**MOTOKULTIVATOR  
ME NAFTE**

- | Motor 186F
- | Fuqja: 15 HP
- | Ndezje elektrike
- | Marshet: 3 + 3
- | Rrota: 5-10

Kodi MF380DE

CMIMI  
**165.000 LEK**

**FORCE**  
MACHINERY - TOOLS

**DIESEL**



**GRUP FREZE PER MOTOKULTIVATOR**

- | Gjeresia e punimit: 560 mm
- | Thellesia e punimit: 200 mm

Kodi TI400

CMIMI  
**45.900 LEK**



**GRUP KORRESE PER MOTOKULTIVATOR**

- | Gjeresia e prerjes: 1200 mm
- | Lartesia e prerjes max: 20-60 mm

Kodi GS400

CMIMI  
**49.900 LEK**



**SET ME 2 RROTA METALIKE**

- | 2 rrota metalike
- | Per motokultivator MF380DE

Kodi MW500

CMIMI  
**12.500 LEK**



1

2

3

4

5

6

7

8

9

10

SPS400



Çmimi  
**10.500**

SP400



Çmimi  
**14.500**

Plug toke

Per motokultivator MF380DE

Plug toke bashke me grup

Per motokultivator MF380DE

PL400



Çmimi  
**17.500**

SW400



Çmimi  
**79.900**

Plug toke bashke me grup te kompletuar

Per motokultivator MF380DE

Grup fshese pastrimi 1100 mm

Per motokultivator MF380DE

**NAKAYAMA**  
PRO

### TRAJLER BUJQESIE PER FREZA

- Per pesha deri ne 500 kg
- Goma 4.00X127, C-0.5Me 4 thika

Kodi MB211

**CMIMI**  
**45.000 LEK**



**McCULLOCH**

### TRAJLER BUJQESIE

- Per pesha deri ne 150 kg
- Goma 16"

Kodi 577616901

**CMIMI**  
**27.500 LEK**



**IRI**





### FREZE TOKE ME NAFTE

- | Motor i fuqishem
- | Fuqia 5.2 Hp
- | Marshet -1, 0, 2, 1
- | Gjeresia e punes 1200 mm
- | Thellesia e punes 150 -300 mm

Kodi DC12001

**CMIMI**  
**79.500 LEK**



### FREZE TOKE ME NAFTE

- | Fuqia 7.0 Hp (5.1 kW)
- | Me 2 marshe
- | Gjeresia e punes 1200 mm
- | Thellesia e punes 150 -300 mm

Kodi GC12001

**CMIMI**  
**59.500 LEK**



### KULTIVATOR ME BENZINE

- | Fuqia 6.5 Hp (4.5 kW)
- | Gjeresia e punimit: 900 mm
- | Thellesia e punimit: 150-300 mm

Kodi GC6101

**CMIMI**  
**49.900 LEK**



## TURRJELE TOKE ME BATERI

- | Motor pa karboncina per jetegjatesi sherbimi
- | Multifunksionale mund te perdoret dhe si perzjeresse kolli
- | Fale lirise qe ju ofron bateria mund te punoni dhe larg rrjetit elektrik
- | Trup celiku i fuqishem



**Einhell**

### TURRJELE MULTIFUNKSIONALE ME BATERI

- | Tensioni 18 V
- | Motor pa karboncina
- | 3 mënyra të ndryshme: në drejtim të kundërt, në drejtim të akrepave të orës: ECO & LARTË FUQI
- | Vetem trup

Kodi 34.370.00

CMIMI  
**19.000 LEK**

#### STARTER KIT

Set me bateri  
18 V / 4.0 + karikues



Art. 45.120.42  
CMIMI 7.500 Lek



**Einhell**

### TURRJELE SHPUESE

- | GP-EA
- | Diametri 120 mm
- | Gjatesia 80 cm

Kodi 34.370.10

CMIMI  
**4.500 LEK**



**Einhell**

### SHUFER PERZJERESSE KOLLI PER TURRJELEN ME BATERI

- | GP-EA
- | Diametri 120 mm

Kodi 34.370.11

CMIMI  
**2.290 LEK**



**Einhell**

### ZGJATUES PER TURRJELE TOKE

- | Gjatesia 1 m

Kodi 34.370.12

CMIMI  
**1.900 LEK**



### TURRJELE TOKE ME BATERI 20 V

- | Motori pa karboncina
- | Fuqia 20V/4.0Ah
- | + Turrjele 80 cm

Kodi CEALI208011

**CMIMI  
14.500 LEK**



### TURRJELE TOKE ME BENZINE

- | Motori 1E48F
- | Fuqia 2.2 kW
- | Madhesia motorit 63.3 cc
- | Kap. turrjeles 300 mm

Kodi DZ64S

**CMIMI  
25.500 LEK**

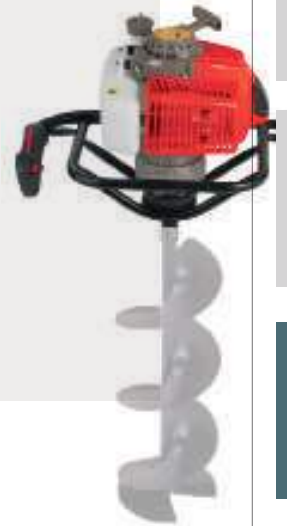

### TURRJELE TOKE ME BENZINE

- | Motori 1E44F-5A
- | Fuqia 1.4 kW
- | Madhesia motorit 51.7 cc
- | Kap. turrjeles 200 mm

Kodi DZ52

**CMIMI  
17.500 LEK**



### TURRJELE TOKE ME BENZINE

- | Motori 1E40/F-5A
- | Fuqia 1.25 kW
- | Madhesia motorit 42.7 cc
- | Kap. turrjeles 150 mm

Kodi DZ43

**CMIMI  
14.500 LEK**



**FORCE**  
EQUIPMENT - TOOLS



Turrjele shpuese

Kodi	Permase	Cmimi
DB80	80 mm	<b>4.100</b>
DB100	100 mm	<b>4.300</b>

**FORCE**  
EQUIPMENT - TOOLS



Turrjele shpuese

Kodi	Permase	Cmimi
DB150	150 mm	<b>4.500</b>
DB200	200 mm	<b>4.900</b>

**FORCE**  
EQUIPMENT - TOOLS



Turrjele shpuese

Kodi	Permase	Cmimi
DB250	250 mm	<b>5.900</b>
DB300	300 mm	<b>8.500</b>



# POMPA SPËRKATËSE ME BATERI

## KU PËRDOREN POMPAT ME BATERI?

### MBROJTJA E BIMËVE

- në ambiente të mëdha
- në serra / ferma / pemishte
- për pemë / bimë / lule
- kontrolli i barërave të këqija
- mbrojtje ndaj dëmtuesve
- mbrojtje ndaj sëmundjeve

- 1** Pompë e përshtatshme për të gjitha lëndët e lengshme
- 2** Grykë e gjërë mbushjeje
- 3** Shkop plastik rezistent 50 cm
- 4** Manometer për matjen e presionit
- 5** Fuçi me material plastik UV Lidhëse dhe mbajtëse komforte
- 6** Pompë elektrike me dy opsione për rregullimit e presionin dhe volumit
- 7** Bateri e fuqishme Lead Gel Rezistente
- 8** Tub 1.5 metra
- 9** Bateri 12V/8Ah



**WXDD-16D**

Presioni 0.2-0.4  
Depozita 16 Lt

**3.500 Lek**



**WXDD-18D**

Presioni 0.2-0.4  
Depozita 18 Lt

**3.700 Lek**



**WXDD-20D**

Presioni 0.2-0.4  
Depozita 20 Lt

**3.900 Lek**

NS2630

NAKAYAMA  
PMD



Çmimi  
**6.500**

NS2631

NAKAYAMA  
PMD



Çmimi  
**9.900**

**Sperkatese shpine me bateri**

Bateria 9 V  
Nr xhirove 4000-10000 rpm  
Depozita 5 lt+1 lt

34.252.40

**Einhell**



Çmimi  
**5.500**

**Sperkatese shpine me bateri**

Bateria 9 V  
Nr xhirove 4000-10000 rpm  
Depozita 5 lt+1 lt

WX768

**FORCE**  
MACHINERY - TOOLS



Çmimi  
**9.900**

**Sperkatese dore me bateri**

Bateria 18V (vetem trup)  
Depozita 1 L, Presioni 1.3 bar

3WF-3C

**FORCE**  
MACHINERY - TOOLS



Çmimi  
**8.900**

**Sperkatese shpine me benzine**

Motori me 2 kohe 26 cc / 0.65 kW  
Depozita 25 Lt  
Prurja max 5-7lt/min

3WF-3A

**FORCE**  
MACHINERY - TOOLS



Çmimi  
**8.900**

**Sperkates / Dezifektues**

Me benzine Motori WX-3C  
Depozita 14 L

**Sperkates / Dezifektues**

Me benzine Motori WX-3A  
Depozita 26 L

WX168F1-30A

**FORCE**  
MACHINERY - TOOLS



Çmimi  
**24.900**

WX168F1-30B

**FORCE**  
MACHINERY - TOOLS



Çmimi  
**24.900**

NS4010

**NAKAYAMA**  
PRO



Çmimi  
**29.900**

**Sperkatese ilaci me karroce**

Motorri HONDA 6.5 hp  
Prurja 35 l/min  
Tubi 100 m 8.5 mm

**Sperkatese ilaci me karroce**

Motorri HONDA 168F  
Fuqja 6.5 Hp  
Prurja 35 l/min Tubi 100 m 8.5

**Sperkatese ilaci**

Motorri 6.5 hp  
Prurja 22 l/min  
Presioni 45 bar

NS5210

**NAKAYAMA**  
PRO



Çmimi  
**35.900**

Grup pompe sperkatese me 3 piston

**FORCE**  
MACHINERY - TOOLS

**ERE**



11130-30

**GARDENA**

**MADE IN GERMANY**



Çmimi  
**3.790**

**Sperkatese ilaci me karroce**

Motorri me 2 kohe 26 cc  
Depozita 50 lt  
Tubi 30 m 8.5 mm

Kodi	Te dhena	Çmimi
WX22A-1	22lt/min, 45 Bar, 2HP	6.500
WX28A-1	37lt/min, 45 Bar, 5HP	7.900

**Sperkatese Mekanike**

Depozita 5 Lt

NS5000

**NAKAYAMA**  
PRO



Çmimi  
**1.590**

NS8000

**NAKAYAMA**  
PRO



Çmimi  
**1.900**

NS1602

**NAKAYAMA**  
PRO



Çmimi  
**2.550**

**Sperkatese mekanike**

Depozita 5 L

**Sperkatese Mekanike**

Depozita 8 L

**Sperkatese mekanike**

Depozita 16 L



HSP30102

**INGCO**

**ERE**



Çmimi  
**990**

**Sperkatese mekanike**

Depozita 1 L

HSP20202

**INGCO**



Çmimi  
**650**

**Sperkatese mekanike**

Depozita 2 L

HSP30502

**INGCO**



Çmimi  
**1.450**

**Sperkatese Mekanike**

Depozita 5 L

HSP30802

**INGCO**

**ERE**



Çmimi  
**1.690**

**Sperkatese Mekanike**

Depozita 8 L

HSP41602

**INGCO**



Çmimi  
**2.690**

**Sperkatese mekanike**

Depozita 16 L

HSP42002

**INGCO**

**ERE**



Çmimi  
**2.990**

**Sperkatese mekanike**

Depozita 20 L

WKS1516

**WADFLOW**

**ERE**



Çmimi  
**2.500**

**Sperkatese Shpine**

Depozita 16 Lt

WX-1.5LA

**FORCE**

**ERE**



Çmimi  
**350**

**Sperkatese dore plastike**

Depozita 1.5 L

WX-2.0LA

**FORCE**

**ERE**



Çmimi  
**450**

**Sperkatese dore plastike**

Depozita 2 L

49439



**solo**

Çmimi  
**550**

**Steke sperkatese**

Gjatesia 50 cm  
Hundes e sheshte

49445



**solo**

Çmimi  
**750**

**Zgjatues steke teleskopike**

Gjatesia 120-130 cm  
Materiali Karbon

49449



**solo**

Çmimi  
**950**

**Steke sperkatese**

Gjatesia 120 cm  
Materiali Fibra karboni

49513



**solo**

Çmimi  
**390**

**Zgjatues steke sperkatje**

Gjatesia 50 cm  
Materiali Plastik

49450



**solo**

Çmimi  
**550**

**Zgjatues steke fleksibel**

Gjatesia 15 cm  
Materiali Plastik

49478



**solo**

Çmimi  
**950**

**Zgjatues steke teleskopike**

Gjatesia 57-100 cm  
Materiali Bronz

49428



**solo**

Çmimi  
**550**

**Zgjatues steke sperkatje**

Gjatesia 75 cm  
Materiali Bronz

49528



**solo**

Çmimi  
**990**

**Zgjatues steke dyshe**

Gjatesia 150 cm  
Materiali Bronz

NS105



**NAKAYAMA**  
PRO

Çmimi  
**750**

**Steke sperkatese**

Gjatesia 60 cm  
Materiali Metalike

NS104



**NAKAYAMA**  
PRO

Çmimi  
**2.900**

**Steke sperkatese**

Gjatesia 60 cm  
Materiali Metalike

NS106



**NAKAYAMA**  
PRO

Çmimi  
**590**

**Steke sperkatese**

Gjatesia 60 cm  
Materiali Plastike

NS108



**NAKAYAMA**  
PRO

Çmimi  
**1.690**

**Steke sperkatese**

Gjatesia 60 cm  
Materiali Bronzi

NS130



Çmimi  
**890**

NS131



Çmimi  
**990**

Steke sperkatese Turbo



**Steke sperkatese**

Gjatesia 60 cm  
Materiali Metalike

**Steke sperkatese**

Gjatesia 90 cm  
Materiali Metalike

Kodi	Te dhena	Çmimi
NS132	30 cm / bronz	1.790
NS133	60 cm /.bronz	2.200

FS99

**ERE**



Çmimi  
**290**

WXC01



Çmimi  
**750**

WXC02



Çmimi  
**790**

**Steke per sperkatese me bateri**

Per sperkatese 16, 18, 20 Lt  
Material Metalike

**Steke sperkatese**

Gjatesia 30 cm  
Doreze metalike

**Steke sperkatese**

Gjatesia 30 cm  
Doreze Bronzi

WXC03



Çmimi  
**450**

WXC12



Çmimi  
**550**

WXC22



Çmimi  
**990**

**Steke sperkatese**

Gjatesia 30 cm  
Doreze Bronzi

**Steke sperkatese**

Gjatesia 30 cm  
Doreze Bronzi

**Steke sperkatese e drejte**

Gjatesia 60 cm  
Materiali Bronz

10101



Çmimi  
**100**

NS103



Çmimi  
**350**

NS109



Çmimi  
**250**

**Koke sperkatese**

Materiali Bronz

**Adaptor lidhes flutur**

Φ 8

**Rakorderi e shpejte femer**

1/2" per sperkatese



10112

**FORCE**



Çmimi  
**59**

**Koke sperkatese**

Materiali Plastike

10114

**FORCE**



Çmimi  
**69**

**Koke sperkatese dyshe**

Materiali Plastike

10115

**FORCE**



Çmimi  
**79**

**Koke sperkatese dyshe**

Materiali Plastike  
Dopio filetimit

10125

**FORCE**



Çmimi  
**59**

**Koke sperkatese e drejte**

Materiali Plastike  
Filetimi Mashkull

10126

**FORCE**



Çmimi  
**59**

**Koke sperkatese e drejte**

Materiali Plastike  
Filetimi Femer

10181

**FORCE**



Çmimi  
**190**

**Doreze steke sperkatese**

Materiali Plastike  
Perdorimi Universal

WX-103

**FORCE**



Çmimi  
**6.900**

**Tub sperkatese**

Gjatesia 100 m  
Diametri 8.5 mm 140 bar

WX-102

**FORCE**



Çmimi  
**7.900**

**Tub sperkatje me presion**

Gjatesia 100 m  
Diametri 8.5 mm

WX-BS128

**FORCE**



Çmimi  
**1.490**

**Bateri per sperkatese shpine**

Bateria 12 V / 8.0 Ah

WX-KS128

**FORCE**



Çmimi  
**450**

**Karikues**

Per sperkatese shpine 12 V / 8.0 Ah

WKW1815

**WALFOW**



Çmimi  
**350**

**Kane uji plastike**

Depozita 1.5 Lt

WKW1850

**WALFOW**



Çmimi  
**690**

**Kane uji plastike**

Depozita 5.0 Lt





**POMPA UJI, MOTOPOMPA**

**DHE GJENERATORE**





**KPM50**



**Pompe volumetrike**

Fuqia 0.37 kW  
Hedhja max. H=34 m  
Prurja max. Q=35 l/min

**KPM80**



**Pompe volumetrike**

Fuqia 0.6 kW  
Hedhja max. H=59 m  
Prurja max. Q=50 l/min

**CM22**



**Pompe centrifugale**

Fuqia 0.37 kW  
Hedhja max. H=20 m  
Prurja max. Q=100 l/min

**CM32/BR**



**Pompe centrifugale**

Fuqia 0.75 kW  
Hedhja max. H=29 m  
Prurja max. Q=125 l/min

**CM35**



**Pompe centrifugale**

Fuqia 1.15 kW  
Hedhja max. H=36 m  
Prurja max. Q=125 l/min

**CAM40**



**Pompe presioni**

Fuqia 0.6 kW  
Hedhja max. H=38 m  
Prurja max. Q=50 l/min

**CAM75**



**Pompe presioni**

Fuqia 0.6 kW  
Hedhja max. H=42 m  
Prurja max. Q=50 l/min

**CAM100**



**Pompe presioni**

Fuqia 0.75 kW  
Hedhja max. H=45 m  
Prurja max. Q=60 l/min

**CAM130**



**Pompe presioni**

Fuqia 1.0 kW  
Hedhja max. H=47 m  
Prurja max. Q=60 l/min





**CAM80**



Çmimi  
**17.900**

**Pompe presioni, trup inoxi**

Fuqia 0.6 kW  
Hedhja max. H=38 m  
Prurja max. Q=50 l/min

**2CM25/160C**



Çmimi  
**43.900**

**Pompe centrifugale me 2 helika**

Fuqia 1.1 kW / 230v  
Hedhja max. H=51 m Q=160 l/min  
Dalja e pompes 1" 1/4

**CBM303**



Çmimi  
**49.900**

**Pompe centrifugale per vaditje**

Fuqia 2.2 kW  
Hedhja max. H=17 m  
Prurja max. Q=1000 l/min  
Dalja e pompes 3"

**APM100**



Çmimi  
**29.900**

**Pompe me 2 thithje**

Fuqia 0.75 kW  
Hedhja max. H=36 m Q=35 l/min  
Lartesia max. H=30 m

**2CM25/160B**



Çmimi  
**43.900**

**Pompe centrifugale me 2 helika**

Fuqia 1.5 kW / 230v  
Hedhja max. H=58 m Q=160 l/min  
Dalja e pompes 1" 1/4

**RVM4**



Çmimi  
**29.000**

**Pompe centrifugale vertikale**

Fuqia 0.75 kW  
Hedhja max. H=46 m  
Prurja max. Q=90 l/min  
Dalja e pompes 1"

**APM150**



Çmimi  
**43.900**

**Pompe me 2 thithje**

Fuqia 1.1 kW  
Hedhja max. H=43 m / Q=35 l/min  
Lartesia max. H=46 m

**CBM203**



Çmimi  
**49.000**

**Pompe centrifugale per vaditje**

Fuqia 1.5 kW  
Hedhja max. H=16 m  
Prurja max. Q=900 l/min  
Dalja e pompes 3"

**PM20**



Çmimi  
**21.500**

**Pompe ushqimore**

Fuqia 0.37 kW  
Hedhja max. H=14 m  
Prurja max. Q=25 l/min  
Dalja e pompes Ø 20 mm

1  
2  
3  
4  
5  
6  
7  
8  
9  
10

PM25



Çmimi  
**29.900**

**Pompe ushqimore**

Fuqia 0.75 kW  
Hedhja max. H=19 m  
Prurja max. Q=55 l/min  
Dalja e pompes Ø 25 mm

RSM4



Çmimi  
**25.900**

**Pompe centrifugale horizontale**

Fuqia 0.75 kW  
Hedhja max. H=45 m  
Prurja max. Q=90 l/min  
Dalja e pompes 1"

RSM5



Çmimi  
**29.500**

**Pompe centrifugale horizontale**

Fuqia 1.1 kW  
Hedhja max. H=60 m  
Prurja max. Q=90 l/min  
Dalja e pompes 1"

SMC1103



Çmimi  
**31.900**

**Pompe zhytесе inoksi per puse**

Fuqia 1.0 kW  
Hedhja max. H=38 m  
Prurja max. Q=120 l/min  
Thellesia max e zhytjes. H=10 m

TSN300/S



Çmimi  
**14.500**

**Pompe zhytесе**

Fuqia 0.3 kW  
Hedhja max. H=6.5 m  
Prurja max. Q=90 l/min  
Thellesia max e zhytjes. H=5 m

TFE1000/S



Çmimi  
**24.900**

**Pompe zhytесе ugra te ndotura**

Fuqia 1.0 kW  
Hedhja max. H=11 m  
Prurja max. Q=240 l/min  
Thellesia max e zhytjes. H=5 m

SDC200



Per uje te paster

Çmimi  
**9.900**

**Pompe zhytесе**

Fuqia 0.20 kW  
Hedhja max. H=5 m  
Prurja max. Q=60 l/min  
Thellesia max e zhytjes. H=5 m

SDC300



Me galixhant elektrik

Per uje te paster

Çmimi  
**11.500**

**E RE**

**Pompe zhytесе**

Fuqia 0.3 kW  
Hedhja max. H=7 m  
Prurja max. Q=100 l/min  
Thellesia max e zhytjes. H=5 m

SDC550G



Me galixhant elektrik

Per uje te paster

Çmimi  
**12.500**

**E RE**

**Pompe zhytесе**

Fuqia 0.55 kW  
Hedhja max. H=8 m  
Prurja max. Q=165 l/min  
Thellesia max e zhytjes. H=5 m

SVC400



Per uje te ndotur

Çmimi

**11.500**

**Pompe zhytесе ujra te ndotura**

Fuqia 0.4 kW  
Hedhja max. H=7 m  
Prurja max. Q=140 l/min  
Thellesia max e zhytjes. H=5 m

SVC900



Per uje te ndotur

Çmimi

**14.500**

**Pompe zhytесе ujra te ndotura**

Fuqia 0.9 kW  
Hedhja max. H=9 m  
Prurja max. Q=230 l/min  
Thellesia max e zhytjes. H=5 m

SDX400



Per uje te paster

Çmimi

**14.900**

**Pompe zhytесе inoxi**

Fuqia 0.4 kW  
Hedhja max. H=7 m  
Prurja max. Q=110 l/min  
Thellesia max e zhytjes. H=5 m

SDX1100



Per uje te paster

Çmimi

**21.900**

**Pompe zhytесе inoxi**

Fuqia 1.1 kW  
Hedhja max. H=9 m  
Prurja max. Q=280 l/min  
Thellesia max e zhytjes. H=5 m

SVX550



Per uje te ndotur

Çmimi

**19.900**

**Pompe zhytесе ujra te ndotura**

Fuqia 0.55 kW  
Hedhja max. H=7 m  
Prurja max. Q=180 l/min  
Thellesia max e zhytjes. H=5 m

SVX1100



Per uje te paster

Çmimi

**22.500**

**Pompe zhytесе ujra te ndotura**

Fuqia 1.1 kW  
Hedhja max. H=10 m  
Prurja max. Q=250 l/min  
Thellesia max e zhytjes. H=5 m

41.707.42



Çmimi

**9.500**

**Pompe zhytесе inoxi**

Per ujra te pista  
Fuqia 1300 W / 230v  
Hedhja max. H=10 m  
Q= 23000 l/h

41.704.45



Çmimi

**7.900**

**Pompe zhytесе**

Per ujra te pista  
Fuqia 350 W / 230v  
Hedhja max. H=7.5 m  
Q= 8000 l/h

NP1120



Çmimi

**16.900**

**Pompe zhytесе**

Per ujra te paster  
Fuqia 1.0 kW / 230v  
Hedhja max. H=40 m  
Q= 6.500 l/min



### POMPE USHQIMORE NOVAX 14-M

- | Fuqia 480 W / 0.6 Hp
- | Prurja max. 14 Lt/min
- | Hedhja max. 12 m
- | Diameter 14 mm
- | Per varja



Kodi 800000

**CMIMI**  
**19.000 Lek**



### POMPE USHQIMORE NOVAX 20-B

- | Fuqia 0.50 Hp
- | Prurja max. 28 Lt/min
- | Hedhja max. 25 m
- | Diameter 20 mm
- | Per lengje deri 95°C



Kodi 964000 220

**CMIMI**  
**18.500 Lek**



### POMPE USHQIMORE NOVAX 25-B

- | Fuqia 660 W / 0.90 Hp
- | Prurja max. 45 Lt/min
- | Hedhja max. 10 m
- | Diameter 25 mm
- | Per lengje deri 95°C



Kodi 939000

**CMIMI**  
**25.900 Lek**



### POMPE USHQIMORE NOVAX 30-B

- | Fuqia 1000 W / 1.20 Hp
- | Prurja max. 85 Lt/min
- | Hedhja max. 10 m
- | Diameter 30 mm
- | Per lengje dhe vajra deri ne 95°C



Kodi 938000

**CMIMI**  
**34.900 Lek**



### POMPE USHQIMORE NOVAX 25-M

- | Fuqia 375 W / 0.9 Hp
- | Prurja max. 45 Lt/min
- | Hedhja max. 12 m
- | Diameter 25 mm
- | Per lengje deri 35°C (Jo-Vaj)



Kodi 998000

**CMIMI**  
**26.900 Lek**



### POMPE USHQIMORE ROVER 20

- | Fuqia 360 W / 0.5 Hp
- | Prurja max. 28 Lt/min
- | Hedhja max. 25 m
- | Diameter 25 mm
- | Per lengje (jo-vaj)
- | Material bronzi



Kodi 300000 CE

**CMIMI**  
**10.900 Lek**



### POMPE USHQIMORE ROVER 25

- | Fuqia 590 W / 0.8 Hp
- | Prurja max. 40 Lt/min
- | Hedhja max. 25 m
- | Diameter 25 mm
- | Per lengje (jo-vaj)
- | Material bronzi



Kodi 540000 CE

**CMIMI**  
**14.500 Lek**



### POMPE USHQIMORE ROVER 30 CE

- | Fuqia 1 Hp
- | Prurja max. 75 Lt/min
- | Hedhja max. 20 m
- | Diameter 30 mm
- | Per lengje (jo-vaj)
- | Material bronzi



Kodi 965000

**CMIMI**  
**19.900 Lek**



### POMPE USHQIMORE ROVER 40

- | Fuqia 1 Hp
- | Prurja max. 110 Lt/min
- | Hedhja max. 27 m
- | Diameter 20 mm
- | Per lengje (jo-vaj)
- | Material bronzi



Kodi 110000 CE

**CMIMI**  
**26.500 Lek**



### POMPE USHQIMORE NOVAX 20-M

- | Fuqia 0.5 Hp
- | Prurja max. 28 Lt/min
- | Hedhja max. 27 m
- | Diameter 20 mm
- | Per lengje (jo-vaj)



Kodi 790000

**CMIMI**  
**16.500 Lek**



### POMPE USHQIMORE NOVAX 40-M

- | Fuqia 1.2 Hp
- | Prurja max. 110 Lt/min
- | Hedhja max. 15 m
- | Diameter 40 mm
- | Per lengje (jo-vaj)



Kodi 750000

**CMIMI**  
**38.500 Lek**



### POMPE USHQIMORE NOVAX G 20 INOX

- | Fuqia 480 W / 0.6 Hp
- | Prurja max. 14 Lt/min
- | Hedhja max. 12 m
- | Diameter 14mm
- | Per vaj dhe lengje deri ne 35°C



Kodi 972000 I

**CMIMI**  
**33.000 Lek**



FB60



**FORCE**  
MACHINERY - TOOLS

Çmimi  
**4.500**

**Pompe volumetrike**

Fuqia 0.37 kW / 220 volt  
Lartesia max. H=35 m  
Prurja max. Q=35 l/min

FB70



**FORCE**  
MACHINERY - TOOLS

Çmimi  
**6.900**

**Pompe volumetrike**

Fuqia 0.55 kW / 220 volt  
Lartesia max. H=48 m  
Prurja max. Q=45 l/min

FB80



**FORCE**  
MACHINERY - TOOLS

Çmimi  
**8.900**

**Pompe volumetrike**

Fuqia 0.75 kW / 220 volt  
Lartesia max. H=53 m  
Prurja max. Q=45 l/min

FGP125T



**FORCE**  
MACHINERY - TOOLS

Çmimi  
**7.500**

**Pompe vakumi**

Fuqia 0.37 kW / 220 volt  
Lartesia max. H=35 m  
Prurja max. Q=35 l/min

FGP125



**FORCE**  
MACHINERY - TOOLS

Çmimi  
**6.900**

**Pompe vakumi**

Fuqia 0.37 kW / 220 volt  
Lartesia max. H=35 m  
Prurja max. Q=35 l/min

FCP130



**FORCE**  
MACHINERY - TOOLS

Çmimi  
**8.500**

**Pompe centrifugale**

Fuqia 0.37 kW / 220 volt  
Lartesia max. H=20 m  
Prurja max. Q=72 l/min

FCP146



**FORCE**  
MACHINERY - TOOLS

Çmimi  
**9.900**

**Pompe centrifugale**

Fuqia 0.55 kW / 220 volt  
Lartesia max. H=25 m  
Prurja max. Q=105 l/min

FCP158



**FORCE**  
MACHINERY - TOOLS

Çmimi  
**11.500**

**Pompe centrifugale**

Fuqia 0.75 kW / 220 volt  
Lartesia max. H=30 m  
Prurja max. Q=100 l/min

FCP170



**FORCE**  
MACHINERY - TOOLS

Çmimi  
**13.900**

**Pompe centrifugale**

Fuqia 1.1 kW / 220 volt  
Lartesia max. H=38/ m  
Prurja max. Q=120 l/min

FCP200



**FORCE**  
MACHINERY - TOOLS

Çmimi  
**14.900**

**Pompe centrifugale**

Fuqia 1.5 kW / 220 volt  
Lartesia max. H=41 m  
Prurja max. Q=120 l/min

FJSW/6M



**FORCE**  
MACHINERY - TOOLS

Çmimi  
**9.900**

**Pompe presioni**

Fuqia 0.37 kW / 220 volt  
Lartesia max. H=29 m  
Prurja max. Q=55 l/min

FJSW/10M



**FORCE**  
MACHINERY - TOOLS

Çmimi  
**11.500**

**Pompe presioni**

Fuqia 0.75 kW / 220 volt  
Lartesia max. H=34 m  
Prurja max. Q=70 l/min



FET100



Çmimi  
**11.500**

**Pompe presioni**

Fuqja 0.75 kW / 220 volt  
Lartesia max. H=40 m  
Prurja max. Q=50 l/min

FET150



Çmimi  
**17.900**

**Pompe presioni**

Fuqja 1.1 kW / 220 volt  
Lartesia max. H=55 m  
Prurja max. Q=80 l/min

FET200



Çmimi  
**19.900**

**Pompe presioni**

Fuqja 1.5 kW / 220 volt  
Lartesia max. H=50 m  
Prurja max. Q=130 l/min

FTQB60



Çmimi  
**11.900**

**Grup presioni automatik**

Fuqja 0.37 kW / 230 volt  
Lartesia max. H=35 m  
Prurja max. Q=35 l/min

FGJ800



Çmimi  
**10.500**

**Pompe presioni inoxi**

Fuqja 0.8 kW / 220 volt  
Lartesia max. H=46 m  
Prurja max. Q=50 l/min

SP1210



Çmimi  
**2.990**

**Pompe cekine me bateri**

Fuqja 80 W  
Lartesia max. H=5 m  
Prurja max. 4000 Lt/ore

FGDA-37



Çmimi  
**8.900**

INOKS

**Pompe Zhytесе 4"+10m kabull**

Fuqja 0.37 kW / 230 Volt  
Hedhja max. H=80 m  
Prurja max. Q=30 l/min

FGDA-50



Çmimi  
**9.900**

INOKS

**Pompe Zhytесе 4"+10m kabull**

Fuqja 0.50 kW / 230 Volt  
Hedhja max. H=80 m  
Prurja max. Q=41 l/min

FGDA-75



Çmimi  
**11.500**

INOKS

**Pompe Zhytесе 4"+10m kabull**

Fuqja 0.75 kW / 230 Volt  
Hedhja max. H=130 m  
Prurja max. Q=30 l/min

4FKM-75



Çmimi  
**14.900**

INOKS

**Pompe Zhytесе 4"+20m kabull**

Fuqja 0.75 kW / 230 Volt  
Hedhja max. H=61 m  
Prurja max. Q=42 l/min

4FKM-1.1



Çmimi  
**18.900**

INOKS

**Pompe Zhytесе 4"+30m kabull**

Fuqja 1.1 kW / 230 Volt  
Hedhja max. H=99 m  
Prurja max. Q=42 l/min

4FKM-1.5



Çmimi  
**22.500**

INOKS

**Pompe Zhytесе 4"+40m kabull**

Fuqja 1.5 kW / 230 Volt  
Hedhja max. H=140 m  
Prurja max. Q=58 l/min

4FRM405-K



Çmimi

**14.500**

INOKS

4FRM408-K



Çmimi

**14.900**

INOKS

4FRM410-K



Çmimi

**17.500**

INOKS

**Pompe Zhytесе 4"+20m kabull**

Fuqia 0.37 kW / 220 Volt  
Hedhja max. H=63 m, 5 helika  
Prurja max. Q=55 l/min

**Pompe Zhytесе 4"+30m kabull**

Fuqia 0.55 kW / 220 Volt  
Hedhja max. H=84 m, 8 helika  
Prurja max. Q=55 l/min

**Pompe Zhytесе 4"+30m kabull**

Fuqia 0.75 kW / 220 Volt  
Hedhja max. H=105 m, 10 helika  
Prurja max. Q=55 l/min

FK-0.37



Çmimi

**1.190**

**Kuader Elektrik**

Fuqia 0.37 kW  
Tensioni 230 Volt

FK-0.55



Çmimi

**1.290**

**Kuader Elektrik**

Fuqia 0.55 kW  
Tensioni 230 Volt

FK-0.75



Çmimi

**1.450**

**Kuader Elektrik**

Fuqia 0.75 kW  
Tensioni 230 Volt

4FRM414-K



Çmimi

**28.500**

INOKS

4FRM419-K



Çmimi

**29.900**

INOKS

4FRM426-K



Çmimi

**39.900**

INOKS

**Pompe Zhytесе 4"+40m kabull**

Fuqia 1.1 kW / 220 Volt  
Hedhja max. H=112 m, 14 helika  
Prurja max. Q=72 l/min

**Pompe Zhytесе 4"+50m kabull**

Fuqia 1.5 kW / 220 Volt  
Hedhja max. H=197 m, 19 helika  
Prurja max. Q=100 l/min

**Pompe Zhytесе 4"+50m kabull**

Fuqia 2.2 kW / 380 Volt  
Hedhja max. H=260 m, 26 helika  
Prurja max. Q=133 l/min

FK-1.1



Çmimi

**1.490**

**Kuader Elektrik**

Fuqia 1.1 kW  
Tensioni 230 Volt

FK-1.5



Çmimi

**1.590**

**Kuader Elektrik**

Fuqia 1.5 kW  
Tensioni 230 Volt

FK-2.2



Çmimi

**1.690**

**Kuader Elektrik**

Fuqia 2.2 kW  
Tensioni 230 Volt

**FFS-2**

**FORCE**  
 MACHINERY - TOOLS

Çmimi

**890**
**FFS-3**

**FORCE**  
 MACHINERY - TOOLS

Çmimi

**990**
**FFS-5**

**FORCE**  
 MACHINERY - TOOLS

Çmimi

**1.450**
**Galixhant pompe elektrike**

 Kabulli 2 m  
 Tensioni 230 Volt

**FORCE**  
 MACHINERY - TOOLS

**Kabull Petashuk**
**Çmimi/m**

125FCM-55	4x1.5 mm	<b>139</b>
125FCM-75	4x2.0 mm	<b>169</b>
125FCM-1.1	4x2.5 mm	<b>290</b>

**Galixhant pompe elektrike**

 Kabulli 3 m  
 Tensioni 230 Volt

**FNC-1K**

**FORCE**  
 MACHINERY - TOOLS

Çmimi

**4.500**
**Presostat pompe automatik**

 Fuqia 1.1 kW  
 Presioni 10 bar

**Galixhant pompe elektrike**

 Kabulli 5 m  
 Tensioni 230 Volt

**FORCE**  
 MACHINERY - TOOLS

Çmimi

**3.990**
**Presostat pompe automatik**

 Fuqia 1.1 kW  
 Presioni 10 bar

**FXH-2540**

**FORCE**  
 MACHINERY - TOOLS

Çmimi

**890**
**Set xhunduese**

Permasa : 25 mm x 40 cm

**007111770**
**SPERONI**  
 WATER PUMPS

MADE IN ITALY



Çmimi

**6.500**
**Rregullator presioni per pompa**

 Per pompa deri ne 1.1 kW  
 Lidhja 1" M, Shkalla e izolimit IP54

**FPS9A**

**FORCE**  
 MACHINERY - TOOLS

Çmimi

**990**
**Presostat Presioni me kabell**

 Tensioni 230 Volt  
 Presioni 0.05 - 0.15 Bar

**FA250**
**SPERONI**  
 WATER PUMPS

MADE IN ITALY



Çmimi

**3.990**
**Filter uji**

250 mm / 3.5 Bar

**PM5-F**
**SPERONI**  
 WATER PUMPS

MADE IN ITALY



Çmimi

**1.250**
**Presostat Presioni**

 Me rregullim presioni 1.6-3.2 bar  
 Lidhja 1/4" Femer  
 Shkalla e izolimit IP44

**CF250**
**SPERONI**  
 WATER PUMPS

MADE IN ITALY



Çmimi

**1.350**
**Kartuce rrjete per filtra uji**

63 mm - 243 mm

 1  
2  
3  
4  
5  
6  
7  
8  
9  
10



VPM37018



Çmimi

**4.500**

**Pompe volumetrike silencioze**

Fuqia 370 W  
Hedhja max. H=30 m  
Prurja max. Q=30 l/min

VPM3708



Çmimi

**4.500**

**Pompe volumetrike**

Fuqia 370 W  
Hedhja max. H=35 m  
Prurja max. Q=35 l/min

VPMS37082

Stainless steel  
pump head



Çmimi

**8.500**

**Pompe volumetrike, trup inoxi**

Fuqia 370 W  
Hedhja max. H=35 m  
Prurja max. Q=35 l/min

VPM5508



Çmimi

**7.500**

**Pompe volumetrike**

Fuqia 550 W  
Hedhja max. H=45 m  
Prurja max. Q=45 l/min

VPM7508



Çmimi

**7.500**

**Pompe volumetrike**

Fuqia 750 W  
Hedhja max. H=52 m  
Prurja max. Q=50 l/min

JP07508



Çmimi

**9.900**

**Pompe presioni**

Fuqia 750 W  
Hedhja max. H=51 m  
Prurja max. Q=55 l/min

JP11008



Çmimi

**11.900**

**Pompe presioni**

Fuqia 1100 kW  
Hedhja max. H=60 m  
Prurja max. Q=70 l/min

JP15008



Çmimi

**14.900**

**Pompe presioni**

Fuqia 1500 W  
Hedhja max. H=60 m  
Prurja max. Q=100 l/min

CPM3708



Çmimi

**6.900**

**Pompe centrifugale**

Fuqia 370 W  
Hedhja max. H=18 m  
Prurja max. Q=80 l/min

CPM5508



Çmimi

**9.900**

**Pompe centrifugale**

Fuqia 550 W  
Hedhja max. H=25 m  
Prurja max. Q=100 l/min

CPM7508



Çmimi

**9.900**

**Pompe centrifugale**

Fuqia 750 W  
Hedhja max. H=30 m  
Prurja max. Q=110 l/min

CPM15008



Çmimi

**16.900**

**Pompe centrifugale**

Fuqia 1500 W  
Hedhja max. H=45 m  
Prurja max. Q=140 l/min

**MHF150008**

**ERE**

 Çmimi  
**14.500**
**Pompe vaditje 2"**

 Fuqia 1500 W / 2 Hp  
 Hedhja max. H=18 m  
 Prurja max. Q=450 l/min

**MHF22001**

**ERE**

 Çmimi  
**18.500**
**Pompe vaditje 3"**

 Fuqia 2200 W / 3 Hp  
 Hedhja max. H=15 m  
 Prurja max. Q=800 l/min

**VPA37018**

Çmimi

**6.900**
**Pompe vakumi me depozite**

 Fuqia 370 W  
 Hedhja max. H=28 m  
 Prurja max. Q=30 l/min

**VPS3708**

 Çmimi  
**6.500**
**Pompe vakumi**

 Fuqia 370 W  
 Hedhja max. H=35 m  
 Prurja max. Q=32 l/min

**VPZ3708**

 Çmimi  
**7.500**
**Pompe vakumi**

 Fuqia 370 W  
 Hedhja max. H=35 m  
 Prurja max. Q=32 l/min

**JPS075082**

Çmimi

**9.900**
**Pompe presioni inoxi**

 Fuqia 750 W  
 Hedhja max. H=40 m  
 Prurja max. Q=55 l/min

**JPT07508**

 Çmimi  
**16.900**
**Pompe presioni automatike**

 Fuqia 750 W  
 Hedhja max. H=45 m  
 Prurja max. Q=60 l/min

**SPC4008**

 Çmimi  
**5.500**
**Pompe zhytесе / ujra te paster**

 Fuqia 400 W  
 Hedhja max. H= 8 m  
 Prurja max. Q=117 l/min

**SPD7501**

Çmimi

**8.900**
**Pompe zhytесе / ujra te ndotur**

 Fuqia 750 W  
 Hedhja max. H=8 m  
 Prurja max. Q=13.000 l/h

**SPD7508**

 Çmimi  
**6.900**
**Pompe zhytесе / ujra te ndotur**

 Fuqia 750 W  
 Hedhja max. H=8 m  
 Prurja max. Q=210 l/min

**SPD10001**

 Çmimi  
**9.900**
**Pompe zhytесе / ujra te ndotur**

 Fuqia 1000 W  
 Hedhja max. H=9 m  
 Prurja max. Q=333 l/min

**SPDB15008**

Çmimi

**19.900**
**INOKS**
**Pompe zhytесе / ujra te ndotur**

 Fuqia 1500 W  
 Hedhja max. H=14.5 m  
 Prurja max. Q=20 m<sup>3</sup>/h

1

2

3

4

5

6

7

8

9

10

**SPDB22008**



Çmimi  
**28.900**

**SPDS7508**



Çmimi  
**14.900**

**SPDS11008**



Çmimi  
**15.900**

**Pompe zhytесе Inoksi/ ujra pista**

Fuqia 2200 W  
Hedhja max. H=13 m  
Prurja max. Q=635 l/min

**Pompe zhytесе / ujra te ndotur**

Fuqia 750 W  
Hedhja max. H=13 m  
Prurja max. Q=18 m<sup>3</sup>/h

**Pompe zhytесе / ujra te ndotur**

Fuqia 1100 W  
Hedhja max. H=15 m  
Prurja max. Q=22 m<sup>3</sup>/h

**SPC3708**



Çmimi  
**8.900**

**SPC5508**



Çmimi  
**9.900**

**SPC7508**



Çmimi  
**11.500**

**Pompe zhytесе / ujra te paster**

Fuqia 370 W  
Hedhja max. H=17 m  
Prurja max. Q=1500 l/min

**Pompe zhytесе / ujra te paster**

Fuqia 550 W  
Hedhja max. H=25 m  
Prurja max. Q=6.5 m<sup>3</sup>/h

**Pompe zhytесе / ujra te paster**

Fuqia 750 W  
Hedhja max. H=32 m  
Prurja max. Q=120 l/min

**DWP3701**



Çmimi  
**14.500**

**DWP5501**



Çmimi  
**16.900**

**DWP7501**



Çmimi  
**18.500**

**Pompe pusi 4"**

Fuqia 370 W  
Hedhja max. H=48 m  
Nr. helikave 6

**Pompe pusi 4"**

Fuqia 550 W  
Hedhja max. H=64 m  
Nr. helikave 8

**Pompe pusi 4"**

Fuqia 750 W  
Hedhja max. H=80 m  
Nr. helikave 10

**DWP3701-SB**



Çmimi  
**1.790**

**DWP5501-SB**



Çmimi  
**1.890**

**DWP7501-SB**



Çmimi  
**1.990**

**Kuader elektrik**

Fuqia 370 W

**Kuader elektrik**

Fuqia 550 W

**Kuader elektrik**

Fuqia 750 kW



<p><b>DWP11001</b></p>  <p>Çmimi <b>19.900</b></p>	<p><b>DWP15001</b></p>  <p>Çmimi <b>24.900</b></p>	<p><b>DWP22001</b></p>  <p>Çmimi <b>27.500</b></p>
<p><b>Pompe pusi 4"</b></p> <p>Fuqia 1100 W Hedhja max. H=112 m Nr. helikave 14</p>	<p><b>Pompe pusi 4"</b></p> <p>Fuqia 1500 W Hedhja max. H=135 m Nr. helikave 17</p>	<p><b>Pompe pusi 4"</b></p> <p>Fuqia 2200 W Hedhja max. H=180 m Nr. helikave 23</p>
<p><b>DWP11001-SB</b></p>  <p>Çmimi <b>1.990</b></p>	<p><b>DWP15001-SB</b></p>  <p>Çmimi <b>2.190</b></p>	<p><b>DWP22001-SB</b></p>  <p>Çmimi <b>2.490</b></p>
<p><b>Kuader elektrik</b></p> <p>Fuqia 1100 W</p>	<p><b>Kuader elektrik</b></p> <p>Fuqia 1500 W</p>	<p><b>Kuader elektrik</b></p> <p>Fuqia 2200 W</p>
<p><b>SWP3701</b></p>  <p>Çmimi <b>9.900</b></p>	<p><b>SWP7501</b></p>  <p>Çmimi <b>11.900</b></p>	<p><b>WAPS001</b></p>  <p>Çmimi <b>2.650</b></p>
<p><b>Pompe pusi 3"</b></p> <p>Fuqia 370 W Hedhja max. H=72 m Prurja max. Q=25 l/min</p>	<p><b>Pompe pusi 3"</b></p> <p>Fuqia 750 W Hedhja max. H=103 m Prurja max. Q=33 l/min</p>	<p><b>Presostat pompe automatik</b></p> <p>Voltazhi 220 - 240V Presioni. 10 bar Diametri 1" x 1"</p>
<p><b>WAPS002</b></p>  <p>Çmimi <b>2.650</b></p>	<p><b>WPC1A01</b></p>  <p><b>I RI</b></p> <p>Çmimi <b>2.500</b></p>	<p><b>WWPQDC12</b></p>  <p><b>E RE</b></p> <p>Çmimi <b>3.500</b></p>
<p><b>Presostat pompe automatik</b></p> <p>Me manometer Presioni. 10 bar Diametri 1" x 1"</p>	<p><b>Presostat uji automatik</b></p> <p>Voltazhi 10A Presioni. 10 bar Diametri 1" x 1"</p>	<p><b>Pompe zhytесе / ujra te paster</b></p> <p>Fuqia 1700 W / 0.2 Hp Hedhja max 10 m Prurja max 50 Lt/min</p>

### POMPE UJI VOLUMETRIKE

**E RE**



**3.900**  
**WWPVA01**

Fuqia 370W  
Hedhja max 30m  
Prurja max 30Lt/min

### POMPE UJI CENTRIFUGALE

**E RE**



**7.900**  
**WWPCA03**

Fuqia 750W/1.0 Hp  
Hedhja max 28m  
Prurja max 100Lt/min

### POMPE UJI PRESIONI

**E RE**



**8.900**  
**WWPJA03**

Fuqia 750W/1.0Hp  
Hedhja max 45m  
Prurja max 50Lt/min

### POMPE ZHYTSESE PER UJRA TE PASTER

**E RE**



**4.500**  
**WWPFQ01**

Fuqia 400W/0.5 Hp  
Hedhja max 8m  
Prurja max 134Lt/min

### POMPE ZHYTSESE PER UJRA TE NDOTUR

**E RE**



**5.500**  
**WWPFW03**

Fuqia 750W/1.0 Hp  
Hedhja max 8m  
Prurja max 217Lt/min

### POMPE ZHYTSESE PER UJRA TE PASTER

**E RE**



**9.500**  
**WWPQA03**

Fuqia 750W/1.0 Hp  
Hedhja max 30m  
Prurja max 110Lt/min

### POMPE VOLUMETRIKE ME PANEL DIELLOR

**E RE**

**400W(0.5HP)**

**12.900**  
**WWPVDC01**

(Nuk perfshihet paneli diellor)

Fuqia 400W / 0.5Hp  
Hedhja max 45m  
Prurja max 41Lt/min



### POMPE CENTRIFUGALE ME PANEL DIELLOR

**E RE**

**550W(0.75HP)**

**16.900**  
**WWPCDC02**

(Nuk perfshihet paneli diellor)

Fuqia 550W/0.75Hp  
Hedhja max 32m  
Prurja max 91Lt/min



### POMPE UJI CENTRIFUGALE ME PANEL DIELLOR

**E RE**

**1500W(2.0HP)**

**29.900**

**WWPCDC051**

(Nuk perfshihet paneli diellor)

Fuqia 1500W/2.0Hp  
Hedhja max 26m  
Prurja max 716Lt/min



### POMPE ZHYTESE ME PANEL DIELLOR PER UJRA TE PASTER

**E RE**

**550W(0.75HP)**

**16.900**

**WWPQDC02**

(Nuk perfshihet paneli diellor)

Fuqia 550W/0.75Hp  
Hedhja max 25m  
Prurja max 100Lt/min

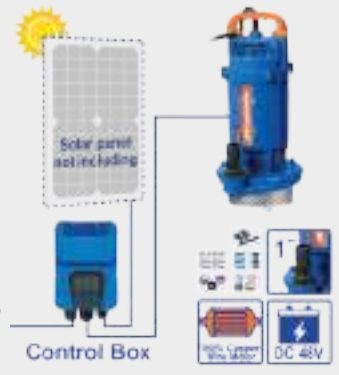

### POMPE ZHYTESE ME PANEL DIELLOR PER UJRA TE PASTER

**E RE**

**750W(1.0HP)**

**18.900**

**WWPQDC03**

(Nuk perfshihet paneli diellor)

Fuqia 750W/1.0Hp  
Hedhja max 25m  
Prurja max 233Lt/min



### POMPE ZHYTESE ME PANEL DIELLOR PER UJRA TE PASTER

**E RE**

**1100W(1.5HP)**

**22.900**

**WWPQDC04**

(Nuk perfshihet paneli diellor)

Fuqia 1100W/1.5Hp  
Hedhja max 36m  
Prurja max 266Lt/min



### POMPE PUSI ME PANEL DIELLOR 4"

**E RE**

**400W(0.5HP)**

**18.900**

**WWPDDC01**

(Nuk perfshihet paneli diellor)

Fuqia 400W/0.5Hp  
Hedhja max 36m  
Prurja max 5m<sup>3</sup>/h me 3 helikal

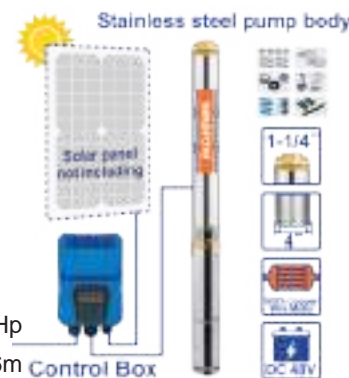

### POMPE PUSI ME PANEL DIELLOR 4"

**E RE**

**750W(1.0HP)**

**22.900**

**WWPDDC03**

(Nuk perfshihet paneli diellor)

Fuqia 750W/1.0Hp  
Hedhja max 63m  
Prurja max 6.5m<sup>3</sup>/h me 5 helika

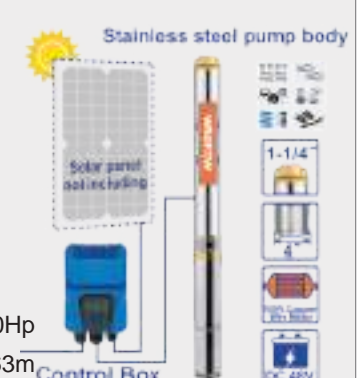

### POMPE PUSI ME PANEL DIELLOR 4'

**E RE**

**1100W(1.5HP)**

**22.900**

**WWPDDC04**

(Nuk perfshihet paneli diellor)

Fuqia 1100W/1.5Hp  
Hedhja max 87m  
Prurja max 6.5m<sup>3</sup>/h me 7 helika



### POMPE PUSI ME PANEL DIELLOR 4''

**E RE**

**1500W(2.0HP)**

**29.900**

**WWPDDC05**

(Nuk perfshihet paneli diellor)

Fuqia 1500W/2.0Hp  
Hedhja max 111m  
Prurja max 6.5m<sup>3</sup>/h me 9 helika







**MOTOPOMPE  
ME BENZINE**

- | Fuqja 2.5 HP
- | Prurja 100 l/min
- | Dalja 1"
- | Lartesia 16 m

Kodi GWP102

**CMIMI  
14.900 Lek**



**MOTOPOMPE  
ME BENZINE**

- | Fuqja 2.5 HP
- | Prurja 167 l/min
- | Dalja 1.5"
- | Lartesia 18 m

Kodi GWP152

**CMIMI  
15.900 Lek**



**MOTOPOMPE  
ME BENZINE**

- | Fuqja 7.0 HP
- | Prurja 550 l/min
- | Dalja 2"
- | Lartesia 28 m

Kodi GWP202

**CMIMI  
19.900 Lek**



**MOTOPOMPE  
ME BENZINE**

- | Fuqja 7.0 HP
- | Prurja 1000 l/min
- | Dalja 3"
- | Lartesia 32 m

Kodi GWP302

**CMIMI  
23.900 Lek**



**MOTOPOMPE  
ME BENZINE**

- | Fuqja 9.0 HP
- | Prurja 1500 l/min
- | Dalja 4"
- | Lartesia 30 m

Kodi GWP402

**CMIMI  
25.900 Lek**



**MOTOPOMPE  
ME NAFTE**

- | Fuqja 3.8 HP
- | Prurja 533 l/min
- | Dalja 2"
- | Lartesia 30 m

Kodi GEP201

**CMIMI  
29.900 Lek**



**INGCCO**

### MOTOPOMPE ME NAFTE

- | Fuqia 5.5 HP
- | Prurja 1000 l/min
- | Dalja 3"
- | Lartesia 28 m

Kodi GEP301

CMIMI  
**34.500 Lek**



**INGCCO**

### MOTOPOMPE ME NAFTE

- | Fuqia 8.3 HP
- | Prurja 1420 l/min
- | Dalja 4"
- | Lartesia 25 m

Kodi GEP401

CMIMI  
**49.900 Lek**



**LAUNTOP**

### MOTOPOMPE ME BENZINE

- | Fuqia 7 HP/208cc
- | Prurja 30 m<sup>3</sup> / h
- | Dalja 2"
- | Lartesia 25 m
- | Thithja max 8 m

Kodi LTP50C

CMIMI  
**18.900 Lek**



**LAUNTOP**

### MOTOPOMPE ME BENZINE

- | Fuqia 7 HP/208cc
- | Prurja 25 m<sup>3</sup> / h
- | Dalja 3"
- | Lartesia 25 m
- | Thithja max 8 m

Kodi LTP80C

CMIMI  
**19.900 Lek**



**LAUNTOP**

### MOTOPOMPE ME BENZINE

- | Fuqia 7 HP/208cc
- | Prurja 28 m<sup>3</sup> / h
- | Dalja 2"
- | Lartesia 35 m

Kodi LTF50C

CMIMI  
**29.900 Lek**



**LAUNTOP**

### MOTOPOMPE PRESIONI ME BENZINE

- | Fuqia 16 HP/420cc
- | Prurja 40 m<sup>3</sup> / h
- | Dalja 3"
- | Lartesia 65 m

Kodi LTF80C

CMIMI  
**39.900 Lek**



**LAUNTOP**

**MOTOPOMPE  
ME BENZINE IRON**

- | Fuqja 9.0 HP/270cc
- | Prurja 25 m<sup>3</sup> / h
- | Dalja 2"
- | Lartesia 55 m



Kodi LTTP50DC

CMIMI  
**29.900 Lek**

**LAUNTOP**

**MOTOPOMPE PRESIONI  
ME NAFTE IRON**

- | Fuqja 10 HP/418cc
- | Prurja 50 m<sup>3</sup> / h
- | Dalja 3"
- | Lartesia 65 m



Kodi LTTP80DC

CMIMI  
**34.500 Lek**

**LAUNTOP**

**MOTOPOMPE  
ME NAFTE KERMILL**

- | Fuqja 16 HP/460cc
- | Prurja 25 m<sup>3</sup> / h
- | Dalja 2"
- | Lartesia 55 m



Kodi LDTP50DC

CMIMI  
**52.500 Lek**

**LAUNTOP**

**MOTOPOMPE  
ME NAFTE KERMILL**

- | Fuqja 16 HP/460cc
- | Prurja 50 m<sup>3</sup> / h
- | Dalja 3"
- | Lartesia 65 m



Kodi LDTP80C

CMIMI  
**55.900 Lek**

**LAUNTOP**

**MOTOPOMPE  
ME NAFTE**

- | Fuqja 4.2 HP/211cc
- | Prurja 30 m<sup>3</sup> / h
- | Dalja 2"
- | Lartesia 25 m



Kodi LDP50C

CMIMI  
**39.500 Lek**

**LAUNTOP**

**MOTOPOMPE  
ME NAFTE**

- | Fuqja 5.4 HP/296cc
- | Prurja 50 m<sup>3</sup> / h
- | Dalja 3"
- | Lartesia 25 m



Kodi LDP80C

CMIMI  
**49.000 Lek**



**LAUNTOP**

**MOTOPOMPE ME NAFTE**

- | Fuqja 10 HP/418cc
- | Prurja 90 m<sup>3</sup> / h
- | Dalja 4"
- | Lartesia 25 m

Kodi LDP100CE

**CMIMI**  
**59.900 Lek**



**LAUNTOP**

**MOTOPOMPE PRESIONI ME NAFTE**

- | Fuqja 6.7 HP/296cc
- | Prurja 20 m<sup>3</sup> / h
- | Dalja 2"
- | Lartesia 55 m

Kodi LDF50C

**CMIMI**  
**37.900 Lek**



**LAUNTOP**

**MOTOPOMPE PRESIONI ME NAFTE**

- | Fuqja 10 HP/418cc
- | Prurja 40 m<sup>3</sup> / h
- | Dalja 3"
- | Lartesia 60 m

Kodi LDF80C

**CMIMI**  
**49.500 Lek**



**FORCE**  
MULTI-PURPOSE TOOLS

**MOTOPOMPE ME BENZINE ME 2 KOHE**

- | Fuqja 1.25 kW
- | Prurja 135 l/min
- | Dalja 1"
- | Lartesia 30 m

Kodi WP10G

**CMIMI**  
**13.500 Lek**



**FORCE**  
MULTI-PURPOSE TOOLS

**MOTOPOMPE ME BENZINE ME 2 KOHE**

- | Fuqja 1.25 kW
- | Prurja 250 l/min
- | Dalja 1.5"
- | Lartesia 35 m

Kodi WP15G

**CMIMI**  
**14.900 Lek**



**FORCE**  
MULTI-PURPOSE TOOLS

**MOTOPOMPE ME BENZINE**

- | Fuqja 6.5 HP / 196cc
- | Prurja 36.000 l/ore
- | Dalja 3"
- | Lartesia 23 m

Kodi WX-WP20

**CMIMI**  
**12.200 Lek**



**FORCE**  
MACHINERY - TOOLS

### MOTOPOMPE ME BENZINE

- | Fuqia 6.5 HP / 196cc
- | Prurja 60.000 l/ore
- | Dalja 3"
- | Lartesia 28 m

Kodi WX-WP30

CMIMI  
**13.500 Lek**



**FORCE**  
MACHINERY - TOOLS

### MOTOPOMPE ME BENZINE

- | Fuqia 9.5 HP / 389cc
- | Prurja 1330 l/min
- | Dalja 4"
- | Lartesia 28 m

Kodi WX-WP40

CMIMI  
**28.500 Lek**



**FORCE**  
MACHINERY - TOOLS

### MOTOPOMPE PRESIONI ME BENZINE

- | Fuqia 6.5 HP
- | Prurja 42.000 l/ore
- | Dalja 2"
- | Lartesia 65 m

Kodi WX-WP20H

CMIMI  
**14.900 Lek**



**FORCE**  
MACHINERY - TOOLS

### MOTOPOMPE PRESIONI ME BENZINE

- | Fuqia 10 HP
- | Prurja 40 m<sup>3</sup> / h
- | Dalja 3"
- | Lartesia 60 m

Kodi WX-WP30H

CMIMI  
**19.900 Lek**



**LAUNTOP**

### MOTOR ME BENZINE

- | Fuqia 208 cc
- | Fuqia 7.0 HP
- | Depozita 3.6 lt
- | Ftohje me ajer
- | Boshti i motorit 19 mm me kiavete

Kodi LT210

CMIMI  
**14.500 Lek**



**LAUNTOP**

### MOTOR ME BENZINE

- | Fuqia 270 cc
- | Fuqia 9.0 HP
- | Depozita 6 lt
- | Ftohje me ajer
- | Boshti i motorit 25.4 mm me kiavete

Kodi LT270

CMIMI  
**19.900 Lek**



**LAUNTOP**

### MOTOR ME BENZINE

- | Fuqia 420 cc
- | Fuqia 16 HP
- | Depozita 6 lt
- | Ftohje me ajer
- Boshti i motorit 25.4 mm me kiavete

**Kodi LT420**

**CMIMI  
29.500 Lek**



**FORCE**  
EQUIPMENT TOOLS

### MOTOR BENZINE ME KIAVETE

- | Fuqia 196 cc
- | Fuqia 6.5 HP
- | Depozita 3.6 lt
- | Ftohje me ajer
- Boshti i motorit konik/19 mm me kiavete

**Kodi WX-168F**

**CMIMI  
9.900 Lek**



**LAUNTOP**

### MOTOR NAFTE

- | Fuqia 211 cc
- | Fuqia 4.7 HP
- | Depozita 4.5 lt
- | Ftohje me ajer
- Boshti motorit 19 mm me kiavete

**Kodi LA170F**

**CMIMI  
29.900 Lek**



**LAUNTOP**

### MOTOR NAFTE

- | Fuqia 296 cc
- | Fuqia 6.7 HP
- | Depozita 3.5 lt
- | Ftohje me ajer
- Boshti i motorit 25.4 mm me kiavete

**Kodi LA178F**

**CMIMI  
35.900 Lek**



**LAUNTOP**

### MOTOR NAFTE ME MOTORRINO

- | Fuqia 418 cc
- | Fuqia 10 HP
- | Depozita 5.5 lt
- | Ftohje me ajer
- Boshti i motorit 25.4 mm me kiavete

**Kodi LA186FE**

**CMIMI  
45.900 Lek**



**INGCO**  
Professional Tools Made Affordable

### MOTOR ME BENZINE MOTOR 4 KOHESH

- | Fuqia 196 cc
- | Fuqia 13 HP
- | Ftohje me ajer
- Boshti i motorit 25.4 mm me kiavete

**Kodi GEN1882**

**CMIMI  
17.500 Lek**







### MOTOR BENZINE

- | Motori 105cc, 2.5HP
- | Shpejtësia e rrot.1800 rpm
- | Kapja me kjavete
- | Depozita e karburantit 1.2L
- | Depozita e vajit 0.4L

Kodi GWP102-SP-1

**CMIMI**  
**11.500 Lek**



### MOTOR BENZINE

- | Motori 208cc OHV, 7.0HP
- | Kapja 19mm
- | Shpejtësia e rrotullimit 1800 rpm
- | Depozita e karburantit 3.6L
- | Depozita e vajit 0.6L

Kodi GWP302-SP-1

**CMIMI**  
**12.500 Lek**



### MOTOR BENZINE PER KORRESE

- | Motori 141cc
- | Fuqia 3 0Kw, 4HP
- | Shpejtësia e rrot. 2600rpm
- | Depozita e karburantit 0.9L
- | Depozita e vajit 0.5L

Kodi GLM141181-SP-B25

**CMIMI**  
**14.500 Lek**



### MOTOR NAFTE

- | Motori 211cc, 3.8HP
- | Shpejtësia e rrot. 3600 rpm
- | Kapja me kjavete
- | Ftohje me ajer
- | Depozita e karburantit 12.5 L

Kodi GEP201-SP-50

**CMIMI**  
**27.500 Lek**



### MOTOR NAFTE

- | Motori 296cc, 5.5HP
- | Shpejtësia e rrot. 3600 rpm
- | Kapja 19mm me kjavete
- | Ftohje me ajer
- | Depozita e karburantit 12.5 L

Kodi GEP301-SP-59

**CMIMI**  
**29.500 Lek**



### MOTOR NAFTE

- | Motori 418cc, 8.3HP
- | Shpejtësia e rrot. 3600 rpm
- | Kapja me kjavete
- | Ftohje me ajer
- | Depozita e karburantit 12.5 L

Kodi GEP401-SP-59

**CMIMI**  
**39.500 Lek**



**GJENERATOR INVERTER  
ME BENZINE**



**IRI**

Motori me 4 kohe OHV  
Fuqia max ne dalje  
1.2 kW

Kodi GEI15006

CMIMI  
**38.900 Lek**



**GJENERATOR SILENCIOZ  
ME BENZINE INVERTER**



Motori me 4 kohe OHV  
Fuqia max ne dalje  
2.2 kW

Kodi GEI30001

CMIMI  
**55.500 Lek**



**GJENERATOR SILENCIOZ  
ME BENZINE INVERTER**



**IRI**

Motori me 4 kohe OHV  
Fuqia max ne dalje  
3.2 kW  
Ndezje me litar

Kodi GEI35006

CMIMI  
**64.500 Lek**



**GJENERATOR INVERTER  
ME BENZINE**



**IRI**

Motori me 4 kohe OHV  
Fuqia max ne dalje  
4.0 kW

Kodi GEI47506E

CMIMI  
**87.500 Lek**



**GJENERATOR TIGER ME  
BENZINE**



Motori me 2 kohe  
Fuqia max ne dalje 0.8 kW

Kodi GE8002

CMIMI  
**14.500 Lek**



**GJENERATOR ME  
BENZINE**



**IRI**

Motori me 4 kohe OHV  
Fuqia max ne dalje 1.2 kW

Kodi GE15005

CMIMI  
**24.900 Lek**





### GJENERATOR ME BENZINE

- | Motori me 4 kohe OHV
- | Fuqia max ne dalje 1.2 kW

Kodi GE150026

CMIMI  
**26.900 Lek**



### GJENERATOR ME BENZINE

- | Motori me 4 kohe OHV
- | Fuqia max ne dalje 2.8 kW

Kodi GE30005

CMIMI  
**28.900 Lek**



### GJENERATOR ME BENZINE

- | Motori me 4 kohe OHV
- | Fuqia max 3.5 kW

Kodi GE35006

CMIMI  
**39.900 Lek**



### GJENERATOR ME BENZINE

- | Motori me 4 kohe OHV
- | Fuqia max 3.5 kW
- Ndezje elektrike opsionale

Kodi GE35006ES

CMIMI  
**48.500 Lek**



### GJENERATOR ME BENZINE

- | Motori me 4 kohe OHV
- | Fuqia max ne dalje 5.5 kW
- | Ndezje elektrike opsionale

**DALJE DC/12V**

Kodi GE55003

CMIMI  
**55.900 Lek**



### GJENERATOR ME BENZINE

- | Motori me 4 kohe OHV
- | Fuqia max ne dalje 6.5 kW
- | Ndezje elektrike opsionale

Kodi GE65006

CMIMI  
**69.900 Lek**





## GJENERATOR ME BENZINE

**INGCO**  
Professional Tools Made Affordable

- | Motori me 4 kohe OHV
  - | Fuqia max ne dalje 9.0 kW
  - | Ndezje elektrike
- Kodi GE90006

**IRI**

CMIMI  
**75.900 Lek**



## GJENERATOR ME NAFTE

**INGCO**  
Professional Tools Made Affordable

DALJE DC/12V

- | Motori 5.7 HP
- | Fuqia max ne dalje 3.0 kW

Kodi GDE30001

CMIMI  
**69.900 Lek**



## GJENERATOR ME NAFTE

**INGCO**  
Professional Tools Made Affordable

- | Motori me 4 kohe OHV
  - | Fuqia max ne dalje 5.0 kW
  - | Ndezje elektrike opsionale
- Kodi GDE50001

DALJE DC/12V

CMIMI  
**99.500 Lek**



## GJENERATOR ME NAFTE TREFAZOR

**INGCO**  
Professional Tools Made Affordable

- | Motori 9.0 HP
- | Fuqia max ne dalje 5.0 kW
- | Ndezje elektrike

**IRI**

Kodi GDE50003

CMIMI  
**95.900 Lek**



## RREGULLATOR TENSIONI

**INGCO**  
Professional Tools Made Affordable

- | Tensioni 5 kVA
- | Peshja 25 kg

Kodi VS503

CMIMI  
**28.900 Lek**



## RREGULLATOR TENSIONI

**INGCO**  
Professional Tools Made Affordable

- | Tensioni 10 kVA
- | Peshja 35 kg

Kodi VS1003

CMIMI  
**48.900 Lek**



### GJENERATOR SILENCIOZ ME NAFTE

- | Motori 13.0 HP / 3 FAZOR
- | Fuqia max ne dalje 8.0 kW
- | Ndezje elektrike
- | Numri i xhirove 3000 rpm
- | Depozita 25 Lt
- | Pesha 236 kg

Kodi GSE80003

**CMIMI**  
**199.500 Lek**

**IRI**



**8kW**

Three phase



Low Noise



Diesel



Electric Start



### GJENERATOR SILENCIOZ ME NAFTE

- | Motori 12.0 HP
- | Fuqia max ne dalje 6.5 kW
- | Ndezje elektrike
- | Numri i xhirove 3000 rpm
- | Depozita 17 Lt
- | Pesha 173 kg

Kodi GSE65001

**CMIMI**  
**139.500 Lek**



**6.5kW**

Single phase



Low Noise



Diesel



Electric Start



### GJENERATOR SILENCIOZ ME NAFTE

- | Motori 9.0 HP / 3 FAZOR
- | Fuqia max ne dalje 5.0 kW
- | Ndezje elektrike
- | Numri i xhirove 3000 rpm
- | Depozita 15 Lt
- | Pesha 172 kg

Kodi GSE50003

**CMIMI**  
**116.500 Lek**

**IRI**

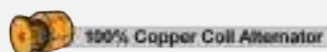

**5kW**

Three phase



Low Noise



Diesel



**LAUNTOP****GJENERATOR SILENCIOZ ME NAFTE**

- | Motori LA188F
  - | Fuqia max ne dalje 5.0 / 5.3 kW
  - | Ndezje elektrike opsionale
- Kodi LDG6500SA**

**CMIMI**  
**139.000 Lek**

**LAUNTOP****GJENERATOR ME NAFTE**

- | Motori LA186FA
  - | Fuqia max ne dalje 4.5 / 5.0 kW
  - | Ndezje elektrike opsionale
- Kodi LDG6000CLE**

**CMIMI**  
**99.900 Lek**

**LAUNTOP****GJENERATOR ME NAFTE**

- | Motori LA170F
  - | Fuqia max ne dalje 1.7 / 2.0 kW
  - | Ndezje elektrike opsionale
- Kodi LDG2200CLE**

**CMIMI**  
**79.900 Lek**

**LAUNTOP****GJENERATOR ME BENZINE**

- | Motori 208 cc
  - | Fuqia 2.5 / 2.58 kW
- Kodi LT3500CLE**

**CMIMI**  
**42.500 Lek**

**LAUNTOP****GJENERATOR ME BENZINE PORTABEL**

- | Motori me 2 kohe
  - | Madhesia motorit 87 cc
  - | Fuqia max 0.9 / 1.0 kW
- Kodi LT1200CL**

**CMIMI**  
**19.900 Lek**

**LAUNTOP****GJENERATOR PORTABEL ME BENZINE**

- | Motori me 2 kohe
  - | Madhesia motorit 63 cc
  - | Fuqia max 0.72 kW
- Kodi LT950DC**

**CMIMI**  
**13.900 Lek**





## SHKUNDESE ULLIRI

Proces super i thjeshte fale baterise apo motorit i cili ben te mundur levizjen e shpejte te kokes dhe rrjedhimisht shkundjen e plote te degeve.

Vjelja me rrjete e ullirit eshte me e mira qe mund te besh pasi parandalon humbjen e kokrave dhe ndotjen e tyre.



**MINOSNIK**  
AND TO 1999

### SHKUNDESE ULLIRI GOLD CARBON

- Me koke karboni
- Gjatesia: 2.4m tub
- Rendimenti: 200 kg/ore
- Kabulli: 15 metra 2 X 3 MM
- 1.4 m tub
- Voltazhi: 12 V / 24 V

Kodi 920001

**CMIMI**  
**39.900 Lek**

**CARBON HEAD**



**Loncin**

### GJENERATOR DINAMO LONCIN

- Fuqia max AC: 1.5 KVa
- Fuqia max DC: 12 V / 60 A
- Fuqia e motorit: 6.5 Hp
- Motor me 4 koke 196 cm3
- Depozita 3.6 Lt

Kodi 920000

**CMIMI**  
**49.900 Lek**



Rrjete per ullinj

Modeli	Permasa	Çmimi
SN7050	90gr 6x12m	<b>5.990</b>
SN7100	90gr 7x12m	<b>6.900</b>
SN7150	90gr 7x14m	<b>8.500</b>
SN7200	90gr 8x12m	<b>8.500</b>
SN7250	90gr 8x14m	<b>8.900</b>

920009



Çmimi  
**14.900**

Bateri makine per shkundes ulliri

12 V / 80 Ah



## SHKUNDESE ULLIRI ME BATERI GE-FS

- | Gjeresi punimi 53 cm
- | Koke karboni / Trup alumini
- | Gjatesia max 310 cm
- | Vetem trup

Kodi 34.114.00

**CMIMI**  
**21.500 Lek**

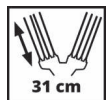

### STARTER KIT

Set me bateri  
18 V / 4.0 + karikues



Art. 45.120.42  
CMIMI 7.500 Lek



**P20S**

## SHKUNDESE ULLIRI ME BATERI

- | Fuqia 2x40V/4.0Ah
- | Motor pa karboncina
- | Gjeresi punimi 38 cm

Kodi COHLI200386

**CMIMI**  
**34.900 Lek**



Removable

<p>03.01</p>  <p>Çmimi <b>120</b></p>	<p>03.05</p>  <p>Çmimi <b>130</b></p>	<p>03.09</p>  <p>Çmimi <b>190</b></p>
<p><b>KREHER PER VJELJE I DREJTE PLASTIK 102</b></p> <p>Nr i dhembeve 10</p> <p>Gjeresia 30 cm</p>	<p><b>KREHER PER VJELJE I HARKUAR PLASTIK 103</b></p> <p>Nr i dhembeve 11</p> <p>Gjeresia 30 cm</p>	<p><b>KREHER PER VJELJE I HARKUAR PLASTIK 104</b></p> <p>Nr i dhembeve 9</p> <p>Gjeresia 30 cm</p>
<p>03.13</p>  <p>Çmimi <b>190</b></p>	<p>03.21</p>  <p>Çmimi <b>450</b></p>	<p>03.18</p>  <p>Çmimi <b>210</b></p>
<p><b>KREHER PER VJELJE I HARKUAR PLASTIK 105</b></p> <p>Nr i dhembeve 9</p> <p>Gjeresia 30 cm</p>	<p><b>KREHER PER VJELJE I HARKUAR PLASTIK 106</b></p> <p>Nr i dhembeve 13</p>	<p><b>KREHER PER VJELJE I HARKUAR</b></p> <p>Nr i dhembeve 9</p>
<p>03.32</p>  <p>Çmimi <b>750</b></p>	<p>04.17</p>  <p>Çmimi <b>1.290</b></p>	<p>04.16</p>  <p>Çmimi <b>1.490</b></p>
<p><b>KREHER PER VJELJE I HARKUAR PLASTIK 111</b></p> <p>Nr i dhembeve 10</p>	<p><b>KREHER MBLEDHES METALIK ME KOKE TE RREGULLUESHME 700 A</b></p> <p>Nr i dhembeve 22</p>	<p><b>KREHER MBLEDHES METALIK ME KOKE TE RREGULLUESHME 7004</b></p> <p>Nr i dhembeve 22</p>



## BLUARSE DRITHRASH

! Përdoret për të bluar një shumëllojshmëri të gjerë të drithërave, fasuleve dhe orizit.

! Është projektuar që të jetë i lehtë për t'u përdorur dhe pastruar, dhe motori i tij ofron fuqi të fuqishme bluarjeje.

! Bluarsi i drithrave është gjithashtu shumë i aftë të ruajë shijen e ushqimit që bluan fale mekanizmit special te bluarjes. Së fundi, aftësia e tij për të bluar një shumëllojshmëri të gjerë ushqimesh e bën atë një zgjedhje të shkëlqyer për ata që kërkojnë shkathtësi në kuzhinën e tyre.



**NAKAYAMA**  
PRO

### BLUARSE DRITHRASH

- ! Fuqia 1.5 Hp
- ! Prodhimi 240 kg/h
- ! Me 4 slita: 2, 5, 5, 6 mm

Kodi FM1100

CMIMI  
**16.900 Lek**



**FORCE**  
MOTORRY TOOLS

### BLUARSE MISRI

- ! Fuqia 2200 W
- ! Produktiviteti 68 kg/h
- ! Nr rrotullimeve 1500 rpm

Kodi 6NF-140

CMIMI  
**9.900 Lek**



**FORCE**  
MOTORRY TOOLS

### BLUARSE DRITHRASH

- ! Fuqia 1.1 KW (1.5 Hp)
- ! Produktiviteti 240 kg/h
- ! Nr rrotullimeve 2900 r/min

Kodi CM-1.1B

CMIMI  
**7.900 Lek**



**FORCE**  
MOTORRY TOOLS

### BLUARSE DRITHRASH

- ! Fuqia 2.2 KW (3.0 Hp)
- ! Produktiviteti 600 kg/h
- ! Nr rrotullimeve 2900 r/min

Kodi CM-2.0D

CMIMI  
**26.900 Lek**



### SHKERMQESE PER KALLI MISRI

- Fuqja 0.55 kW
- Produktiviteti 180 kg/h
- Nr rrotullimeve 2900 r/min

Kodi 5STY-40-90

**CMIMI**  
**9.900 Lek**



### SHKERMQESE PER KALLI MISRI

- Fuqja 0.75 kW (1.0 Hp)
- Produktiviteti 240 kg/h
- Nr rrotullimeve 2900 r/min

Kodi 5STY-50-90

**CMIMI**  
**12.500 Lek**



### SHTRYDHESE RRUSHI MEKANIKE

- Produktiviteti 180 kg/h
- E emaluar per mbrojte nga faktoret atmosferik dhe ato kimik

Kodi HGP-50  
**CMIMI**  
**4.500 Lek**



### SHTRYDHESE RRUSHI ELEKTRIKE

- Fuqja 0.55 kW (0.75 Hp)
- Produktiviteti 280 kg/h
- Nr rrotullimeve 2900 r/min

Kodi HGP-60  
**CMIMI**  
**9.900 Lek**



**ELEKTRIKE**



#### Thike komplet per bluarsen CM-1.1B

Kodi	Per bluarsen	Cmimi
THK1.1B	CM-1.1B	<b>1.350</b>



#### Kapak rezerve per bluarsen

Kodi	Permasa	Cmimi
KBL1	Per CM-1.1B	<b>3.590</b>

#### Site per bluarsen CM-1.1B

Kodi	Permasa	Cmimi
ST1	1"	<b>230</b>
ST2	2"	<b>260</b>
ST3	3"	<b>310</b>
ST4	4"	<b>340</b>
ST5	5"	<b>430</b>



#### Cilinder i brendshem HGP50/HGP60

Kodi	Permasa	Cmimi
INB-50/60	1"	<b>2.500</b>



#### Cilinder i jashtem per HGP50/HGP60

Kodi	Permasa	Cmimi
INO-50	HGP50	<b>220</b>
INO-60	HGP60	<b>590</b>





**LAVAZHE DHE**

**FSHESA ME KORENT**



Gamë e gjeneratës së zgjuar  
Zgjerimi i performancës me

## DUEL TECHNOLOGIES



### Lavazh ARXP SMART BOX5 DSS



- | Fuqia 2700W,
- | Presioni 160Bar,
- | Konsumi 850l/h,
- | Me aksesore dhe 3 koka



Kodi 15452

**CMIMI**  
**29.900 Lek**



### Lavazh ARXP SMART BOX4 DSS



- | Fuqia 2500W,
- | Presioni 180Bar,
- | Konsumi 500l/h,
- | Me aksesore



Kodi 15453

**CMIMI**  
**25.900 Lek**



### Lavazh ARXP SMART BOX3 LHT



- | Fuqia 1900W,
- | Presioni 150Bar,
- | Konsumi 460l/h,
- | Me aksesore



Kodi 15454

**CMIMI**  
**22.900 Lek**



## LAVAZH ME BATERI

- Te pajisura me një motor të fuqishëm që është në gjendje t'ju japë shumë fuqi pastrimi për të përballuar edhe punët më të vështira.
- Dizajni kompakt i tyre ju mundeson ruajtjen dhe transportin e lehtë, duke i bërë ato ideale si për përdorim shtëpiak ashtu edhe për profesional.
- Te pajisura me një sërë aksesorësh, të tillë si rezervuar sapuni dhe pistoletë spërkatëse të rregullueshme, të cilat i bëjnë ato të përshtatshëm për pastrimin e një sërë sipërfaqesh.



### LAVAZH ME BATERI

- Me 1 bateri 20 V / 2.0 Ah
- Presioni 24.8 bar
- Prurja 2.2 l/min

Kodi CPWLI20082

**CMIMI  
9.900 Lek**



### LAVAZH PROFESIONAL

- Fuqia 7.5 hp
- Presioni 200 bar
- Konsumi 15 l/min
- Testate e nikeluar



Kodi MODEL2

**CMIMI  
99.500 Lek**



### LAVAZH PROFESIONAL

- Fuqia 7.5 hp
- Presioni 200 bar
- Konsumi 15 l/min
- Testate bronxi



Kodi MODEL5

**CMIMI  
89.500 Lek**

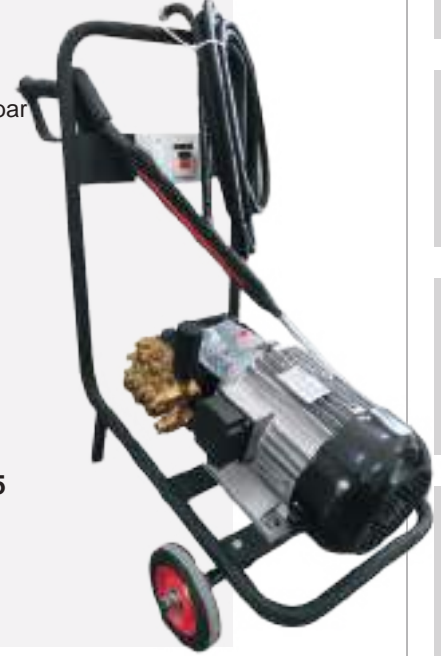

### LAVAZH MOD 630K I KOMPLETUAR

- | Fuqia 2600 W
- | Presioni 120 bar
- | Konsumi 600 l/h
- | Monofaze



Kodi 14633

**CMIMI**  
**79.500 Lek**



### LAVAZH MOD 630

- | Fuqia 2600 W
- | Presioni 120 bar
- | Konsumi 600 l/h
- | Monofaze



Kodi 12360

**CMIMI**  
**75.900 Lek**



### LAVAZH MOD 591

- | Fuqia 2.8 KW
- | Presioni 180 bar
- | Konsumi 600 l/h



Kodi 14990

**CMIMI**  
**59.900 Lek**



### LAVAZH MOD 5 TWIN ME 2 MOTORA

- | Fuqia 2.7 KW
- | Presioni 160 bar
- | Konsumi 850 l/h
- | Grupi Alumin



Kodi 14793

**CMIMI**  
**49.900 Lek**



### LAVAZH MOD 4 TWIN ME 2 MOTORA

- | Fuqia 2500 W
- | Presioni 150 bar
- | Konsumi 810 l/h
- | Grupi Alumin



Kodi 14792

**CMIMI**  
**35.900 Lek**



### LAVAZH IDROP 2NE1 DHE SPERKATES

- | Fuqia 2200 W
- | Presioni 160 bar
- | Konsumi 420 l/h



Kodi 15153

**CMIMI**  
**19.900 Lek**





### LAVAZH MOD 475

- Fuqia 2000 W
- Presioni 160 bar
- Konsumi 480 l/h



Kodi 14328

**CMIMI**  
**16.900 Lek**



### LAVAZH MOD 387

- Fuqia 1.9 kW
- Presioni 150 bar
- Konsumi 420 l/h



Kodi 15458

**CMIMI**  
**14.900 Lek**



### LAVAZH IDROP ARBC

- Fuqia 1400 W
- Presioni 120 bar
- Konsumi 390 l/h



Kodi 15147

**CMIMI**  
**9.900 Lek**



### LAVAZH MOD 117 TSS

- Fuqia 1300 W
- Presioni 100 bar
- Konsumi 390 l/h
- Grup Alumini



Kodi 13689

**CMIMI**  
**8.900 Lek**



### LAVAZH

- Fuqia 2000 W
- Presioni 150 bar
- Prurja 450 l/min



Kodi BPW2610

**CMIMI**  
**14.900 Lek**



### LAVAZH

- Fuqia 1600 W
- Presioni 135 bar
- Prurja 408 l/min



Kodi BPW2210

**CMIMI**  
**13.500 Lek**



ingco

## LAVAZH PROFESIONAL

- | Fuqia 2400 W
- | Presioni 100 bar
- | Prurja 10 l/min

Kodi HPWR30018

**CMIMI**  
**29.900 Lek**



ingco

## LAVAZH

- | Fuqia 2800 W
- | Presioni 180 bar
- | Prurja 7.3 l/min

Kodi HPWR28008

**CMIMI**  
**28.900 Lek**



ingco

## LAVAZH

- | Fuqia 2500 W
- | Presioni 160 bar
- | Prurja 6.0 l/min

Kodi HPWR25008

**CMIMI**  
**25.500 Lek**



ingco

## LAVAZH

- | Fuqia 2000 W
- | Presioni 150 bar
- | Prurja 6.0 l/min

Kodi HPWR20008

**CMIMI**  
**19.500 Lek**



ingco

## LAVAZH

- | Fuqia 1800 W
- | Presioni 150 bar
- | Prurja 6.0 l/min

Kodi HPWR18008

**CMIMI**  
**12.500 Lek**



ingco

## LAVAZH

- | Fuqia 1400 W
- | Presioni 130 bar
- | Prurja 5.5 l/min

Kodi HPWR14008

**CMIMI**  
**8.500 Lek**



1  
2  
3  
4  
5  
6  
7  
8  
9  
10

**INGCO**

### LAVAZH

- | Fuqia 1200 W
- | Presioni 90 bar
- | Prurja 5.5 l/min

**Kodi HPWR12008**

**CMIMI**  
**7.500 Lek**



**WAPOW**

### LAVAZH

- | Fuqia 1400 W
- | Presioni 110 bar
- | Prurja 5.6 l/min

**Kodi WHP3A14**

**CMIMI**  
**6.900 Lek**



**AR** ANNOVI  
REVERBERI

### GRUP LAVAZHI RK 15.20 H N

- | Grup me 3 pistonë seria 322RR
- | Presioni 200 bar
- | Prurja max 15 l/min
- | Pershtatet me motore 7.5 Hp

**MADE IN ITALY**

**Kodi 20638**

**CMIMI**  
**39.900 Lek**



**AR** ANNOVI  
REVERBERI

### GRUP LAVAZHI RR 15.20 N

- | Grup me 3 pistonë seria
- | Presioni 200 bar
- | Prurja max 15 l/min
- | Pershtatet me motore 7.5 Hp

**MADE IN ITALY**

**Kodi 23507**

**CMIMI**  
**35.900 Lek**



**AR** ANNOVI  
REVERBERI

### GRUP LAVAZHI HRK15.20N ME MOTOR

- | Grup me 3 pistonë seria
- | Presioni 200 bar
- | Prurja max 15 l/min
- | Pershtatet me motore 7.5 Hp

**MADE IN ITALY**

**Kodi 23021**

**CMIMI**  
**87.900 Lek**



**AR** ANNOVI  
REVERBERI

### GRUP LAVAZHI HRR 15.20N ME MOTOR

- | Grup me 3 pistonë seria 322RR
- | Presioni 200 bar
- | Prurja max 15 l/min
- | Pershtatet me motore 7.5 Hp

**MADE IN ITALY**

**Kodi 23979**

**CMIMI**  
**79.500 Lek**





### ASPIRATOR ME 2 MOTORA 4300P

- Fuqia 2400 W
- Depozita 77 lt
- Thithja 22.1 kpa



Kodi 52509

**CMIMI**  
**49.900 Lek**



### ASPIRATOR INOXI 4700S

- Fuqia 1600 W
- Depozita 36 lt
- Thithja 23.5 kpa



Kodi 51065

**CMIMI**  
**39.900 Lek**



### ASPIRATOR MOD 3670

- Fuqia 1600 W
- Depozita 30 lt
- Thithja 19 kpa
- Thithje pluhur dhe uje

Kodi 51927

**CMIMI**  
**15.500 Lek**



### ASPIRATOR ME 3 MOTORA PROFESIONAL

- Fuqia 3000 W
- Depozita 80 lt inox
- Thithja 9700L/min
- Thithje pluhur dhe uje

Kodi BVC7510

**CMIMI**  
**39.000 Lek**



### ASPIRATOR INOXI

- Fuqia 1200 W
- Depozita 20 lt
- Me te njome dhe te thate
- Me aksesore

Kodi BVC2600

**CMIMI**  
**6.900 Lek**



### LAVAMOKET

- Fuqia 1400 W
- Depozita 20 lt

Kodi BVC4100

**CMIMI**  
**14.900 Lek**



### ASPIRATOR ME BATERI

- | Bateria: 20 V
- | Depozita 20 lt
- | Thithja 8 kpa
- | Thithje pluhur
- | Vetem trup

Kodi CVLI2005E

CMIMI  
**8.500 Lek**



**P20S**



### ASPIRATORE INOXI ME 2 MOTORA

- | Fuqia 2400 w
- | Depozita 75 lt
- | Thithja 16-17 kpa
- | Thithje pluhur dhe uje

Kodi VC24751

CMIMI  
**28.500 Lek**



### ASPIRATOR

- | Fuqia 1400 w
- | Depozita 30 lt
- | Thithja 16-18 kpa
- | Thithje pluhur dhe uje

Kodi VC14301

CMIMI  
**11.900 Lek**



**ingcco**



### ASPIRATOR

- | Fuqia 1300 w
- | Depozita 30 lt
- | Thithja 16 kpa
- | Thithje pluhur dhe uje

Kodi VC13301

CMIMI  
**8.500 Lek**



**ingcco**

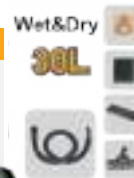

### ASPIRATOR

- | Fuqia 800 w
- | Depozita 12 lt
- | Thithja 16 kpa
- | Thithje pluhur dhe uje

Kodi VC14122

CMIMI  
**6.900 Lek**



**ingcco**



### ASPIRATOR ME 3 MOTORA

- | Fuqia 3600 W
- | Depozita 90 lt
- | Ne te thate dhe te lagesht

Kodi WVR5A90

CMIMI  
**24.900 Lek**



**WALFOW**

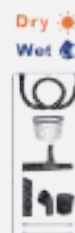

**COPPER WIRE MOTOR**

### ASPIRATOR ME 2 MOTORA

- Fuqia 2400 W
- Depozita 60 lt
- Ne te thate dhe te lagesht



Kodi WVR5A60

CMIMI  
17.900 Lek

### ASPIRATOR

- Fuqia 1200 W
- Depozita 35 lt
- Ne te thate dhe te lagesht



Kodi WVR4A35

CMIMI  
6.900 Lek

### PASTRUESE ME AVULL

- Fuqia: 1200W
- Presioni 4 bar
- Me aksesore

Kodi BVC4300

CMIMI  
24.900 Lek



### ASPIRATOR HIRI

- Fuqia max: 1200W
- Me funksion fryres



Kodi BVC1000

CMIMI  
3.990 Lek



### ASPIRATOR HIRI

- Fuqia max: 1200 W
- Depozite Inoksi 18 Lt

☀️ DRY

Kodi 23.516.61

CMIMI  
4.900 Lek



### FILTER ASPIRATORI HIRI

Kodi 23.516.06

- Depozita 12 L

CMIMI  
3.900 Lek

Kodi 23.516.12

- Depozita 18 L

CMIMI  
2.500 Lek





CVLI20126



**Aspirator makine me bateri**

Fuqja e baterise 20V/1.5 Ah  
Depozita 0.5 Lt

AMPB251



**Fshese rrethore pastrimi**

Per lavazh

AMFB15



**Kove plastike e palosshme**

Per lavazhe 15 Lt

AHPH502



**Zorre presioni**

5m per lavazhe

CVLI2001



**Aspirator makine me bateri**

Vetem trup

AMSG02



**Steke lavazhi e kompletuar**

Me trup plastik

AMFP4002



**Depozite shkume**

Me sprucim  
400 ml

AHPH5028



**Zorre presioni**

Gjatesia 5m

CVLI2026



**Aspirator makine me bateri**

11.1V, depozita 0.5 Lt  
(karikim type-c)

AMSG028



**Steke lavazhi e kompletuar**

Me lidhje te shpejte

AMHB2791



**Furce pastrimi**

Per lavazh

AHPH7511



**Tub pastrimi lavazhi**

150bar/ 7.5m  
per 1400w-2500w

**APB30160**

**incco** **E RE**

Çmimi  
**1.500**

**Furce pastrimi per pishina**

Me 2 bishta te zgjatueshem  
300 mm per lavazhe me bateri

**K7201**

**AR ANNOVI REVERBERI**  
The Power of Experience

Çmimi  
**2.900**

**Steke lavazhi e kompletuar**

90 cm

**KC350A**

**AR ANNOVI REVERBERI**  
The Power of Experience

Çmimi  
**4.900**

**Salvamotor**

Per lavazhe

**50975**

**AR ANNOVI REVERBERI**  
The Power of Experience

**E RE** Çmimi  
**1.750**

**Steke lavazhi model**

Model 388

**Filter per VC24751**

**incco**

Kodi	Te dhena	Çmimi
VC24751-SP-4		<b>1.900</b>
VC24751-SP-95	Rrobe	<b>1.900</b>

**H04**

**AR ANNOVI REVERBERI**  
The Power of Experience

Çmimi  
**6.900**

**Zorre lavazhi Profesionale**

10m, 480 bar me rakorderi  
G3/8 F

**Elektromotorr lavazhi**

**AR ANNOVI REVERBERI**  
The Power of Experience

Kodi	Te dhena	Çmimi
4391	7.5 kW / 10 Hp	<b>65.900</b>
4393	4 kW / 5.5 Hp	<b>39.900</b>

**KL010**

**AR ANNOVI REVERBERI**  
The Power of Experience

**E RE** Çmimi  
**4.500**

**Karroce per lavazh profesional**

Model 2 / Model 5

**Filter per VC24751**

**incco** **HEPA**

Kodi	Te dhena	Çmimi
VC24751-SP-96	Rrjete	<b>350</b>
VCAIHP03	HEPA	<b>1.900</b>

**20080**

**AR ANNOVI REVERBERI**  
The Power of Experience

Çmimi  
**8.900**

**Bypass**

Per grupet RW-RK

**3400260**

**AR ANNOVI REVERBERI**  
The Power of Experience

**E RE** Çmimi  
**2.990**

**Pistolet lavazhi**

Model 590

**41564**

**AR ANNOVI REVERBERI**  
The Power of Experience

**E RE** Çmimi  
**1.290**

**Koke sprucimi**

Per lavazh seria 1

41563

**ERE**Çmimi  
**1.290****Steke sprucimi**

42cm seria 1 dhe 3

41560

**ERE**Çmimi  
**2.200****Tub presioni**

5m Seria 1

46327

**ERE**Çmimi  
**1.290****Koke sprucimi**

Seria 3

46328

**ERE**Çmimi  
**1.990****Pistoletë levazhi**

Seria 3

46332

**ERE**Çmimi  
**1.590****Steke sprucimi**

Seria 3 dhe 4 -5 Twin

46541

**ERE**Çmimi  
**2.690****Tub presioni 6m**

Seria 3

46330

**ERE**Çmimi  
**1.290****Koke sprucimi**

Seria Twin 4.0, 4.1Wi-Touch dhe Twin 5

47048

**ERE**Çmimi  
**1.590****Steke sprucimi**

Seria DTS 4.1 touch

46335

**ERE**Çmimi  
**2.990****Tub presioni**

8m Seria DTS 4.1 dhe 4.0 Twin

46575

**ERE**Çmimi  
**3.590****Pistoletë levazhi**

Seria 5

46576

**ERE**Çmimi  
**2.900****Steke sprucimi**

Seria 5

46581

**ERE**Çmimi  
**9.900****Tub presioni**

10m Seria 5



46844



**E RE**

Çmimi  
**1.690**

**Pistoletë sperkatje shkume**

DHS

46846



**E RE**

Çmimi  
**2.900**

**Zorre spirale sperkatje shkume**

DHS

46845



**E RE**

Çmimi  
**1.790**

**Steke sperkatje shkume**

DHS

3085681



**E RE**

Çmimi  
**4.500**

**Fshese rrethore pastrimi**

25cm Seria 3

**BOMBUL SHKUME**

- | Me tub dhe steke
- | Depozita 50 lt
- | Valvula

Kodi BSH50

CMIMI  
**29.900 Lek**

**E RE**



**BOMBUL SHKUME**

- | Me tub dhe steke
- | Depozita 100 lt
- | Valvula

Kodi K7351

CMIMI  
**34.500 Lek**

**E RE**



**BOMBUL SHKUME**

- | Me tub dhe steke
- | Depozita 25 lt
- | Valvula

Kodi TRG25L2.0

CMIMI  
**19.900 Lek**

**E RE**



**BOMBUL SHKUME**

- | Me tub dhe steke
- | Depozita 50 lt
- | Valvula

Kodi TRG50L2.0

CMIMI  
**24.500 Lek**

**E RE**



A collection of Felco pruning shears and red work gloves is arranged in a wicker basket. The shears have red handles and silver metal heads. One pair of shears prominently displays the 'FELCO' logo and 'SWISS MADE' text on its handle. A red work glove with the 'FELCO' logo is also visible. The basket is filled with greenery, suggesting a gardening or landscaping context.

**GËRSHËRË KRASITJE  
TUBA DHE RAKORDERI**



## GERSHERE KRASITJE ME BATERI

- | Sensori inteligjent i gershereve të mbështetur nga bateria ndihmon me energji shtesë duke e bërë prerjen veçanërisht të lehtë.
- | Dizajn ergonomik për punë me të thjeshtë dhe pa lodhje.
- | Prerje e butë dhe e saktë për të mbrojtur bimët.



### GERSHERE KRASITJE

- | Gershere krasitje me bateri 3.6 V
- | Kapaciteti i prerjes : 25 mm
- | Autonomia 140 min
- | Pesha : 481 gr
- | Lehtëson prerjen me dore deri 5 here me shume

Kodi 12222-20

CMIMI  
15.900 Lek



### GERSHERE KRASITJE

- | Gershere krasitje me bateri
- | Kapaciteti i prerjes : 45 mm
- | Gjatesia : 295 mm
- | Pesha : 980 gr

Kodi EC1300

CMIMI  
14.900 Lek





### GERSHERE KRASITJE

- | Gershere krasitje me bateri 18V
- | Kapaciteti i prerjes : 28 mm
- | Teh BY PASS
- | Pesha : 800 gr
- | Me kapak mbrojtës

Kodi 34.083.00

CMIMI  
8.900 Lek

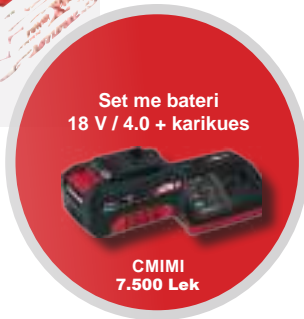

**INGCO**

### GERSHERE DHE SHARRE KRASITJESE ME BATERI MOTOR PA KARBONCINA

- | Tensioni 20 V
- | Me 2 bateri 20V x 2.0 Ah
- | Prerja max 30 mm
- | Karikues i perfshire

Kodi COSLI23065E

CMIMI  
14.500 Lek

**P20S BL MOTOR**



**INGCO**

### GERSHERE KRASITJESE ME BATERI MOTOR PA KARBONCINA

- | Tensioni 20 V
- | Me 1 bateri 20 x 2.0 Ah
- | Prerja max 25 mm
- | Karikues i perfshire

Kodi CSSLI202581

CMIMI  
12.900 Lek



**INGCO**

### GERSHERE KRASITJESE ME BATERI MOTOR PA KARBONCINA

- | Tensioni 20 V
- | Me 1 bateri 20 x 2.0 Ah
- | Prerja max 30 mm
- | Karikues i perfshire

Kodi CSSLI203083

CMIMI  
14.500 Lek





### GERSHERE KRASITJE

- | Gershere krasitje hardhie.
- | Kapaciteti i prerjes : 20 mm
- | Gjatesia : 200 mm
- | Pesha : 175 gr

**Kodi FELCO160S**

**CMIMI  
3.990 Lek**



Kodi	Pershkrimi	Kodi	Pershkrimi
160/9	Bulona	160/9	Bulona
160/6	Set vida	160/6	Set vida
160S/4	Lame	160S/4	Lame
160S/2	Doreze	160S/2	Doreze
160/7	Set vida	160/7	Set vida
160S/3	Lame	160S/3	Lame

### GERSHERE KRASITJE

- | Gershere krasitje hardhie.
- | Kapaciteti i prerjes : 25 mm
- | Gjatesia : 220 mm
- | Pesha : 190 gr

**Kodi FELCO160L**

**CMIMI  
3.990 Lek**



Kodi	Pershkrimi	Kodi	Pershkrimi
160/9	Bulona	160/9	Bulona
160/6	Set vida	160/6	Set vida
160S/4	Lame	160S/4	Lame
160S/2	Doreze	160S/2	Doreze
160/7	Set vida	160/7	Set vida
160S/3	Lame	160S/3	Lame

### GERSHERE KRASITJE

- | Gershere krasitje "Classic model"
- | me ingranazh.
- | Kapaciteti i prerjes : 25 mm
- | Gjatesia : 215 mm
- | Pesha : 240 gr

**Kodi FELCO2**

**CMIMI  
7.500 Lek**



Kodi	Pershkrimi	Kodi	Pershkrimi
160/9	Bulona	160/9	Bulona
160/6	Set vida	160/6	Set vida
160S/4	Lame	160S/4	Lame
160S/2	Doreze	160S/2	Doreze
160/7	Set vida	160/7	Set vida
160S/3	Lame	160S/3	Lame

## GERSHERE KRASITJE

- | Gershere krasitje "Standart model"
- | Kapaciteti i prerjes : 25 mm
- | Gjatesia : 210 mm
- | Pesha : 220 gr

Kodi FELCO4

CMIMI  
5.990 Lek



Kodi	Pershkrimi	Kodi	Pershkrimi
160/9	Bulona	160/9	Bulona
160/6	Set vida	160/6	Set vida
160S/4	Lame	160S/4	Lame
160S/2	Doreze	160S/2	Doreze
160/7	Set vida	160/7	Set vida
160S/3	Lame	160S/3	Lame

## GERSHERE KRASITJE

- | Gershere krasitje "Basic Model"
- | Kapaciteti i prerjes : 25 mm
- | Gjatesia : 225 mm
- | Pesha : 310 gr

Kodi FELCO5

CMIMI  
3.900 Lek

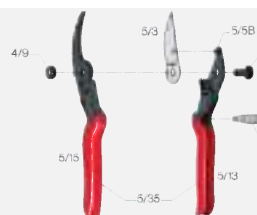

Kodi	Pershkrimi	Kodi	Pershkrimi
4/9	Bulona	5/11	Suste
5/8	Vide lame	5/13	Doreze
5/3	Lame		
5/15	Doreze		
5/5B	Set vida		
5/35	Set 2 doreza		

## GERSHERE KRASITJE

- | Gershere krasitje "Basic Model"
- | Kapaciteti i prerjes : 30 mm
- | Gjatesia : 270 mm
- | Pesha : 310 gr

Kodi FELCO13

CMIMI  
7.900 Lek

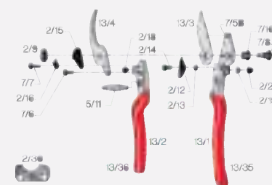

Kodi	Pershkrimi	Kodi	Pershkrimi
2/15	Pjese lame	13/3	Lame
13/4	Maje lame	7/5B	Vide maje
2/9	Bulon	7/10	Bullon
7/7	Vide lame	7/8	Vide+bullon
2/16	Pjese lame	13/16	Doreze
7/6	Vide fundore	13/35	Doreze

## GERSHERE KRASITJE

- | Gershere krasitje "High Performance"
- | me ingranazh.
- | Kapaciteti i prerjes : 25 mm
- | Gjatesia : 210 mm
- | Pesha : 255 gr

Kodi FELCO11

CMIMI  
7.500 Lek



Kodi	Pershkrimi	Kodi	Pershkrimi
2/30	Bashkues	2/5B	Kundralame
2/15	Maje lame	7/5B	Maje lame
11/4	Lame	2/35	Lame
2/18	Vide lame	11/1	Vide lame
2/16	Pjese lame	2/16	Pjese lame
2/12	Pjese lame	2/20	Pjese lame



## GERSHERE KRASITJE

- | Gershere krasitje "Ergonomic Compact"
- | Kapaciteti i prerjes : 20 mm
- | Gjatesia : 195 mm
- | Pesha : 210 gr

Kodi FELCO6

**CMIMI**  
**5.900 Lek**

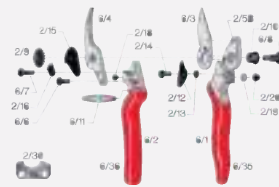

Kodi	Pershkrimi	Kodi	Pershkrimi
6/4	Lame	2/10	Bulon lame
6/3	Lame	6/8	Set vida
6/36	Doreze	2/20	Lame
6/35	Doreze	2/19	Bulon
6/2	Gomine	2/12	Mekanizem
2/5B	Vide lame	2/13	Rondele

## GERSHERE KRASITJE

- | Gershere krasitje "Ergonomic"
- | Kapaciteti i prerjes : 25 mm
- | Gjatesia : 210 mm
- | Pesha : 290 gr

Kodi FELCO7

**CMIMI**  
**8.500 Lek**

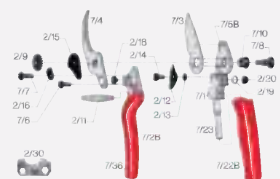

Kodi	Pershkrimi	Kodi	Pershkrimi
7/4	Set vida	7/8	Set vida
7/3	Lame	7/10	Lame
7/5B	Set vida	2/20	Set vida
7/23	Gomine	2/19	Gomine
7/22B	Doreze	2/12	Doreze
7/36	Doreze	2/13	Doreze

## GERSHERE KRASITJE

- | Gershere krasitje "Ergonomic"
- | Kapaciteti i prerjes : 25 mm
- | Gjatesia : 210 mm
- | Pesha : 245 gr

Kodi FELCO8

**CMIMI**  
**6.900 Lek**



Kodi	Pershkrimi	Kodi	Pershkrimi
7/4	Lame	7/8	Set vida
7/3	Kunder lame	7/10	Lame
7/5B	Set vida	7/36	Set vida
2/30	Suport	7/2	Gomine
6/35	Doreze	2/12	Doreze
8/1	Doreze	2/13	Doreze

## GERSHERE KRASITJE

- | Gershere krasitje "Anvil model"
- | me ingranazh.
- | Kapaciteti i prerjes : 25 mm
- | Gjatesia : 210 mm
- | Pesha : 225 gr

Kodi FELCO31

**CMIMI**  
**4.900 Lek**

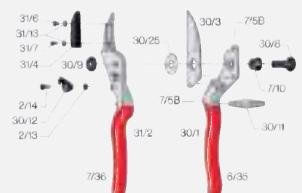

Kodi	Pershkrimi	Kodi	Pershkrimi
30/25	Set vida	30/11	Set vida
30/3	Lame	30/8	Lame
30/9	Set vida	2/14	Set vida
31/4	Gomine	30/12	Gomine
31/2	Doreze	2/13	Doreze
30/1	Doreze	7/5B	Doreze

## GERSHERE KRASITJE

- | Gershere Krasitje me teh By-pass
- | Kapaciteti i prerjes : 20 mm
- | Gjatesia : 210 mm
- | Pesha : 220 gr

**Kodi 10930**

**CMIMI**  
**3.990 Lek**



Kodi	Pershkrimi
KM7199	Set vide dhe suste
KM9064	Vide per dorezen
KM10940	Vide qendrore
KM10943	Lame
KM10944	Kunder lame

## GERSHERE KRASITJE

- | Gershere Krasitje Medium
- | Kapaciteti i prerjes : 20 mm
- | Gjatesia : 210 mm
- | Pesha : 220 gr

**Kodi 4229**

**CMIMI**  
**3.590 Lek**

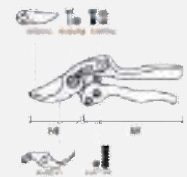

Kodi	Pershkrimi
KM7199	Set vide dhe suste
KM6424	Vide qendrore
KM4228	Lame
KM4230	Kunder lame

## GERSHERE KRASITJE

- | Gershere krasitje alumini me teh SK-5
- | Kapaciteti i prerjes : 25 mm
- | Gjatesia : 210 mm
- | Pesha : 260 gr

**Kodi 9717**

**CMIMI**  
**3.500 Lek**

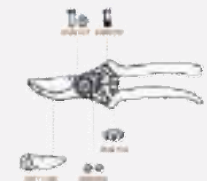

Kodi	Pershkrimi
KM8599	Set vide
KM6128	Suste
KM6127	Vide qendrore
KM6908	Fermo
KM11202	Lama

## GERSHERE KRASITJE

- | Gershere krasitje alumini me teh SK-5
- | Kapaciteti i prerjes : 25 mm
- | Gjatesia : 210 mm
- | Pesha : 250 gr

**Kodi 6067**

**CMIMI**  
**3.790 Lek**



Kodi	Pershkrimi
KM8599	Set vide
KM6128	Suste
KM6127	Vide qendrore
KM6908	Fermo
KM11202	Lama

### GERSHERE KRASITJE

- | Gershere krasitje alumini me teh inoxi KM-12
- | Kapaciteti i prerjes : 20 mm
- | Gjatesia : 200 mm
- | Pesha : 205 gr

**Kodi 6069**

**CMIMI**  
**1.990 Lek**



### GERSHERE KRASITJE

- | Gershere Krasitje me teh By-pass KM-1
- | Kapaciteti i prerjes : 25 mm
- | Gjatesia : 210 mm
- | Pesha : 260 gr

**Kodi 13803P**

**CMIMI**  
**3.900 Lek**



### GERSHERE KRASITJE

- | Gershere krasitese me teh inoxi me hark
- | Ideale per vjelje
- | Gjatesia : 170 mm
- | Pesha : 120 gr

**Kodi 1097**

**CMIMI**  
**990 Lek**



### GERSHERE KRASITJE

- | Gershere krasitese me teh inoxi te drejte
- | Ideale per vjelje
- | Gjatesia : 190 mm
- | Pesha : 140 gr

**Kodi 1104**

**CMIMI**  
**990 Lek**





1  
2  
3  
4  
5  
6  
7  
8  
9  
10



### GERSHERE KRASITJE

- | Kapaciteti i prerjes 18 mm
- | Për prerjen e kercejve të thatë

Kodi 8754-20

MADE IN GERMANY

CMIMI  
1.700 Lek



### GERSHERE KRASITJE

- | Kapaciteti i prerjes 20 mm
- | Për prerjen e kercejve të njomë

Kodi 8854-20

MADE IN GERMANY

CMIMI  
1.990 Lek

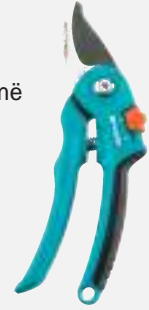

### GERSHERE KRASITJE

- | Kapaciteti i prerjes 18 mm
- | Për prerjen e kercejve të njomë

Kodi 8855-20

MADE IN GERMANY

CMIMI  
2.100 Lek



### GERSHERE KRASITJE

- | Kapaciteti i prerjes 22 mm
- | Për prerjen e luleve, fidanëve dhe kercejve te njome

Kodi 8857-20

MADE IN GERMANY

CMIMI  
2.200 Lek



### GERSHERE KRASITJE

- | Kapaciteti i prerjes 23 mm
- | Për prerjen e degëve te vjetra, të trasha dhe të thata

Kodi 8903-20

MADE IN GERMANY

CMIMI  
2.900 Lek



### GERSHERE KRASITJE

- | Kapaciteti i prerjes 24 mm
- | Për prerjen e luleve, fidanëve dhe dru të freskët

Kodi 8904-20

MADE IN GERMANY

CMIMI  
2.900 Lek



### GERSHERE KRASITJE

- | Kapaciteti i prerjes 24 mm
- | Për prerjen e degëve të njoma

Kodi 8905-20

MADE IN GERMANY

CMIMI  
3.900 Lek



### GERSHERE KRASITJE

- | Kapaciteti i prerjes 24 mm
- | Për prerjen e luleve, fidanëve dhe dru të freskët

Kodi 8906-20

MADE IN GERMANY

CMIMI  
4.500 Lek





### GERSHERE KRASITJE

- ▮ Kapaciteti i prerjes 22 mm
- ▮ Për prerjen e luleve, fidanëve dhe dru të freskët

Kodi 8702-20

MADE IN GERMANY



CMIMI  
5.900 Lek



### GERSHERE KRASITJE

- ▮ Kapaciteti i prerjes 22 mm
- ▮ Për prerjen e degëve të trasha dhe të thata

Kodi 8798-20

MADE IN GERMANY



CMIMI  
6.300 Lek



### GERSHERE KRASITJE

- ▮ Kapaciteti i prerjes 16 mm
- ▮ Teh me sipërfaqe që nuk ngjit
- ▮ Për prerjen e degëve dhe fidaneve të lagura

Kodi 40-414

CMIMI  
1.400 Lek



### GERSHERE KRASITJEJE

- ▮ GERSHERE krasitje me bypass
- ▮ Teh me sipërfaqe që nuk ngjit
- ▮ Me bypass 10-18 mm

Kodi 41-020

CMIMI  
1.950 Lek



### GERSHERE KRASITJE

- ▮ GERSHERE krasitje metalike
- ▮ Teh çeliku i fortë, i kromuar
- ▮ Me bypass 22 mm

Kodi 40-417

CMIMI  
2.450 Lek



### GERSHERE KRASITJEJE

- ▮ GERSHERE krasitje metalike Anvil
- ▮ Teh çeliku i fortë, i kromuar
- ▮ Me bypass 22 mm

Kodi 40-418

CMIMI  
2.900 Lek





**GERSHERE KRASITJE**

- | Kapaciteti i prerjes 12 mm
- | Gjatesia 200 mm

**Kodi HPS0109**

**CMIMI  
550 Lek**



**GERSHERE KRASITJE**

- | Kapaciteti i prerjes 12 mm
- | Gjatesia 200 mm

**Kodi HPS0201**

**CMIMI  
490 Lek**



**GERSHERE KRASITJE**

- | Kapaciteti i prerjes 16 mm
- | Gjatesia 220 mm

**Kodi HPS0601**

**CMIMI  
690 Lek**



**GERSHERE KRASITJE**

- | Kapaciteti i prerjes 16 mm
- | Gjatesia 200 mm

**Kodi HPS0308**

**CMIMI  
890 Lek**



**GERSHERE KRASITJE**

- | Gjatesia 200 mm
- | Kapaciteti i prerjes 15 mm

**Kodi 99230**

**CMIMI  
490 Lek**



**GERSHERE KRASITJE  
UNIVERSALE**

- | Gjatesia 205 mm
- | Kapaciteti i prerjes 20 mm

**Kodi 99204**

**CMIMI  
550 Lek**





**WOLF**  
**GERSHERE KRASITJE**

- | Permasa 200 mm
- | 8"

**Kodi WPA1E08**

**CMIMI**  
**390 Lek**



**GERSHERE MULTIFUNKSIONALE**

- | Gjatesia 210 mm
- | Për prerjen e erzave, luleve te vogla etj

**Kodi 8705-20**

**CMIMI**  
**2.900 Lek**

**MADE IN GERMANY**



**FIO**  
**GERSHERE LULESH**

- | Gjatesia 165 mm
- | Me teh te drejte

**Kodi 99182**

**CMIMI**  
**150 Lek**



**FIO**  
**GERSHERE LULESH**

- | Gjatesia 170 mm
- | Me teh te rumbullaket

**Kodi 99180**

**CMIMI**  
**190 Lek**



**FIO**  
**GERSHERE RRUSHI DHE LULESH**

- | Gjatesia 190 mm
- | Me teh SK5

**Kodi 99240**

**CMIMI**  
**450 Lek**



**FELCO**  
**SHKOP TELESKOPIK**

- | Shkop teleskopik per Gersher krasitje
- | Materiali Alumin
- | Gjatesia : 150-350 cm
- | Pesha: 1.4 kg

**Kodi 880/100-150**

**CMIMI**  
**29.000 Lek**



**FELCO**  
**SET MIREMBAJTJE**

- | Per gershere krasitje
- | Felco 812

**Kodi 812/916**

**CMIMI**  
**7.500 Lek**



**FELCO**  
**SET MIREMBAJTJE**

- | Per gershere krasitje
- | Felco 822

**Kodi 822/916**

**CMIMI**  
**7.900 Lek**



### XHEP LEKURE

- Per mbajtjen e gershereve
- Felco



Kodi FELCO932

CMIMI  
1.500 Lek



### GERSHERE BARI



- Gjatesia 180 mm
- Tehu i galvanizuar

MADE IN GERMANY 



Kodi 8730-30

CMIMI  
2.490 Lek



### GERSHERE BARI ME KOKE TE RROTULLUESHME



- Gjatesia 180 mm
- Kendi 360°

MADE IN GERMANY 



Kodi 8731-30

CMIMI  
2.790 Lek



### GERSHERE BARI ME BISHT



- Rrota levizese
- Kendi 90°

MADE IN GERMANY 



Kodi 12100-20

CMIMI  
4.990 Lek



### GERSHERE BARI



- Kendi 340°
- Gjatesia 180 mm

340mm (13-1/4")

340°

Kodi HPS3401

CMIMI  
790 Lek



### GERSHERE BARI



- Kokë e rrumbullakët
- Tehu: 13 cm
- Për prerjen e skajeve të lëndinave

Kodi 40-405

CMIMI  
1.990 Lek



### GERSHERE BARI



- Gjatesia 300 mm
- Materiali: Celik Karboni

Kodi 99301

CMIMI  
590 Lek



### GERSHERE KRASITJE

- | Kapaciteti i prerjes 45 mm
- | Gjatesia 840 mm

Kodi FELCO22

CMIMI  
19.500 Lek



### GERSHERE KRASITJE

- | Kapaciteti i prerjes 25 mm
- | Gjatesia 210 mm

Kodi FELCO211-60

CMIMI  
9.900 Lek



### GERSHERE KRASITJE

- | Kapaciteti i prerjes 32 mm
- | Gjatesia 600 mm

Kodi 6577

CMIMI  
3.900 Lek



### GERSHERE KRASITJE

- | Kapaciteti i prerjes 42 mm
- | Gjatesia totale 500 mm

Kodi 12002-20

CMIMI  
4.990 Lek

MADE IN GERMANY



### GERSHERE KRASITJE

- | Kapaciteti i prerjes 42 mm
- | Gjatesia totale 680 mm

Kodi 12003-20

CMIMI  
5.900 Lek

MADE IN GERMANY



### GERSHERE KRASITJE TELESKOPIKE

- | Kapaciteti i prerjes 42 mm
- | Gjatesia totale 520-670 mm

Kodi 12005-20

CMIMI  
6.900 Lek

MADE IN GERMANY



### GERSHERE KRASITJE ME INGRANAZH

- | Kapaciteti i prerjes 42 mm
- | Gjatesia totale 600 mm

Kodi 12006-20

CMIMI  
7.900 Lek

MADE IN GERMANY



### GERSHERE KRASITJE TELESKOPIKE

- | Kapaciteti i prerjes 42 mm
- | Gjatesia totale 650-900 mm

Kodi 12009-20

CMIMI  
8.900 Lek

MADE IN GERMANY





### GERSHERE KRASITJE ME INGRANAZH

- | Kapaciteti i prerjes 42 mm
- | Gjatesia totale 750 mm

Kodi 12008-20

CMIMI  
9.500 Lek

MADE IN  
GERMANY



GARDENA



### GERSHERE KRASITJE

- | GERSHERE degësh alumini
- | Teh me sipërfaqe që nuk ngjit
- | Me bypass 45 mm

Kodi 40-411

CMIMI  
5.900 Lek

cellfast



### GERSHERE KRASITJE

- | Gershere degësh alumini teleskopike
- | Kapaciteti i prerjes: 700-1010 mm
- | Me bypass 45 mm

Kodi 40-410

CMIMI  
6.990 Lek

cellfast



### GERSHERE KRASITJE

- | Gershere degësh me Anvil
- | Teh me sipërfaqe që nuk ngjit
- | Gjatesia totale 690 mm

Kodi 99112

CMIMI  
990 Lek

FLO



### GERSHERE KRASITJE

- | Gershere degësh me Anvil
- | Me bypass: 30 mm
- | Gjatesia totale 660 mm

Kodi 99109

CMIMI  
1.450 Lek

FLO



### GERSHERE KRASITJE

- | Gershere krasitje
- | Me bypass: 45 mm
- | Gjatesia totale 700 mm

Kodi 99111

CMIMI  
1.690 Lek

FLO



### GERSHERE KRASITJE

- | Kapaciteti i prerjes 23 mm
- | Gjatesia 725 mm

Kodi HLT7101

CMIMI  
1.250 Lek

INGCO



### GERSHERE KRASITJE

- | Kapaciteti i prerjes 40 mm
- | Gjatesia 760 mm

Kodi HLT7608

CMIMI  
1.990 Lek

INGCO



**INGCCO**

**GERSHERE KRASITJE**

- | Kapaciteti i prerjes 25 mm
- | Gjatesia totale 760 mm

Kodi HLT7401

**CMIMI**  
**1.690Lek**



**INGCCO**

**GERSHERE KRASITJE**

- | Kapaciteti i prerjes 27 mm
- | Gjatesia 690 mm

Kodi HLT72011

**CMIMI**  
**990 Lek**



**INGCCO**

**GERSHERE KRASITJE  
TELESKOPIKE**

- | Kapaciteti i prerjes 25 mm
- | Gjatesia 660-860 mm

Kodi HLTS7401

**CMIMI**  
**1.950 Lek**



**INGCCO**

**GERSHERE KRASITJE  
TELESKOPIKE**

- | Kapaciteti i prerjes 40 mm
- | Gjatesia 650-850 mm

Kodi HLTS7608

**CMIMI**  
**1.990 Lek**



**WADFOW**

**GERSHERE KRASITJE**

- | Kapaciteti i prerjes 18 mm
- | Gjatesia 690 mm

Kodi WPR1301

**CMIMI**  
**890 Lek**



**INGCCO**

**SET ME 3 GERSHERE**

- | Gershere krasitje dore 8.5"
- | Gershere ligustrash 23"
- | Gershere krasitje 29"

Kodi HLT76033

**CMIMI**  
**2.500 Lek**



1  
2  
3  
4  
5  
6  
7  
8  
9  
10



### GERSHERE LIGUSTRASH

- | Gjatesia totale 535 mm
- | Gjatesia tehut 230 mm

Kodi 12300-20



**CMIMI**  
**3.950 Lek**



### GERSHERE LIGUSTRASH

- | Gjatesia totale 407 mm
- | Gjatesia tehut 180 mm

Kodi 12302-20



**CMIMI**  
**3.900 Lek**



### GERSHERE LIGUSTRASH

- | Gjatesia totale 537 mm
- | Gjatesia tehut 200 mm

Kodi 12301-20



**CMIMI**  
**5.900 Lek**



### GERSHERE LIGUSTRASH TELESKOPIKE

- | Gjatesia totale 700-900 mm
- | Gjatesia tehut 230 mm

Kodi 12304-20



**CMIMI**  
**6.900 Lek**



### GERSHERE LIGUSTRASH ME INGRANAZH

- | Gjatesia totale 600 mm
- | Gjatesia tehut 230 mm

Kodi 12303-20



**CMIMI**  
**6.900 Lek**



### GERSHERE LIGUSTRASH

- | Gjatesia totale 50 mm
- | Gjatesia tehut 250 mm

Kodi 395-20



**CMIMI**  
**7.900 Lek**



### GERSHERE LIGUSTRASH

- | Materiali Alumin
- | Gjatesia 400 mm

Kodi 8842

**CMIMI**  
**5.800 Lek**



### GERSHERE LIGUSTRASH ME INGRANAZH

- | Gershere ligustrash alumini
- | Tehu: 20 cm IDEAL
- | Për prerjen e shkurreve, pemëve të vogla dhe gardheve

Kodi 40-401

**CMIMI**  
**4.500 Lek**







### GERSHERE LIGUSTRASH ME INGRANAZH TELESKOPIKE

- | Gershère ligustrash alumini teleskopike
- | Tehu: 20 cm IDEAL
- | Për prerjen e shkurreve, pemëve të vogla dhe gardheve

**Kodi 40-400**  
**CMIMI**  
**5.500 Lek**



### GERSHERE LIGUSTRASH

- | Gershère ligustrash 550 mm
- | Tehu: 24 cm
- | Për prerjen e shkurreve, pemëve të vogla dhe gardheve

**Kodi 99005**  
**CMIMI**  
**990 Lek**



### GERSHERE LIGUSTRASH

- | Kapaciteti i prerjes 10 mm
- | Gjatesia 557 mm

**Kodi HHS6001**  
**CMIMI**  
**1.350 Lek**



### GERSHERE LIGUSTRASH

- | Kapaciteti i prerjes 10 mm
- | Gjatesia 557 mm

**Kodi HHS6301**  
**CMIMI**  
**1.250 Lek**



### GERSHERE LIGUSTRASH TELESKOPIKE

- | Kapaciteti i prerjes 10 mm
- | Gjatesia 710-860 mm

**Kodi HHS6306**  
**CMIMI**  
**1.690 Lek**



### GERSHERE LIGUSTRASH

- | Kapaciteti i prerjes 10 mm
- | Gjatesia 550 mm

**Kodi HHS62011**  
**CMIMI**  
**990 Lek**



### GERSHERE LIGUSTRASH

- | Kapaciteti i prerjes 10 mm
- | Gjatesia 550 mm

**Kodi WPR2301**  
**CMIMI**  
**890 Lek**



### SET ME 3 GERSHERE

- | Gershère krasitje dore 8"
- | Gershère ligustrash 22"
- | Gershère krasitje 27"

**Kodi HLT78033**  
**CMIMI**  
**1.990 Lek**



**E RE**

### SHARRE KRASITJE

- | SHARRE KRASITJE ME PALOSJE
- | Kapaciteti i prerjes: 60 mm
- | Gjatesia e tehut: 120 mm

Kodi Felco-601

**CMIMI  
2.890 Lek**



**E RE**

### SHARRE KRASITJE

- | SHARRE KRASITJE ME PALOSJE
- | Kapaciteti i prerjes: 80 mm
- | Gjatesia e tehut: 160 mm

Kodi Felco-602

**CMIMI  
2.990 Lek**



### SHARRE KRASITJE

- | Sharre krasitese me lama te drejta
- | Kapaciteti i prerjes : 100 mm
- | Gjatesia : 500 mm
- | Pesha : 370 gr

Kodi FELCO611

**CMIMI  
5.900 Lek**



### SHARRE KRASITJE

- | Sharre krasitese me lama te harkuar
- | Kapaciteti i prerjes : 120 mm
- | Gjatesia : 496 mm
- | Pesha : 400 gr

Kodi FELCO630

**CMIMI  
6.900 Lek**



### SHARRE KRASITJE

- | Sharre krasitese me lama te harkuar
- | Kapaciteti i prerjes : 100 mm
- | Gjatesia : 437 mm
- | Pesha : 365 gr

Kodi FELCO640

**CMIMI  
4.900 Lek**



### SHARRE KRASITJE

- | Sharre dore e drejte
- | Kapaciteti i prerjes : 60 mm
- | Gjatesia : 240 mm

Kodi 2970

**CMIMI  
2.990 Lek**



### SHARRE KRASITJE

- | Sharre dore e drejte
- | Kapaciteti i prerjes : 80 mm
- | Gjatesia : 300 mm

Kodi 2977

**CMIMI**  
**3.500 Lek**



### SHARRE KRASITJE

- | Sharre dore me hark
- | Kapaciteti i prerjes : 80 mm
- | Gjatesia : 330 mm

Kodi 2981

**CMIMI**  
**3.500 Lek**



### SHARRE KRASITJE

- | Sharre e palosshme krasitje e drejte
- | Kapaciteti i prerjes : 50 mm
- | Gjatesia : 180 mm

Kodi 8967

**CMIMI**  
**2.490 Lek**



### SHARRE KRASITJE

- | Sharre dore me hark dhe bisht teleskopik
- | Kapaciteti i prerjes : 80 mm
- | Lartesia : 300 mm

Kodi 8509

**CMIMI**  
**7.900 Lek**



### SHARRE ME BISHT TELESKOPIK

- | Sharre krasitese me hark dhe bisht teleskopik
- | Kapaciteti i prerjes : 50 mm
- | Gjatesia : 6 m

Kodi 9249

**CMIMI**  
**9.900 Lek**

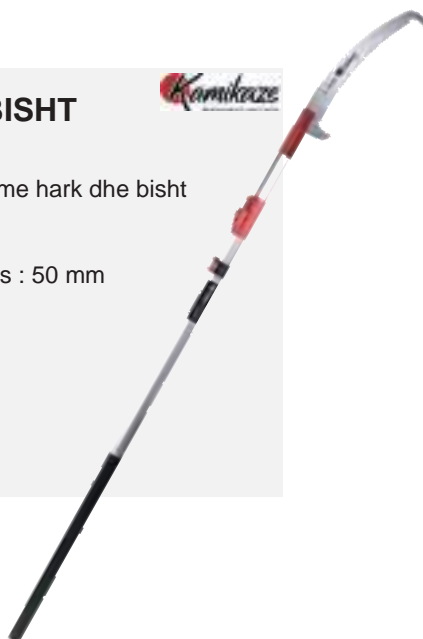

### SHARRE TELESKOPIKE

- | Sharre krasitese me hark dhe bisht teleskopik
- | Kapaciteti i prerjes : 50 mm
- | Gjatesia : 280 cm

Kodi HEPS25281

**CMIMI**  
**2.500 Lek**



MAXp  
25mm

Extend: 2800mm

Extend: 2400mm

Extend: 1200mm

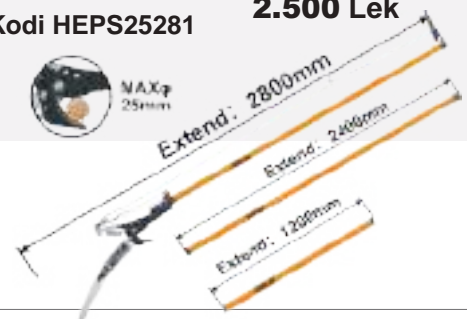



### SHARRE KRASITJE



- | Sharre Krasitese me palosje
- | Gjatesia : 135 mm
- | Dhëmbë preçiz me mprehje të 3-fishtë.  
Dorezë me gominë

Kodi 8742-20

**CMIMI**  
**3.990 Lek**



### SHARRE KRASITJE



- | Sharre Krasitese me palosje
- | Gjatesia : 200 mm
- | Dhëmbë preçiz me mprehje të 3-fishtë.  
Dorezë me gominë

Kodi 8743-20

**CMIMI**  
**5.500 Lek**



### SHARRE KRASITJE



- | Sharre krasitese
- | Gjatesia : 400 mm
- | Dhëmbë preçiz me mprehje të 3-fishtë.  
Dorezë me gominë

Kodi 8745-20

**CMIMI**  
**5.500 Lek**



### SHARRE KRASITJE



- | Sharre krasitje CombiSystem
- | Gjatesia : 325 mm
- | Kombinohet me bishtat teleskopikë.  
Teh i kromuar

Kodi 8737-20

**CMIMI**  
**3.690 Lek**



### SHARRË KRASITËSE E DREJTË



- | Gjatësia : 300 mm

Kodi 41-040

**CMIMI**  
**2.650 Lek**



### SHARRË KRASITËSE E PALOSSHME



- | Gjatësia : 250 mm

Kodi 41-041

**CMIMI**  
**2.950 Lek**





**SHARRE KRASITËSE DRURI**

| Gjatesia : 250 mm

Kodi 28640 **CMIMI 390 Lek**



**SHARRE KRASITËSE E PALOSSHME**

| Gjatesia : 180 mm

Kodi 28641 **CMIMI 490 Lek**



**SHARRE KRASITJE**

- | Sharre krasitje e palosshme
- | Tehu : 65 mn
- | Gjatesia : 180 mm

**180mm(7)**

Kodi HFSW18028C

**CMIMI 490 Lek**



**SHARRE KRASITJE**

- | Sharre krasitje e palosshme
- | Tehu : 65 mn
- | Gjatesia : 180 mm

**180mm(7)**

Kodi HFSW1808

**CMIMI 690 Lek**

**TAIWAN**



**SHARRE KRASITJE**



- | Sharre krasitje e harkuar
- | Tehu : 65 mn
- | Gjatesia : 330 mm

Kodi HPS33028C

**CMIMI 590 Lek**



**SHARRE KRASITJE**



- | Sharre dore e drejte
- | Tehu : 65 mn
- | Gjatesia : 300 mm

Kodi HPS30028C

**CMIMI 590 Lek**



**SHARRE KRASITJE**



- | Sharre dore e drejte
- | Tehu : 65 mn
- | Gjatesia : 300 mm

Kodi HPS3008

**CMIMI 890 Lek**



**SHARRE KRASITJE**



- | Sharre dore me hark
- | Tehu : 65 mn
- | Gjatesia : 330 mm

Kodi HPS3308

**CMIMI 890 Lek**

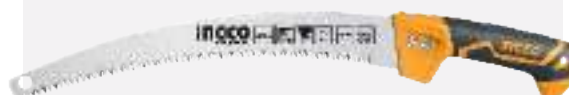

### SHARRE KRASITJE



- | Sharre dore palosshme
- | Tehu : 65 mn
- | Gjatesia : 180 mm

Kodi WHW4607

CMIMI  
450 Lek



### SHARRE KRASITJE



- | Sharre dore e drejte
- | Tehu : 65 mn
- | Gjatesia : 270 mm

Kodi WHW5G12

CMIMI  
490 Lek



### SHARRE KRASITJE



- | Sharre dore me hark
- | Tehu : 65 mn
- | Gjatesia : 300 mm

Kodi WHW7G12

CMIMI  
490 Lek



### SHARRË DORE ME HARK

- | Sharre dore me hark për dru
- | Gjatesia : 760 mm

Kodi 8748-20

CMIMI  
3.900 Lek



### SHARRË DORE ME HARK

- | Sharre dore me hark për dru
- | Gjatesia : 610 mm

Kodi 40-421

CMIMI  
1.990 Lek



### SHARRË DORE ME HARK

- | Sharre dore me hark për dru
- | Gjatesia : 533 mm

Kodi 40-420

CMIMI  
1.890 Lek





**SOPATË UNIVERSALE**

- | Pesha 1100 g
- | Gjatesia 450 mm

Kodi 41-002

**CMIMI**  
**5.500 Lek**



**SOPATË UNIVERSALE**

- | Pesha 1600 g
- | Gjatesia 615 mm

Kodi 41-003

**CMIMI**  
**6.500 Lek**



**SOPATË UNIVERSALE**

- | Pesha 1200 g
- | Gjatesia 450 mm

Kodi 41-004

**CMIMI**  
**6.500 Lek**



**SOPATË UNIVERSALE**

- | Pesha 1600 g
- | Gjatesia 615 mm

Kodi 41-005

**CMIMI**  
**6.500 Lek**



**SOPATË UNIVERSALE**

- | Pesha 2000 g
- | Gjatesia 740 mm

Kodi 41-006

**CMIMI**  
**7.500 Lek**



**SOPATË UNIVERSALE**

- | Pesha 2500 g
- | Gjatesia 740 mm

Kodi 41-007

**CMIMI**  
**7.500 Lek**



**SOPATE UNIVERSALE**

- | Pesha 600 gr
- | Gjatesia 390 mm

Kodi HAX02010008

**CMIMI**  
**990 Lek**



**SOPATE UNIVERSALE**

- | Pesha 1000 gr
- | Gjatesia 430 mm

Kodi HAX02060008

**CMIMI**  
**1.350 Lek**



**INGCO**
**SOPATE UNIVERSALE**

- | Pesha 1250 gr
- | Gjatesia 700 mm

**Kodi HAX02012508**
**CMIMI  
1.990 Lek**

**LOPATE E DREJTE "IDEAL"**

- | Gjatesia e bishtit: 1195 mm
- | Materiali celik

**Kodi 40-201**
**CMIMI  
2.900 Lek**

**LOPATE "IDEAL"**

- | Gjatesia e bishtit: 1160 mm
- | Me bisht fibre

**Kodi 40-202**
**CMIMI  
2.900 Lek**

**LOPATE ME MAJE**

- | Gjatesia totale 1170 mm
- | Me bisht alumini

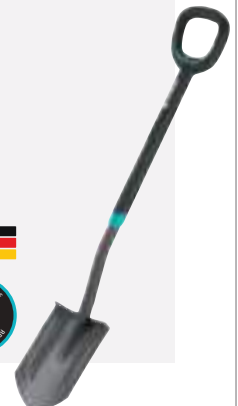
**Kodi 17010-20**
**CMIMI  
5.900 Lek**
**MADE IN  
GERMANY**
**25**  
YEARS WARRANTY

**LOPATE METALIKE**

- | Gjatesia e bishtit: 1200mm
- | Me bisht fibre

**Kodi 35835**
**CMIMI  
1.500 Lek**

**LOPATE DHE KAZME**

- | Metalike me palosje  
12x46.5cm

**Kodi 40-007**
**CMIMI  
1.450 Lek**

**SFURK METALIK "IDEAL"**

- | Gjatesia e bishtit: 1280mm
- | Me bisht fibre

**Kodi 40-221**
**CMIMI  
3.500 Lek**

**SFURK METALIK**

- | Gjatesia e bishtit: 1200mm
- | Me bisht fibre

**Kodi 35892**
**CMIMI  
1.590 Lek**

**INGCO**

**PRASHITES TOKE**

- | Permasa 290x75x8 mm
- | Materiali celik

Kodi HGT979K

**CMIMI**  
**350 Lek**



**INGCO**

**SFURK I VOGEL**

- | Permasa 320 mm
- | Materiali celik

Kodi HFTF38

**CMIMI**  
**250 Lek**



**INGCO**

**KREHER KOPSHTI**

- | Permasa 290x75x8 mm
- | Materiali celik

Kodi HFTR1008

**CMIMI**  
**350 Lek**



**INGCO**

**LOPATE KOPSHTI**

- | Permasa 340 mm
- | Materiali celik

Kodi HFTT858

**CMIMI**  
**350 Lek**



**FLO**

**KREHER METALIK**

- | Me koke te rregullueshme
- | Pa bisht

Kodi 99401

**CMIMI**  
**350 Lek**



**GARDENA**

**KREHER GJETHESH**

- | Per ti mbledhur
- | Me rregullim

Kodi 3103-20

**CMIMI**  
**2.990 Lek**



**FLO**

**MBJELLES FIDANESH**

- | Mbajtese doreze plastike
- | Materiali celik
- | Pesha 0.275 kg

Kodi 99033

**CMIMI**  
**290 Lek**



**cellfast**

**MBJELLES FIDANESH**

- | Mbajtese doreze plastike
- | Materiali celik
- | 182x243x134 mm

Kodi 42-261

**CMIMI**  
**750 Lek**





### LOPATE KOPSHTI

- | Lopate Kopshti
- | E zeze

Kodi 42-031

CMIMI  
490 Lek



### SET ME 3 VEGLA KOPSHTARIE

- | Vegla kopshtarie
- | 3 cope

Kodi 40-058

CMIMI  
990 Lek



### PRASHITES KOPSHTI

- | 308 x 197 x 85 cm
- | Materiali Plastik

Kodi 42-037

CMIMI  
590 Lek



### LOPATE KOPSHTI

- | Permasa 330 mm
- | Materiali celik

Kodi 99034

CMIMI  
290 Lek



### SET ME 3 VEGLA KOPSHTARIE

- | Bisht druri
- | Materiali celik

Kodi 99028

CMIMI  
450 Lek



### KREHER KOPSHTI

- | Permasa 330 mm
- | Me 5 tehe

Kodi 99036

CMIMI  
290 Lek



### LOPATE E PALOSSHME

- | Permasa 410 mm
- | Materiali celik

Kodi 99054

CMIMI  
990 Lek



### PRASHITES KOPSHTI

- | Permasa 300 mm
- | Materiali celik

Kodi 99037

CMIMI  
350 Lek



**FC-8101**

Çmimi

**1.500**
**Lidhese rrushi / perimesh jeshile me rrip plastik**

Ngjyra

Jeshile

**FC-8104**

Përdorimi i gjerë: Ky mjet profesional për lidhësin e makinerisë së bimëve mund të përdoret për lloje të ndryshme bimësh, si rrush, domate, tranguj, specia, lule, etj.



Çmimi

**1.600**
**Lidhese rrushi / perimesh me thike + suste rezerve**

Ngjyra

Portokalli

**FC-8106**

Lidhesja e rrushit dhe perimeve FC-8106 është prej çeliku me cilësi të lartë, e qëndrueshme dhe e lehtë për t'u mbajtur dhe për t'u përdorur. Kjo lidhëse mund të përdoret me shirit 60 metra, e përkryer për lidhjen e të gjitha hardhive.



Çmimi

**1.700**
**Lidhese rrushi / perimesh me rrip plastik Profi.**

Ngjyra

Portokalli

**FC-8102**

Çmimi

**1.500**
**Lidhese rrushi / perimesh e verdhe me rrip plastik**

Ngjyra

Mikse

**FC-8105**

Fidanishtet, kultivuesit e pemëve, vreshtat dhe pemishtet të gjithë përjetojnë potencialin e kursimit të kohës me lidhësen e rrushit dhe perimeve.



Çmimi

**1.600**
**Lidhese rrushi / perimesh e kuqe**

Ngjyra

E kuqe

**FC-8107**

Lidhesja e rrushit dhe perimeve FC-8107 është e pajisur me një trup unik, të qëndrueshëm dhe rezistent ndaj ndryshkut, i cili përmirëson shumë efikasitetin tuaj të punës, kursen kostot e punës dhe kursen kohë. Kjo makineri shërben për lidhjen e rrushit, domateve e shumë perimeve të tjera në kopshtin tuaj.



Çmimi

**1.700**
**Lidhese rrushi / perimesh e zeze Profi Line**

Ngjyra

E kuqe

FC-8201



Çmimi  
**850**

Gershëre për shartese

Paketimi 1 cope

FC-8202



Çmimi  
**1.350**

Gershëre shartimi set

Paketimi valixhe

FC-8231



Çmimi  
**1.900**

Gershëre për shartese metalike

Materiali Inox

99250



Çmimi  
**1.350**

Gershëre shartimi dhe krasitje 2 në 1

Paketimi 1 cope

40-260



Çmimi  
**990**

Thikë shartimi me teh celiku

Permasa 17 cm

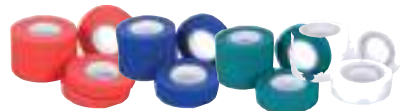

Shirit për lidhjen e bimeve

Kodi	Ngjyra	Cmimi
FC-8801-1	E kuqe	45
FC-8801-2	Blu	45
FC-8801-3	Jeshile	45
FC-8801-4	E bardhe	45

FC-8901



Çmimi  
**150**

Kapese metalike për lidhese rrushi

Permasa 6 mm x 4 mm

FC-8281



Çmimi  
**90**

Shirit për shartimin e bimeve

Permasa 3 cm x 100 m

FC-8251

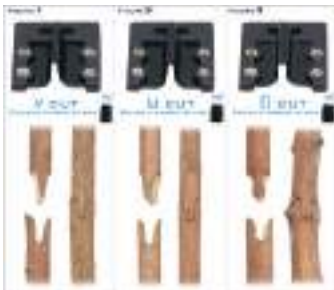

Çmimi  
**150**

Thikë gershëre shartimi

Seti 3 cope

FC-8831



FC-8908



Thikë rezerve

Kodi	Paketimi	Cmimi
FC-8831	1 cope	590
FC-8908	1 cope	100

88806



Çmimi  
**190**

Tel për lidhje rrushi

Mbrojtëse plastike 50 m



# Karroca uji GARDENA

Karrocat e dhura te ujit per cdo permase kopshti

Gama jone e gjere dhe e mirestrukturuar e produkteve e ben zgjedhjen tuaj me te thjeshte.

Per me teper, te gjitha karrocet tona CleverRoll jane kunder ngrices.

Cilesi Gjermane per jetegjatesi me te larte.

**MADE IN GERMANY**



Seria CleverRoll

**S**



**CleverRoll S** - per kopshte te vogla

- Max 40 m zorre 13 mm (1/2")
- Model kompakt me lartesi doreze te ndryshueshme

**M**



**CleverRoll M** - per kopshte me madhesi mesatare

- Max. 60 m zorre 13 mm (1/2")
- Stabilitet maksimal fale sistemit Kick&Stand
- Gjithashtu edhe ne versionin me skelet metalik

**L**



**CleverRoll L Easy** - per kopshte te medha

- Max 100 m zorre 13 mm (1/2")
- Stabilitet maksimal fale sistemit Kick&Stand
- Me guide metalike te zorres per rrotullim preciz
- Gjithashtu dhe ne versionin metalik



**Magazinim kompakt**

Thjesht leshoni leven pershtasni lartesine dhe me pas mbylleni leven serisht



**Rrotullim perfekt**

Ergonomike, rehatshme, e thjeshte ne rrotullim. Palosje e shpejte per te ruajtur hapesine magazinimi



**Stabilitet i larte fale sistemit Kick&Stand**

Fale kembezes se jashtme mbeshtetese karroca nuk do te rrezohet. Forma e saj speciale plus rrotat me te medhaja sigurojne suport shtese per karrocen e zorres se ujit. Thjeshte palosni kembezen mbeshtetese kur deshironi ta magazinoni.



# TUBA UJI & RAKORDERI



**KARROCE UJI ME RAKORDERI**

- | Diametri 1/2"
- | Gjatesia 15 m

MADE IN GERMANY

Kodi 2687-20

CMIMI  
**6.900 Lek**



**KARROCE UJI AQUAROLL S**

- | Diametri 1/2"
- | Gjatesia 20 m

MADE IN GERMANY

Kodi 18502-20

CMIMI  
**8.500 Lek**



**KARROCE ME ZORRE UJI ME RAKORDERI**

- | Diametri 1/2"
- | Gjatesia 20 m

MADE IN GERMANY

Kodi 2691-20

CMIMI  
**8.500 Lek**



**KARROCE UJI ME RROTA PA ZORRE**

- | Diametri 1/2" 100 m
- | Diametri 5/8" 80 m
- | Diametri 3/4" 100 m

MADE IN GERMANY

Kodi 18511-20

CMIMI  
**9.500 Lek**



**KARROCE UJI METALIKE PA ZORRE**

- | Diametri 1/2" 100 m
- | Diametri 5/8" 80 m
- | Diametri 3/4" 50 m

MADE IN GERMANY

Kodi 18541-20

CMIMI  
**11.900 Lek**



**KARROCE UJI METALIKE PA ZORRE**

- | Diametri 1/2" 100 m
- | Diametri 5/8" 80 m
- | Diametri 3/4" 50 m

MADE IN GERMANY

Kodi 18520-20

CMIMI  
**12.900 Lek**



1  
2  
3  
4  
5  
6  
7  
8  
9  
10





**KARRUKULL UJI  
AUTOMATIKE**

MADE IN GERMANY

- | Diametri 1/2"
- | Gjatesia 15 m



Kodi 18600-20

**CMIMI  
19.900 Lek**



**KARRUKULL UJI  
AUTOMATIKE**

MADE IN GERMANY

- | Diametri 1/2"
- | Gjatesia 25 m

Kodi 18620-20

**CMIMI  
29.900 Lek**



**KARRUKULL UJI  
AUTOMATIKE ERGO**

- | Diametri 1/2"
- | Gjatesia 20 m

Kodi 55-410

**CMIMI  
19.500 Lek**



**KARROCE UJI ALUMINI  
SET DISCOVER**

- | Diametri 1/2"
- | Gjatesia 20 m

Kodi 55-620

**CMIMI  
9.500 Lek**



**KARROCE UJI  
ALUPLUS IDEAL**

- | Diametri 1/2"
- | Gjatesia 20 m

Kodi 55-834

**CMIMI  
5.500 Lek**



**KARRUKULL UJI  
1/2**

- | Gjatesia tubit 15 m
- | Presioni 150 psi

Kodi WVZ1515

**CMIMI  
6.900 Lek**





1  
2  
3  
4  
5  
6  
7  
8  
9  
10

GARDENA

MADE IN GERMANY

### ZORRE UJI CLASSIC

- | Diametri 1/2"
- | Gjatesia 20 m
- | Presioni 22 bar

Kodi 18003-20

CMIMI  
2.990 Lek



GARDENA

MADE IN GERMANY

### ZORRE UJI CLASSIC

- | Diametri 1/2"
- | Gjatesia 30 m
- | Presioni 22 bar

Kodi 18009-20

CMIMI  
4.500 Lek



GARDENA

MADE IN GERMANY

### ZORRE UJI CLASSIC

- | Diametri 5/8"
- | Gjatesia 20 m
- | Presioni 22 bar

Kodi 18013-26

CMIMI  
3.900 Lek



GARDENA

MADE IN GERMANY

### ZORRE UJI CLASSIC

- | Diametri 1/2"
- | Gjatesia 50 m
- | Presioni 22 bar

Kodi 18010-20

CMIMI  
7.500 Lek



GARDENA

MADE IN GERMANY

### ZORRE UJI CLASSIC

- | Diametri 3/4"
- | Gjatesia 50 m
- | Presioni 22 bar

Kodi 18025-20

CMIMI  
11.500 Lek



GARDENA

MADE IN GERMANY

### ZORRE UJI FLEX

- | Diametri 1/2"
- | Gjatesia 30 m
- | Presioni 25 bar

Kodi 18036-20

CMIMI  
4.900 Lek



GARDENA

MADE IN GERMANY

### ZORRE UJI FLEX

- | Diametri 1/2"
- | Gjatesia 50 m
- | Presioni 25 bar

Kodi 18039-20

CMIMI  
8.500 Lek



GARDENA

MADE IN GERMANY

### ZORRE UJI FLEX

- | Diametri 3/4"
- | Gjatesia 50 m
- | Presioni 25 bar

Kodi 18055-20

CMIMI  
13.500 Lek



**30  
YEARS  
GUARANTEE**



MADE IN ITALY

**Fitt**  
TECHNOLOGY FLOW

**Tub uji Jeans me 6 shtresa**

Kodi	Diam.	m	Çmimi
76196.16625.59	1/2"	25 m	<b>3.900</b>
76196.16650.59	1/2"	50 m	<b>7.500</b>
76196.20625.59	5/8"	25 m	<b>4.500</b>
76196.20650.59	5/8"	50 m	<b>8.500</b>
76196.30625.59	3/4"	25 m	<b>6.500</b>
76196.30650.59	3/4"	50 m	<b>12.500</b>
76196.42925.59	1"	25 m	<b>8.500</b>
76196.42950.59	1"	50 m	<b>15.900</b>

**30  
YEARS  
GUARANTEE**



MADE IN ITALY

**Fitt**  
TECHNOLOGY FLOW

**Tub uji NTS ORANGE i papërthyeshtëm me 6 shtresa**

Kodi	Diam.	m	Çmimi
76199.16625.59	1/2"	25 m	<b>3.900</b>
76199.16650.59	1/2"	50 m	<b>7.900</b>
76199.30625.59	3/4"	25 m	<b>5.900</b>
76199.30650.59	3/4"	50 m	<b>11.500</b>

**10  
YEARS  
GUARANTEE**



MADE IN ITALY

**Fitt**  
TECHNOLOGY FLOW

**Tub uji Fitt Mint me 4 shtresa**

Kodi	Diam.	m	Çmimi
71017.16625.59	1/2"	25 m	<b>1.700</b>
71017.16650.59	1/2"	50 m	<b>3.500</b>
71017.20625.59	5/8"	25 m	<b>2.300</b>
71017.20650.59	5/8"	50 m	<b>3.900</b>
71017.30625.59	3/4"	25 m	<b>3.500</b>
71017.42925.59	1"	25 m	<b>5.900</b>
71017.42950.59	1"	50 m	<b>11.500</b>

**15  
YEARS  
GUARANTEE**



MADE IN ITALY

**Fitt**  
TECHNOLOGY FLOW

**Tub uji Flora i papërthyeshtëm me 5 shtresa**

Kodi	Diam.	m	Çmimi
77042.16625.59	1/2"	25 m	<b>3.000</b>
77042.16650.59	1/2"	50 m	<b>5.900</b>
77042.20625.59	5/8"	25 m	<b>3.900</b>
77042.20650.59	5/8"	50 m	<b>7.500</b>
77042.30625.59	3/4"	25 m	<b>5.500</b>
77042.30650.59	3/4"	50 m	<b>9.900</b>
77042.42925.59	1"	25 m	<b>8.500</b>
77042.42950.59	1"	50 m	<b>14.900</b>

**5  
YEARS  
GUARANTEE**



MADE IN ITALY

**Fitt**  
TECHNOLOGY FLOW

**Tub uji Mimosa me 3 shtresa**

Kodi	Diam.	m	Çmimi
71300.16625.59	1/2"	25 m	<b>1.900</b>
71300.16650.59	1/2"	50 m	<b>3.900</b>
71300.20625.59	5/8"	25 m	<b>2.500</b>
71300.20650.59	5/8"	50 m	<b>4.900</b>
71300.30625.59	3/4"	25 m	<b>3.690</b>
71300.30650.59	3/4"	50 m	<b>6.900</b>
71300.42925.59	1"	25 m	<b>5.900</b>
71300.42950.59	1"	50 m	<b>11.500</b>

**5  
YEARS  
GUARANTEE**



MADE IN ITALY

**Fitt**  
TECHNOLOGY FLOW

**Tub uji Idro Yellow me 3 shtresa**

Kodi	Diam.	m	Çmimi
71021.16625.59	1/2"	25 m	<b>990</b>
71021.16650.59	1/2"	50 m	<b>1.990</b>
71021.20625.59	5/8"	25 m	<b>1.290</b>
71021.20650.59	5/8"	50 m	<b>2.690</b>
71021.30625.59	3/4"	25 m	<b>1.990</b>
71021.30650.59	3/4"	50 m	<b>4.500</b>
71021.42925.59	1"	25 m	<b>3.900</b>
71021.42950.59	1"	50 m	<b>7.900</b>

**2**  
YEARS  
GUARANTEE



**Tub uji Idro Color me 2 shtresa**

Kodi	Diam.	m	Çmimi
71039.42950.59	1"	50 m	<b>8.900</b>



**MADE IN GERMANY**



**Set Tub uji Flex + pistolette, adaptor, rakorderi dhe bashkuese**

Kodi	Diam.	m	Çmimi
18034-20	1/2"	20 m	<b>6.500</b>

**30**  
YEARS  
GUARANTEE



**Kit NTS ORANGE i papërthyeshtëm me 6 shtresa + pistolette, bashkuese dhe adaptor**

Kodi	Diam.	m	Çmimi
76199.16620.59	1/2"	20 m	<b>4.500</b>



**Kit Tub uji Idro Color me 2 shtresa + pistolette dhe rakorderi**

Kodi	Diam.	m	Çmimi
76525.20620.59000	5/8"	20 m	<b>4.900</b>



**Set rakorderi dhe tub ATS-V i papërthyeshtëm me 5 shtresa**

Kodi	Diam.	m	Çmimi
13-390	1/2"	20 m	<b>6.500</b>



**Set rakorderi dhe tub ATS Green i papërthyeshtëm me 5 shtresa**

Kodi	Diam.	m	Çmimi
15-109	1/2"	20 m	<b>3.500</b>





Set Tub uji Idro Green Ekonomik me 3 shtresa dhe rakorderi

Kodi	Diam.	m	Çmimi
10-100	1/2"	20 m	<b>1.500</b>
10-102	3/4"	20 m	<b>2.900</b>



Tub uji ATS-2 Hobby i paperthyeshem me 6 shtresa

Kodi	Diam.	m	Çmimi
16-200	1/2"	25 m	<b>3.900</b>
16-201	1/2"	50 m	<b>6.900</b>
16-221	3/4"	50 m	<b>12.500</b>



Tub uji ATS Green i paperthyeshem me 5 shtresa

Kodi	Diam.	m	Çmimi
15-100	1/2"	25 m	<b>3.500</b>
15-101	1/2"	50 m	<b>6.500</b>
15-120	3/4"	25 m	<b>5.900</b>
15-121	3/4"	25 m	<b>9.900</b>



Tub uji Idro Blue Basic me 3 shtresa

Kodi	Diam.	m	Çmimi
10-400	1/2"	20 m	<b>1.750</b>
10-401	1/2"	30 m	<b>2.500</b>
10-402	1/2"	50 m	<b>3.500</b>
10-422	3/4"	50 m	<b>7.500</b>



Tub uji Yellow me 4 shtresa

Kodi	Diam.	m	Çmimi
10-500	1/2"	20 m	<b>1.350</b>
10-501	1/2"	30 m	<b>1.950</b>
10-502	1/2"	50 m	<b>2.990</b>
10-522	3/4"	50 m	<b>6.900</b>



Tub uji Idro Green Ekonomik me 3 shtresa

Kodi	Diam.	m	Çmimi
10-005	1/2"	20 m	<b>990</b>
10-003	1/2"	30 m	<b>1.990</b>
10-023	3/4"	25 m	<b>2.500</b>
10-022	3/4"	50 m	<b>3.500</b>



**Tub uji Color Elastic Eco Portokalli me 1 shtrese PVC super rezistente**

Kodi	Diam.	m	Çmimi
MG10013	1/2"	25 m	<b>1.800</b>
MG10014	1/2"	50 m	<b>3.500</b>
MG10031	3/4"	50 m	<b>5.900</b>
MG10032	1"	50 m	<b>8.500</b>



**Tub uji Color Elastic Standard Jeshile me 1 shtrese PVC super rezistente**

Kodi	Diam.	m	Çmimi
MG10010	1/2"	25 m	<b>1.900</b>
MG10011	1/2"	50 m	<b>3.900</b>
MG10030	3/4"	50 m	<b>6.900</b>
MG10040	1"	50 m	<b>9.500</b>



**Tub uji Idro Lili me 3 shtresa**

Kodi	Diam.	m	Çmimi
MF30140	1/2"	25 m	<b>1.900</b>
MF30141	1/2"	50 m	<b>3.500</b>
MF30142	3/4"	50 m	<b>6.500</b>
MF30143	1"	50 m	<b>8.900</b>



**Tub uji Doris me 3 shtresa**

Kodi	Diam.	m	Çmimi
MF30010	1/2"	25 m	<b>1.700</b>
MF30011	1/2"	50 m	<b>2.990</b>
MF30030	3/4"	50 m	<b>5.500</b>
MF30040	1"	50 m	<b>7.900</b>



**Tub uji Blue Line**

Kodi	Diam.	m	Çmimi
MF30144	1/2"	50 m	<b>5.500</b>
MF30145	3/4"	50 m	<b>9.500</b>
MF30146	1"	50 m	<b>12.500</b>



**Tub uji Termo Standart**

Kodi	Diam.	m	Çmimi
MT20010	1/2"	50 m	<b>3.500</b>
MT20030	3/4"	50 m	<b>5.900</b>
MT20040	1"	50 m	<b>7.900</b>

AK Palaplast



### Tub Thithes Spiral Jeshil

Kodi	Diam.	m	Çmimi
4076/1019	3/4" / 19 mm	50 m	<b>6.500</b>
4076/1025	1" / 25 mm	50 m	<b>6.900</b>
4076/1032	1 1/4" / 32 mm	50 m	<b>11.500</b>
4076/1038	1 1/2" / 38 mm	50 m	<b>16.500</b>

AK Palaplast



### Tub Thithes Spiral Jeshil Heavy Duty

Kodi	Diam.	m	Çmimi
4076/2050	2" / 51 mm	50 m	<b>24.500</b>
4076/2075	3" / 76 mm	50 m	<b>39.900</b>
4076/2100	4" / 102 mm	50 m	<b>59.900</b>

AK Palaplast



### Tub uji petashuk 6 ATM

Kodi	Diam.	m	Çmimi
4406/0652	2" / 53 mm	100 m	<b>11.900</b>
4406/0478	3" / 78 mm	100 m	<b>17.900</b>

VOREL



### Tub uji petashuk 2 Bar

Kodi	Diam.	m	Çmimi
79983	2"	50 m	<b>5.900</b>
79984	3"	50 m	<b>8.900</b>

VOREL



### Tub Pikimi Vadites Plastik

Kodi	Dia/Metrat	Çmimi
89373	16mm/30m	<b>1.890</b>

plahosan





































### Tub niveli

Kodi	Diam.	m	Çmimi
MH20020	8 mm	100 m	<b>2.500</b>
MH20030	10 mm	100 m	<b>3.300</b>









<p>18300-20</p> <p><b>GARDENA</b> <b>MADE IN GERMANY</b></p>  <p>Çmimi <b>950</b></p> <p><b>FROST PROOF</b></p>	<p>18301-20</p> <p><b>GARDENA</b> <b>MADE IN GERMANY</b></p>  <p>Çmimi <b>1.700</b></p> <p><b>FROST PROOF</b></p>	<p>18303-20</p> <p><b>GARDENA</b> <b>MADE IN GERMANY</b></p>  <p>Çmimi <b>2.390</b></p> <p><b>FROST PROOF</b></p>
<p><b>Pistoletë vaditje</b></p> <p>Koke plastike kunder goditjeve</p>		
<p>18305-20</p> <p><b>GARDENA</b> <b>MADE IN GERMANY</b></p>  <p>Çmimi <b>3.500</b></p> <p><b>FROST PROOF</b></p>	<p>961-20</p> <p><b>GARDENA</b> <b>MADE IN GERMANY</b></p>  <p>Çmimi <b>3.990</b></p>	<p>18311-20</p> <p><b>GARDENA</b> <b>MADE IN GERMANY</b></p>  <p>Çmimi <b>2.200</b></p>
<p><b>Pistoletë vaditje Classic</b></p> <p>Me 2 lloje sperkatje, bllokues doreze</p>		
<p><b>Pistoletë vaditje Comfort</b></p> <p>Me 3 lloje sperkatje, bllokues doreze</p>		
<p><b>Pistoletë vaditje metalike</b></p> <p>Me 2 lloje sperkatje</p>	<p><b>Dush për ambiente të jashtme</b></p> <p>Lartësia totale: 207</p>	<p><b>Pistoletë me sprcime të imët</b></p> <p>Dorezë e gomuar</p>
<p>18313-20</p> <p><b>GARDENA</b> <b>MADE IN GERMANY</b></p>  <p>Çmimi <b>3.200</b></p>	<p>18298-20</p> <p><b>GARDENA</b> <b>MADE IN GERMANY</b></p>  <p>Çmimi <b>5.500</b></p>	<p>18330-20</p> <p><b>GARDENA</b> <b>MADE IN GERMANY</b></p>  <p>Çmimi <b>3.000</b></p>
<p><b>Pistoletë me 3 lloje sprcimesh</b></p> <p>Dorezë e gomuar, Bllokues doreze</p>	<p><b>Set vaditje me pistoletë ujitje</b></p> <p>+ rakorderi, rakorderi e shpejtë, adaptor</p>	<p><b>Pistoletë vaditje me stekë</b></p> <p>Me sprcime të imët, Bllokues doreze</p>
<p>18312-33</p> <p><b>GARDENA</b> <b>MADE IN GERMANY</b></p>  <p>Çmimi <b>1.890</b></p>	<p>18299-34</p> <p><b>GARDENA</b> <b>MADE IN GERMANY</b></p>  <p>Çmimi <b>2.390</b></p>	<p>18291-20</p> <p><b>GARDENA</b> <b>MADE IN GERMANY</b></p>  <p>Çmimi <b>2.390</b></p>
<p><b>Set vaditje</b></p> <p>Pistoletë ujitje dhe rakorderi e shpejtë 1/2"</p>	<p><b>Set vaditje</b></p> <p>Pistoletë ujitje dhe set rakorderi e shpejtë</p>	<p><b>Set vaditje me 2 rakorderi</b></p> <p>1/2", 5/8" Adaptor rubineti G 3/4 dhe G1.</p>













<p>18215-50</p> <p> <b>MADE IN GERMANY</b> </p>  <p>Çmimi <b>690</b></p> <p><b>Rakorderi e shpejte</b></p> <p>1/2"</p>	<p>18216-20</p> <p> <b>MADE IN GERMANY</b> </p>  <p>Çmimi <b>850</b></p> <p><b>Rakorderi e shpejte</b></p> <p>3/4"</p>	<p>18213-20</p> <p> <b>MADE IN GERMANY</b> </p>  <p>Çmimi <b>790</b></p> <p><b>Rakorderi e shpejte</b></p> <p>Me bllokues uji 1/2"</p>
<p>18214-20</p> <p> <b>MADE IN GERMANY</b> </p>  <p>Çmimi <b>990</b></p> <p><b>Rakorderi e shpejte</b></p> <p>Me bllokues uji 3/4"</p>	<p>18232-20</p> <p> <b>MADE IN GERMANY</b> </p>  <p>Çmimi <b>550</b></p> <p><b>Bashkuese tubi</b></p> <p>13 mm (1/2") - 15 mm (5/8")</p>	<p>18233-20</p> <p> <b>MADE IN GERMANY</b> </p>  <p>Çmimi <b>650</b></p> <p><b>Bashkuese tubi</b></p> <p>3/4"</p>
<p>18220-20</p> <p> <b>MADE IN GERMANY</b> </p>  <p>Çmimi <b>330</b></p> <p><b>Adaptor rubineti</b></p> <p>1/2"</p>	<p>18221-50</p> <p> <b>MADE IN GERMANY</b> </p>  <p>Çmimi <b>370</b></p> <p><b>Adaptor rubineti</b></p> <p>3/4"</p>	<p>18222-50</p> <p> <b>MADE IN GERMANY</b> </p>  <p>Çmimi <b>390</b></p> <p><b>Adaptor rubineti</b></p> <p>G1"</p>
<p>2921-20</p> <p> <b>MADE IN GERMANY</b> </p>  <p>Çmimi <b>390</b></p> <p><b>Adaptor rubineti</b></p> <p>Mashkull 3/4"</p>	<p>2931-20</p> <p> <b>MADE IN GERMANY</b> </p>  <p>Çmimi <b>390</b></p> <p><b>Bashkuese tubi</b></p> <p>Per 2 lidhje</p>	<p>5552-20</p> <p> <b>MADE IN GERMANY</b> </p>  <p>Çmimi <b>3.500</b></p> <p><b>Doreze e pershkueshme</b></p> <p>Nga uji 90 cm</p>

<p>8201-29</p> <p> <b>MADE IN GERMANY</b> </p>  <p>Çmimi <b>2.890</b></p>	<p>8203-29</p> <p> <b>MADE IN GERMANY</b> </p>  <p>Çmimi <b>4.500</b></p>	<p>8205-29</p> <p> <b>MADE IN GERMANY</b> </p>  <p>Çmimi <b>4.900</b></p>
<p><b>Vadites i fshehur</b></p> <p>T100 / 50-100 m<sup>2</sup></p>	<p><b>Vadites i fshehur</b></p> <p>T200 / 80-200 m<sup>2</sup></p>	<p><b>Vadites i fshehur</b></p> <p>T380 / 380 m<sup>2</sup></p>
<p>8133-20</p> <p> <b>MADE IN GERMANY</b> </p>  <p>Çmimi <b>2.900</b></p>	<p>13135-34</p> <p> <b>MADE IN GERMANY</b> </p>  <p>Çmimi <b>6.900</b></p>	<p>1210-20</p> <p> <b>MADE IN GERMANY</b> </p>  <p>Çmimi <b>1.100</b></p>
<p><b>Automat Aqua Contour</b></p> <p>Per sip.380 m<sup>2</sup></p>	<p><b>Set ftohjeje me uje</b></p> <p>Per ambiente të jashtme</p>	<p><b>Shperndares me dy dalje</b></p> <p>¾" dhe 1"</p>
<p>2065-20</p> <p> <b>MADE IN GERMANY</b> </p>  <p>Çmimi <b>3.990</b></p>	<p>7819-20</p> <p> <b>MADE IN GERMANY</b> </p>  <p>Çmimi <b>990</b></p>	<p>7884-20</p> <p> <b>MADE IN GERMANY</b> </p>  <p>Çmimi <b>200</b></p>
<p><b>Vadites me bazament</b></p> <p>Tango / 310 m<sup>2</sup></p>	<p><b>Hedhes uji ne forme</b></p> <p>Shkume 1</p>	<p><b>Tab teleskop</b></p> <p>Per kokat e shatervaneve G3/4</p>
<p>1890-29</p> <p> <b>MADE IN GERMANY</b> </p>  <p>Çmimi <b>7.900</b></p>	<p>52-090</p> <p></p>  <p>Çmimi <b>1.900</b></p>	<p>WQC5534</p> <p></p>  <p>Çmimi <b>3.500</b></p>
<p><b>Ore kompiuterike</b></p> <p>Per kontrollin e vaditjes</p>	<p><b>Ore per vaditje IDEAL</b></p> <p>Me regjistrim mekanik deri 120min ¾"-1"</p>	<p><b>Ore vaditje dixhitale</b></p> <p>Prurja 50 Lt/min, 4 bar</p>





















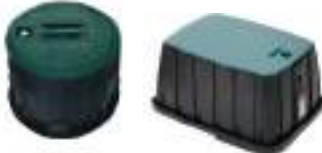

















<p>53-320</p> <p><b>cellfast</b></p>  <p>Çmimi <b>1.650</b></p>	<p>53-340</p> <p><b>cellfast</b></p>  <p>Çmimi <b>2.390</b></p>	<p>53-530</p> <p><b>cellfast</b></p>  <p>Çmimi <b>2.990</b></p>
<p><b>Pistoletë vaditje ERGO</b></p> <p>Pistoletë ujitje dhe rakorderi e shpejtë</p>	<p><b>Pistoletë ujitje koke dushi</b></p> <p>me 4 sprucime ERGO</p>	<p><b>Pistoletë vaditje ERGO</b></p> <p>Me 4 sprucime dhe rakorderi 1/2", 3/4", 1"</p>
<p>50-700</p> <p><b>cellfast</b></p>  <p>Çmimi <b>350</b></p>	<p>50-740</p> <p><b>cellfast</b></p>  <p>Çmimi <b>1.100</b></p>	<p>50-750</p> <p><b>cellfast</b></p>  <p>Çmimi <b>1.390</b></p>
<p><b>Pistoletë vaditje e drejte</b></p> <p>1/2" me 2 funksione IDEAL</p>	<p><b>Pistoletë vaditje multifunksionale</b></p> <p>1/2" - 5/8" VARIANT IDEAL</p>	<p><b>Pistoletë vaditje multifunksionale</b></p> <p>Koke dushi me rakorderi 1/2"-5/8" IDEAL</p>
<p>50-737</p> <p><b>cellfast</b></p>  <p>Çmimi <b>650</b></p>	<p>50-738</p> <p><b>cellfast</b></p>  <p>Çmimi <b>820</b></p>	<p>50-760</p> <p><b>cellfast</b></p>  <p>Çmimi <b>1.100</b></p>
<p><b>Pistoletë vaditje</b></p> <p>1/2" me 2 funksione HYDRON</p>	<p><b>Pistoletë vaditje koke dushi</b></p> <p>Me 6 funksione HYDRON</p>	<p><b>Pistoletë vaditje koke dushi</b></p> <p>Me rakorderi 1/2" - 5/8" HYDRON</p>
<p>52-320</p> <p><b>cellfast</b></p>  <p>Çmimi <b>1.490</b></p>	<p>52-321</p> <p><b>cellfast</b></p>  <p>Çmimi <b>1.250</b></p>	<p>52-340</p> <p><b>cellfast</b></p>  <p>Çmimi <b>1.450</b></p>
<p><b>Pistoletë vaditje koke dushi</b></p> <p>Me 7 funksione BASIC</p>	<p><b>Pistoletë vaditje</b></p> <p>Me 3 funksione BASIC</p>	<p><b>Steke vaditje koke dushi</b></p> <p>Me 10 funksione BASIC</p>

<p>50-500</p>   <p>Çmimi <b>590</b></p>	<p>50-505</p>   <p>Çmimi <b>650</b></p>	<p>50-630</p>   <p>Çmimi <b>250</b></p>
<p><b>Set pistolete vaditje</b></p> <p>Me rakorderi 1/2" BASIC</p>	<p><b>Set pistolete vaditje</b></p> <p>Me rakorderi 3/4" BASIC</p>	<p><b>Rakorderi e shpejte</b></p> <p>1/2" - 5/8" IDEAL</p>
<p>51-130H</p>   <p>Çmimi <b>170</b></p>	<p>50-635</p>   <p>Çmimi <b>290</b></p>	<p>51-135H</p>   <p>Çmimi <b>190</b></p>
<p><b>Rakorderi e shpejte</b></p> <p>1/2"-5/8" BASIC</p>	<p><b>Rakorderi e shpejte</b></p> <p>3/4" IDEAL</p>	<p><b>Rakorderi e shpejte</b></p> <p>3/4" BASIC</p>
<p>51-133</p>   <p>Çmimi <b>160</b></p>	<p>50-600</p>   <p>Çmimi <b>195</b></p>	<p>50-605</p>   <p>Çmimi <b>235</b></p>
<p><b>Rakorderi e shpejte</b></p> <p>Me valvul 3/4" BASIC</p>	<p><b>Bashkuese tubi</b></p> <p>1/2" IDEAL</p>	<p><b>Bashkuese tubi</b></p> <p>3/4" IDEAL</p>
<p>50-610</p>   <p>Çmimi <b>235</b></p>	<p>50-640</p>   <p>Çmimi <b>165</b></p>	<p>51-100H</p>   <p>Çmimi <b>135</b></p>
<p><b>Bashkuese tubi</b></p> <p>Me reduktim 3/4" - 1/2" IDEAL</p>	<p><b>Bashkuese tubi</b></p> <p>Me 2 dalje IDEAL</p>	<p><b>Bashkuese tubi</b></p> <p>1/2" BASIC</p>

<p>51-105H</p> <p><b>cellfast</b></p>  <p>Çmimi <b>155</b></p>	<p>51-110H</p> <p><b>cellfast</b></p>  <p>Çmimi <b>155</b></p>	<p>50-650</p> <p><b>cellfast</b></p>  <p>Çmimi <b>150</b></p>
<p><b>Bashkuese tubi</b></p> <p>3/4" BASIC</p>	<p><b>Bashkuese tubi</b></p> <p>Me reduktim 3-4" - 1/2" BASIC</p>	<p><b>Adaptor rubineti</b></p> <p>Femer 1/2" IDEAL</p>
<p>50-652</p> <p><b>cellfast</b></p>  <p>Çmimi <b>230</b></p>	<p>50-655</p> <p><b>cellfast</b></p>  <p>Çmimi <b>160</b></p>	<p>50-657</p> <p><b>cellfast</b></p>  <p>Çmimi <b>290</b></p>
<p><b>Adaptor rubineti</b></p> <p>Femer 1/2"-3/4" IDEAL</p>	<p><b>Adaptor rubineti</b></p> <p>Femer 3/4" IDEAL</p>	<p><b>Adaptor rubineti</b></p> <p>Femer 3/4"-1" IDEAL</p>
<p>50-660</p> <p><b>cellfast</b></p>  <p>Çmimi <b>190</b></p>	<p>50-665</p> <p><b>cellfast</b></p>  <p>Çmimi <b>150</b></p>	<p>50-670</p> <p><b>cellfast</b></p>  <p>Çmimi <b>160</b></p>
<p><b>Adaptor rubineti</b></p> <p>Femer 1" IDEAL</p>	<p><b>Adaptor rubineti</b></p> <p>Mashkull 1/2" IDEAL</p>	<p><b>Adaptor rubineti</b></p> <p>Mashkull 3/4" IDEAL</p>
<p>51-220H</p> <p><b>cellfast</b></p>  <p>Çmimi <b>110</b></p>	<p>51-210H</p> <p><b>cellfast</b></p>  <p>Çmimi <b>90</b></p>	<p>51-215H</p> <p><b>cellfast</b></p>  <p>Çmimi <b>100</b></p>
<p><b>Adaptor rubineti</b></p> <p>Femer 1" BASIC</p>	<p><b>Adaptor rubineti</b></p> <p>Femer 1/2" BASIC</p>	<p><b>Adaptor rubineti</b></p> <p>Femer 3/4" BASIC</p>















<p>52-220</p>  <p>Çmimi <b>790</b></p>	<p>52-257</p>  <p>Çmimi <b>420</b></p>	<p>52-304</p>  <p>Çmimi <b>1.250</b></p>												
<p><b>Rubinet dysh</b> Per ndarjen e ujit 3/4"-1" IDEAL</p>	<p><b>Adaptor rubineti</b> Me filter per lavazhe IDEAL</p>	<p><b>Sperkates metalik</b> 350 m<sup>2</sup> BASIC</p>												
<p>52-405</p>  <p>Çmimi <b>850</b></p>	<p>52-305</p>  <p>Çmimi <b>1.850</b></p>	<p>08241-20</p>  <p>Çmimi <b>1.190</b></p>												
<p><b>Sperkates plastik</b> 350 m<sup>2</sup> ECONOMIC</p>	<p><b>Sperkates me oshilim</b> 250 - 300 m<sup>2</sup> BASIC</p>	<p><b>Vadites i fshehur</b> SD30 / 30m<sup>2</sup></p>												
<p>1569-29</p>  <p>Çmimi <b>1.290</b></p>	<p>89162</p>  <p>Çmimi <b>490</b></p>	<p>89163</p>  <p>Çmimi <b>490</b></p>												
<p><b>Vadites i fshehur</b> S80 / 80 m<sup>2</sup></p>	<p><b>Vadites i fshehur</b> 1/2" F , 25-360grade 8 m</p>	<p><b>Vadites i fshehur</b> 1/2" F , 25-360grade 10 m</p>												
<p>89164</p>  <p>Çmimi <b>690</b></p>	<p>Pusete plastike per sistem vaditje</p> 	<p>89109</p>  <p>Çmimi <b>490</b></p>												
<p><b>Vadites i fshehur</b> 1/2" F , 25-360grade 15 m</p>	<table border="1"> <thead> <tr> <th>Kodi</th> <th>Pershkrimi</th> <th>Çmimi</th> </tr> </thead> <tbody> <tr> <td>88780</td> <td>10" e rrumbullaket</td> <td><b>1.290</b></td> </tr> <tr> <td>88783</td> <td>12" katrore</td> <td><b>3.500</b></td> </tr> <tr> <td>88784</td> <td>14" katrore</td> <td><b>3.990</b></td> </tr> </tbody> </table>	Kodi	Pershkrimi	Çmimi	88780	10" e rrumbullaket	<b>1.290</b>	88783	12" katrore	<b>3.500</b>	88784	14" katrore	<b>3.990</b>	<p><b>Adaptor rubineti bronzi</b> 3/4" &amp; 1"</p>
Kodi	Pershkrimi	Çmimi												
88780	10" e rrumbullaket	<b>1.290</b>												
88783	12" katrore	<b>3.500</b>												
88784	14" katrore	<b>3.990</b>												

<p>89105</p>   <p>Çmimi <b>790</b></p>	<p>89108</p>   <p>Çmimi <b>450</b></p>	<p>89106</p>   <p>Çmimi <b>290</b></p>
<p><b>Bashkuese bronzi</b></p> <p>3/4"</p>	<p><b>Adaptor bronzi per tub</b></p> <p>1/2" &amp; 3/4"</p>	<p><b>Adaptor rubineti</b></p> <p>Per tub 3/4"</p>
<p>89104</p>   <p>Çmimi <b>550</b></p>	<p>89100</p>   <p>Çmimi <b>590</b></p>	<p>89222</p>   <p>Çmimi <b>100</b></p>
<p><b>Bashkuese bronzi</b></p> <p>1/2"</p>	<p><b>Rakoderi e shpejte</b></p> <p>Bronzi 1/2"</p>	<p><b>Rakoderi e shpejte</b></p> <p>Plastike 1/2" me varje</p>
<p>89224</p>   <p>Çmimi <b>120</b></p>	<p>89225</p>   <p>Çmimi <b>80</b></p>	<p>89227</p>   <p>Çmimi <b>100</b></p>
<p><b>Rakoderi e shpejte</b></p> <p>Plastike 3/4" me varje</p>	<p><b>Rakoderi e shpejte</b></p> <p>1/2" me bllokues uji</p>	<p><b>Rakoderi e shpejte</b></p> <p>3/4" me bllokues uji</p>
<p>89233</p>   <p>Çmimi <b>120</b></p>	<p>89214</p>   <p>Çmimi <b>490</b></p>	<p>89211</p>   <p>Çmimi <b>550</b></p>
<p><b>Rakoderi reduktuese plastike</b></p> <p>3/4" &amp; 1/2"</p>	<p><b>Pistoletë uji plastike</b></p> <p>Me 3 funksione</p>	<p><b>Pistoletë uji me koke dushi</b></p> <p>Me 8 funksione</p>

<p>89242</p>   <p>Çmimi <b>80</b></p>	<p>89203</p>   <p>Çmimi <b>350</b></p>	<p>89204</p>   <p>Çmimi <b>290</b></p>
<p><b>Adaptor rubineti plastik</b> 3/4" &amp; 1/2"F me varje</p>	<p><b>Set me 4 rakorderi plastike</b> 3/4" &amp; 1" dhe pistolette vaditje</p>	<p><b>Set me 4 rakorderi plastike</b> 1/2" &amp; 3/4"</p>
<p>89252</p>   <p>Çmimi <b>100</b></p>	<p>89259</p>   <p>Çmimi <b>650</b></p>	<p>89272</p>   <p>Çmimi <b>290</b></p>
<p><b>Adaptor rubineti plastik</b> 1" &amp; 3/4"F me varje</p>	<p><b>Sperkates metalik</b> 24m 45-360grade</p>	<p><b>Sperkates plastik</b> 1/2" 360 grade 14m</p>
<p>89261</p>   <p>Çmimi <b>350</b></p>	<p>GH9040-D</p>   <p>Çmimi <b>100</b></p>	<p>WQC2E33</p>   <p>Çmimi <b>250</b></p>
<p><b>Sperkates plastik</b> 1/2" 45-360 grade 24m</p>	<p><b>Adaptor me filetimit</b> Mashkull 3/4"</p>	<p><b>Set me 3 rakorderi</b> 1/2"</p>
<p>HPHM0201</p>   <p>Çmimi <b>120</b></p>	<p>HHCS01122</p>   <p>Çmimi <b>140</b></p>	<p>HHCS01342</p>   <p>Çmimi <b>100</b></p>
<p><b>Rakorderi e shpejte</b> 1/2"</p>	<p><b>Rakorderi e shpejte</b> 1/2"</p>	<p><b>Rakorderi e shpejte</b> 3/4"</p>



<p><b>HHC1202</b></p> <p><b>ingco</b></p>  <p>Çmimi <b>270</b></p>	<p><b>HHC1201</b></p> <p><b>ingco</b></p>  <p>Çmimi <b>170</b></p>	<p><b>HHCS03122</b></p> <p><b>ingco</b></p>  <p>Çmimi <b>230</b></p>
<p><b>Bashkuese tubi uji me 2 dalje</b></p> <p>Dalja e tubit: 1" - 3/4" me mbylles manual</p> <p><b>HHCS05122</b></p> <p><b>ingco</b></p>  <p>Çmimi <b>350</b></p>	<p><b>Rubinet dysh per ndarjen e ujit</b></p> <p>Dalja e tubit: 1/2"</p> <p><b>HPS13601</b></p> <p><b>ingco</b></p>  <p>Çmimi <b>990</b></p>	<p><b>Set me 3 rakorderi</b></p> <p>Rakorderi me bllokues uji 1/2"</p> <p>Rakorderi e shpejte 1/2" + adaptor 3/4"</p> <p><b>GH9242</b></p> <p><b>NAKAYAMA</b></p>  <p>Çmimi <b>390</b></p>
<p><b>Set me 5 rakorderi me pistolette ujitje</b></p> <p>Rakorderi me bllokues uji 1/2" Rakorderi e shpejte 1/2" + adaptor 3/4" &amp; 1/2"</p> <p><b>HPS23602</b></p> <p><b>ingco</b></p>  <p>Çmimi <b>450</b></p>	<p><b>Vadites siperfaqesor</b></p> <p>Me funksion 360°</p> <p><b>HPS0402</b></p> <p><b>ingco</b></p>  <p>Çmimi <b>1.550</b></p>	<p><b>Mbajtese plastike murale</b></p> <p>Per tuba uji</p> <p><b>55-260</b></p> <p><b>cellfast</b></p>  <p>Çmimi <b>4.990</b></p>
<p><b>Vadites me 3 krahe</b></p> <p>Permasa 16.5 x 14 x 8</p> <p><b>HWSG032</b></p> <p><b>ingco</b></p>  <p>Çmimi <b>350</b></p>	<p><b>Karrukull plastike per tub uji</b></p> <p>1/2"*40m (montohet edhe ne mur)</p> <p><b>HWSG092</b></p> <p><b>ingco</b></p>  <p>Çmimi <b>450</b></p>	<p><b>Karroce uji metalike ALUPLUS</b></p> <p>Diametri 1/2", Per tub 60m</p> <p><b>HHW092</b></p> <p><b>ingco</b></p>  <p>Çmimi <b>250</b></p>
<p><b>Pistolette vaditje plastike</b></p> <p>Permasa 250 mm</p>	<p><b>Pistolette vaditje plastike</b></p> <p>Me koke dushi 250 mm</p>	<p><b>Steke me koke dushi</b></p> <p>Me 9 lloje sperkatjesh</p>

3091



**Pikues Lotues i rregullueshem ne tub**

Kodi	Permasa	Paketimi	Çmimi
3091/0000	I kuq 0-70L/H	50 cope	15
3091/0007	I zi 0-70L/H	50 cope	15
3091/0070	I verdhe 0-70L/H	50 cope	15

3091



**Pikues Lotues i rregullueshem ne tub**

Kodi	Permasa	Paketimi	Çmimi
3091/0100	jeshil 0-100L/H	40 cope	16

3093



**Pikues Lotues i rregullueshem ne tub**

Kodi	Permasa	Paketimi	Çmimi
3093/0150	I zi 0-150L/H	35 cope	18

3195



**Pikues Lotues i rregullueshem ne tub**

Kodi	Permasa	Paketimi	Çmimi
3195/1070	I kuq me kunjë 0-70L/H	30 cope	45
3195/2070	I zi me kunjë 0-70L/H	30 cope	45

3090



**Pikues Direkt per tub**

Kodi	Permasa	Paketimi	Çmimi
3090/0004	Jeshil 2L/H, 12-32 mm	50 cope	35
3090/0006	I kuq 6L/H, 12-32 mm	50 cope	35
3090/0008	Blu 8L/H, 12-32 mm	50 cope	35

3088



**Mikropikues Direkt Hydra per tub**

Kodi	Permasa	Paketimi	Çmimi
3088/0002	I kuq 2L/H, 16-32 mm	50 cope	25
3088/0004	Jeshil 2L/H, 16-32 mm	50 cope	25

3114



**Shigjete pikimi e harkuar 30 Grade**

Kodi	Permasa	Paketimi	Çmimi
3114/3015	E zeze 2L/H	40 cope	20
3114/3040	Kafe 2L/H	40 cope	20

3113



**Shigjete suportuese e harkuar 30 grade**

Kodi	Permasa	Paketimi	Çmimi
3113/0003	Jeshile 3L/H	40 cope	20
3113/0004	Blu 4L/H	40 cope	20
3113/0005	E kuqe 5L/H	40 cope	20

3005



**Mikrosperkates Delta**

Kodi	Permasa	Paketimi	Çmimi
3005/0120	I kuq 120L/H / 10 m	20 cope	69
3005/0160	Kaf 160L/H / 10.5 m	20 cope	69
3005/0200	I verdhe 120L/H / 11 m	20 cope	69

3006



**Mikrosperkates 2000**

Kodi	Permasa	Paketimi	Çmimi
3006/0120	I kuq 120L/H / 10 m	20 cope	75
3006/0160	Kaf 160L/H / 10.5 m	20 cope	75
3006/0200	I verdhe 120L/H / 11 m	20 cope	75

3003



**Mikrosperkates**

Kodi	Permasa	Paketimi	Çmimi
3003/0090	Jeshil 90L/H / 7.5 m	40 cope	39
3003/0120	I Kuq 120L/H / 8 m	40 cope	39
3003/0160	Kaf 160L/H / 8.5 m	40 cope	39
3003/0200	I verdhe 200L/H / 9 m	40 cope	39
3003/0300	Ulliri 300 L/H / 9.5 m	40 cope	39

3002



**Mikrosperkates**

Kodi	Permasa	Paketimi	Çmimi
3002/0090	Jeshil 90L/H / 7.5 m	40 cope	35
3002/0120	I Kuq 120L/H / 8 m	40 cope	35
3002/0160	Kaf 160L/H / 8.5 m	40 cope	35
3002/0200	I verdhe 200L/H / 9 m	40 cope	35



3013



### Mikrosperkates

Kodi	Permasa	Paketimi	Çmimi
3013/0040	Portokalli 40L/H / 2.5 m	40 cope	49
3013/0070	I Zi 70L/H / 3 m	40 cope	49
3013/0120	I Kuq 120L/H / 4.5 m	40 cope	49
3013/0200	I verdhe 200L/H / 5 m	40 cope	49

3023



### Mikrosperkates 90 grade

Kodi	Permasa	Paketimi	Çmimi
3023/0070	I Zi 70L/H / 3.5 m	40 cope	69
3023/0090	Jeshil 120L/H / 3.5 m	40 cope	69
3023/0120	I Kuq 120L/H / 4 m	40 cope	69

3024



### Mikrosperkates 180 grade

Kodi	Permasa	Paketimi	Çmimi
3024/0090	Jeshil 90L/H / 3.5 m	40 cope	69
3024/0105	Blu 105L/H / 4 m	40 cope	69
3024/0120	I Kuq 120L/H / 4 m	40 cope	69

3025



### Mikrosperkates 270 grade

Kodi	Permasa	Paketimi	Çmimi
3025/0090	Jeshil 90L/H / 3.5 m	40 cope	69
3025/0105	Blu 105L/H / 4 m	40 cope	69
3025/0120	I Kuq 120L/H / 4 m	40 cope	69

3017



### Mini-jet sperkates 180 grade

Kodi	Permasa	Paketimi	Çmimi
3017/0060	Gri 60L/H / 2.5 m	50 cope	12
3017/0090	Jeshil 90L/H / 2.5 m	50 cope	12
3017/0120	I Kuq 120L/H / 2.5 m	50 cope	12

3018



**Mini-jet sperkates 360 grade**

Kodi	Permasa	Paketimi	Çmimi
3018/0060	Gri 60L/H / 2.5 m	50 cope	12
3018/0090	Jeshil 60L/H / 2.5 m	50 cope	12
3018/0120	I Kuq 60L/H / 2.5 m	50 cope	12

3033



**Mjegullues 6 mm**

Kodi	Permasa	Paketimi	Çmimi
3033/1006	1X6,2lt/h, F/ 6 mm	10 cope	290
3033/4006	4X6,2lt/h, F/ 6 mm	10 cope	750
3033/5006	5X6,2lt/h, F/ 6 mm	10 cope	890

3051



**Kunje per sistemin e pikimit**

Kodi	Permasa	Ngjyra	Çmimi
3051/1840	8mm x 40 cm	I Kuq	100
3051/1250	12mm x 40 cm	I Zi	190

3054



**Adaptor per sistem pikimi**

Kodi	Permasa	Paketimi	Çmimi
3054/1006	I Kuq 6 mm	100 cope	12
3054/1008	I Zi 8 mm	100 cope	19

3112



**Kunje toke**

Kodi	Permasa	Paketimi	Çmimi
3112/1620	16 - 20 mm	100 cope	35

3068



**Pistolette shpuese manuale**

Kodi	Permasa	Paketimi	Çmimi
3068/1003	3 mm	Jeshile	590
3068/1004	4 mm	Blu	590
3068/1006	6 mm	E kuqe	590



**SHKALLË ALUMINI**  
**KARROCA, RAFTE METALIKE**  
**KOSHA, LITARË DHE ZINXHIRË**



## SHKALLE ALUMINI PROFESIONALE



MADE IN GERMANY

Certificate  
EN 131  
Norm

Kodi		Çmimi
000712	CORDA 1X3	4.500
000705	CORDA 1X4	5.500
000729	CORDA 1X5	6.500
000736	CORDA 1X6	7.500
000743	CORDA 1X7	9.900



## SHKALLE ALUMINI TEKE



MADE IN GERMANY



Certificate  
EN 131  
Norm

Kodi		Çmimi
010087	CORDA 1X8	5.900
010100	CORDA 1X10	7.500
030115	CORDA 1X11	8.500
030122	CORDA 1X12	9.900



## SHKALLE ALUMINI ME KOMBINIM



**MADE IN GERMANY**



Certificate  
**EN 131**  
Norm

Kodi		Çmimi
030283	CORDA 2X8	<b>14.500</b>
030221	CORDA 2X11	<b>17.900</b>
033376	CORDA 3X7	<b>17.900</b>
033390	CORDA 3X9	<b>22.500</b>
030429	CORDA 3X11	<b>29.900</b>
085214	me kombinim dhe platforme CORDA 4X3	<b>26.900</b>



## SHKALLE ALUMINI



**MADE IN GERMANY**



Certificate  
**EN 131**  
Norm

Kodi		Çmimi
120328	DOPPLO 2X3	<b>6.900</b>
120335	DOPPLO 2X4	<b>9.900</b>
120359	DOPPLO 2X6	<b>14.500</b>



## SKELE ALUMINI / ME 1 ZGJERIM / ME 2 ZGJERIME

**ClimTec**  
System

MADE IN GERMANY

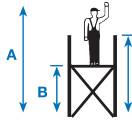

Lartesia A  
Lartesia B  
Lartesia C

	Baza	Baza + shtesa 1	Baza + shtesa 1&2
Lartesia A	3.00	5.00	7.00
Lartesia B	1.00	3.00	5.00
Lartesia C	1.95	4.00	6.00
Permasa e bazes	1.92 x 1.42	1.92 x 1.42	1.92 x 1.42
Permasa e platformes	1.50 x 0.60	1.50 x 0.60	1.50 x 0.60
Gjeresia	1.5	1.5	1.5
Thellesia	0.65	0.65	0.65
Pesha	31	54	84



KODI

714039

Mbeshtetese  
Clim Tec

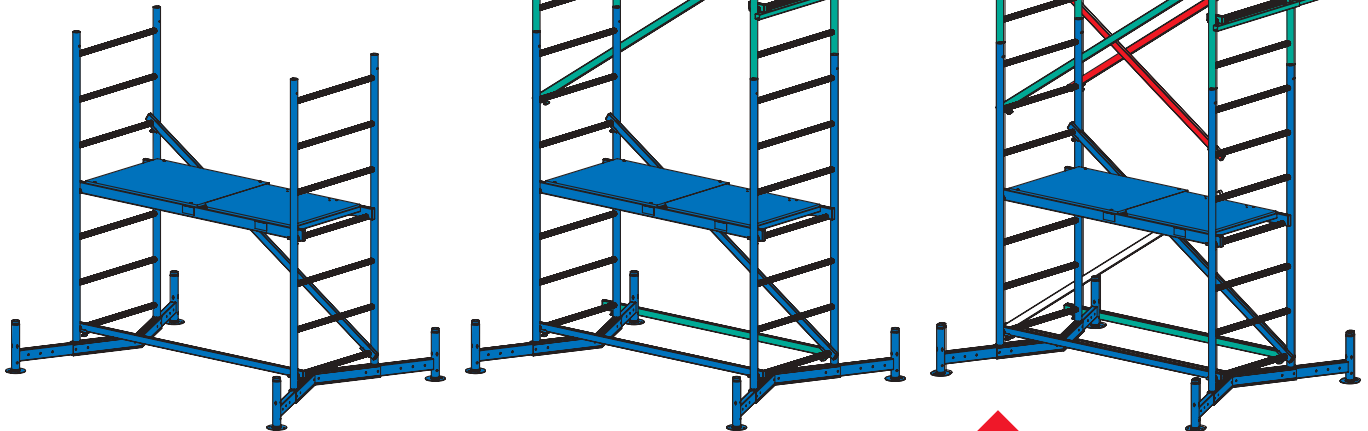

Kodi. 710147

Kodi. 710123

Kodi. 710116

■ Skele Alumini baze Clim Tec	59.000
■ Skele Alumini me nje zgjerim Clim Tec	69.000
■ Skele Alumini me dy zgjerime Clim Tec	79.000

## SET ME RROTA (4COPE)

**MONTO**

Rrota per skelë  
Permasa 125mm CT



KODI 714169

21.500



MADE IN GERMANY



## SKELE ALUMINI STABILO



Ngarkesa maksimale 200 kg/m<sup>2</sup> (grupi i platformës 3) në përputhje me DIN EN 1004. Trari i fortë me bazë çeliku rrit stabilitetin. Rrotat e rregullueshme në lartësi (Ø 150 mm) lejojnë që produkti të përdoret në sipërfaqe të pabarabarta. Platformat varen lehtësisht midis shufrave diagonale (hapi - 25 cm). Operacionet intensive të punës së rirregullimit dhe çmontimit eliminohen. Për lartësitë e punës së produktit prej 7,40 m ose më shumë, mbështetësit e qosheve përfshihen në paketën e dorëzimit.

Gjatësia e seksionit: 2,00 dhe 2,50 m

Gjerësia e seksionit: 0,75 m



KODI

741332

**375.000**

**MADE IN GERMANY**

## PUSHTUES ALUMINI I LEVIZSHEM STABILO / 1X8 -110



Gjatësia maksimale	3 m
Numri i shkallëve	8
Lartësia e punës	3.9 m
Lartësia e platformës	1.9 m
Dimensionet e platformës	60x70 cm
Pesha	63.60 kg

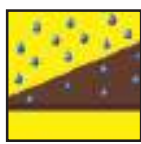

MADE IN GERMANY

KODI 820686

99.500



## SHKALLE ALUMINI ME 2 ELEMENTE CORDA

**WATER RESIST**

KODI	916129	(ca. m)		
ca. 48,0 kg EN 1004 / 150 kg/m <sup>2</sup>	<b>69.900</b>			

## SKELE ALUMINI CORDA 4 MULTIFUNKSIONALE

**MADE IN GERMANY**

KODI	916341	
	<b>65.900</b>	



### SKELE ALUMINI E PALOSESHEME CORDAWH

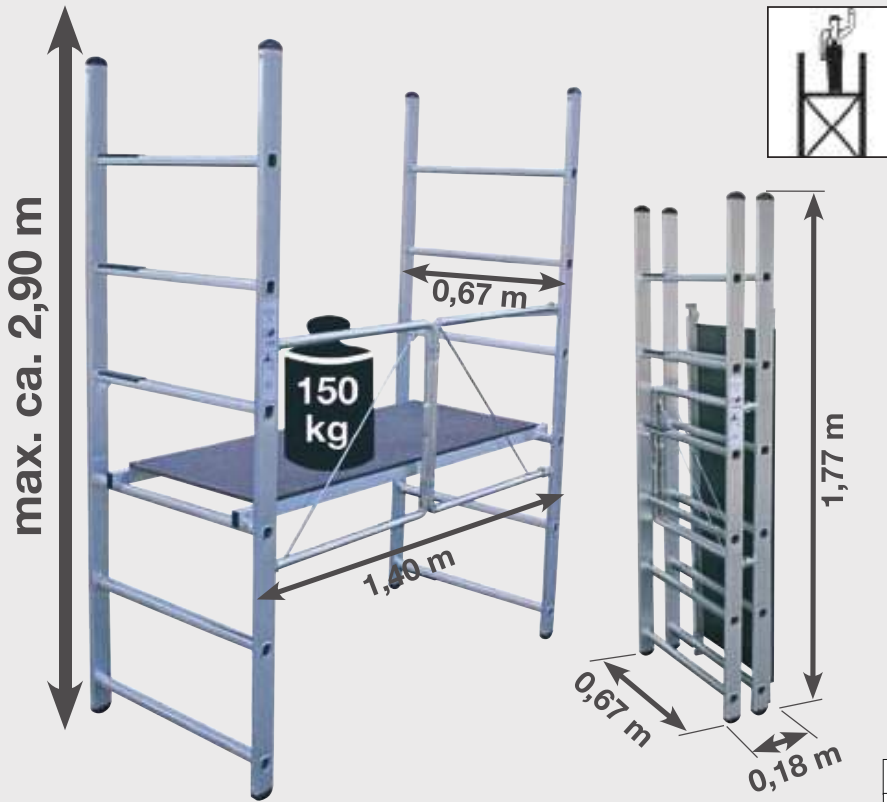

MADE IN GERMANY

KODI 916198  
**29.900**



### SKELE ALUMINI ME RROTA CORDA WH

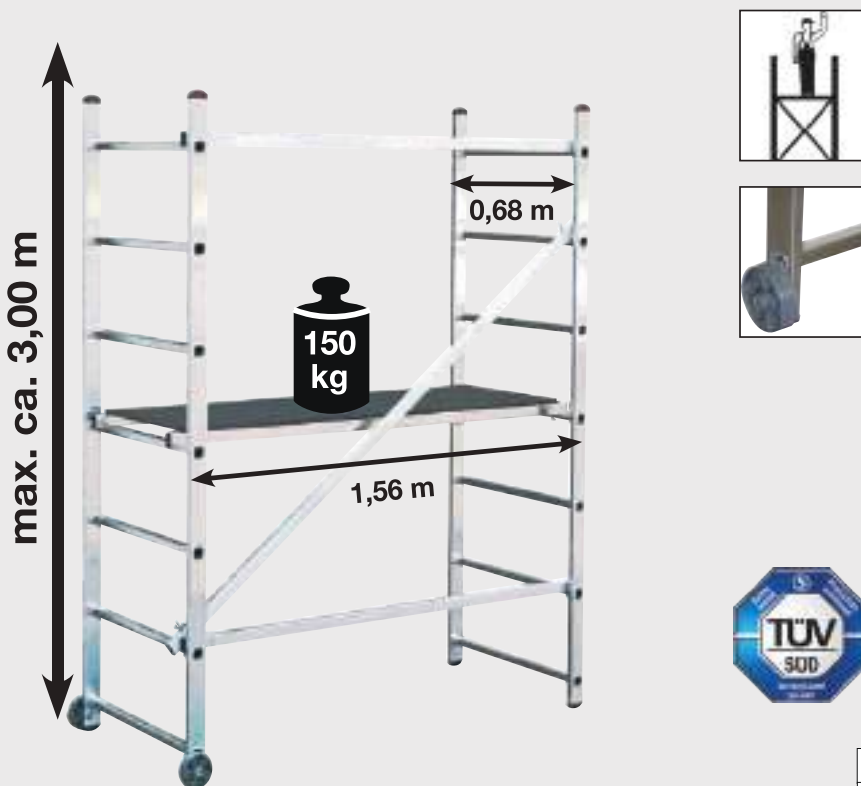

MADE IN GERMANY

KODI 916174  
**26.900**



## SHKALLE ALUMINI FAMILJARE

**FORCE**  
 MACHINERY - TOOLS

- Sistemi i mbylljes së sigurisë me mekanizem metalike.
- Palosja praktike.
- Gati për t'u përdorur në paketim të vetëm elegant.
- Këmbë plastike prej materiali kundër rrëshqitjes.
- Hapat e projektuar special për të shmangur rrëshqitjen.

Kodi		Çmimi
FLH103	me 3 shkelje	<b>2.990</b>
FLH104	me 4 shkelje	<b>3.500</b>
FLH105	me 5 shkelje	<b>3.900</b>
FLH106	me 6 shkelje	<b>4.900</b>
FLH107	me 7 shkelje	<b>5.500</b>



## SHKALLE ALUMINI DOPPLO

**FORCE**  
 MACHINERY - TOOLS

- Sistemi i mbylljes së sigurisë me mekanizem metalike
- Palosja praktike.
- Hapat e projektuar special për të shmangur rrëshqitjen.



Kodi		Çmimi
FLH502	2x2	<b>2.500</b>
FLH503	3x3	<b>3.300</b>
FLH504	4x4	<b>4.300</b>



## SHKALLE ALUMINI TELESKOPIKE

**FORCE**  
 MACHINERY - TOOLS

- Ky sistem i shkallëve të nivelit profesional përmban një dizajn te konvertueshëm që e lejon atë të përdoret deri në 33 hapje te ndryshme.
- Alumini dhe mentesha me dy kunjë ofrojnë stabilitet, ndërsa mekanizmi i hapjes e bën të lehtë rregullimin e lartësisë.
- Peshembajtja 150 kg .
- E përshtatshme për përdorim në industri dhe shtëpi.



Kodi		Çmimi
FLM403	4x3	<b>9.900</b>
FLM404	4x4	<b>11.900</b>
FLM405	4x5	<b>13.500</b>



## SHKALLE ALUMINI INDUSTRIALE DYSHE

- Mentasha mbyllëse e patentuar me një siguresë që mund të hapet me një dorë për përdorim të shpejtë dhe të rehatshëm.
- Stabilizues i gjerë për një stabilitet maksimal.
- Profili anësor të aluminit të përforcuar.
- Shkallët e profilizuara nga të gjitha anët 30 mm të thella 60 mm për një siguri maksimale
- Lidhje të gjata shina anësore.
- E palosshme për ruajtje që kursen hapësirë.
- Tapa rezistente ndaj rrëshqitjes.
- Ripa të forta për qundrueshmeri në lartësi.



Kodi		Çmimi
FLE212	2x12 6.2m	<b>13.500</b>
FLE214	2x14 7.3m	<b>14.900</b>

## SHKALLE ALUMINI INDUSTRIALE TRESHE

- Mentasha mbyllëse e patentuar me një siguresë që mund të hapet me një dorë për përdorim të shpejtë dhe të rehatshëm.
- Stabilizues i gjerë për një stabilitet maksimal.
- Profili anësor të aluminit të përforcuar.
- Shkallët e profilizuara nga të gjitha anët 30 mm të thella 60 mm për një siguri maksimale
- Lidhje të gjata shina anësore.
- E palosshme për ruajtje që kursen hapësirë.
- Tapa rezistente ndaj rrëshqitjes.
- Ripa të forta për qundrueshmeri në lartësi.



Kodi		Çmimi
FLE312	3x12 8.5m	<b>19.900</b>
FLE314	3x14 10m	<b>23.900</b>

## SHKALLE ALUMINI MULTIFUNKSIONALE

- Dimensione kompakte të palosura për transport dhe ruajtje të lehtë.
- Sistemi i thjeshtë i menteshave me klik.
- Shirita për me shumë stabilitet.
- I përshtatshëm për një shumëllojshmëri të gjerë përdorimesh.
- Peshembajtja 150 kg .
- E përshtatshme për përdorim në industri dhe shtëpi.



Kodi		Çmimi
FLM103	4x3	<b>9.900</b>
FLM104	4x4	<b>11.900</b>



## SHKALLE ALUMINI DYSHE ME MEKANIZEM

**FORCE**  
 MACHINERY - TOOLS

- Mentasha mbyllëse e patentuar me një siguresë që mund të hapet me një dorë për përdorim të shpejtë dhe të rehatshëm.
- Stabilizues i gjerë për një stabilitet maksimal.
- Profili anësor të aluminit të përforcuar.
- Shkallët e profilizuara nga të gjitha anët 30 mm të thella për një siguri maksimale
- Lidhje të gjata shina anësore.
- E palosshme për ruajtje që kursen hapësirë.
- Tapa rezistente ndaj rrëshqitjes.



Kodi		Çmimi
FLM308	2x8	<b>9.900</b>
FLM310	2x10	<b>11.900</b>

## SHKALLE FAMILJARE METALIKE (TE KUQE)

**FORCE**  
 MACHINERY - TOOLS

- Sistemi i mbylljes së sigurisë me mekanizem metalike
- Palosja praktike.
- Gati për t'u përdorur në paketim të vetëm elegant.
- Këmbë plastike prej materiali kundër rrëshqitjes.
- Hapat e projektuar special për të shmangur rrëshqitjen.
- Dekorative për përdorim në shtëpi dhe industri.



Kodi		Çmimi
FLS202	me 2 shkelje	<b>2.500</b>
FLS203	me 3 shkelje	<b>3.500</b>
FLS204	me 4 shkelje	<b>3.900</b>
FLS205	me 5 shkelje	<b>4.500</b>
FLS206	me 6 shkelje	<b>4.900</b>

## SHKALLE HEKURI

- Sistemi i mbylljes së sigurisë me mekanizem metalike
- Palosja praktike.
- Këmbë plastike prej materiali kundër rrëshqitjes.
- Hapat e projektuar special për të shmangur rrëshqitjen.

Kodi		Çmimi
SHKH4X3	4x3	<b>5.900</b>
SHKH4X4	4x4	<b>6.500</b>
SHKH4X5	4x5	<b>6.900</b>
SHKH5X5	5x5	<b>7.500</b>
MK	Mekanizem / Ingranazhet për shkalle hekuri	<b>1.250</b>



## SHKALLE DRURI A



Kodi		Çmimi
1404	Me 4 shkelje	<b>6.500</b>
1405	Me 5 shkelje	<b>6.900</b>

## SHKALLE METALIKE FAMILJARE



- Sistemi i mbylljes së sigurisë me mekanizem metalike
- Palosja praktike.
- Gati për t'u përdorur në paketim të vetëm elegant.
- Këmbë plastike prej materiali kundër rrëshqitjes.
- Hapat e projektuar special për të shmangur rrëshqitjen.
- Dekorative per perdorim në shtëpi dhe industri.

Kodi		Çmimi
HLAD09021	me 2 shkelje	<b>2.990</b>
HLAD09031	me 3 shkelje	<b>3.990</b>
HLAD09041	me 4 shkelje	<b>5.500</b>
HLAD09051	me 5 shkelje	<b>6.500</b>
HLAD09061	me 6 shkelje	<b>7.500</b>



## SHKALLE ALUMINI FAMILJARE ME PLATFORME METALIKE



- Sistemi i mbylljes së sigurisë me mekanizem
- Palosja praktike.
- Gati për t'u përdorur në paketim të vetëm elegant.
- Këmbë plastike prej materiali kundër rrëshqitjes.
- Pesha e mbajtjes 150 kg
- Dekorative per perdorim në shtëpi dhe industri.

Kodi		Çmimi
WLD1H03	1x3	<b>3.500</b>
WLD1H04	1x4	<b>4.500</b>
WLD1H05	1x5	<b>5.500</b>
WLD1H06	1x6	<b>5.900</b>
WLD1H07	1x7	<b>6.900</b>



## SHKALLE ALUMINI FAMILJARE ME PLATFORME METALIKE



- Sistemi i mbylljes së sigurisë me mekanizem metalike. • Palosja praktike.
- Peshë e mbajtjes 120 kg



Kodi		Çmimi
WLD3H02	1x2 (Kapaciteti 120kg)	<b>2.900</b>
WLD3H03	1x3 (Kapaciteti 120kg)	<b>3.500</b>
WLD3H04	1x4 (Kapaciteti 120kg)	<b>3.900</b>
WLD3H05	1x5 (Kapaciteti 120kg)	<b>4.900</b>

## SHKALLE ALUMINI FAMILJARE ME PLATFORME METALIKE



- Sistemi i mbylljes së sigurisë me mekanizem metalike. • Palosja praktike.
- Këmbë plastike prej materiali kundër rrëshqitjes.



Kodi		Çmimi
WLD3H06	1x6	<b>5.900</b>
WLD3H07	1x7	<b>6.900</b>
WLD3H08	1x8	<b>7.900</b>

## SHKALLE ALUMINI ME KOMBINIM



- Dimensione kompakte të palosura për transport dhe ruajtje të lehtë.
- Sistemi i thjeshtë i menteshave me klik.
- Shirita për me shumë stabilitet.
- I përshtatshëm për një shumëllojshmëri të gjerë përdorimesh.
- E përshtatshme për përdorim në industri dhe shtëpi.



Kodi		Çmimi
WLD7H43	me kombinim 4x3 (Kapaciteti 150 kg)	<b>9.900</b>



**KARRELE ALUMINI E PALOSSHME**



**5.250**  
**BWR9001**



Kapaciteti  
Permasa

90 kg  
42 x 40x 109 cm

**KARRELE ME PLATFORME ME 4 RROTA**



**12.900**  
**BWR3500**



Kapaciteti

250 kg  
Me 4 rrota

**KARRELE ME ZGJATUES**



**10.500**  
**BWB3000**



Kapaciteti

250 kg  
Me 4 rrota

**KARRELE METALIKE E KUQE**



**5.990**  
**KMK250**



Kapaciteti

250 kg

**KARRELE E PALOSSHME**



**60KGS**

**3.300**  
**WWB9A06**



Kapaciteti  
Permasa

60 kg  
365 x 380 x 960 mm

**KARRELE E PALOSSHME**



**150KGS**

**7.500**  
**WWB9A15**



Kapaciteti  
Permasa

150 kg  
710 x 420 x 950 mm

**KARRELE ME BAZAMENT**



**150KG**

**4.500**  
**WWB1315**



Kapaciteti

150 kg

**KARRELE ME BAZAMENT**



**300KG**

**7.900**  
**WWB1330**



Kapaciteti

300 kg

### KARROCE DORE E KUQE



5.990

KDK2500



Kapaciteti

100 Kg

### KARROCE DORE E GALVANIZUAR



Kodi	Te dhena	Çmimi
BWB7500	200 L	8.500
BWB6500	75 L	3.500

### KARROCE DORE E LYER ME DOREZE ME 2 KOMPONENTE



Load (kg):120 Water Capacity(L) :65

4.500

WWB3F02



Kapaciteti

65Lt

### KARROCE DORE E LYER ME DOREZE ME 2 KOMPONENTE



Load (kg):150 Water Capacity(L) :90

6.500

WWB8F01



Kapaciteti

90 Lt

### KARROCE DORE E LYER ME DOREZE ME 2 KOMPONENTE



Load (kg):150 Water Capacity(L) :90

6.900

WWB8F03



Kapaciteti

90 Lt

### GOMA PER KARROCE DORE



Kodi	Te dhena	Çmimi
WWL83302	Mishi 13x13"	1.200
WWL8301	Pneumatike 16"x4.0-8	1.500
WWL8303	E mbushur me shkume 16"x4.0-8	2.500

### PESHORE ELEKTRONIKE



Kodi	Te dhena	Çmimi
WEC1510	100 Kg	5.500
WEC1531	300 Kg	7.500
WEC1550	500 Kg	9.500

### PESHORE ELEKTRONIKE ME EKTRAN LED



**30kg(66LB)**  
2g graduation

4.950

HESA3303



Per pesha

30 Kg

**PESHORE ELEKTRONIKE ME EKTRAN LED**



**8.500**

**HESA33003**



Per pesha

300 Kg

**PESHORE ELEKTRONIKE ME EKTRAN LED**



**6.690**

**HESA3404**



Per pesha

40 Kg

**RAFT MBAJTES ME 5 SERGJENA MDF**



**3.500**

**WTS1A73**



Kapaciteti  
Permase

175 kg  
1500 x 700 x 300 mm

**RAFT MBAJTES ME 5 SERGJENA MDF**



**3.900**

**WTS1A94**



Kapaciteti  
Permase

175 kg  
1800 x 900 x 400 mm

**RAFT METALIK ME 5 SERGJENA**



**7.900**

**BSR3100**



Permase  
Kapaciteti

200x120x50cm  
50 kg kat

**RAFT METALIK ME 4 SERGJENA**



**2.990**

**BSR1600**



Permase  
Kapaciteti

70x30x150cm  
50 kg kat

**RAFT METALIK ME 5 SERGJENA**



**5.500**

**BSR3001**



Kodi	Te dhena	Çmimi
BSR2100	50 kg kat / 100x45x190 cm	<b>5.500</b>
BSR1900	175 kg kat / 90x40x190 cm	<b>4.500</b>

**RAFT METALIK ME 5 SERGJENA**



Permase  
Kapaciteti

180x90x40cm  
260 kg kat



### TREKENDESH RREZIKU



430x430x430mm

690  
WYJ3A43



Masa: 43x43x43cm

### SINJALIZUES GOME



1150mm

990  
WYJ2A11

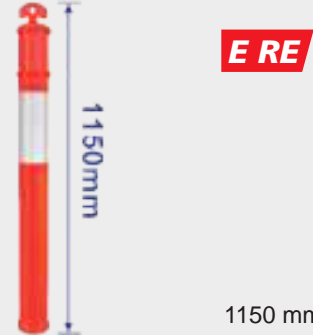

Permasa 1150 mm

### BAZAMENT PER SINJALIZUES GOME



6kg

1.190  
WYJ2A06

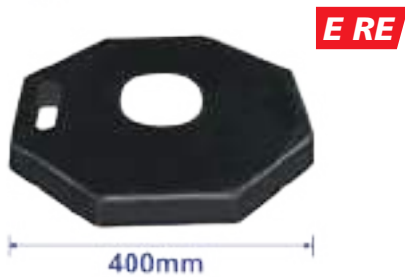

Permasa 6 mm, Kapaciteti 6 kg

### KEND GOME PER SIGURI PARKIMI FOSFORESHENTE



890  
BPP2491



Permasa 80 cm

### KON RRUGESH FOSFORESHENT



990  
BPP2485



Permasa 71 cm

### KON RRUGESH FOSFORESHENT



2.490  
BPP2486



Permasa 71 cm

### KON RRUGESH I HOLLE FOSFORESHENT



990  
BPP2481



Permasa 71 cm

### KON RRUGESH I HOLLE FOSFORESHENT



890  
BPP2480



Permasa 45 cm

**NGADALSUES SHPEJTESIE ME PJESE FOSFORESHENTE**



**E RE**

**2.500**  
**BPP2492**



Permasa  
Pesha

50x35x5 cm  
7.2 kg

**RAMPE E ZEZE GOME**



**E RE**

**3.690**  
**BPP2499**



Permasa

48x32x13 cm

**NGADALSUES SHPEJTESIE GOME FOSFORESHENTE**



**E RE**

**5.500**  
**BPP2489**



Permasa

183 cm

**NGADALSUES SHPEJTESIE GOME FOSFORESHENTE**



**E RE**

**1.990**  
**BPP2490**



Permasa

55 cm

**BARRIERE METALIKE PARKINGU**



**E RE**

**4.500**  
**BPP2496**



Permasa

70x45 cm

**PASQYRE TRAFIKU PER MJEDISE TE JASHTME**



**E RE**

**3.900**  
**BPP2495**



Permasa

60 cm

**PASQYRE TRAFIKU PER MJEDISE TE JASHTME**



**E RE**

**2.900**  
**BPP2494**



Permasa

45 cm

**PASQYRE TRAFIKU PER MJEDISE TE JASHTME**



**E RE**

**2.500**  
**BPP2493**



Permasa

30 cm

**KOKE LOPATE E HARKUAR**



**E RE**

**890**  
SSF610



Permasa 270\*300\*352 mm

**KOKE LOPATE**



**E RE**

**890**  
SSF620

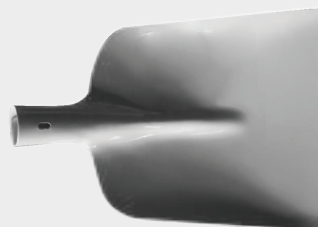

Permasa 250\*270\*325mm

**KOKE LOPATE ME MAJE**



**E RE**

**850**  
SSF615



Permasa 270\*295\*380 mm

**KOKE LOPATE RRUMBULLAKE**



**E RE**

**850**  
SSF605



Permasa 267\*300\*365 mm

**KOKE PER SHAT**



**E RE**



Kodi	Te dhena	Çmimi
SSF686	170 x 190 mm	950
SSF687	190 x 200 mm	990

**KOKE SFURKU**



**E RE**

Kodi	Te dhena	Çmimi
SSF645	217*325*445mm i zi	990
SSF647	217*325*445mm i bardhe	1.100

**KOKE SQEPARI**



**E RE**

**550**  
607517



Permasa 120 x 2.8 cm

**SQEPAR ME BISHT DRURI**



**E RE**

**650**  
607518



Permasa 40 cm



**KOKE KAZME E SHESHTE**

**E RE**
**950**  
**SSF635**

Permasa

100\*275mm / 2 Piruna

**KOKE KAZME ME HARK**

**E RE**
**950**  
**SSF640**

Permasa

110\*285mm

**KREHER METALIK**

**E RE**

Kodi	Te dhena	Çmimi
SSF643	12	850
SSF644	14	890

**KREHER METALIK**

**E RE**



Kodi	Te dhena	Çmimi
SSF641	12 te perdrehur	890
SSF642	14 te perdrehur	990

**KREHER KOPSHTI PER PASTRIM GJETHESH**

**E RE**
**1.290**  
**SSF503**

 Metalik  
 Dhembel 2

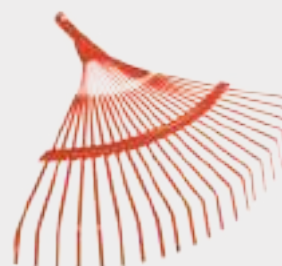
**KREHER KOPSHTI PER PASTRIM GJETHESH**

**E RE**
**590**  
**SSF679**

 Metalik  
 Ngjyra

Portokalli

**BISHTA DRURI**

**E RE**

Kodi	Te dhena	Çmimi
607510	Per lopate / 120 cm	250
607511	Per shat / 120 cm	250
607512	Per kreher / 120 cm	240
607513	Per kazme / 90 cm	250
607514	Per sopate / 90 cm	250
607515	Per fshesa / 120 cm	190
607516	Per sqepar / 40 cm	100

**BISHTA DRURI**

**E RE**

Kodi	Te dhena	Çmimi
SSF828	Per lopate, bel / 120 cm	250
BFT7032	Per fshesa, lecka / 120 cm	150
SSF838	Per fshesa, lecka / 140 cm	320
SSF840	Per fshesa, lecka / 140 cm	330

**ESPOZITOR PER BISHTAT E  
VEGLAVE TE KOPSHTARISE**



**E RE**

**1.990**  
**607522**



Permasa

40 x 40 x 80 cm

**FSHESE E ASHPER, PER  
AMBIENTET E JASHTE**



**E RE**

**750**  
**BFT7031**



Permasa

40 cm x 2.4 cm

**FURCE GOME PASTRIMI**



**E RE**

**790**  
**BFT7030**



Permasa

45 cm x 2.4 cm

**BISHT PER FSHESE /  
LECKE DYSHEMEJE**



**E RE**



Kodi	Te dhena	Çmimi
SSF842	120 x 2.2 cm x 2.5 cm	<b>190</b>
SSF836	120 x 2.5 cm	<b>120</b>

**FSHESE ME DIAMETER  
BISHTI 25 MM**



**E RE**

**290**  
**BFT7001**



Permasa

21 x 3 x 18,5 cm

**FSHESE ME DIAMETER  
BISHTI 25 MM**



**E RE**



Kodi	Te dhena	Çmimi
BFT7002	24x4 x 11 cm	<b>250</b>
BFT7000	26x3,5 x 10,5 cm	<b>220</b>

**FSHESE ME DIAMETER  
BISHTI 25 MM**



**E RE**

**350**  
**BFT7003**



Permasa

27 x 4,7 x 12 cm

**LECKE DYSHEMEJE PAMBUKU**



**E RE**

**590**  
**BFT7033**



Permasa

380 gr

**KOSH MBETURINASH INOXI**

**E RE**
**3.990**
**BTW9050**

 Kapaciteti  
Permasa

 30 L  
29x65 cm

**KOSH MBETURINASH ME RROTA**

**E RE**

Kodi	Te dhena	Çmimi
BTW9053	55x47x96cm / gri	<b>6.900</b>
BTW9055	55x47x96cm / jeshil	<b>6.900</b>

**KOVE ELASTIKE E ZEZE**

**E RE**

Kodi	Te dhena	Çmimi
BHT7986	42 L	<b>990</b>
BHT7987	65 L	<b>1.990</b>

**KOVE LLACI E ZEZE DREJTE-KENDORE ME SHKALLE MATESE**

**E RE**

Kodi	Te dhena	Çmimi
BHT7974	40 L / 71.5x39.5x19cm	<b>990</b>
BHT7976	60 L / 72.5x39x28.5cm	<b>1.190</b>
BHT7978	80 L / 78x55.5x30.3cm	<b>1.590</b>

**KOVE LLACI E ZEZE ME SHKALLE MATESE**

**E RE**

Kodi	Te dhena	Çmimi
BHT7980	40 L	<b>990</b>
BHT7982	65 L	<b>1.150</b>
BHT7984	90 L	<b>1.590</b>

**KOVE LLACI E ZEZE ME SHKALLE MATESE**

**E RE**

Kodi	Te dhena	Çmimi
BHT7970	12 L	<b>390</b>
BHT7971	16 L	<b>450</b>
BHT7972	20 L	<b>590</b>

**FURCE PASTRIMI ME DOREZE PLASTIKE**

**E RE**
**250**
**BFT7007**

Permasa

13,5x6x3,5 cm

**LOPATE FSHESE**

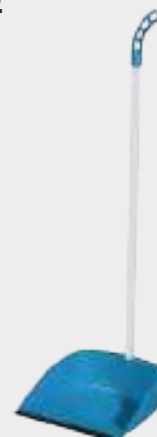
**E RE**
**490**
**BFT7005**

 Bishti  
Permasa e lopates

 70 cm  
26,5x24x11,5 cm



**SET FSHESE DHE LOPATE**



**E RE**

**290**

**BFT7008**



Permasa

24x6,5x3 cm / 29x20x5,5 cm

**SET FSHESE DHE LOPATE**



**E RE**

**650**

**BFT7004**



Permasa

26,5x3x19x75 cm / 26x25x8,5x74 cm

**ZINXHIR PLASTIK TOP**



**8mmx25m**

**E RE**

**2.500**

**WYJ6A08**



Permasa

8 mm x 25m

**ZINXHIR PLASTIK TOP**



**6mmx25m**

**E RE**

**1.790**

**WYJ6A06**



Permasa

6 mm x 25m

**LITAR**



**E RE**



Kodi	Te dhena	Çmimi
WRZ1306	6x20m	<b>290</b>
WRZ1308	8x15m	<b>390</b>
WRZ1310	10x15m	<b>490</b>

**LITAR TOP**



Kodi	Te dhena	Çmimi
WRZ2306	6mm / 1300m	<b>13.900</b>
WRZ2308	8mm / 740m	<b>13.900</b>
WRZ2310	10mm / 470m	<b>13.900</b>
WRZ2312	12mm / 320m	<b>13.900</b>

**SPANGO MURATORI**



**E RE**



Kodi	Te dhena	Çmimi
608018	100 gr	<b>250</b>
608036	120 gr	<b>450</b>
608037	400 gr	<b>790</b>

**ZINXHIR METALIK ME BOBINE METALI 25 KG**



**E RE**



Kodi	Te dhena	Çmimi
608019	3mm / 117.5m	<b>100</b>
608020	4mm / 84.5m	<b>190</b>
608021	5mm / 51.5m	<b>250</b>
608022	6mm / 35.5m	<b>260</b>
608023	8mm / 20.5m	<b>450</b>
608024	10mm / 13m	<b>690</b>

**LITAR RROBE**



**FORCE**  
CHAIN

**E RE**

Kodi	Te dhena	Çmimi
608025	4mm / 1m=7.5gr	15
608026	5mm / 1m=11gr	30
608027	6mm / 1m=16gr	35
608028	8mm / 1m=29gr	35
608029	10mm / 1m=45gr	50
608030	12mm / 1m=65gr	60
608031	14mm / 1m=89gr	70

**LITAR PUSI**



**FORCE**  
CHAIN

**E RE**

Kodi	Te dhena	Çmimi
608032	6mm (45m / 1kg)	25
608033	8mm (27m / 1kg)	45
608034	10mm (18m / 1kg)	60
608035	12mm (15m / 1kg)	90

**QAFORE PER KAFSHE**



**FORCE**  
CHAIN

**E RE**

Kodi	Te dhena	Çmimi
608010	45 x 2.5 cm	490
608011	55 x 2.5 cm	550

**QAFORE LEKURE PER KAFSHE**



**FORCE**  
CHAIN

**E RE**

Kodi	Te dhena	Çmimi
608012	45 x 2.5 cm	1.990
608013	65 x 3 cm	2.200

**TRUPORE RROBE PER KAFSHE**



**FORCE**  
CHAIN

**E RE**

**2.200**  
608014

Permasa

3.5 cm

**QAFORE PER KAFSHE ME THUMBA METALI**



**FORCE**  
CHAIN

**E RE**

**2.500**  
608015

Permasa

70 x 2 cm

**QAFORE PER KAFSH ME ZINXHIR**

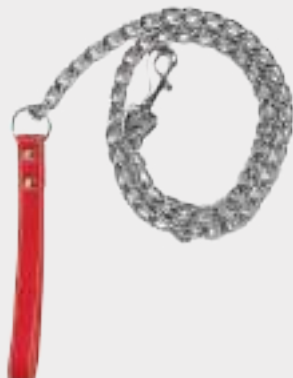

**FORCE**  
CHAIN

**E RE**

**550**  
608016

Permasa

90 cm

**KAPISTRA LOPESH**



**FORCE**  
CHAIN

**E RE**

**490**  
608017



**ELEKTRIKE**

**HIDRAULIKE**



### Ndricues kantieri LED kundra ujit



Kodi	Fuqia	Drite natyrale	Ndricimi	Rrezja	Cmimi
BLF1005	10 W	4000 K	800 Lm	120	590
BLF1010	20 W	4000 K	1600 Lm	120	650
BLF1015	30 W	4000 K	2400 Lm	120	990
BLF1020	50 W	4000 K	4000 Lm	120	1450
BLF1025	100 W	4000 K	8000 Lm	120	2590
BLF1030	150 W	4000 K	12000 Lm	120	4.990
BLF1035	200 W	4000 K	16000 Lm	120	6.990
BLF1040	300 W	4000 K	24000 Lm	120	11.500



### Ndricues kantieri LED kundra ujit, me sensor levizje



Kodi	Fuqia	Drite natyrale	Ndricimi	Cmimi
BLF1910	10 W	4000 K	800 Lm	1.790
BLF1920	20 W	4000 K	1600 Lm	1.990
BLF1930	30 W	4000 K	24000 Lm	2.390
BLF1940	150 W	4000 K	4000 Lm	2.790
BLF1950	100 W	4000 K	8000 Lm	3.990



### Ndricues kantieri LED me panel diellor



Kodi	Fuqia	Ndricimi	Cmimi
BLF2350	100 W	1000 Lm	7.500
BLF2550	200 W	2000 Lm	11.900
BLF2650	300 W	2500 Lm	17.500
BLF2750	400 W	3500 Lm	19.900



### Ndricues LED per rruge, kundra ujit, me panel diellor



Kodi	Fuqia	Ndricimi	Cmimi
BLF3100	100 W	2800 Lm	19.000
BLF3550	150 W	750 Lm	6.990
BLF3600	300 W	1000 Lm	11.900



**Ndricues kantieri LED**



**BLF1500**

- Kundra ujit
- Ndricimi: 800 Lm
- Drita natyrale 4000 K



Çmimi  
**990**

**Ndricues kantieri LED 50 W**



**BLF2150**

- Me panel dhe sensor levizje
- Telekomande, Kohemates



Çmimi  
**4.990**

**Ndricues sigurie LED 6.5 W**



**BLF4000**

- Kundra ujit
- Me panel solar 5.5V/1.8W
- Ndricimi: 1000 Lm



Çmimi  
**2.990**

**Ndricues kopeshti me panel**



**BLF4100**

- Permase: 13x78 cm
- Ndricimi: 200 Lm
- IP65



Çmimi  
**4.990**

**Ndricues kopeshti me panel**



**BLF4130**

- Permase: 12x15x32 cm
- Ndricimi: 120 Lm
- IP44



Çmimi  
**2.990**

**Ndricues kopeshti dysh**



**BLF4110**

- Permase: 15x18x36 cm
- Ndricimi: 120 Lm
- IP44
- Me panel



Çmimi  
**3.690**

**Ndricues kopeshti dysh**



**BLF4120**

- Permase: 13x18x72 cm
- Ndricimi: 250 Lm
- IP44
- Me panel



Çmimi  
**4.900**





Deklarata jone per ju:

**Fuqizoni të dashurit tuaj me dritë dhe ngrohtësi përmes ndriçimit.**



Në vitin 2016, WELLMAX u bë partneri i parë strategjik global i SAMSUNG, aleanca është kontraktuar nga MOU nje memorandum strategjik gjithëpërfshirës e nënshkruar për të zhvilluar produktet e ndricimit LED.

Cilësia premium e Samsung LED dhe aftësia unike e kërkimit dhe zhvillimit të WELLMAX jane bashkuar per ta bere produktin e tyre unik dhe te pa konkurueshem.



**Te paret ne bote!**

Samsung Electronics, furnizuesi më i madh në botë i gjysmëpërçuesve, nënshkroi një marrëveshje gjithëpërfshirëse të partneritetit strategjik me WELLMAX.

MOU identifikon WELLMAX si një nga partneret e parë global te SAMSUNG-ut per produktet e ndricimit.



**Influence globale!**

Marrëdhënia e SAMSUNG dhe WELLMAX u thellua gjatë viteve në fronte të shumta. WELLMAX ka qenë krenar që ka inkorporuar teknologjinë më të re të çipeve LED të SAMSUNG për të zhvilluar produkte. Në vitin 2016, produktet e WELLMAX u ekspozuan si shembull inovacioni në standat e SAMSUNG në Gjermani.



**Një e ardhme e ndritur së bashku!**

E nxitur nga globalizimi, konkurrenca brenda industrisë LED po bëhet gjithnjë e më e ashpër. Me teknologjinë e çipit LED të SAMSUNG dhe mbrojtjen e IP-së, WELLMAX mund të garantojë cilësi dhe besueshmëri të produktit për klientët e tij.



**Bashkëpunim i përkushtuar!**

WELLMAX do të vazhdojn të zgjeroje gamen e produkteve me teknologjine SAMSUNG LED, duke u ofruar klientëve në mbarë botën produkte me cilësi të lartë dhe të besueshme per klientet.

Ne do të shtrijmë produktet dhe mbështetjen tonë profesionale në më shumë vende, duke sjellë dritë dhe ngrohtësi përmes ndriçimit.



Qëllimi i WTC është t'u shërbejë më mirë klientëve tanë të çmuar dhe t'i ndihmojë ata të mbajnë një rritje të fortë të biznesit. Mundësuar nga 3 superfuqite tona:



Ekipi i R&D gjithmone i gatshem për të ekzekutuar dizajn unik, testimin e certifikimin si dhe prodhimin e artikujve te rinj konkurues dhe gjithone duke permbushur nevojat e klienteve.



Trajnime te vazhdueshme te bashkpuntoreve tone ne dy aspekte si: know-how dhe show-how per te permiresuar vazhdimisht cilesine e sherbimit dhe produktit.



Bashkpunimi me SAMSUNG dhe labororet e njohur te certifikimit SGS dhe DEGRA bejne qe produktet tona te kalojne cdo certifikim global dhe ti sigurojne klienteve garancine maksimale.

Certifikime:





## Lambe LED-PRO SERIES



Kodi	Fuqia	Voltazhi	Intensiteti	Ndricimi	Çmimi
A60CL096	9 W	176-264V	810 lumen	6500 K	<b>190</b>
A60CL094	9 W	176-264V	810 lumen	4000 K	<b>190</b>

Kodi	Fuqia	Voltazhi	Intensiteti	Ndricimi	Çmimi
A60CL126	12 W	176-264V	1160 lumen	6500 K	<b>250</b>

Kodi	Fuqia	Voltazhi	Intensiteti	Ndricimi	Çmimi
A60CL156	15 W	176-264V	1521 lumen	6500 K	<b>290</b>

## Lambe LED te erresueshme



- Niveli i përsosur i ndriçimit nga 15-100%.
- Dritë e qetë pa zhurmë.
- Kursimi i energjisë elektrike dhe kursimi i parave.
- Trupi: Alumini i veshur me plastikë që përçon nxehtësinë.
- Përshtatet me te gjith modelet e pajisjeve per dimmer

Kodi	Fuqia	Voltazhi	Intensiteti	Ndricimi	Çmimi
ADIM096	9 W	176-264V	810 lumen	6500 K	<b>290</b>

## Lambe LED me sensor



- Sensori i integruar i dritës dhe sensor i lëvizjes.
- Ndjeshmëria e dritës 360°.
- Konsumi i ulët i energjisë dhe stabilitet i lartë.
- I ndjeshëm ndaj dritës natyrore të ambientit, performancë e saktë
- Ofrohen zgjidhje të shumta ndijuese për t'iu përshtatur skenarëve të ndryshëm

Kodi	Fuqia	Voltazhi	Intensiteti	Ndricimi	Çmimi
ABLSEN096	9 W	176-264V	810 lumen	6500 K	<b>590</b>

## Lambe LED me tre ndricime



- 3 opsione ngjyrash në një llambë.
- Memorie inteligjente e integruar.
- Lehtë për t'u instaluar dhe nuk ka nevojë të ndryshoni çelësin tuaj ekzistues.
- Zëvendësoni direkt llambën e vjetër, pa patur nevojën e pajisjeve shtese.
- Trupi: Plastikë e re që përçon nxehtësinë

Kodi	Fuqia	Voltazhi	Intensiteti	Ndricimi	Çmimi
ACLDIM096	9 W	176-264V	810 lumen	3000 K 4000 K 6500 K	<b>250</b>

## Llambe LED ECO LITE



- Kursim 5% i energjisë - i njëjti fluks ndriçues me një fuqi më të ulët.
- Pa luhatje te drites dhe ne fuqi te ulet.
- Trup shumë më i vogël.

Kodi	Fuqia	Voltazhi	Intensiteti	Ndricimi	Çmimi
HTECO286	28 W	176-264V	3000 lumen	6500 K	<b>590</b>
HTECO386	38 W	176-264V	4050 lumen	6500 K	<b>790</b>
HTECO456	45 W	176-264V	5000 lumen	6500 K	<b>950</b>

## Llambe LED per spote



Kodi	Fuqia	Voltazhi	Intensiteti	Ndricimi	Çmimi
GUCL046	4 W	176-264V	340 lumen	6500 K	<b>190</b>
GUCL044	4 W	176-264V	360 lumen	4000 K	<b>190</b>
GUCL076	7 W	176-264V	595 lumen	6500 K	<b>220</b>
GUCL074	7 W	176-264V	630 lumen	4000 K	<b>220</b>



Kodi	Fuqia	Voltazhi	Intensiteti	Ndricimi	Çmimi
GUCLDIM0656	6.5 W	176-264V	585 lumen	6500 K	<b>290</b>

## Llambe LED per ndriçues magazine



Kodi	Fuqia	Voltazhi	Intensiteti	Ndricimi	Çmimi
T8GL186	18 W 120 CM	176-264V	1850 lumen	6500 K	<b>360</b>
T8GLHB186	18 W 120 CM	176-264V	2520 lumen	6500 K	<b>390</b>
T8GLHB226	22 W 150 CM	176-264V	3080 lumen	6500 K	<b>490</b>

## Shirit Led



- Permasat: 120 led/m - 5000 mm x 8 mm x 1.3 mm
- Permasat: 240 led/m - 5000 mm x 12 mm x 1.3 mm

Kodi	Fuqia	Voltazhi	LED	Intensiteti	Ndricimi	Çmimi
SLV121206	8 W/M	12 V	120	1000 lumen	6500 K	<b>250</b>
SLV121204	8 W/M	12 V	120	1000 lumen	4000 K	<b>250</b>
SLV122406	14.5 W/M	12 V	240	1500 lumen	6500 K	<b>380</b>
SLV122404	14.5 W/M	12 V	240	1500 lumen	4000 K	<b>380</b>
SLV241206	8 W/M	24 V	120	1000 lumen	6500 K	<b>250</b>
SLV241204	8 W/M	24 V	120	1000 lumen	4000 K	<b>250</b>
SLV242406	14.5 W/M	24 V	240	1500 lumen	6500 K	<b>380</b>
SLV242404	14.5 W/M	24 V	240	1500 lumen	4000 K	<b>380</b>

## Spot inkaso LED



Kodi	Fuqia	Voltazhi	Ø	Intensiteti	Ndricimi	Çmimi
UDRSD066	6 W	176-264V	ø108	330 lumen	6500 K	<b>590</b>
UDRSD096	9 W	176-264V	ø135	540 lumen	6500 K	<b>690</b>
UDRSD126	12 W	176-264V	ø158	720 lumen	6500 K	<b>850</b>
UDRSD186	18 W	176-264V	ø206	1250 lumen	6500 K	<b>950</b>
UDRSD246	24 W	176-264V	ø282	1680 lumen	6500 K	<b>1.500</b>
Kodi	Fuqia	Voltazhi	<-->	Intensiteti	Ndricimi	Çmimi
UPRBG486	48 W	176-264V	60x60	4800 lumen	6500 K	<b>2.200</b>

## Spot jashte muri LED SUNLIGHT



Kodi	Fuqia	Voltazhi	Ø	Intensiteti	Ndricimi	Çmimi
UDSSD126	12 W	176-264V	ø175	720 lumen	6500 K	<b>990</b>
UDSSD186	18 W	176-264V	ø220	1250 lumen	6500 K	<b>950</b>
UDSSD246	24 W	176-264V	ø295	1680 lumen	6500 K	<b>1.500</b>

### Plastic series

Kodi	Fuqia	Voltazhi	Ø	Intensiteti	Ndricimi	Çmimi
UDSSR186	18 W	176-264V	ø226	1850 lumen	6500 K	<b>650</b>
UDSSR246	24 W	176-264V	ø226	2500 lumen	6500 K	<b>750</b>

## Ndricues LED i gjate



Kodi	Fuqia	Voltazhi	<-->	Intensiteti	Ndricimi	Çmimi
UBWCL246	24 W	176-264V	90cm	2160 lumen	6500 K	<b>890</b>
UBWCL366	36 W	176-264V	120cm	3240 lumen	6500 K	<b>1.200</b>
UBWCL426	42 W	176-264V	150cm	3780 lumen	6500 K	<b>1.500</b>

## Prozhektor LED/PIR



Kodi	Fuqia	Voltazhi	Intensiteti	Ndricimi	Çmimi
UFLFX10	10 W	176-264V	900 lumen	6500 K	<b>650</b>
UFLFX30	30 W	176-264V	2700 lumen	6500 K	<b>900</b>
UFLFX50	50 W	176-264V	4500 lumen	6500 K	<b>1.200</b>
UFLFX100	100 W	176-264V	9000 lumen	6500 K	<b>2.200</b>
UFLFX150	150 W	176-264V	13500 lumen	6500 K	<b>2.900</b>
UFLFX200	200 W	176-264V	18000 lumen	6500 K	<b>3.900</b>

### PIR series

Kodi	Fuqia	Voltazhi	Intensiteti	Ndricimi	Çmimi
UFLFX10SQ	10 W	176-264V	900 lumen	6500 K	<b>1.500</b>
UFLFX30SQ	30 W	176-264V	2700 lumen	6500 K	<b>1.700</b>
UFLFX50SQ	50 W	176-264V	4500 lumen	6500 K	<b>1.900</b>



**Llambe LED SMD**

**9**  
watt



220 V



E27



810 lumen

ED-1044 **6500 K**

ED-1045 **4000 K**

ED-1046 **3000 K**

Çmimi  
**100**

**Llambe LED SMD**

**15**  
watt



220 V



E27



1350 lumen

ED-1066 **6500 K**

ED-1067 **4000 K**

ED-1068 **3000 K**

Çmimi  
**200**

**Llambe LED SMD**

**5**  
watt



220 V



E14



450 lumen

ED-1024 **6500 K**

ED-1025 **4000 K**

ED-1026 **3000 K**

Çmimi  
**150**

**Llambe LED SMD**

**7**  
watt



220 V



GU10



420 lumen

ED-66 **6500 K**

ED-67 **4000 K**

ED-68 **3000 K**

Çmimi  
**180**

**Llambe LED SMD**

**5**  
watt



220 V



E27



ED-1021 **4000 K**

ED-1022 **3000 K**

Çmimi  
**250**

**Llambe LED SMD**

**6**  
watt



220 V



E27



450 lumen

ED-1316 **4000 K**

ED-1315 **2700 K**

Çmimi  
**350**

**Llambe LED SMD**

**6500 K**



220 V



E27



**20** watt  1700 lumen

**30** watt  2300 lumen

Çmimi

ED-2930 **20 w** **350**

ED-2932 **30 w** **450**

**Llambe LED SMD**

**6500 K**



220 V



E27



**40** watt  3600 lumen

**50** watt  4500 lumen

Çmimi

ED-2938 **40 w** **720**

ED-2940 **50 w** **850**

**Spot inkaso**

**3** watt

70 mm / 225 lumen

ED-1135 (6500 K)

220 V

OFF ON  
5000x

**LED**  
taiwan

IP23



Çmimi  
**320**

**Spot inkaso**

**6** watt

105 mm / 450 lumen

ED-1138 (6500 K)

220 V

OFF ON  
5000x

**LED**  
taiwan

IP23



Çmimi  
**420**

**Spot inkaso**

**9** watt

125 mm / 675 lumen

ED-1141 (6500 K)

220 V

OFF ON  
5000x

**LED**  
taiwan

IP23



Çmimi  
**520**

**Spot inkaso**

**12** watt

155 mm / 960 lumen

ED-1154 (6500 K)

220 V

OFF ON  
5000x

**LED**  
taiwan

IP23



Çmimi  
**580**

**Spot inkaso**

**15** watt

180 mm / 1125 lumen

ED-1134 (6500 K)

220 V

OFF ON  
5000x

**LED**  
taiwan

IP23



Çmimi  
**680**

**Spot inkaso**

**18** watt

200 mm / 1350 lumen

ED-1148 (6500 K)

220 V

OFF ON  
5000x

**LED**  
taiwan

IP23



Çmimi  
**750**

**Spot inkaso**

**24** watt

270 mm / 1800 lumen

ED-1163 (6500 K)

220 V

OFF ON  
5000x

**LED**  
taiwan

IP23



Çmimi  
**1.300**

**Spot inkaso**

**6** watt

72 mm / 450 lumen

ED-6005 (6500 K)  
ED-6007 (3000 K)

220 V

OFF ON  
5000x

**LED**  
taiwan

IP23



Çmimi  
**200**

**Spot jashte muri**

**6** watt

120 mm / 450 lumen

ED-1178 (6500 K)

220 V

OFF ON  
5000x

**LED**  
taiwan

IP23



Çmimi  
**620**

**Spot jashte muri**

**12** watt

175 mm / 1125 lumen

ED-1182 (6500 K)

220 V

OFF ON  
5000x

**LED**  
taiwan

IP23



Çmimi  
**900**

**Spot jashte muri**

**18** watt

225 mm / 1350 lumen

ED-1188 (6500 K)

220 V

OFF ON  
5000x

**LED**  
taiwan

IP23



Çmimi  
**990**

**Spot jashte muri**

**24** watt

280 mm / 1800 lumen

ED-1192 (6500 K)

220 V

OFF ON  
5000x

**LED**  
taiwan

IP23



Çmimi  
**1.300**

**Shirit LED**

**120**  
LED

1100 lumen



12 V



IP23



ED-2030 (6500 K)

ED-2032 (4000 K)



Çmimi  
**600**

**Shirit LED**

**240**  
LED

1260 lumen



12 V



IP23

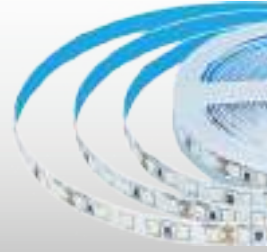

ED-2035 (6500 K)

ED-2037 (4000 K)



Çmimi  
**1.200**

**Shirit LED COB**

**300**  
LED

10 W / m



12 V



IP23



ED-2026 (6500 K)

ED-2026 (4000 K)

Çmimi  
**1.300**

**Shirit LED**

**120**  
LED

750 lumen / m



220 V



IP65



ED-2060 (6500 K)

ED-2062 (4000 K)

Çmimi  
**300**

**Shirit LED RGB**

**50**  
LED

14.4 W / m - 720 lumen



12 V



IP23



ED-2160 (RGB)

Çmimi  
**900**

**Set shirit LED RGB**

**50**  
LED

14.4 W / m - 720 lumen



12 V



IP23



ED-1565 (RGB)

Çmimi  
**1.500**

**Transformatore LED**



220 V



IP23



ED-1564

Kodi	Tensioni	Fuqia	Amperazhi	Çmimi
ED-1537	12 V	60 W	5 A	<b>750</b>
ED-1540	12 V	100 W	85 A	<b>990</b>
AU-1543	12 V	120 W	10 A	<b>1.050</b>
ED-1546	12 V	150 W	12.5 A	<b>1.250</b>
AU-1550	12 V	200 W	16.5 A	<b>1.650</b>
AU-1554	12 V	250 W	21 A	<b>1.800</b>
ED-1555	12 V	320 W	27 A	<b>2.000</b>
AU-1557	12 V	360 W	30 A	<b>2.200</b>
ED-1564	12 V-24	576 W	24 A	<b>1.500</b>



**Prozhektor LED**

**10**  
watt

800 lumen

ED-110 (6500 K)



**LED**  
taiwan



Çmimi  
**790**

**Prozhektor LED**

**20**  
watt

1600 lumen

ED-115 (6500 K)



**LED**  
taiwan



Çmimi  
**990**

**Prozhektor LED**

**30**  
watt

2400 lumen

ED-120 (6500 K)



**LED**  
taiwan



Çmimi  
**1.100**

**Prozhektor LED**

**50**  
watt

4000 lumen

ED-125 (6500 K)



**LED**  
taiwan



Çmimi  
**1.300**

**Prozhektor LED**

**100**  
watt

8000 lumen

ED-135 (6500 K)



**LED**  
taiwan



Çmimi  
**2.300**

**Prozhektor LED**

**150**  
watt

12000 lumen

ED-140 (6500 K)



**LED**  
taiwan



Çmimi  
**3.400**

**Prozhektor LED**

**200**  
watt

16000 lumen

ED-145 (6500 K)



**LED**  
taiwan



Çmimi  
**4.300**

**Prozhektor LED**

**300**  
watt

24000 lumen

ED-150 (6500 K)



**LED**  
taiwan



Çmimi  
**6.200**

**Prozhektor LED me sensor**

**10**  
watt

800 lumen

ED-113 (6500 K)



**LED**  
taiwan



Çmimi  
**1.600**

**Prozhektor LED me sensor**

**30**  
watt

2400 lumen

ED-123 (6500 K)



**LED**  
taiwan



Çmimi  
**2.200**

**Prozhektor LED me sensor**

**50**  
watt

4000 lumen

ED-128 (6500 K)



**LED**  
taiwan



Çmimi  
**3.000**

**Prozhektor LED me sensor**

**100**  
watt

8000 lumen

ED-138 (6500 K)



**LED**  
taiwan



Çmimi  
**4.300**

1  
2  
3  
4  
5  
6  
7  
8  
9  
10

**Ndricules magazine**

**18**  
watt

60 cm / 1440 lumen

ED-1630 (6500 K)



**LED**  
taiwan



Çmimi  
**500**

**Ndricules magazine**

**36**  
watt

120 cm / 2880 lumen

ED-1640 (6500 K)



**LED**  
taiwan



Çmimi  
**690**

**Ndricules magazine**

**54**  
watt

120 cm / 4320 lumen

ED-1650 (6500 K)



**LED**  
taiwan



Çmimi  
**1.200**

**Ndricules magazine**

**72**  
watt

120 cm / 5760 lumen

ED-1655 (6500 K)



**LED**  
taiwan



Çmimi  
**1.500**

**Spot inkaso**

**40**  
watt

60x60 cm / 3200 lumen

ED-5000 (6500 K)



**LED**  
taiwan



Çmimi  
**1.600**

**Kase per spot inkaso**

60x60 cm

ED-3600

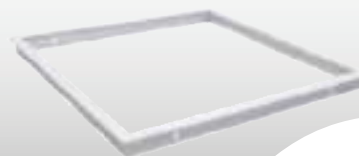

Çmimi  
**450**

**Spot jashte muri**

**6**  
watt

120x120 mm / 450 lumen

ED-1206 (6500 K)



**LED**  
taiwan



Çmimi  
**720**

**Spot jashte muri**

**12**  
watt

175x175 mm / 900 lumen

ED-1230 (6500 K)



**LED**  
taiwan



Çmimi  
**990**

**Spot jashte muri**

**18**  
watt

225x225 mm / 1350 lumen

ED-1210 (6500 K)



**LED**  
taiwan



Çmimi  
**1.100**

**Spot jashte muri**

**24**  
watt

280x280 mm / 1800 lumen

ED-1220 (6500 K)



**LED**  
taiwan



Çmimi  
**1.500**

**Sensor muzgu**

**10**  
Amper

ED-3318



Çmimi  
**550**

**Sensor levizje**

**1200**  
watt

ED-3310



Çmimi  
**1.100**

**Kase spoti alumin**



ED-2140 gold  
ED-2141 rose gold  
ED-2142 silver  
ED-2143 e zeze  
ED-2144 e bardhe

Çmimi  
**250**

**Kase spoti alumin**



ED-2145 gold  
ED-2146 rose gold  
ED-2147 silver  
ED-2148 e zeze  
ED-2149 e bardhe

Çmimi  
**250**

**Kase spoti alumin**



ED-2150 gold  
ED-2151 rose gold  
ED-2152 silver  
ED-2153 e zeze  
ED-2154 e bardhe

Çmimi  
**400**

**Ndricules jashte muri me sensor**



ED-4000

220 V  
IP23  
2xE27

Çmimi  
**1.100**

**Ndricules jashte muri me sensor**



18 watt  
ED-4020 (6500 K)

220 V  
OFF ON  
5000x  
LED taiwan  
IP23

Çmimi  
**1.500**

**Ndricules jashte muri me sensor**



18 watt  
ED-1186 (6500 K)

220 V  
OFF ON  
5000x  
LED taiwan  
IP23

Çmimi  
**1.800**

**Ndricules pasqyre**



6 watt  
ED-2122 (6500 K)

220 V  
OFF ON  
5000x  
LED taiwan  
IP23

Çmimi  
**2.700**

**Ndricules pasqyre**



6 watt  
ED-2125 (6500 K)

220 V  
OFF ON  
5000x  
LED taiwan  
IP23

Çmimi  
**2.800**

**Ndricules pasqyre**



6 watt  
ED-2130 (6500 K)

220 V  
OFF ON  
5000x  
LED taiwan  
IP23

Çmimi  
**2.800**

**Sahat elektronik**



ED-4115

220 V  
IP23

Çmimi  
**1.500**

**Kabull interneti CAT6 UTP**

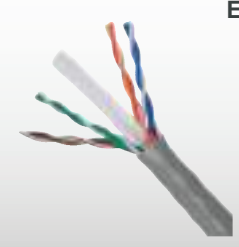

305 M  
ED-500-GRI

Çmimi  
**25**

**Portollambe GU10**



ED-770

220 V  
IP23

Çmimi  
**50**



**Ndricues muri**

**6**  
watt



ED-6051 **3000 K**

ED-6056 **3000 K**

ED-6061 **3000 K**



Çmimi  
**1.300**

**Ndricues muri**



ED-633 **E zeze**

ED-633-2 **Gri**

ED-633-1 **E bardhe**



Çmimi  
**600**

**Ndricues muri**



ED-8400



Çmimi  
**250**

**Ndricues kopshti**



ED-7030



Çmimi  
**1.700**

**Ndricues kopshti**



ED-7035



Çmimi  
**1.900**

**Ndricues kopshti**



ED-7810



Çmimi  
**1.100**

**Ndricues kopshti**



ED-8100 **E zeze**

ED-8120 **Baker**

ED-8140 **E bardhe**



Çmimi  
**820**

**Ndricues kopshti**



ED-8105 **E zeze**

ED-8125 **Baker**

ED-8145 **E bardhe**



Çmimi  
**820**

**Ndricues kopshti**



ED-8115 **E zeze**

ED-8135 **Baker**

ED-8155 **E bardhe**



Çmimi  
**820**

**Ndricues kopshti**



Çmimi

ED-7250 (41cm) **1.300**

ED-7275 (55cm) **1.600**

ED-7300 (62cm) **1.800**

ED-7350 (80cm) **2.200**



**Ndricues kopshti**



Çmimi

ED-7600 (41cm) **1.200**

ED-7650 (55cm) **1.500**

ED-7675 (62cm) **1.700**

ED-7700 (80cm) **2.200**

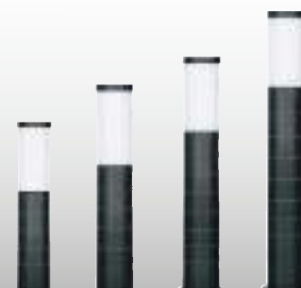

**601082**

 Çmimi  
**3.300**
**Baladeze me 4 priza**

25m 3x1.5mm plastike

**601083**

 Çmimi  
**5.500**
**Baladeze me 4 priza**

50m 3x1.5mm plastike

**601084**

 Çmimi  
**4.500**
**Baladeze metalike**

Me 4 priza 20m 3x2.5mm

**601108**

 Çmimi  
**6.900**
**Baladeze metalike**

Me 4 priza 40m 3x2.5mm

**601086**

 Çmimi  
**1.690**
**Baladeze portabel**

10m 3x1.5mm

**601087**

 Çmimi  
**4.500**
**Baladeze qe terhiqet**

14+2m 3x1.5

**601092**

 Çmimi  
**790**
**Llambe pune 5m, 2x0.75**

Celes dhe varese metalike, poc 60W

**601097**

 Çmimi  
**250**
**Adaptor**

1x16A ne 3x16A

**Zgjatues me 3 priza (i bardhe)**

Kodi	Te dhena	Çmimi
601098	2m / 3x1.5mm	450
601099	3m / 3x1.5mm	550
601100	5m / 3x1.5mm	690

**Zgjatues me 5 priza (i bardhe)**

Kodi	Te dhena	Çmimi
601101	2m / 3x1.5mm	490
601102	3m / 3x1.5mm	590
601103	5m / 3x1.5mm	790

**Zgjatues me 3 priza dhe celes (i bardhe)**

Kodi	Te dhena	Çmimi
601104	3m / 3x1.5mm	590
601105	5m / 3x1.5mm	790

**Zgjatues me 5 priza dhe celes (i bardhe)**

Kodi	Te dhena	Çmimi
601074	2m / 3x1.5mm	550
601106	3m / 3x1.5mm	650
601107	5m / 3x1.5mm	890

**Baladeze me 4 priza kabull i zi me mbrojtje termale IP20 pa kapak**



Kodi	Te dhena	Çmimi
5910000	Bosh, per 50m kabell	<b>1.590</b>
5910020	20m / 3x1.5mm	<b>3.500</b>
5910030	30m / 3x1.5mm	<b>4.900</b>
5910040	40m / 3x1.5mm	<b>5.500</b>

**Baladeze me 4 priza kabull i zi me mbrojtje termale IP20 pa kapak**



Kodi	Te dhena	Çmimi
5910021	20m / 3x2.5mm	<b>4.900</b>
5910031	30m / 3x2.5mm	<b>5.900</b>
5910041	40m / 3x2.5mm	<b>6.900</b>

**Baladeze me 4 priza i zi me mbrojtje termale dhe kapak izolimi nga lageshtia**



Kodi	Te dhena	Çmimi
5940000	Bosh, per 50m kabell	<b>1.950</b>
5940020	20m / 3x1.5mm IP44	<b>3.900</b>
5940030	30m / 3x1.5mm IP44	<b>4.900</b>
5940040	40m / 3x1.5mm IP44	<b>5.900</b>

**Baladeze me 4 priza i zi me mbrojtje termale dhe kapak izolimi nga lageshtia**



Kodi	Te dhena	Çmimi
5940021	20m / 3x2.5mm IP44	<b>4.500</b>
5940031	30m / 3x2.5mm IP44	<b>5.900</b>
5940041	40m / 3x2.5mm IP44	<b>6.900</b>

**Baladeze me 4 priza i zi me mbrojtje termale dhe kapak izolimi nga lageshtia METALIKE**



Kodi	Te dhena	Çmimi
5940100	Bosh, per 50m kabell	<b>2.990</b>
5940141	40m x 3x2.5 IP44	<b>8.500</b>

**Prizë Murale e Gomuar e Zezë**



Kodi	Te dhena	Çmimi
5510000	1 vënde	<b>290</b>
5520000	2 vënde	<b>450</b>
5530000	3 vënde	<b>450</b>
5540000	4 vënde	<b>750</b>

**Zgjatues kabelli me celesme mbrojtje femijesh 3x1.5mm**



Kodi	Te dhena	Çmimi
220600031	3 priza / 3m kabell	<b>890</b>
220400031	4 priza / 3m kabell	<b>990</b>

**Zgjatues kabelli me mbrojtje femijesh 3x1.5mm**



Kodi	Te dhena	Çmimi
230300031	3 priza / 3m kabell	<b>890</b>
230400031	4 priza / 3m kabell	<b>990</b>

**Zgjatues kabelli me celes e Zeze me mbrojtje femijesh 3x1.5mm**



Kodi	Te dhena	Çmimi
230301031	3 priza / 3m kabull	<b>990</b>
230301051	3 priza / 5m kabull	<b>1.290</b>
230401031	4 priza / 3m kabull	<b>1.100</b>
230601031	6 priza / 3m kabull	<b>1.250</b>
230601051	6 priza / 5m kabull	<b>1.490</b>

**Zgjatues kabulli portokalli me spine dhe prize me kapak izolimi nga lageshtia**



Kodi	Te dhena	Çmimi
5970010	10m 3x1.0mm IP44	<b>1.490</b>
5970020	20m 3x1.0mm IP44	<b>2.300</b>
5970030	30m 3x1.0mm IP44	<b>3.500</b>
5970035	35m 3x1.5mm IP44	<b>3.600</b>

**Adaptor i tokezuar**



Kodi	Te dhena	Çmimi
7712000	Me 2 vende	<b>390</b>
7713400	Me 3 vende	<b>490</b>

**7713000**



Çmimi  
**390**

**Adaptor i tokëzuar**

Me 3 vënde trekëndësh



714100



Çmimi  
**120**

**Adaptor prize**

Sistem Anglez

7714200



Çmimi  
**180**

**Adaptor shuko**

Sistem Anglez/Amerikan I bardhe

7714300



Çmimi  
**150**

**Prize shuko femer**

Me 5 vende e bardhe

**Prize shuko femer**



Kodi	Te dhena	Çmimi
7911700	e drejte e zeze	130
5511700	e gomuar e zeze	220

7911000



Çmimi  
**110**

**Spine e thjeshte shuko**

Mashkull e zeze

7711600



Çmimi  
**110**

**Spinë e 90° shuko**

Mashkull e kuqe

7711500



Çmimi  
**100**

**Spinë e drejtë shuko**

Mashkull e kuqe

7913500



Çmimi  
**150**

**Spinë e drejtë shuko**

Mashkull e zeze

5511500



Çmimi  
**190**

**Spinë shuko**

Mashkull e gomuar e zeze

5611500



Çmimi  
**290**

**Spine trefazore IP44**

E gomuar e drejte 3p+E 25A 380/450V

5611700



Çmimi  
**390**

**Prize trefazore IP44**

E gomuar e drejte 3p+E 25A 380/450V

5610000



Çmimi  
**450**

**Prize trefazore murale IP44**

Me 1 vend e gomuar 3p+E 25A

<p>5620000</p> <p><b>ERE</b></p>  <p>Çmimi <b>990</b></p>	<p>5630000</p> <p><b>ERE</b></p>  <p>Çmimi <b>1.590</b></p>	<p>5610100</p> <p><b>ERE</b></p>  <p>Çmimi <b>990</b></p>															
<p><b>Prize trefazore murale IP44</b></p> <p>Me 2 vende e gomuar 3p+E 25A 380/450V</p>	<p><b>Prize trefazore murale IP44</b></p> <p>Me 3 vende e gomuar 3p+E 25A 380/450V</p>	<p><b>Prize trefazore Binare IP44</b></p> <p>Me 2 vende e gomuar (1/16A - 1/25A) 1/3p+E 25A 380/450V // 1/ 2p+E 16A 250V</p>															
<p>5610200</p> <p><b>ERE</b></p>  <p>Çmimi <b>1.490</b></p>	<p>5620100</p> <p><b>ERE</b></p>  <p>Çmimi <b>1.450</b></p>	<p>5711500</p> <p><b>ERE</b></p>  <p>Çmimi <b>590</b></p>															
<p><b>Prize trefazore Binare IP44</b></p> <p>Me 2 vende e gomuar (1/16A - 1/25A) 1/3p+E 25A 380/450V // 1/ 2p+E 16A 250V</p>	<p><b>Prize trefazore Binare IP44</b></p> <p>(2/16A - 1/25A) 1/ 3p+E 25A 380/450V // 2/ 2p+E 16A 250V</p>	<p><b>Spine industriale trefazore</b></p> <p>16A 3p+N+E TS40 5X16A 50/60Hz 6h/380/415V</p>															
<p>5711700</p> <p><b>ERE</b></p>  <p>Çmimi <b>790</b></p>	<p>5710000</p> <p><b>ERE</b></p>  <p>Çmimi <b>950</b></p>	<p>5811500</p> <p><b>ERE</b></p>  <p>Çmimi <b>850</b></p>															
<p><b>Prize industriale trefazore IP44</b></p> <p>16A 3p+N+E TS40 5X16A 50/60Hz 6h/380/415V</p>	<p><b>Prize industriale trefazore</b></p> <p>Ajrore, 16a 3p+N+E TS40 5X16A 50/60Hz 6h/380/415V</p>	<p><b>Spine industriale trefazore IP44</b></p> <p>32A 3p+N+E TS40 5X32A 50/60Hz 6h/380/415V</p>															
<p>5811700</p> <p><b>ERE</b></p>  <p>Çmimi <b>890</b></p>	<p>5810000</p> <p><b>ERE</b></p>  <p>Çmimi <b>1.390</b></p>	<p><b>Aspirator tualeti</b></p> <p><b>BORMANN</b></p>  <p><b>IRI</b></p>															
<p><b>Prize industriale trefazore IP44</b></p> <p>32A 3p+N+E TS40 5X32A 50/60Hz 6h/380/415V</p>	<p><b>Prize industriale trefazore IP44</b></p> <p>Ajrore, 32A 3p+N+E TS40 5X32A 50/60Hz 6h/380/415V</p>	<table border="1"> <thead> <tr> <th>Kodi</th> <th>Te dhena</th> <th>Çmimi</th> </tr> </thead> <tbody> <tr> <td>BTW4300</td> <td>Ø125</td> <td><b>1.590</b></td> </tr> <tr> <td>2510200</td> <td>Ø100</td> <td><b>1.290</b></td> </tr> <tr> <td>2512200</td> <td>Ø120</td> <td><b>1.290</b></td> </tr> <tr> <td>2515200</td> <td>Ø150</td> <td><b>1.450</b></td> </tr> </tbody> </table>	Kodi	Te dhena	Çmimi	BTW4300	Ø125	<b>1.590</b>	2510200	Ø100	<b>1.290</b>	2512200	Ø120	<b>1.290</b>	2515200	Ø150	<b>1.450</b>
Kodi	Te dhena	Çmimi															
BTW4300	Ø125	<b>1.590</b>															
2510200	Ø100	<b>1.290</b>															
2512200	Ø120	<b>1.290</b>															
2515200	Ø150	<b>1.450</b>															

**Kasete plastike transparente IP65**



**E RE**

Kodi	Te dhena	Çmimi
AYKT 203013	20x30x13	<b>1.950</b>
AYKT 253515	25x35x15	<b>2.750</b>
AYKT 304017	30x40x17	<b>3.590</b>
AYKT 355019	35x50x19	<b>4.990</b>
AYKT 304022	30x40x22	<b>3.990</b>

**Tub spiral i zi**



**I RI**

Kodi	Te dhena	Çmimi
49100011	11mmx50m	<b>3.950</b>
49100014	14mmx50m	<b>4.250</b>
49100016	16mmx50m	<b>4.450</b>
49100018	18mmx50m	<b>4.750</b>

**Kanaline per panel me ngjitje**



**E RE**

Kodi	Te dhena	Çmimi
46 025 251	25x25	<b>190</b>
46 025 401	25x40	<b>290</b>
46 025 601	25x60	<b>350</b>
46 040 401	40x40	<b>330</b>
46 040 601	40x60	<b>390</b>

**Kanaline dyshemeje me ngjitje gri**



**E RE**

Kodi	Te dhena	Çmimi
45050131	50x13	<b>240</b>
45060151	60x15	<b>290</b>
45075181	75x18	<b>390</b>
45090201	90x20	<b>490</b>

**Kasete plastike transparente IP65**



**E RE**

Kodi	Te dhena	Çmimi
AYKT 405018	40x50x18	<b>5.590</b>
AYKT 405024	40x50x24	<b>5.900</b>
AYKT 406020	40x60x20	<b>6.500</b>
AYKT 506023	50x60x23	<b>7.900</b>
AYKT 507025	50x70x25	<b>8.900</b>

**Tub spiral i zi**



**I RI**

Kodi	Te dhena	Çmimi
49100021	21mmx50m	<b>4.950</b>
49100026	26mmx50m	<b>6.450</b>
49100029	29mmx50m	<b>8.750</b>
49100032	32mmx50m	<b>9.750</b>

**Kanaline per panel me ngjitje**



**E RE**

Kodi	Te dhena	Çmimi
46040801	40x80	<b>590</b>
46060401	60x40	<b>490</b>
46060601	60x60	<b>550</b>
46060801	60x80	<b>590</b>
460601001	60x100	<b>690</b>

**Kanaline me ngjitje (2m)**



**E RE**

Kodi	Te dhena	Çmimi
44012121	12x12	<b>90</b>
44015101	15x10	<b>100</b>
44016161	16x16	<b>120</b>
44020101	20x10	<b>150</b>
44025161	25x16	<b>200</b>

**49100009**



**I RI**

Çmimi  
**3.750**

**Tub spiral guajne i zi**

9mm x 50m

**Tub spiral i zi**



**I RI**

Kodi	Te dhena	Çmimi
49100037	37mmx50m	<b>12.500</b>
49100042	42mmx50m	<b>14.500</b>
49100050	20mmx50m	<b>22.500</b>
49100063	36mmx50m	<b>29.500</b>

**Kanaline dyshemeje me ngjitje e bardhe**



**E RE**

Kodi	Te dhena	Çmimi
45090201B	50x13	<b>240</b>
45050131B	60x15	<b>290</b>
45060151B	75x18	<b>390</b>
45075181B	90x20	<b>490</b>

**Kanaline me ngjitje (2m)**



**I RI**

Kodi	Te dhena	Çmimi
42502511	25x25	<b>240</b>
44040161	40x16	<b>290</b>
44040251	40x25	<b>350</b>
44040401	40x40	<b>390</b>
44060401	60x40	<b>490</b>



### Tub spiral me 2 shtresa portokalli

Kodi	Te dhena	Paketimi	Cmimi
PLN-PLSH-16	16mm Portokalli	Top 100m	39
PLN-PLSH-20	20mm Portokalli	Top 100m	45
PLN-PLSH-25	25mm Portokalli	Top 100m	59
PLN-PLSH-32	32mm Portokalli	Top 50m	79



### Sonde elektrike metalike

Kodi	Te dhena	Paketimi	Cmimi
PLN-ÇS-5	5mm	40 cope	550
PLN-ÇS-10	10mm	25 cope	690
PLN-ÇS-15	15mm	20 cope	1.250
PLN-ÇS-20	20mm	15 cope	1.590
PLN-ÇS-25	25mm	13 cope	1.790
PLN-ÇS-30	30mm	10 cope	1.990



### Sonde elektrike metalike e izoluar

Kodi	Te dhena	Paketimi	Cmimi
PLN-ÇST-5	5mm	40 cope	750
PLN-ÇST-10	10mm	25 cope	990
PLN-ÇST-15	15mm	20 cope	1.590
PLN-ÇST-20	20mm	15 cope	1.890
PLN-ÇST-25	25mm	13 cope	2.250
PLN-ÇST-30	30mm	10 cope	2.750



### Pusete plastike gri me kapak me gomine

Kodi	Te dhena	Daljet	Cmimi
PLN-MNH-20C	20x20x20cm	4 dalje	590
PLN-MNH-30C	30x30x30cm	4 dalje	990
PLN-MNH-40C	40x40x40cm	4 dalje	1.990
PLN-MNH-50C	50x50x50cm	4 dalje	4.900



### Gozhde kapese kabulli

Kodi	Te dhena	Paketimi	Cmimi
PLN-Ç-0	5mm	40 cope	1.5
PLN-Ç-2	6mm	25 cope	1.9
PLN-Ç-3	8mm	20 cope	2.0
PLN-Ç-4	10mm	15 cope	2.2
PLN-Ç-6	12mm	13 cope	2.4
PLN-Ç-7	16mm	10 cope	49
PLN-Ç-8	20mm	10 cope	7.9



## Fiksuese kabulli e bardhe me gozhde

Kodi	Te dhena	Paketimi	Cmimi
BCR5100	3/15	100 Cope	95
BCR5102	3.5/15	100 Cope	99
BCR5104	4/15	100 Cope	99
BCR5106	5/15	100 Cope	110
BCR5108	6/20	100 Cope	129
BCR5110	7/20	100 Cope	139
BCR5112	8/20	100 Cope	159
BCR5114	10/25	100 Cope	199
BCR5116	12/25	100 Cope	290
BCR5118	14/30	50 Cope	250
BCR5120	16/35	50 Cope	290
BCR5122	18/40	50 Cope	350
BCR5124	520/40	50 Cope	390
BCR5126	22/45	50 Cope	450



## Sonde elektrike najloni

### BHT7812

- Per kabull elektrik
- Gjatesia: 10 m
- 3x1.3 mm



Çmimi  
**590**

## Sonde elektrike metalike

### BHT7813

- Per kabull elektrik
- Gjatesia: 10 m
- 3x1.3 mm



Çmimi  
**550**

## Adaptor me 3 priza

### 72401

- Fuqia: 2.5A / 230V



Çmimi  
**190**

## Sensor levizje

### 83124

- Rreze: 360 grade



Çmimi  
**590**

## Tester per priza

### HESST30002

- 30 MA VDE
- Tensioni max: 250V



Çmimi  
**990**

## Llampe nate me sensor drite

### 82830

- Fuqia: 3 W
- 120 lm



Çmimi  
**590**

### Bolier uji elektrik

#### KEWH003W

- Fuqja: 7000 W
- Koha e ngrohjes: 3-5 S
- Rritja e temp. 15°C, prurja e ujit rreth 6.5 L/min
- Rritja e temp. 20°C, prurja e ujit rreth 5 L/min
- E lehtë për tu instaluar
- Set aksesorë instalimi, 1 copë valvul rregulluese



**Çmimi**  
**9.900**

### Bolier uji elektrik

#### KEWH001W

- Fuqja: 3400 W
- Koha e ngrohjes: 3-5 S
- Prurja e ujit: 3.5 L/min
- E lehtë për tu instaluar
- Me valvul sigurie dhe rregullator



**Çmimi**  
**3.900**



### Bolier uji elektrik

#### KEWH002W

- Fuqja: 5500 W
- Koha e ngrohjes: 3-5 S
- Rritja e temp. 15°C, prurja e ujit 5 L/min
- Rritja e temp. 20°C, prurja e ujit 4 L/min
- E lehtë për tu instaluar
- Me valvul sigurie dhe rregullator



**Çmimi**  
**4.900**



### Bolier dushi vertikal

#### KEWH008W

- Fuqja: 1500 W
- Tensioni: 220-240 V
- Kapaciteti: 50 L
- Presioni: 0.75 ± 0.05 MPa
- Trup metalik i papërshkrueshëm nga uji
- Instalim vertikal
- Valvul sigurie shumëfunksionale



**Çmimi**  
**14.900**



### Bolier dushi vertikal

#### KEWH009W

- Fuqja: 1500 W
- Tensioni: 220-240 V
- Kapaciteti: 80 L
- Presioni: 0.75 ± 0.05 MPa
- Trup metalik i papërshkrueshëm nga uji
- Instalim vertikal
- Valvul sigurie shumëfunksionale



**Çmimi**  
**18.500**



### Bolier dushi vertikal

#### KEWH010W

- Fuqja: 1500 W
- Tensioni: 220-240 V
- Kapaciteti: 100 L
- Presioni: 0.75 ± 0.05 MPa
- Trup metalik i papërshkrueshëm nga uji
- Instalim vertikal
- Valvul sigurie shumëfunksionale



**Çmimi**  
**19.900**



### Ngrohës uji për kuzhinë

#### KEWH011W

- Fuqja: 1500 W
- Kapaciteti: 15 L
- Temperaturë e ujit deri në 75°C
- Presioni: 0.75 ± 0.05 MPa
- E lehtë për tu instaluar
- Valvul sigurie multi-funksionale



**Çmimi**  
**11.900**



### Ngrohës uji për kuzhinë

#### KEWH012W

- Fuqja: 1500 W
- Kapaciteti: 30 L
- Temperaturë e ujit deri në 75°C
- Presioni: 0.75 ± 0.05 MPa
- E lehtë për tu instaluar
- Valvul sigurie multi-funksionale



**Çmimi**  
**15.900**







**FALA**

**75921**  
**Mishelator kuzhine**

- Fuqia 3000 W
- Temperatura 60°C
- Koha e ngrohjes 5 sec

**Çmimi**  
**3.500**



**BORMANN**  
**PRO**

**BTW3500**  
**Bolier kuzhine / banjo**

- Me ekran dixhital LED
- Fuqia 6 kW
- I bardhe

**Çmimi**  
**9.900**



**BORMANN**  
**PRO**

**BTW3550**  
**Bolier kuzhine / banjo**

- Me ekran dixhital LED
- Fuqia 7 kW
- Me set dushi

**Çmimi**  
**11.900**



- 1
- 2
- 3
- 4
- 5
- 6
- 7
- 8
- 9
- 10



**BTW3350**  
**Set dushi Evelyn**

- Me dy koka dushi rrumbullake
- Struktura mbajtëse
- Perfshin zorre dushi
- I argjendte

**Çmimi**  
**4.990**



**BTW9024**  
**Set dushi 70 cm**

- Me koke rrethore
- Dimensioni i kokës: Ø 11 mm
- Me 5 funksione
- Zorre dushi 1.5 m

**Çmimi**  
**2.690**



**BTW3355**  
**Set dushi Sunny**

- Me dy koka dushi rrumbullake dhe katrore
- Struktura mbajtëse
- Perfshin zorre dushi
- I argjendte

**Çmimi**  
**12.500**



**BTW5050**  
**Panel dushi Layla inoxi**

- Me 3 funksione
- Gjatesia: 1.5 m
- Me efekt shiu

**Çmimi**  
**16.900**



**BTW5040**  
**Set dushi Eva**

- Me dy koka dushi rrethore
- Shkop dhe zorre dushi
- Gjatesia: 1.5 m
- Dimensioni i kokës: Ø20cm

**Çmimi**  
**11.500**



**BTW5060**  
**Panel dushi Layla inoxi**

- Me 3 funksione
- Gjatesia: 1.5 m
- I zi me efekt shiu

**Çmimi**  
**19.900**



**BTW3370**  
Rubinet dushi Spring

- Me set dushi
- Dimensioni i kokes: Ø 35 mm

**Çmimi**  
**3.990**



**BTW3365**  
Rubinet dushi Spring

- Me set dushi
- Dimensioni i kokes: Ø 35 mm

**Çmimi**  
**4.500**



**BTW3250**  
Rubinet dushi Sonia

- Me set dushi
- Dimensioni i kokes: Ø 40 mm

**Çmimi**  
**4.990**



**BTW3390**  
Rubinet dushi Fiona

- Me set dushi
- Dimensioni i kokes: Ø 35 mm

**Çmimi**  
**5.990**



**BTW3010**  
Rubinet dushi Avra

- Me set dushi
- Dimensioni i kokes: Ø 35 mm

**Çmimi**  
**5.990**



**BTW3070**  
Rubinet Lavamani Sierra

- 35mm
- Me tap lavamani
- Dimensioni: 21x17x13 cm

**Çmimi**  
**5.990**



**BTW3410**  
Rubinet dushi Eva

- Me set dushi
- Dimensioni i kokes: Ø 35 mm

**Çmimi**  
**5.990**



**BTW3380**  
Rubinet dushi Violet

- Me set dushi
- Dimensioni i kokes: Ø 35 mm

**Çmimi**  
**6.500**



**BTW3320**  
Rubinet lavapjate Amelia

- Dimensioni i kokes: Ø 35 mm

**Çmimi**  
**7.500**





**BTW3030**  
**Rubinet Lavamani Iris**

- 40mm
- Me tap lavamani
- Peshha: 580g

**Çmimi**  
**3.990**



**BTW3240**  
**Rubinet lavamani Sonia**

- Dimensioni i kokes: Ø 40 mm

**Çmimi**  
**4.250**



**BTW3360**  
**Rubinet lavamani Spring**

- Dimensioni i kokes: Ø 35 mm
- I argjende

**Çmimi**  
**4.200**



**BTW3000**  
**Rubinet lavamani Avra**

- Dimensioni i kokes: Ø 35 mm

**Çmimi**  
**4.690**



**BTW3050**  
**Rubinet lavamani Sierra**

- Dimensioni i kokes: Ø 40 mm

**Çmimi**  
**4.590**



**BTW3375**  
**Rubinet lavamani Violet**

- I gjate
- Dimensioni i kokes: Ø 35 mm

**Çmimi**  
**4.990**



**BTW3405**  
**Rubinet lavamani i gjate Eva**

- Dimensioni i kokes: Ø 35 mm

**Çmimi**  
**5.500**



**BTW3385**  
**Rubinet lavamani Fiona**

- Dimensioni i kokes: Ø 35 mm

**Çmimi**  
**6.900**



**BTW3060**  
**Rubinet lavamani Sierra**

- I gjate
- Dimensioni i kokes: Ø 35 mm

**Çmimi**  
**7.990**



**BTW3140**  
**Rubinet lavapjate Julia**

• Dimensioni i kokes: Ø 35 mm

**Çmimi**  
**4.250**



**BTW3340**  
**Rubinet lavapjate Nadia**

• Me tub elastik  
• Dimensioni i kokes: Ø 40 mm

**Çmimi**  
**6.500**



**BTW3400**  
**Rubinet lavapjate Serena**

• Me koke te levizshme  
• Dimensioni i kokes: Ø 40 mm

**Çmimi**  
**7.500**



**BTW3100**  
**Rubinet Lavapjate + dushi**

• Ydra  
• 40mm  
• Peshë: 1400g

**Çmimi**  
**4.500**



**BTW3260**  
**Rubinet Lavamani Lida**

• Lida  
• 40mm

**Çmimi**  
**5.200**



**BTW3080**  
**Rubinet lavamani Silver**

• Dimensioni i kokes: Ø 35 mm

**Çmimi**  
**3.300**



**BTW3120**  
**Rubinet lavamani Star**

• Dimensioni i kokes: Ø 35 mm

**Çmimi**  
**2.690**



**BTW3150**  
**Rubinet lavapjate**

• Me montim mural  
• Dimensioni i kokes: Ø 35 mm

**Çmimi**  
**3.790**



**BTW3130**  
**Rubinet lavamani Zebra**

• Dimensioni i kokes: Ø 35 mm

**Çmimi**  
**2.990**



**BTW4610**  
Koke dushi gri e erret

- Dimensioni i kokes: Ø 41 mm\*248 mm
- Katrore

Çmimi  
**650**



**BTW4620**  
Koke dushi gri e erret

- Dimensioni i kokes: Ø 85 mm
- Rrethore

Çmimi  
**690**



**BTW4630**  
Koke dushi gri e erret

- Dimensioni i kokes: Ø 93 mm
- Rrethore
- Me 5 opsione

Çmimi  
**990**



**BTW4650**  
Koke dushi i argjende

- Dimensioni i kokes: Ø 81 mm
- Rrethore

Çmimi  
**850**



**BTW4660**  
Koke dushi i argjende

- Dimensioni i kokes: Ø 110 mm
- Me 5 opsione

Çmimi  
**990**



**BTW4640**  
Koke dushi i argjende

- Dimensioni i kokes: Ø 81 mm
- Me 5 opsione

Çmimi  
**990**



**BTW3200**  
Koke dushi e rregullueshme

Çmimi  
**1.590**



**BTW3160**  
Koke dushi me tub 1.5 m

- Gri e lehte

Çmimi  
**890**



**BTW3170**  
Koke dushi me tub 1.5 m

- Gri e forte

Çmimi  
**890**





**BTW4600**  
Koke dushi katrore

• Dimensioni i kokes: Ø 58\*234 mm

Çmimi  
**590**



**BTW9026**  
Koke dushi salishenti

• I argjende  
• Dimensioni i kokes: Ø 19.8x6.5 cm

Çmimi  
**1.990**



**BTW9028**  
Koke dushi salishenti

• I argjende  
• Dimensioni i kokes: Ø 20x20x6.6 mm  
• Katrore

Çmimi  
**1.890**



**BTW9066**  
Furce tualeti e bardhe

• Me bisht dhe kapak gold  
• Permase: Ø 9.5x38 cm

Çmimi  
**950**



**BTW9032**  
Furce tualeti e bardhe

• Me bisht druri  
• Permase: Ø 9.7x37 cm

Çmimi  
**950**



**BTW9068**  
Furce tualeti e zeze

• Me bisht dhe kapak gold  
• Permase: Ø 9.5x38 cm

Çmimi  
**950**



**BTW9034**  
Furce tualeti e zeze

• Me bisht druri  
• Permase: Ø 9.7x37 cm

Çmimi  
**950**



**BTW9014**  
Furce tualeti e argjende

• Permase Ø 9.7x38.4 cm

Çmimi  
**650**



**BTW9078**  
Furce tualeti inoxi

• Permase: Ø 8.9x36 cm

Çmimi  
**1.250**



**BTW1085**  
**Kapak tualeti i Aqua Soft**

- Me mbeshetese inoxi
- Pesha 2020 gr
- Permasa 430x360 mm

**Çmimi**  
**2.990**



**BTW1070**  
**Kapak tualeti Aries Soft**

- Me mbeshetese inoxi
- Pesha 2280 gr
- Permasa 445x360 mm

**Çmimi**  
**2.990**



**BTW1010**  
**Kapak tualeti Gemini Soft**

- Me mbeshetese inoxi
- Pesha 2551 gr
- Permasa 465x360 mm

**Çmimi**  
**2.990**



**BTW1000**  
**Kapak tualeti Hydra Soft**

- Me mbeshetese inoxi
- Pesha 2590 gr
- Permasa 450x355 mm

**Çmimi**  
**2.990**



**BTW1080**  
**Kapak tualeti Leo Soft**

- Me mbeshetese inoxi
- Pesha 2100 gr
- Permasa 445x340 mm

**Çmimi**  
**2.990**



**BTW1040**  
**Kapak tualeti Libra Soft**

- Me mbeshetese inoxi
- Pesha 2268 gr
- Permasa 435x350 mm

**Çmimi**  
**2.990**



**BTW1020**  
**Kapak tualeti Norma Soft**

- Me mbeshetese inoxi
- Pesha 2460 gr
- Permasa 425x366 mm

**Çmimi**  
**2.990**



**BTW1030**  
**Kapak tualeti Saggita Soft**

- Me mbeshetese inoxi
- Pesha 2419 gr
- Permasa 450x375 mm

**Çmimi**  
**2.990**



**BTW1075**  
**Kapak tualeti Virgo Soft**

- Me mbeshetese inoxi
- Pesha 2520 gr
- Permasa 440x345 mm

**Çmimi**  
**2.990**



**BTW9070**

**Kosh mbeturinash gri 6 Lt**

- Me mbyllje te ngadalte
- Permasa: 20.3x26x30.5 cm

**Çmimi**  
**2.200**



**BTW9062**

**Kosh mbeturinash i bardhe**

- Me kapak gold, 5 Lt
- Permasa: 20.5x26.8 cm

**Çmimi**  
**1.900**



**BTW9016**

**Kosh mbeturinash 5 Lt**

- I kromuar
- Permasa 20.5x28 cm

**Çmimi**  
**1.290**



**BTW9064**

**Kosh mbeturinash i zi 5 Lt**

- Me kapak gold
- Permasa: 20.5x26.8 cm

**Çmimi**  
**1.900**



**BTW9010**

**Mbajtese letrash higjenike**

- Inox
- Permasa: 22.5x12x26 cm

**Çmimi**  
**4.500**



**BTW9012**

**Mbajtese letrash tualeti**

- Inoxi
- Katrore
- Permasa 28x10.1x26.5 cm

**Çmimi**  
**5.200**



**BTW9018**

**Mbajtese tualeti inox**

- Me kapak
- Permasa: 13.5x5x14 cm

**Çmimi**  
**1.150**



**BTW9020**

**Mbajtese letrash tualeti**

- Inox
- Permasa: 15.2x6x10.5 cm

**Çmimi**  
**1.100**



**BTW9056**

**Mbajtese letrash tualeti i zi**

- Permasa: 15.2x6x10.5 cm

**Çmimi**  
**1.150**





**BTW4850**  
Mbajtese peshqiri

- Inoksi
- Permasa: 3 cm

Çmimi  
**2.990**



**BTW9000**  
Mbajtese peshqiri

- E dyfishte
- E kromuar
- Permasa 64.5x12x5.2 cm

Çmimi  
**2.350**



**BTW9002**  
Mbajtese peshqiri

- Rrethore
- E argjende
- Permasa 15.5 x18 cm

Çmimi  
**990**



**BTW9052**  
Mbajtese sapuni i lengshem

- Ngjyre e bardhe
- Plastik dhe dru bamboo
- Permasa 7.2x16.5 cm

Çmimi  
**690**



**BTW9051**  
Mbajtese furca dhembesh

- Ngjyre e bardhe
- Me baze bamboo
- Permasa 7.2x16.5 cm

Çmimi  
**490**



**BTW9058**  
Shishe qeramike

- Per sapun te lengshem
- Me detaje gold
- Permasa: 7.2x17 cm

Çmimi  
**790**



**BTW9060**  
Mbajtese furca dhembesh

- Ngjyre e zeze
- Me detaje gold
- Permasa 7.2x11 cm

Çmimi  
**690**



**BTW4700**  
Suport dushi inoksi

- Gjatesia: 71 cm
- Permasa: 25 mm

Çmimi  
**1.390**



**BTW4710**  
Suport dushi inoksi

- Gjatesia: 65 cm

Çmimi  
**1.990**



**BTW3220**  
Tub spiral per koke dushi

• Gjatesia: 1.5 m

Çmimi  
**490**



**BTW3210**  
Tub spiral per koke dushi

• Gjatesia: 2 m

Çmimi  
**590**



**BTW9030**  
Zorre dushi argjendi

• Gjatesia: 1.5 m

Çmimi  
**790**



**BTW9040**  
Raft tualeti

- Me 3 kate druri trekendore
- Me strukture te zeze metal
- Permasa: 20x20x63 cm

Çmimi  
**2.900**



**BTW9042**  
Raft tualeti

- Me 3 kate druri trekendore
- 1 kromuar
- Permasa: 20.8x57 cm

Çmimi  
**2.350**



**BTW3270**  
Rubinet per uje te ftohte

• 1/2"x3/4"

Çmimi  
**690**



**BTW3435**  
Rubinet per uje te ftohte

- I gjate, Nina
- Me helika 1/2"x3/4"

Çmimi  
**1.590**



**BTW3440**  
Rubinet per uje te ftohte

- I verdhe
- 1/2"x3/4"

Çmimi  
**1.290**



**BTW3430**  
Rubinet per uje te ftohte

- River
- 1/2"x3/4"

Çmimi  
**990**



Mbajtëse furcash ovale e kromuar **FALA**

69301

Mbajtëse sapuni ovale e kromuar **FALA**

69302



Çmimi  
**690**



Çmimi  
**690**

Mbajtëse letre tualeti e kromuar **FALA**

69305

Mbajtëse letre tualeti e kromuar **FALA**

69317



Çmimi  
**850**



Çmimi  
**990**



## Mbajtëse peshqiri tualeti ovale



69306



Çmimi

**990**

## Mbajtëse sapuni metalike 20 cm



69375



Çmimi

**990**

## Zhblllokuese lavamani 7cm



55500



Çmimi

**1.490**

## Zhblllokuese tubi 5m / 9mm



55544



Çmimi

**990**

## Mbajtëse peshqiri tualeti katrore



Çmimi

**1.490**

## Mbajtëse sapuni murale 500 ml



Çmimi

**950**

## Zhblllokuese tubi



**Kodi**

**Permasa**

**Cmimi**

55541

1.5m / 5mm

290

55542

3m / 6mm

390

## Zhblllokuese tubi 3m / 6mm



WDD2303



Çmimi

**350**



3.200

**75801**  
Mishelator lavamani Inox Steely  
17.5cm



3.500

**75718**  
Mishelator lavamani Inox  
17.5cm



3.690

**75716**  
Mishelator kuzhine Inoksi Steely  
37cm



4.690

**75719**  
Mishelator kuzhine Inoksi me  
koke te zgjatshme 20cm Steely  
40cm



3.900

**75802**  
Mishelator lavamani Inox Steely  
11.5cm



6.900

**75806**  
Mishelator parukerie Inoksi me  
koke dushi te zgjatshme Steely



16.900

**75665**  
Salishent dushi Inoksi katror  
Steely 87-131 cm



4.500

**75803**  
Mishelator lavamani Inox Steely  
14cm



7.500

**75805**  
Mishelator kuzhine Inoksi me  
qafe te zgjatshme Steely



11.500

**75662**  
Salishent dushi Inoksi I  
rrumbullaket Steely 96-126 cm



19.900

75813  
Salishent dushi RETRO BLACK  
klasik me 2 koka 95-130 cm



3.990

75853  
Mishelator kuzhine Steely  
BLACK 2, 35 cm



8.900

75816  
Mishelator dushi RETRO BLACK  
3 me 1 koke dushi



9.900

75884  
Mishelator kuzhine BLACK  
NOIR me koke te levizshme dhe  
zgjatje 43cm



4.500

75707  
Mishelator kuzhine me tub  
fleksibel te kuq



3.900

75706  
Mishelator kuzhine me tub fleksibel te  
bardhe



9.500

75815  
Mishelator lavamani l gjate  
RETRO BLACK 24cm



19.900

75883  
Salishent dushi BLACK NOIR  
katrore me 2 koka dushi 95-135  
cm

1

2

3

4

5

6

7

8

9

10



## PILETE DUSHI HORIZONTALE



Kodi	Permasa	Çmimi
------	---------	-------

75360	30 cm	4.200
75361	40 cm	4.690
75362	50 cm	5.200
75363	60 cm	6.500
75364	70 cm	6.900
75365	80 cm	7.500
75366	90 cm	7.900

## PILETE DUSHI HORIZONTALE ME VRIMA



Kodi	Permasa	Çmimi
------	---------	-------

75367	30 cm	4.500
75368	40 cm	4.900
75369	50 cm	5.500
75370	60 cm	5.900
75371	70 cm	6.900
75372	80 cm	7.500
75373	90 cm	7.900

## PILETE DUSHI HORIZONTALE KATRORE

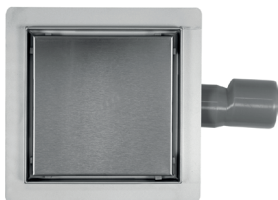

Kodi	Permasa	Çmimi
------	---------	-------

75334	150 x 150 cm	4.900
75335	200 x 200 cm	5.500
75336	250 x 250 cm	5.900



220

**75327**  
Set filter metalik mishelatori universal + 24 gomina



950

**75484**  
Pilete lavamani metalik G5/4 I kromuar



990

**75625**  
Koke dushi DETIFOS rrumbullake e kromuar me 5 funksione



790

**75632**  
Koke dushi FOBOS katrore e kromuar me 1 funksion



350

**75483**  
Pilete lavamani plastik G5/4



490

**75627**  
Koke dushi Delta rrumbullake e kromuar me 5 funksione



990

**75634**  
Koke dushi DIONE rrumbullake e kromuar me 5 funksione + buton stop



490

**75536**  
Mbajtese koke dushi e kromuar dhe kapje anesore

### TUB FLEKSIBEL F/F 1/2" 1/2"



Kodi	Permasa	Çmimi
71800	1/2" 1/2" 300 mm	250
71801	1/2" 1/2" 400 mm	290
71802	1/2" 1/2" 500 mm	320
71803	1/2" 1/2" 600 mm	350
71804	1/2" 1/2" 800 mm	380
71805	1/2" 1/2" 1000mm	390

### TUB FLEKSIBEL F/M 1/2" 1/2"



Kodi	Permasa	Çmimi
71820	1/2" 1/2" 300 mm	290
71821	1/2" 1/2" 400 mm	320
71822	1/2" 1/2" 500 mm	350
71823	1/2" 1/2" 600 mm	360
71824	1/2" 1/2" 800 mm	380
71825	1/2" 1/2" 1000mm	450



190

75564  
Mbajtëse koke dushi plastike e kromuar me kapje anësore



Zorre dushi inox I kromuar 1.5m

Kodi	Permasa	Çmimi
75645	1.5 m	290
75647	2.0 m	350

### TUB FLEKSIBEL F/F 3/8" 3/8"



Kodi	Permasa	Çmimi
71814	3/8" 3/8" 300 mm	230
71815	3/8" 3/8" 400 mm	250
71816	3/8" 3/8" 500 mm	280
71817	3/8" 3/8" 600 mm	290
71818	3/8" 3/8" 800 mm	350
71819	3/8" 3/8" 1000mm	390

### TUB FLEKSIBEL F/M 3/8" 3/8"



Kodi	Permasa	Çmimi
71833	3/8" 3/8" 300 mm	250
71834	3/8" 3/8" 400 mm	280
71835	3/8" 3/8" 500 mm	290
71836	3/8" 3/8" 600 mm	310
71837	3/8" 3/8" 800 mm	330
71838	3/8" 3/8" 1000mm	350



Zorre dushi inoxi I bardhe 1.5m

Kodi	Permasa	Çmimi
75652	1.5 m	450
75653	2.0 m	490



Zorre dushi argjend I lemuar 1.5m

Kodi	Permasa	Çmimi
75654	1.5 m	790
75655	2.0 m	950

**RUBINET LAVAMANI**
**BRONZI**

URBAN



Pilete, aksesoret e montimit dhe tubat fleksibel 3/8"x350 mm te perfshira ne paketim

Kodi	Paketimi	Çmimi
658781	24 cope	<b>1.900</b>

**RUBINET BIDE**
**BRONZI**

URBAN



Pilete, aksesoret e montimit dhe tubat fleksibel 3/8"x350 mm te perfshira ne paketim

Kodi	Paketimi	Çmimi
658780	24 cope	<b>2.000</b>

**RUBINET DUSHI**
**BRONZI**

URBAN



Rozetat Ø 35 mm, zgjatuesit 1/2", tub 1.5 m, mbajtese dhe koke dushi te perfshira ne paketim

Kodi	Paketimi	Çmimi
658779	12 cope	<b>2.200</b>

**RUBINET LAVAMANI**
**BRONZI**

ELEGANCE



Pilete, aksesoret e montimit dhe tubat fleksibel 3/8"x350 mm te perfshira ne paketim

Kodi	Paketimi	Çmimi
658784	12 cope	<b>2.800</b>

**RUBINET BIDE**
**BRONZI**

ELEGANCE



Pilete, aksesoret e montimit dhe tubat fleksibel 3/8"x420 mm te perfshira ne paketim

Kodi	Paketimi	Çmimi
658783	12 cope	<b>2.900</b>

**RUBINET DUSHI**
**BRONZI**

ELEGANCE



Rozetat Ø 35 mm dhe zgjatuesit 1/2" te perfshira ne paketim

Kodi	Paketimi	Çmimi
658782	12 cope	<b>3.300</b>

**RUBINET LAVAMANI**
**BRONZI**

artic



Pilete, aksesoret e montimit dhe tubat fleksibel 3/8"x350 mm te perfshira ne paketim

Kodi	Paketimi	Çmimi
658787	12 cope	<b>4.500</b>

**RUBINET BIDE**
**BRONZI**

artic



Pilete, aksesoret e montimit dhe tubat fleksibel 3/8"x420 mm te perfshira ne paketim

Kodi	Paketimi	Çmimi
658786	12 cope	<b>4.900</b>

**RUBINET DUSHI**
**BRONZI**

artic



Rozetat Ø 35 mm dhe zgjatuesit 1/2" te perfshira ne paketim

Kodi	Paketimi	Çmimi
658785	12 cope	<b>5.000</b>



1  
 2  
 3  
 4  
 5  
 6  
 7  
 8  
 9  
 10

**RUBINET LAVAMANI**
**BRONZI**

artic long



Pilete, aksesoret e montimit dhe tubat fleksibel 3/8"x350 mm te perfshira ne paketim

Kodi	Paketimi	Çmimi
658788	12 cope	<b>3.900</b>

**RUBINET LAVAMANI**
**BRONZI**

ELEGANCE LONG



Pilete, aksesoret e montimit dhe tubat fleksibel 3/8"x350 mm te perfshira ne paketim

Kodi	Paketimi	Çmimi
658789	12 cope	<b>2.900</b>

**RUBINET LAVAPJATE**
**BRONZI**

artic KITCHEN



Aksesoret e montimit dhe tubat fleksibel 3/8"x350 mm te perfshira ne paketim

Kodi	Paketimi	Çmimi
658790	12 cope	<b>3.900</b>

**RUBINET LAVAPJATE**
**BRONZI**

URBAN KITCHEN



Aksesoret e montimit dhe tubat fleksibel 3/8"x350 mm te perfshira ne paketim

Kodi	Paketimi	Çmimi
658791	12 cope	<b>2.900</b>

**RUBINET LAVAPJATE**
**BRONZI**

artic KITCHEN

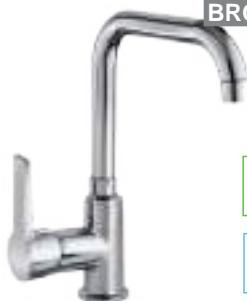

Aksesoret e montimit dhe tubat fleksibel 3/8"x350 mm te perfshira ne paketim

Kodi	Paketimi	Çmimi
658792	12 cope	<b>2.900</b>

**RUBINET LAVAPJATE**
**BRONZI**

artic KITCHEN



Aksesoret e montimit dhe tubat fleksibel 3/8"x350 mm te perfshira ne paketim

Kodi	Paketimi	Çmimi
658793	12 cope	<b>1.500</b>

**SET SHATTAF**
**BRONZI**

URBAN



Koka me sigures, tub 1.5 m, dhe mbajttese te perfshira ne paketim

Kodi	Paketimi	Çmimi
658794	12 cope	<b>890</b>

**SET SHATTAF**
**BRONZI**

artic



Koka me sigures, tub 1.5 m, dhe saracineska me mbajttese te perfshira ne paketim

Kodi	Paketimi	Çmimi
658795	12 cope	<b>1.990</b>

**SET SHATTAF INOKS**
**BRONZI**

artic



Koka me sigures, tub 1.5 m, dhe saracineska me mbajttese te perfshira ne paketim

Kodi	Paketimi	Çmimi
658796	12 cope	<b>1.590</b>

**KOKE DUSHI ABS**

Kodi	Permasa	Çmimi
658750	55x110mm	<b>150</b>

**KOKE DUSHI ABS**

Kodi	Permasa	Çmimi
658751	30x205mm	<b>290</b>

**KOKE DUSHI ABS**

Kodi	Permasa	Çmimi
658752	Ø 100 mm	<b>200</b>

**KOKE DUSHI ABS**

Kodi	Permasa	Çmimi
658753	Ø 100 mm	<b>250</b>

**SET KOKE DUSHI ABS**

Kodi	Permasa	Çmimi
658754	Ø 100 mm	<b>490</b>

**SALISHENT**

artic SHOWER



Kodi	Permasa	Çmimi
658757	144x40 cm	<b>5.900</b>

**TUB DUSHI**

Kodi	Permasa	Çmimi
658755	1.5 M	<b>150</b>

**TUB DUSHI INOX**

Kodi	Permasa	Çmimi
658756	1.5 M	<b>350</b>

**MINIFILTER 1/2"x1/2"**

Kodi	Paketimi	Çmimi
658800	12 cope	<b>390</b>

**MINIFILTER 1/2"x3/4"**

Kodi	Paketimi	Çmimi
658801	12 cope	<b>450</b>

**SARAÇINESKE 1/2"**

Kodi	Paketimi	Çmimi
658799	12 cope	<b>550</b>

**PILETE LAVAMANI**

Kodi	Materiali	Çmimi
658761	Plastik	<b>200</b>

**PILETE LAVAMANI**

Kodi	Materiali	Çmimi
658797	Zink	<b>390</b>

**SET AKSESORESH 6 PC**

Kodi	Materiali	Çmimi
658798	Alumin	<b>2.500</b>

**GALIXHANT KASETE**

Kodi	Lartesia	Çmimi
658760	28 cm	<b>750</b>

**TUB FURNIZIMI**

Kodi	Gjatesia	Çmimi
658758	1.5 m	<b>250</b>

**TUB SHKARKIMI**

Kodi	Gjatesia	Çmimi
658759	1.5 m	<b>250</b>



## RAKORDE HIDRAULIKE

3263/ 4263



### MANIKOTE PN16

Kodi	Permasa	Modeli	Paketimi	Çmimi
3263/2020	20 x 20 mm	PN16	50 cope	100
3263/2525	25 x 25 mm	PN16	50 cope	150
3263/3232	32 x 32 mm	PN16	50 cope	200
3263/4040	40 x 40 mm	PN16		300
3263/5050	50 x 50 mm	PN16		400
3263/6363	63 x 63 mm	PN16		600
4263/7575	75 x 75 mm	PN16		1.100
4263/9090	90 x 90 mm	PN16		1.700
4263/1111	110 x 110 mm	PN16		2.400
4262/1212	125 x 125 mm	PN16		3.500

3263



### MANIKOTE ME REDUKSION PN16

Kodi	Permasa	Modeli	Paketimi	Çmimi
3263/2520	25 x 20mm	PN16	50 cope	180
3263/3225	32 x 25mm	PN16	50 cope	250
3263/4032	40 x 32mm	PN16		330
3263/5040	50 x 40mm	PN16		500
3263/6340	63 x 40mm	PN16		650
3263/6350	63 x 50mm	PN16		700

3673 / 4673



### MANIKOTE TI PN16

Kodi	Permasa	Modeli	Paketimi	Çmimi
3673/2020	20 x 20 x 20 mm	PN16	50 cope	200
3673/2525	25 x 25 x 25 mm	PN16	50 cope	250
3673/3232	32 x 32 x 32 mm	PN16		300
3673/4040	40 x 40 x 40 mm	PN16		550
3673/5050	50 x 50 x 50 mm	PN16		800
4673/6363	63 x 63 x 63 mm	PN16		1.100
4673/7575	75 x 75 x 75 mm	PN16		2.000
4673/9090	90 x 90 x 90 mm	PN16		2.700
4673/1111	110 x 110 x 110 mm	PN16		3.500

## RAKORDE HIDRAULIKE

3653/4653

## MANIKOTE TI F/MASHKULL PN16

Kodi	Permasa	Modeli	Paketimi	Çmimi
3653/0201	20 x ½" x 20	PN16	50 cope	170
3653/0202	20 x ¾" x 20	PN16	50 cope	170
3653/0252	25 x ¾" x 25	PN16	50 cope	240
3653/0323	32 x 1" x 32	PN16		300
3653/0404	40 x 1¼" x 40	PN16		500
3653/0405	40 x 1½" x 40	PN16		500
3653/0505	50 x 1½" x 50	PN16		700
3653/0506	50 x 2" x 50	PN16		750
4653/0636	63 x 2" x 63	PN16		960
4653/0757	75 x 2½" x 75	PN16		1.500
4653/0908	90 x 3" x 90	PN16		2.400
4653/1109	110 x 4" x 110	PN16		3.500



3298/ 4300

## BRRYL

Kodi	Permasa	Modeli	Paketimi	Çmimi
3298/2020	20 x 20 mm	PN16	50 cope	100
3298/2525	25 x 25 mm	PN17	50 cope	200
3298/3232	32 x 32 mm	PN18		250
3298/4040	40 x 40 mm	PN19		400
3298/5050	50 x 50 mm	PN50		500
4300/6363	63 x 63 mm	PN21		750
4300/7575	75 x 75 mm	PN22		1.500
4300/9090	90 x 90 mm	PN23		2.000
4300/1111	110 x 110 mm	PN24		3.000



3294/4294

## BRYLL F/MASHKULL PN16

Kodi	Permasa	Modeli	Paketimi	Çmimi
3294/3201	20 x ½"	PN16	50 cope	80
3294/3252	25 x ¾"	PN16	50 cope	100
3294/3323	32 x 1"	PN16	50 cope	180
3294/3404	40 x 1¼"	PN16		300
3294/3405	40 x 1½"	PN16		300
3294/3505	50 x 1½"	PN16		400
4294/3636	63 x 2"	PN16		650



## RAKORDE HIDRAULIKE

3253/ 4253



### MANIKOTE F/MASHKULL PN16

Kodi	Permasa	Modeli	Çmimi
3253/0201	20 x 1/2"	PN16	80
3253/0202	20 x 3/4"	PN16	80
3253/0252	25 x 3/4"	PN16	100
3253/0253	25 x 1"	PN16	100
3253/0322	32 x 3/4"	PN16	130
3253/0323	32 x 1"	PN16	120
3253/0403	40 x 1"	PN16	200
3253/0404	40 x 1 1/4"	PN16	200
3253/0405	40 x 1 1/2"	PN16	200
3253/0406	40 x 2"	PN16	300
3253/0505	50 x 1 1/2"	PN16	300
3253/0506	50 x 2"	PN16	500
3253/0635	63 x 1 1/2"	PN16	500
3253/0636	63 x 2"	PN16	500
3253/0637	63 x 2 1/2"	PN16	900
4253/0757	75 x 2 1/2"	PN16	1.200
4253/0908	90 x 3"	PN16	1.100
4253/1109	110 x 4"	PN16	2.500
4252/1259	125 x 4"	PN16	

3205



### FASHETE ME QAFORE PN16

Kodi	Permasa	Modeli	Çmimi
3205/0631	63 x 1/2"	PN16	700
3205/0632	63 x 3/4"	PN16	750
3205/0633	63 x 1"	PN16	790
3205/0751	75 x 1/2"	PN16	850
3205/0752	75 x 3/4"	PN16	890
3205/0753	75 x 1"	PN16	950
3205/0901	90 x 1/2"	PN16	950
3205/0902	90 x 3/4"	PN16	990
3205/0903	90 x 1"	PN16	990
3205/1101	110 x 1/2"	PN16	990
3205/1102	110 x 3/4"	PN16	990
3205/1103	110 x 1"	PN16	1.100



## FASHETE ME QAFORE PN10

Kodi	Permasa	Modeli	Çmimi
4202/0251	25 x ½"	PN10	120
4202/0252	25 x ¾"	PN10	120
3202/0321	32 x ½"	PN10	120
3202/0322	32 x ¾"	PN10	170
4202/0323	32 x 1"	PN10	170
3202/0401	40 x ½"	PN10	200
3202/0402	40 x ¾"	PN10	200
3202/0403	40 x 1"	PN10	200
3202/0501	50 x ½"	PN10	220
3202/0502	50 x ¾"	PN10	220
3202/0503	50 x 1"	PN10	220
3202/0631	63 x ½"	PN10	300
3202/0632	63 x ¾"	PN10	300
3202/0633	63 x 1"	PN10	300
3202/0635	63 x 1½"	PN10	350
3202/0751	75 x ½"	PN10	350
3202/0752	75 x ¾"	PN10	350
3202/0753	75 x 1"	PN10	350
3202/0755	75 x 1½"	PN10	400
3202/0756	75 x 2"	PN10	400
3202/0901	90 x ½"	PN10	400
3202/0902	90 x ¾"	PN10	400
3202/0903	90 x 1"	PN10	400
3202/0905	90 x 1½"	PN10	450
3202/0906	90 x 2"	PN10	450
3202/1101	110 x ½"	PN10	500
3202/1102	110 x ¾"	PN10	500
3202/1103	110 x 1"	PN10	500
3202/1105	110 x 1½"	PN10	500
3202/1106	110 x 2"	PN10	500
3202/1253	125 x 1"	PN10	650
3202/1255	125 x 1½"	PN10	750
3202/1256	125 x 2"	PN10	790
4202/1403	140 x 1"	PN10	900
4202/1405	140 x 1½"	PN10	900
4202/1406	140 x 2"	PN10	900
4202/1603	160 x 1"	PN10	1.200
4202/1605	160 x 1½"	PN10	1.200
4202/1606	160 x 2"	PN10	1.200
4202/2003	200 x 1"	PN10	2.400
4202/2005	200 x 1½"	PN10	2.400
4202/2006	200 x 2"	PN10	2.400



## RAKORDE HIDRAULIKE

3201



### FASHETE ME QAFORE ME RRESHKITJE PN6

Kodi	Permasa	Modeli	Çmimi
3201/0501	50 x ½"	PN6	250
3201/0502	50 x ¾"	PN6	250
3201/0632	63 x ¾"	PN6	250

4200



### UNAZE GOME PER FASHETE ME QAFORE ME RRESHKITJE

Kodi	Permasa	Çmimi
4200/0032	32	50
4200/4050	40-50	80
4200/6311	63 x 110	100

3252



### MANIKOTE F/MASHKUL PN10

Kodi	Permasa	Modeli	Paketimi	Çmimi
3252/0201	20 x ½"	PN10	50 cope	150
3252/0202	20 x ¾"	PN10	50 cope	150
3252/0252	25 x ¾"	PN10	50 cope	150
3252/0253	25 x 1"	PN10	50 cope	200
3252/0322	32 x ¾"	PN10	50 cope	200
3252/0323	32 x 1"	PN10	50 cope	200

3256



### MANIKOTE F/FEMER PN10

Kodi	Permasa	Modeli	Paketimi	Çmimi
3256/0201	20 x ½"	PN10	50 cope	200
3256/0202	20 x ¾"	PN10	50 cope	200
3256/0252	25 x ¾"	PN10	50 cope	200
3256/0253	25 x 1"	PN10	50 cope	220
3256/0322	32 x ¾"	PN10	50 cope	250
3256/0323	32 x 1"	PN10	50 cope	250

## RAKORDE HIDRAULIKE

3262

## MANIKOTE PN10

Kodi	Permasa	Modeli	Paketimi	Çmimi
3262/2020	20 x 20	PN10	50 cope	200
3262/2525	25 x 25	PN10	50 cope	250
3262/3232	32 x 32	PN10	50 cope	300



3262

## MANIKOTE ME REDUKSION PN10

Kodi	Permasa	Modeli	Paketimi	Çmimi
3262/2520	25 x 20	PN10	50 cope	300
3262/3225	32 x 25	PN10	50 cope	370



3271

## MANIKOTE TI PN10

Kodi	Permasa	Modeli	Paketimi	Çmimi
3671/2020	20 x 20	PN10	50 cope	250
3671/2525	25 x 25	PN10	50 cope	300
3671/3232	32 x 32	PN10	50 cope	380



4672

## MANIKOTE TI ME REDUKSION PN10

Kodi	Permasa	Modeli	Paketimi	Çmimi
4672/2520	20 x 20 x 20	PN10	10 cope	500
4672/3225	25 x 25 x 25	PN10	5 cope	650
4672/4032	32 x 32 x 32	PN10		750



4661/3661

## MANIKOTE TI F/FEMER PN10

Kodi	Permasa	Modeli	Paketimi	Çmimi
4661/0201	20 x 1/2" x 20	PN10	20 cope	300
4661/0202	20 x 3/4" x 20	PN10	20 cope	300
4661/0252	25 x 3/4" x 25	PN10	10 cope	400
4661/0253	25 x 1" x 25	PN10	10 cope	400
3661/0322	32 x 3/4" x 32	PN10		500
3661/0323	32 x 1" x 32	PN10		500





## RAKORDE HIDRAULIKE

3651



### MANIKOTE TI F/MASHKULL PN10

Kodi	Permasa	Modeli	Paketimi	Çmimi
3651/0201	20 x ½" x 20	PN10	50 cope	300
3651/0202	20 x ¾" x 20	PN10	50 cope	300
3651/0203	20 x 1" x 20	PN10	50 cope	350
3651/0251	25 x ½" x 25	PN10	50 cope	350
3651/0252	25 x ¾" x 25	PN10	50 cope	350
3651/0253	25 x 1" x 25	PN10	50 cope	350
3651/0321	32 x ½" x 32	PN10		400
3651/0322	32 x ¾" x 32	PN10		400
3651/0323	32 x 1" x 32	PN10		400

3282



### BRYLL F/MASHKULL PN10

Kodi	Permasa	Modeli	Paketimi	Çmimi
3282/0201	20 x ½"	PN10	50 cope	200
3282/0202	20 x ¾"	PN10	50 cope	200
3282/0251	25 x ½"	PN10	50 cope	200
3282/0252	25 x ¾"	PN10	50 cope	200
3282/0253	25 x 1"	PN10	50 cope	200
3282/0321	32 x ½"	PN10	50 cope	250
3282/0322	32 x ¾"	PN10	50 cope	250
3282/0323	32 x 1"	PN10	50 cope	250

4283/3283



### BRYLL F/FEMER PN10

Kodi	Permasa	Modeli	Paketimi	Çmimi
4283/0201	20 x ½"	PN10	50 cope	250
4283/0202	20 x ¾"	PN10	50 cope	250
4283/0252	25 x ¾"	PN10	50 cope	300
4283/0253	25 x 1"	PN10	50 cope	300
3283/0322	32 x ¾"	PN10	50 cope	300
3283/0323	32 x 1"	PN10	50 cope	300

3262



### BRYL PN10

Kodi	Permasa	Modeli	Paketimi	Çmimi
3299/2020	20 x 20	PN10	50 cope	250
3299/2525	25 x 25	PN10	50 cope	300
3299/3232	32 x 32	PN10		350

## RAKORDE HIDRAULIKE

3251

## MANIKOTE F/MASHKULL PN6

Kodi	Permasa	Modeli	Paketimi	Çmimi
3251/0201	20 x ½"	PN6	50 cope	80
3251/0202	20 x ¾"	PN6	50 cope	80
3251/0252	25 x ¾"	PN6	50 cope	120
3251/0253	25 x 1"	PN6	50 cope	120



3250

## MANIKOTE F/FEMER PN6

Kodi	Permasa	Modeli	Paketimi	Çmimi
3250/0201	20 x ½"	PN6	50 cope	200
3250/0202	20 x ¾"	PN6	50 cope	200
3250/0251	25 x ½"	PN6	50 cope	250
3250/0252	25 x ¾"	PN6	50 cope	250
3250/0253	25 x 1"	PN6	50 cope	250



3261

## MANIKOTE BASHKUESE PN6

Kodi	Permasa	Modeli	Paketimi	Çmimi
3261/2020	20 x 20	PN6	50 cope	150
3261/2525	25 x 25	PN6	50 cope	200



3261

## MANIKOTE ME REDUKSION PN6

Kodi	Permasa	Modeli	Paketimi	Çmimi
3261/2520	25 x 20	PN6	50 cope	200
3261/3220	32 x 20	PN6	50 cope	250
3261/3225	32 x 25	PN6	50 cope	250



3291

## MANIKOTE TI PN6

Kodi	Permasa	Modeli	Paketimi	Çmimi
3291/2020	20 x 20 x 20	PN6	50 cope	150
3291/2525	25 x 25 x 25	PN6	50 cope	250



## RAKORDE HIDRAULIKE

3300



### BRRYL PN6

Kodi	Permasa	Modeli	Paketimi	Çmimi
3300/2020	20 x 20	PN6	50 cope	150
3300/2525	25 x 25	PN6	50 cope	200

3300



### BRRYL ME REDUKSION PN6

Kodi	Permasa	Modeli	Paketimi	Çmimi
3300/2520	25 x 20	PN6	50 cope	200
3300/3225	32 x 25	PN6	50 cope	350

3301



### NIPEL PLASTIK

Kodi	Permasa	Paketimi	Çmimi
3301/0101	½" x ½"	100 cope	50
3301/0202	¾" x ¾"	100 cope	60
3301/0303	1" x 1"	100 cope	70
3301/0404	1 1/4" x 1 1/4"	100 cope	100
3301/0505	1 ½" x 1 ½"	10 cope	150
3301/0606	2" x 2"	10 cope	180

3302



### REDUKSION PLASTIK M/MASHKULL

Kodi	Permasa	Paketimi	Çmimi
3302/0201	¾" x ½"	100 cope	50
3302/0301	1" x ½"	100 cope	60
3302/0302	1" x ¾"	100 cope	60
3302/0402	1 1/4" x ¾"	100 cope	100
3302/0403	1 1/4" x 1"	10 cope	100
3302/0405	1 ½" x 1 1/4"	10 cope	150
3302/0506	2" x 1 ½"	10 cope	200

3352



### REDUKSION PLASTIK M/MASHKULL

Kodi	Permasa	Paketimi	Çmimi
3352/0301	1" x ½"	100 cope	70
3352/0302	1" x ¾"	100 cope	100
4352/0403	1 1/4" x 1"	10 cope	200
3352/0504	1 ½" x 1 1/4"	10 cope	300
3352/0604	2" x 1 1/4"	10 cope	350
3352/0605	2" x 1 ½"	10 cope	350



## RAKORDE HIDRAULIKE

3351

## MANIKOTE F/FEMER

Kodi	Permasa	Paketimi	Çmimi
3351/0101	½" x ½"	50 cope	80
3351/0202	¾" x ¾"	100 cope	80
3351/0303	1" x 1"	100 cope	100



3311

## MANIKOTE TI PLASTIKE M/M/MASHULL

Kodi	Permasa	Paketimi	Çmimi
3311/0111	½" x ½" x ½"	100 cope	100
3311/0222	¾" x ¾" x ¾"	100 cope	200
3311/0333	1" x 1" x 1"	100 cope	250



3611

## MANIKOTE TI PLASTIKE F/F/FEMER

Kodi	Permasa	Paketimi	Çmimi
3611/0111	½" x ½"	20 cope	100
3611/0222	¾" x ¾"	20 cope	200
3611/0333	1" x 1"	20 cope	250



3310

## BRYLL PLSTIK M/MASHKULL

Kodi	Permasa	Paketimi	Çmimi
3310/0101	½" x ½"	100 cope	60
3310/0202	¾" x ¾"	100 cope	120
3310/0303	1" x 1"	100 cope	180



3308

## BRYLL PLSTIK F/MASHKULL

Kodi	Permasa	Paketimi	Çmimi
3308/0101	½" x ½"	100 cope	100
3308/0201	¾" x ¾"	100 cope	100
3308/0202	¾" x ¾"	100 cope	120
3308/0302	1" x ¾"	100 cope	120
3308/0303	1" x 1"	100 cope	150



## RAKORDE HIDRAULIKE

3610



### BRRYL PLASTIK F/FEMER

Kodi	Permasa	Paketimi	Çmimi
3610/0101	½" x ½"	20 cope	100
3610/0202	¾" x ¾"	20 cope	150
3610/0303	1" x 1"	20 cope	180

3331



### TAPE FUNDORE M

Kodi	Permasa	Paketimi	Çmimi
3331/0001	½"	100 cope	50
3331/0002	¾"	100 cope	80
3331/0003	1"	100 cope	100

## RAKORDE HIDRAULIKE

Y270/9270



### MANIKOTE LISHO PN25

Kodi	Permasa	Modeli	Paketimi	Çmimi
Y270/0020	20 x 20	PN25	10 cope	30
Y270/0025	25 x 25	PN25	10 cope	40
9270/0032	32 x 32	PN25	200 cope	80

9242



### MANIKOTE ME REDUKSION PN25

Kodi	Permasa	Modeli	Paketimi	Çmimi
9242/2520	25 x 20	PN25	40 cope	45
9242/3220	32 x 20	PN25	40 cope	50
9242/3225	32 x 25	PN25	30 cope	55

Y130/9130



### TI LISHO PN25

Kodi	Permasa	Modeli	Paketimi	Çmimi
Y130/0020	20 x 20 x 20 90°	PN25	10 cope	45
Y130/0025	25 x 25 x 25 90°	PN25	10 cope	55
9130/0032	32 x 32 x 32 90°	PN25	15 cope	65

## RAKORDE HIDRAULIKE

Y130/9130

## TI LISHO ME REDUKTIM PN25

Kodi	Permasa	Modeli	Paketimi	Çmimi
Y130/0020	25 x 20 x 25 90°	PN25	10 cope	55
Y130/0025	32 x 20 x 32 90°	PN25	15 cope	75
9130/0032	32 x 25 x 32 90°	PN25	15 cope	85



Y090/9090

## BRRYL LISHO PN25

Kodi	Permasa	Modeli	Paketimi	Çmimi
Y090/0020	20 x 20 90°	PN25	10 cope	40
Y090/0025	25 x 25 90°	PN25	10 cope	55
9090/0032	32 x 32 90°	PN25	25 cope	75



9041

## BRRYL LISHO PN25

Kodi	Permasa	Modeli	Paketimi	Çmimi
9041/0020	20 x 20 45°	PN25	50 cope	40
9041/0025	25 x 25 45°	PN25	50 cope	55
9041/0032	32 x 32 45°	PN25	25 cope	75



Y134/9134

## TI ME FILETO MASHKULL

Kodi	Permasa	Modeli	Paketimi	Çmimi
Y134/2003	90°, 20 x 1/2" x 20	PN25	10 cope	290
9134/2504	90°, 25 x 3/4" x 25	PN25	10 cope	390
9134/3205	90°, 32 x 1" x 32	PN25	10 cope	690



Y132/9132

## TI ME FILETO FEMER

Kodi	Permasa	Modeli	Paketimi	Çmimi
Y132/2003	90°, 20 x 1/2" x 20	PN25	10 cope	250
9132/2504	90°, 25 x 3/4" x 25	PN25	10 cope	350
9132/3205	90°, 32 x 1" x 32	PN25	10 cope	650





## RAKORDE HIDRAULIKE

9599



### SARACINESKE ME SFERE ME RUBINET TE KROMUAR

Kodi	Permasa	Çmimi
9599/0020	20 mm	990

9704



### SARACINESKE ME GOMINE ME RUBINET TE KROMUAR

Kodi	Permasa	Çmimi
9704/0020	20 mm	890
9704/0032	32 mm	990

9597



### SARACINESKE ME GOMINE ME KAPUÇ

Kodi	Permasa	Çmimi
9597/0020	20 mm	990

9598



### SARACINESKE ME SFERE ME BISHT PLASTIK

Kodi	Permasa	Çmimi
9598/0020	20 x 20	290
9598/0025	25 x 25	450
9598/0032	32 x 32	690

Y243/9243



### MANIKOTE REDUKSION PN25

Kodi	Permasa	Modeli	Paketimi	Çmimi
Y243/2520	25 x 20	PN25	10 cope	50
9243/3220	32 x 20	PN25	10 cope	80
9243/3225	32 x 25	PN25	10 cope	80

Y301/9301



### TAPE ME NGJITJE FEMER PN25

Kodi	Permasa	Modeli	Paketimi	Çmimi
Y301/0020	20	PN25	10 cope	50
Y301/0025	25	PN25	10 cope	60
9301/0032	32	PN25	50 cope	70

9302/0004



### TAPE E SHKURTER ME GOMINE

Kodi	Permasa	Modeli	Paketimi	Çmimi
9302/0004	3/4"	PN25	10 cope	50

## RAKORDE HIDRAULIKE

9285

## KALESE LISHO PN20

Kodi	Permasa	Modeli	Paketimi	Çmimi
9285/0020	20	PN20	15 cope	100
9285/0025	25	PN20	10 cope	150
9285/0032	32	PN20	5 cope	290



Y093/9093

## BRRYL F/MASHKULL PN25

Kodi	Permasa	Modeli	Paketimi	Çmimi
Y093/2003	90°, 20 x 1/2"	PN25	10 cope	250
9093/2504	90°, 25 x 3/4"	PN25	10 cope	390
9093/3205	90°, 32 x 1"	PN25	10 cope	590



Y091/9091

## BRRYL F/FEMER PN25

Kodi	Permasa	Modeli	Paketimi	Çmimi
Y091/2003	90°, 20 x 1/2"	PN25	10 cope	190
9091/2504	90°, 25 x 3/4"	PN25	10 cope	290
9091/3205	90°, 32 x 1"	PN25	15 cope	590



Y271/9271

## MANIKOTE FEMER

Kodi	Permasa	Modeli	Paketimi	Çmimi
Y271/2003	90°, 20 x 1/2"	PN25	10 cope	175
9271/2504	90°, 25 x 3/4"	PN25	10 cope	290
9271/3205	90°, 32 x 1"	PN25	10 cope	590



Y244/9244

## MANIKOTE M/FEMER

Kodi	Permasa	Modeli	Paketimi	Çmimi
Y244/2003	90°, 20 x 1/2"	PN25	10 cope	290
9244/2504	90°, 25 x 3/4"	PN25	20 cope	490
9244/3205	90°, 32 x 1"	PN25	10 cope	690



9181

## BRRYL ÇIFT

Kodi	Permasa	Modeli	Çmimi
9181/2003	20 x 1/2"	PN25	490



102000



### Tub shkarkimi

Kodi	Permasa	Gjatesia	Çmimi
10200001	Ø 32	0.25 m	<b>100</b>
10200002	Ø 32	0.5 m	<b>150</b>
10200004	Ø 32	1 m	<b>190</b>
10200006	Ø 32	2 m	<b>350</b>
10200007	Ø 32	3 m	<b>550</b>

102000



### Tub shkarkimi

Kodi	Permasa	Gjatesia	Çmimi
10200021	Ø 40	0.25 m	<b>100</b>
10200022	Ø 40	0.5 m	<b>150</b>
10200024	Ø 40	1 m	<b>250</b>
10200026	Ø 40	2 m	<b>450</b>
10200027	Ø 40	3 m	<b>590</b>

102000



### Tub shkarkimi

Kodi	Permasa	Gjatesia	Çmimi
10200041	Ø 50	0.25 m	<b>100</b>
10200042	Ø 50	0.5 m	<b>190</b>
10200044	Ø 50	1 m	<b>250</b>
10200046	Ø 50	2 m	<b>450</b>
10200047	Ø 50	3 m SDR 42	<b>650</b>

102001



### Tub shkarkimi

Kodi	Permasa	Gjatesia	Çmimi
10200101	Ø 75	0.25 m	<b>190</b>
10200102	Ø 75	0.5 m	<b>290</b>
10200104	Ø 75	1 m	<b>390</b>
10200106	Ø 75	2 m	<b>750</b>
10200107	Ø 75	3 m	<b>990</b>

102001



### Tub shkarkimi

Kodi	Permasa	Gjatesia	Çmimi
10200151	Ø 90	0.25 m	<b>250</b>
10200152	Ø 90	0.5 m	<b>350</b>
10200154	Ø 90	1 m	<b>590</b>
10200156	Ø 90	2 m	<b>990</b>
10200158	Ø 90	3 m	<b>1.450</b>



102002

### Tub shkarkimi

Kodi	Permasa	Gjatesia	Çmimi
10200201	Ø 110	0.25 m	<b>250</b>
10200215	Ø 110	0.5 m	<b>390</b>
10200204	Ø 110	1 m	<b>690</b>
10200206	Ø 110	2 m	<b>1.250</b>
10200207	Ø 110	3 m	<b>1.750</b>



102002

### Tub shkarkimi

Kodi	Permasa	Gjatesia	Çmimi
10200221	Ø 125	0.25 m	<b>350</b>
10200235	Ø 125	0.5 m	<b>750</b>
10200224	Ø 125	1 m	<b>950</b>
10200226	Ø 125	2 m	<b>1.750</b>
10200227	Ø 125	3 m	<b>2.490</b>



102015

### Ypsilon me 2 dalje

Kodi	Permasa	Lloji	Çmimi
10201505	Ø 50 Ø 50 Ø 50	45° gri	<b>290</b>
10201538	Ø 50 Ø 110 Ø 50	45° gri	<b>590</b>
10201544	Ø 110 Ø 110 Ø 110	45° gri	<b>650</b>



102990

### Pilete Inoksi

Kodi	Permasa	Lloji	Çmimi
10299000	Ø 50 H	150x150 gri	<b>390</b>
10299002	Ø 75 H	150x150 gri	<b>450</b>



102990

### Pilete Inoksi

Kodi	Permasa	Lloji	Çmimi
10299001	Ø 50 V	150x150 gri	<b>390</b>
10299003	Ø 75 V	200x200 gri	<b>750</b>



102003



### Brryl me gomine

Kodi	Permasa	Lloji	Çmimi
10200300	Ø 32	15° gri	<b>50</b>
10200301	Ø 40	15° gri	<b>70</b>
10200302	Ø 50	15° gri	<b>90</b>
10200304	Ø 75	15° gri	<b>150</b>
10200329	Ø 90	15° gri	<b>170</b>
10200308	Ø 110	15° gri	<b>190</b>
10200309	Ø 125	15° gri	<b>350</b>

102005



### Brryl me gomine

Kodi	Permasa	Lloji	Çmimi
10200500	Ø 32	30° gri	<b>50</b>
10200501	Ø 40	30° gri	<b>70</b>
10200502	Ø 50	30° gri	<b>90</b>
10200504	Ø 75	30° gri	<b>150</b>
10200529	Ø 90	30° gri	<b>170</b>
10200508	Ø 110	30° gri	<b>190</b>
10200509	Ø 125	30° gri	<b>350</b>
10200510	Ø 160	30° gri	<b>590</b>

102006



### Brryl me gomine

Kodi	Permasa	Lloji	Çmimi
10200600	Ø 32	45° gri	<b>50</b>
10200601	Ø 40	45° gri	<b>70</b>
10200602	Ø 50	45° gri	<b>90</b>
10200604	Ø 75	45° gri	<b>150</b>
10200611	Ø 90	45° gri	<b>170</b>
10200608	Ø 110	45° gri	<b>190</b>
10200609	Ø 125	45° gri	<b>350</b>
10200610	Ø 160	45° gri	<b>590</b>

102008



### Brryl me gomine

Kodi	Permasa	Lloji	Çmimi
10200800	Ø 32	90° gri	<b>50</b>
10200801	Ø 40	90° gri	<b>70</b>
10200802	Ø 50	90° gri	<b>90</b>
10200804	Ø 75	90° gri	<b>150</b>
10200811	Ø 90	90° gri	<b>170</b>
10200808	Ø 110	90° gri	<b>190</b>
10200809	Ø 125	90° gri	<b>350</b>
10200810	Ø 160	90° gri	<b>590</b>

102009

## Ypsilon me gomine

Kodi	Permasa	Lloji	Çmimi
10200900	Ø 32	45° gri	<b>100</b>
10200901	Ø 32	45° gri	<b>120</b>
10200902	Ø 40	45° gri	<b>130</b>
10200903	Ø 50	45° gri	<b>140</b>
10200904	Ø 50	45° gri	<b>150</b>
10200905	Ø 50	45° gri	<b>120</b>
10200912	Ø 75	45° gri	<b>170</b>
10200914	Ø 75	45° gri	<b>250</b>
10200938	Ø 110	45° gri	<b>290</b>
10200940	Ø 110	45° gri	<b>350</b>
10200944	Ø 110	45° gri	<b>390</b>
10200953	Ø 125	45° gri	<b>590</b>
10200954	Ø 125	45° gri	<b>690</b>
10200963	Ø 160	45° gri	<b>850</b>
10200964	Ø 160	45° gri	<b>990</b>
10200965	Ø 160	45° gri	<b>1.100</b>



102011

## Tl me gomine

Kodi	Permasa	Lloji	Çmimi
10201100	Ø 32 Ø 32	90° gri	<b>90</b>
10201101	Ø 40 Ø 32	90° gri	<b>120</b>
10201102	Ø 40 Ø 40	90° gri	<b>150</b>
10201103	Ø 50 Ø 32	90° gri	<b>160</b>
10201104	Ø 50 Ø 40	90° gri	<b>180</b>
10201105	Ø 50 Ø 50	90° gri	<b>150</b>
10201112	Ø 50 Ø 50	90° gri	<b>160</b>
10201114	Ø 75 Ø 75	90° gri	<b>220</b>
10201138	Ø 110 Ø 50	90° gri	<b>290</b>
10201140	Ø 110 Ø 75	90° gri	<b>350</b>
10201144	Ø 110 Ø 110	90° gri	<b>390</b>
10201153	Ø 125 Ø 110	90° gri	<b>550</b>
10201154	Ø 125 Ø 125	90° gri	<b>650</b>
10201163	Ø 125 Ø 125	90° gri	<b>890</b>
10201164	Ø 160 Ø 125	90° gri	<b>950</b>
10201165	Ø 160 Ø 160	90° gri	<b>990</b>



102014

## Tl me gomine

Kodi	Permasa	Lloji	Çmimi
10201402	Ø 50	Me tape fundore	<b>250</b>
10201404	Ø 75	Me tape fundore	<b>350</b>
10201408	Ø 110	Me tape fundore	<b>490</b>
10201409	Ø 125	Me tape fundore	<b>590</b>





102012



### Reduksion gote

Kodi	Permasa	Ngjyra	Çmimi
10201200	Ø 40 Ø 32	gri	<b>80</b>
10201202	Ø 50 Ø 40	gri	<b>100</b>
10201208	Ø 75 Ø 50	gri	<b>120</b>
10201230	Ø 110 Ø 50	gri	<b>150</b>
10201232	Ø 110 Ø 75	gri	<b>160</b>
10201253	Ø 160 Ø 110	gri	<b>390</b>
10201254	Ø 160 Ø 125	gri	<b>450</b>

102022



### Tape fundore me gomine

Kodi	Permasa	Ngjyra	Çmimi
10202200	Ø 32	gri	<b>30</b>
10202201	Ø 40	gri	<b>30</b>
10202202	Ø 50	gri	<b>30</b>
10202204	Ø 75	gri	<b>60</b>
10202208	Ø 110	gri	<b>80</b>
10202209	Ø 125	gri	<b>150</b>
10202210	Ø 160	gri	<b>220</b>

102023



### Manikote me gomine

Kodi	Permasa	Ngjyra	Çmimi
10202300	Ø 32	gri	<b>130</b>
10202301	Ø 40	gri	<b>130</b>
10202302	Ø 50	gri	<b>130</b>
10202304	Ø 75	gri	<b>250</b>
10202339	Ø 90	gri	<b>250</b>
10202308	Ø 110	gri	<b>290</b>
10202309	Ø 125	gri	<b>490</b>

100237



### Saracineske

Kodi	Permasa	Ngjyra	Çmimi
10023700	Ø 20	gri	<b>990</b>
10023701	Ø 25	gri	<b>1.500</b>
10023702	Ø 32	gri	<b>1.550</b>
10023703	Ø 40	gri	<b>2.500</b>
10023704	Ø 50	gri	<b>2.900</b>
10023705	Ø 63	gri	<b>4.500</b>



**PRODUKTE FAMILJARE**

**DHE OUTDOOR**

**Dryn bronzi me kombinim**

Kodi	Permasa	Çmimi
<b>BLK1030</b>	28 mm	<b>790</b>
<b>BLK1032</b>	38 mm	<b>990</b>

**Dryn bronzi i gjate me 3 celsa**

Kodi	Permasa	Çmimi
<b>BLK1010</b>	30 mm	<b>590</b>
<b>BLK1012</b>	40 mm	<b>790</b>
<b>BLK1014</b>	50 mm	<b>1.290</b>
<b>BLK1016</b>	60 mm	<b>1.890</b>

**FISHEK BRAVE SATIN**

Kodi	Permasa	Çmimi
<b>BLK1070</b>	54 (27/27) mm	<b>890</b>
<b>BLK1072</b>	60 (30/30) mm	<b>900</b>
<b>BLK1074</b>	65 (35/35) mm	<b>950</b>
<b>BLK1076</b>	70 (30/40) mm	<b>990</b>
<b>BLK1078</b>	75 (30/45) mm	<b>1.100</b>
<b>BLK1080</b>	80 (40/40) mm	<b>1.150</b>
<b>BLK1082</b>	80 (30/50) mm	<b>1.150</b>
<b>BLK1084</b>	90 (30/60) mm	<b>1.250</b>
<b>BLK1085</b>	90 (40/50) mm	<b>1.250</b>

**FISHEK BRAVE BRONZI**

Kodi	Permasa	Çmimi
<b>BLK1050</b>	54 (27/27) mm	<b>850</b>
<b>BLK1052</b>	60 (30/30) mm	<b>850</b>
<b>BLK1054</b>	65 (35/35) mm	<b>890</b>
<b>BLK1055</b>	70 (30/40) mm	<b>950</b>
<b>BLK1056</b>	75 (30/45) mm	<b>990</b>
<b>BLK1057</b>	80 (40/40) mm	<b>1.100</b>
<b>BLK1058</b>	80 (30/50) mm	<b>1.100</b>
<b>BLK1059</b>	90 (30/60) mm	<b>1.150</b>
<b>BLK1060</b>	90 (40/50) mm	<b>1.150</b>

**Celes per dryn**
**BLK1092**

• BLK1100



Çmimi  
**95**

**Celes reserve per fishek**
**BLK1090**

• BLK1050 - BLK1085



Çmimi  
**120**



**FISHEK BRAVE BRONZI ME 3 CELESA**



Kodi	Permasa A B C D	Çmimi
<b>B68</b>	68 / 26 - 10 - 32 mm	<b>950</b>
<b>B68V</b>	68 / 26 - 10 - 32 mm (Blister)	<b>990</b>

**FISHEK BRAVE SATIN**

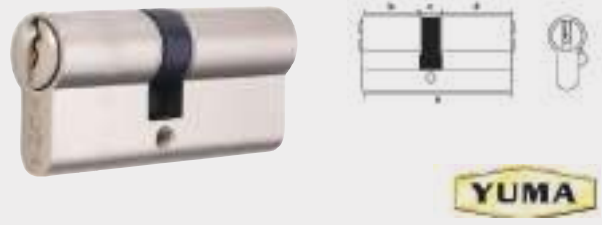

Kodi	Permasa A B C D	Çmimi
<b>B62S</b>	62 / 26 - 10 - 26 mm	<b>890</b>
<b>B68S</b>	68 / 26 - 10 - 32 mm	<b>950</b>
<b>B83S</b>	83 / 33 - 10 - 40 mm	<b>1.290</b>

**FISHEK BRAVE SATIN**



Kodi	Permasa A B C D	Çmimi
<b>B90S</b>	90 / 35 - 10 - 45 mm	<b>1.390</b>
<b>B100S</b>	100 / 40 - 10 - 50 mm	<b>1.490</b>

**FISHEK BRAVE BRONZI ME 3 CELESA**



Kodi	Permasa A B C D	Çmimi
<b>B68B</b>	68 / 26 - 10 - 32 mm(Blister)	<b>1.100</b>
<b>B68BT</b>	68 / 26 - 10 - 32 mm (Me Bllokues)	<b>1.190</b>

**FISHEK BRAVE SATIN ME 3 CELESA**



Kodi	Permasa	Çmimi
<b>B68BS</b>	68 / 26 - 10 - 32 mm(Blister)	<b>1.100</b>
<b>B68BTS</b>	68 / 26 - 10 - 32 mm(Me Bllokues)	<b>1.190</b>
<b>B68B2TS</b>	100 / 40 - 10 - 50 mm (Me 2 Bllokues)	<b>1.250</b>

**FISHEK BRAVE SATIN GJYSEM ME 2 CELESA**



Kodi	Permasa A B C D	Çmimi
<b>B41S</b>	41 / 26 - 10 - 5 mm	<b>690</b>
<b>B55S</b>	55 / 40 - 10 - 5 mm	<b>850</b>

**FISHEK BRAVE BRONZI KOMPJUTERIK ME 3 CELESA**



Kodi	Permasa	Çmimi
<b>B68BK</b>	68 mm bronzi	<b>990</b>
<b>B68BTK</b>	68 mm bronzi (Me Bllokues)	<b>1.100</b>

**FISHEK BRAVE SATIN KOMPJUTERIK ME 3 CELESA**



Kodi	Permasa	Çmimi
<b>B68BSK</b>	68 mm nikeli	<b>900</b>
<b>B68BTSK</b>	68 mm nikeli (Me Bllokues)	<b>1.100</b>
<b>B90BS</b>	90 mm nikeli	<b>1.590</b>

### FISHEK BRAVE ME LEVE ME 3 CELESA

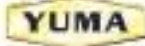

Kodi	Permase	Çmimi
B41MS	41 mm(Satin)	<b>790</b>
B68MK	68 mm(Bronz)	<b>990</b>
B68MSK	68 mm (Satin)	<b>990</b>
B90MSK	90 mm (Satin Kompjuterik)	<b>1.490</b>

### FISHEK BRAVE KOMPJUTERIK ME LEVE ME 3 CELESA

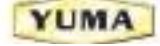

Kodi	Permase	Çmimi
B68BMK	68 mm(Bronzi)	<b>1.100</b>
B68BMSK	68 mm (Satin)	<b>1.100</b>
B68BTMK	68 mm (Bronzi me bllokues)	<b>1.200</b>
B68BTMSK	68 mm (Satin me bllokues)	<b>1.200</b>
B90BMSK	90 mm (Satin)	<b>1.690</b>

### FISHEK BRAVE, 3 CELESA ME NGJYRA ME 6 KUNJA

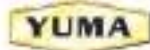

Kodi	Permase	Çmimi
B68BNP6	68 mm	<b>1.490</b>
B68BMNP6	68 mm(Kompjuterik)	<b>1.690</b>

### BRAVE QEPENI ME 2 CELESA

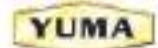

Kodi	Permase	Çmimi
600.ak	14 cm (oval e zeze)	<b>1.250</b>
601.ak	12 cm (oval e zeze)	<b>1.250</b>
602.ak	14 cm (katrore e zeze)	<b>1.250</b>
600.3m.ak	14 cm (oval e zeze me 3 fisheke)	<b>1.250</b>

### DOREZE DERE TUALETI

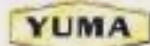

Kodi	Permase	Çmimi
709-A	Kunje dyersh kabine dushi	<b>890</b>
709-K	Shul dyersh kabine dushi	<b>790</b>
709-M	Menteshe kabine dushi	<b>650</b>

### KOKE FISHEKU ME CELESA

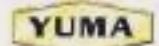

Kodi	Materiali	Çmimi
608	Bronzi	<b>650</b>

### ROZETE NE FORME CELESI M5

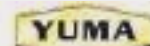

Kodi	Permase	Çmimi
721	Klasike	<b>300</b>
722	Rrethore	<b>450</b>
723	Katrore	<b>450</b>

### SHENJUES METALI ME KOKE

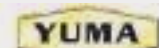

Kodi	Permase	Çmimi
790S	I zi / rrumbullake	<b>79</b>
790M	Blu / rrumbullake	<b>79</b>
790K	I kuq / rrumbullake	<b>79</b>
791S	I zi / katrore	<b>79</b>
791M	Blu / katrore	<b>79</b>
791K	I kuq / katrore	<b>79</b>

### BRAVE DYERSH ALUMINI

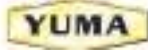

Kodi	Permasa	Çmimi
SD20	20 mm	<b>750</b>
SD25	25 mm	<b>750</b>
SD35	35 mm	<b>690</b>
SD40	40 mm	<b>790</b>
SD45	45 mm	<b>790</b>

### BRAVE DYERSH ME FISHEK SATIN ME 3 CELESA



Kodi	Permasa	Çmimi
635	35 mm	<b>1.590</b>
640	40 mm	<b>1.590</b>
645	45 mm	<b>1.590</b>

### BRAVE DYERSH TE BRENDSHME SATIN



Kodi	Permasa	Çmimi
604	35 mm	<b>690</b>
613	40 mm	<b>750</b>
614	45 mm	<b>750</b>

### MEKANIZEM HIDRAULIK PER DYER



Kodi	Permasa	Çmimi
YM-712	25 - 45 kg	<b>1.690</b>
YM-713	40 - 60 kg	<b>2.290</b>
YM-714	60 - 85 kg	<b>2.990</b>
YM-715	80 - 100 kg	<b>4.500</b>

### BRAVE DYERSH ME 3 KUNJA SIGURIE

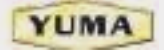

**890**  
**SD45.3M**

Permasa

45 mm

### BRAVE DYERSH ME 3 KUNJA SIGURIE DHE FISHEK SATIN

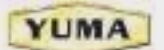

**180**  
**645C.3M**

Permasa

35 mm

### BRAVE DYERSH TUALETI SATIN

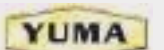

Kodi	Permasa	Çmimi
607	40 mm	<b>690</b>
615	45 mm	<b>750</b>

### MEKANIZEM HIDRAULIK ECO PER DYER



Kodi	Çmimi
YMK-742	<b>1.590</b>
YMK-743	<b>1.690</b>
YMK-744	<b>2.390</b>



**PISTON SIGURIE MEKANIK**

**1.100**

729



Per dyer

mekanike

**DOREZ MEKANIKE ME MBAJTESE GOME TE ZEZE**

**2.290**

716



Per dyer

mekanike

**SHUL DYERSH**



Kodi	Materiali	Çmimi
701	Bronzi	<b>590</b>
702	Nikel	<b>590</b>

**SHUL DYERSH ME DOREZE**



	Ngjyra	Çmimi
724	E bardhe	<b>190</b>
724K	Kafe	<b>220</b>
724D	E bardhe (Me Buton)	<b>250</b>
724KD	Kafe (Me Buton)	<b>290</b>

**SET FISHEKE BRAVE ME 2 CELESA**



Kodi	Permasa	Çmimi
725	Katror prej celiku	<b>2.550</b>
745	Me celes per sirtare	<b>3.650</b>

**KYC SIRTARI ME 2 CELESA**

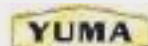

Kodi	Permasa	Çmimi
YMK-708 - K	Katrorre	<b>90</b>
YMK-708 - O	Ovale	<b>120</b>
YMK-708 - M	Me kunj sigurie	<b>135</b>

**KAVO BICIKLETE ME DRYN DHE 3 CELESA**

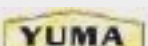

Kodi	Permasa	Çmimi
736	10mm x 170cm e kompletuar	<b>6.490</b>
Z-1	10mm x 170cm vetem zinxhir	<b>4.950</b>

**KAVO BICIKLETE ME DRYN DHE 3 CELESA**

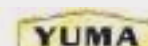

Kodi	Permasa	Çmimi
737	10mm x 170cm e kompletuar celiku	<b>4.890</b>
Z-2	10mm x 170cm vetem zinxhir celiku	<b>3.790</b>

### DRYN QEPENI



Kodi	Permasa	Çmimi
YM-1060R	60 mm	<b>790</b>
YM-1070R	70 mm	<b>890</b>
YM-1080R	80 mm	<b>950</b>
YM-1090R	90 mm	<b>990</b>

### DRYN NIKELI PER QEPENA



Kodi	Permasa	Çmimi
YMK-1260R	60 mm	<b>590</b>
YMK-1270R	70 mm	<b>690</b>
YMK-1280R	80 mm	<b>750</b>
YMK-1290R	90 mm	<b>850</b>

### DRYN BRONZI PER QEPENQEPENI ME RRESHQITJE AUTOMATIKE



Kodi	Permasa	Çmimi
3070	70 mm	<b>1.900</b>
3080	80 mm	<b>2.090</b>

### DRYN BRONZI PER QEPENQEPENI ME RRESHQITJE MANUALE

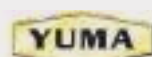

Kodi	Permasa	Çmimi
3068	70 mm	<b>1.690</b>
3079	80 mm	<b>1.850</b>

### DRYN HEKURI I VERDHE



Kodi	Permasa	Çmimi
YM-1025B	25 mm	<b>150</b>
YM-1032B	32 mm	<b>190</b>
YM-1038B	40 mm	<b>250</b>
YM-1050B	50 mm	<b>450</b>
YM-1063B	63 mm	<b>590</b>

### DRYN HEKURI I VERDHE I LYER



Kodi	Permasa	Çmimi
YMK-1220B	20 mm	<b>90</b>
YMK-1225B	25 mm	<b>100</b>
YMK-1232B	32 mm	<b>130</b>
YMK-1238B	40 mm	<b>160</b>
YMK-1250B	50 mm	<b>250</b>
YMK-1263B	63 mm	<b>350</b>

### DRYN BRONZI STANDART



Kodi	Permasa	Çmimi
2032	32 mm	<b>690</b>
2040	40 mm	<b>850</b>
2050	50 mm	<b>1.150</b>
2060	60 mm	<b>1.490</b>

### DRYN BRONZI I GJATE

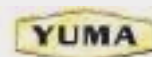

Kodi	Permasa	Çmimi
2032L	32 mm	<b>790</b>
2040L	40 mm	<b>950</b>
2050L	50 mm	<b>1.290</b>
2060L	60 mm	<b>1.690</b>



## DRYN BRONZI ME KOMBINIM



Kodi	Permasa	Çmimi
YM-2120	20 mm	<b>550</b>
YM-2125	25 mm	<b>590</b>
YM-2130	30 mm	<b>750</b>
YM-2140	40 mm	<b>1.100</b>
YM-2150	50 mm	<b>1.900</b>

## DRYN HEKURI ME KOMBINIM YMK



Kodi	Permasa	Çmimi
YMK-1325	25 mm	<b>220</b>
YMK-1332	32 mm	<b>250</b>
YMK-1338	38 mm	<b>290</b>
YMK-1350	50 mm	<b>350</b>

## DRYN BRONZI I VERDHE I GJATE



Kodi	Permasa	Çmimi
YM-1032BL	32 mm	<b>200</b>
YM-1038BL	38 mm	<b>260</b>
YM-1050BL	50 mm	<b>450</b>

## DRYN BRONZI I VERDHE I GJATE



Kodi	Permasa	Çmimi
YMK-1225BL	25 mm	<b>100</b>
YMK-1232BL	32 mm	<b>150</b>
YMK-1238BL	40 mm	<b>170</b>
YMK-1250BL	50 mm	<b>250</b>
YMK-1263BL	63 mm	<b>390</b>

## DRYN HEKURI GRI I GJATE

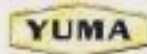

Kodi	Permasa	Çmimi
YM-1032L	32 mm	<b>190</b>
YM-1038L	38 mm	<b>250</b>
YM-1050L	50 mm	<b>450</b>

## DRYN HEKURI I GJATE



Kodi	Permasa	Çmimi
YMK-1225L	25 mm	<b>100</b>
YMK-1232L	32 mm	<b>120</b>
YMK-1238L	40 mm	<b>150</b>
YMK-1250L	50 mm	<b>250</b>
YMK-1263L	63 mm	<b>330</b>

## DRYN HEKURI GRI

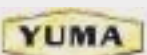

Kodi	Permasa	Çmimi
YM-1020	20 mm	<b>150</b>
YM-1025	25 mm	<b>170</b>
YM-1032	32 mm	<b>190</b>
YM-1038	40 mm	<b>250</b>
YM-1050	50 mm	<b>390</b>
YM-1063	43 mm	<b>590</b>

## DRYN HEKURI



Kodi	Permasa	Çmimi
YMK-1220	20 mm	<b>85</b>
YMK-1225	25 mm	<b>100</b>
YMK-1232	32 mm	<b>120</b>
YMK-1238	40 mm	<b>150</b>
YMK-1250	50 mm	<b>220</b>
YMK-1263	63 mm	<b>330</b>



### DRYN BRONZI PROFI ME 3 ÇELESJA



Kodi	Permasa	Çmimi
DBPL0202	20 mm	<b>250</b>
DBPL0302	30 mm	<b>540</b>
DBPL0402	40 mm	<b>690</b>
DBPL0502	50 mm	<b>990</b>
DBPL0602	60 mm	<b>1.290</b>
DBPL0702	70 mm	<b>1.390</b>

### DRYN HEKURI ME 3 ÇELESJA



Kodi	Permasa	Çmimi
DIPL0301	32 mm	<b>190</b>
DIPL0401	38 mm	<b>250</b>
DIPL0501	50 mm	<b>350</b>
DIPL0601	63 mm	<b>490</b>
DIPL0701	75 mm	<b>690</b>

### DRYN BRONXI ME 3 ÇELESJA



Kodi	Permasa	Çmimi
DBBPL0602	60 mm	<b>1.250</b>
DBBPL0702	70 mm	<b>1.590</b>
DBBPL0802	80 mm	<b>1.990</b>
DBBPL0902	90 mm	<b>2.350</b>

### DRYN HEKURI PROFI ME CELESJA DHE KUNDER UJIT



**450**  
WPD9455

Permasa

55 mm

### DRYN BRONZI ME 3 CELESJA



Kodi	Permasa	Çmimi
WPD1420	20 mm	<b>190</b>
WPD1440	40 mm	<b>390</b>
WPD1460	60 mm	<b>790</b>

### DRYN BRONZI ME QAFE TE GJATE ME 3 CELESJA



**650**  
WPD2450

Permasa

50 mm

### DRYN BRONZI ME 3 KODE



**330**  
WPD3423

Permasa

3 x 20 mm

### DRYN CELIKU ME 3 CELESJA



**490**  
WPD450

Permasa

50 mm

### KAVO BIKIKLETE ME KOD 4-SHIFROR

690

DBK21012



Permasa

10 x 1200 mm

### KAVO BIKIKLETE ME 2 ÇELESA



Kodi	Permasa	Çmimi
DBK11010	10 x 1000 m	690
DBK11210	12 x 1000 m	790

### KAVO BIKIKLETE ME 2 ÇELESA

850

DBK151201



Permasa

15 X 1200 mm

### KAVO BIKIKLETE ME 2 ÇELESA

1.350

DBK112012



Permasa

20 x 1200 mm

### KAVO BIKIKLETE ME KOD 4 SHIFROR

390

WBK2108



Permasa

8 x 1000 mm

### KAVO BIKIKLETE ME KOD 4 SHIFROR

490

WBK2110



Permasa

10 x 1200 mm

### KAVO BIKIKLETE ME 2 CELESA

450

WBK1112



Permasa

12 x 1200 mm

### KAVO BIKIKLETE I SPERDREDHUR ME 2 CELESA

690

WBK5108



Permasa

18 x 800 mm

**KAVO BIKIKLETE ZINXHIR ME 2 CELESA**



**790**  
**WBK4109**

Permasa 5.3 x 900 mm

**KAVO BIKIKLETE U ME 2 CELESA**



**890**  
**WBK6125**

Permasa 200 x 250 mm

**Dryn bronzi** **VOREL**

**77700**



Çmimi **290**

**Kavo biciklete me celes sigurie** **VOREL**

**77830**

Gjatesia 8 mm x 65 cm



Çmimi **650**

**Kavo biciklete me kod sigurie** **VOREL**

**77831**

Gjatesia 8 mm x 65 cm



Çmimi **490**

**Kavo biciklete me celes sigurie** **VOREL**

**77840**

Gjatesia 12 mm x 1.8 m



Çmimi **890**

**Kavo biciklete me kod sigurie** **VOREL**

**77845**

Gjatesia 10 mm x 1.2 m



Çmimi **890**

**Kavo biciklete me celes sigurie** **VOREL**

**77850**

Gjatesia 18 mm x 100 cm



Çmimi **950**



**Kavo motori me celes sigurie**

**77861**

Gjatesia 25 mm x 150 cm

 Çmimi  
**1.690**
**Zinxhir sigurie për dyer**

**77900**

 Çmimi  
**290**
**Kuti celesash metalike e bardhe**

**78432**

Permasa 200x160x78 mm

 Çmimi  
**1.900**
**Litar elastik për bagazhe dysh**

Kodi	Gjatesia [cm]	Çmimi
83208	80	<b>250</b>
83210	100	<b>290</b>
82315	150	<b>350</b>
82320	200	<b>450</b>

**Kandar metalik 32 kg**

**15301**

 Çmimi  
**390**
**Kandar metalik 25 kg**

**15291**

 Çmimi  
**350**
**Etiketa mbajtese celesi 12 cope**

**77930**

 Çmimi  
**190**
**Makineri Skocimi 50 mm**

**75295**

 Çmimi  
**890**

**Kuti celesash murale me kombinim** BORMANN

**BDS2000**

- Permasa: 8.7x4x12.2 cm (10 cope)



Çmimi  
**2.490**

**Kasaforte Dixhitale** BORMANN

**BDS3000**

- Kuti dixhitale me celes
- Dimensionet: 31x20x20 cm
- E sigurte per hotele dhe shtepi



Çmimi  
**5.900**

**Kasaforte Dixhitale** BORMANN

**BDS2300**

- Kuti dixhitale me bllokim elektrik dhe celes
- Dimensionet: 23x17x17 cm
- E sigurte per hotele dhe shtepi



Çmimi  
**4.900**

**Kasaforte Dixhitale** BORMANN

**BDS6000**

- Kuti dixhitale me bllokim elektrik dhe celes
- Dimensionet: 43x38x20 cm
- E sigurte per hotele dhe shtepi



Çmimi  
**9.500**

**KASAFORTE DIXHITALE** INGCO

**4.900**

**ESF2002**



Vellimi  
Permasa

11 Lt  
20x31x20 cm

**KASAFORTE DIXHITALE** INGCO

**6.500**

**ESF2502**



Vellimi  
Permasa

19 Lt  
25x35x25 cm

**KASAFORTE DIXHITALE** INGCO

**8.500**

**ESF3502**



Vellimi  
Permasa

27 Lt  
20x43x35 cm

**KASAFORTE DIXHITALE** INGCO

**9.900**

**ESF5002**



Vellimi  
Permasa

52 Lt  
50x35x33 cm

**Kuti postare e zeze**



**BMB1003**

- Permasat: 300x200x50 mm



Çmimi  
**1.790**

**Kuti postare gri**



**BMB1001**

- Permasat: 300x200x50 mm



Çmimi  
**1.690**

**Kuti Postare Gri**



**78541**

285 x 200 x 60 mm



Çmimi  
**1.590**

**Kuti Postare e Zeze**



**78555**

- 360 x 260 x 80 mm



Çmimi  
**1.990**

**Kuti per ndihmen e shpejte**



**BFB2000**

- Dimensionet: 32 x 22 x 8 cm
- Ngjyra e bardhë



Çmimi  
**2.990**

**Mbajtese monitori 13"-27"**



**BTV1500**

- Koke e levizshme
- Me bazament



Çmimi  
**1.690**

**Mbajtese muri per TV 26-55**



**BTV1200**

- Me profil 49 mm
- Kapacitet mbajtje 45 Kg



Çmimi  
**1.950**

**Mbajtese muri per TV 13-42**



**BTV1050**

- Me profil 40-375 mm



Çmimi  
**1.990**



**Mbajtese muri per TV 26-55**



**BTV1100**

- Me profil 60-475 mm



Çmimi  
**3.900**

**Mbajtese televizori e levizshme**



**BTV1300**

- Permasat: 26-60 "
- Kapaciteti: 50 kg



Çmimi  
**9.900**

**Peshore elektronike**



**69204**

- Kapaciteti deri ne 180 kg



Çmimi  
**1.690**

**Peshore elektronike me bluetooth**



**69205**

- Kapaciteti deri ne 180 kg



Çmimi  
**1.490**

**Hekur rrobash 2800 W, 320 ml**



**68115**



Çmimi  
**3.900**

**Pastruese dyshemje me bateri**



**23.520.40**

- Fuqia: 18 V
- Depozita: 20 L
- Kapaciteti: 1800m<sup>2</sup>/h
- Pesha: 10.3 Kg
- (Vetem trup)



Çmimi  
**29.900**

**Pastrues xhamash me bateri**



**34.371.00**

- Fuqia: 18 V
- Depozita: 10 L
- Me avull brillianto
- Pa karbonica (Vetem trup)



Çmimi  
**5.900**

**Fshese dore me bateri**



**23.471.80**

- Fuqia: 18 V
- Depozita: 0.6 L
- 2 ne 1 TE-SV
- (Vetem trup)



Çmimi  
**14.900**

**Blender elektrik per smoothie**

**LUND**

**67703**



Çmimi  
**4.990**

**Ngrohës uji elektrik me xham**

**LUND**

**68173**

Fuqia: 2.200W  
Depozite: 1.7 Lt



Çmimi  
**3.990**

**Toster me pjata**

**BORMANN**

**BHA3300**

- Fuqia: 2000 W
- Pjata: 30x24 cm



Çmimi  
**6.500**

**Furnelle elektrike, 2 pllaka qermike**

**BORMANN**

**BEP3200**

- Fuqia: 2500 W
- Permasa: 185x155 mm



Çmimi  
**5.200**

**Sobe elektrike me furre dhe pllaka**

**BORMANN**

**BEP4010**

- Fuqia: 3700 W
- 2 pllaka Titanium



Çmimi  
**12.500**

**Shtrydhëse agrumesh profesionale**

**BORMANN**

**BFJ2000**



Çmimi  
**6.600**

**Brumatrice TITANIUM**

**BORMANN**

**BHA1900**

- Fuqia: 1300W
- Depozite inoxi: 5 L
- 6 nivele shpejtesie



Çmimi  
**12.500**

**Grirëse elektrike mishi dhe perimesh**

**BORMANN**

**BHA1820**

- Fuqia: 2000 W



Çmimi  
**15.900**

**CORDLESS**  
Kitchen Appliance





### Blender me bateri

**KEJB052R**

- Fuqia: 300 W
- Tensioni i baterisë: 16 V
- Bateria: 2000 mAh
- Kapaciteti: 1.5 Lt
- 2 nivele shpejtësie
- 4 tehe inoksi, enë qelqi
- Ekran LED, 1 bateri 2.0Ah, 1 karikues



**Çmimi**  
**6.590**

**E RE**

**CORDLESS**  
Kitchen Appliance

### Blender me bateri

**KMJB047R**

- Fuqia: 100 W
- Tensioni i baterisë: 16 V
- Bateria: 2000 mAh
- 5 nivele shpejtësie
- 2 tehe inoksi, Ekran LED
- Shufra e përzierjes SUS, vetëm trup



**Çmimi**  
**2.890**

**E RE**

**CORDLESS**  
Kitchen Appliance

### Set blender me bateri 5 në 1

**KEJB056R**

- Fuqia: 100 W
- Tensioni i baterisë: 16 V
- Bateria: 2000 mAh
- 2 tehe inoksi
- Enë për copëtim 500 ml
- 1 rrahëse, 1 gotë matëse, shkumues qumështi
- Ekran LED, 1 bateri 2.0Ah, 1 karikues



**Çmimi**  
**7.490**

**E RE**

**CORDLESS**  
Kitchen Appliance

### Mikser me bateri

**KEMX023R**

- Fuqia: 100 W
- Tensioni i baterisë: 16 V
- Bateria: 2000 mAh
- 7 nivele shpejtësie
- 2 tehe inoksi, 2 rrahëse
- 1 shkumues qumështi
- 1 bateri 2.0Ah, 1 karikues



**Çmimi**  
**6.900**

**E RE**

**CORDLESS**  
Kitchen Appliance

### Përpunues ushqimi me bateri

**KEMG027R**

- Fuqia: 250 W
- Tensioni i baterisë: 16 V
- Bateria: 2000 mAh
- 3 funksione, kapaciteti 1.25 L
- 2 thika për prerje dhe copëtim
- Nivelet e funksionimit: P-0-1-2
- 1 teh prerës, 1 teh rrahje, 1 bateri 2.0Ah, 1 karikues



**Çmimi**  
**6.900**

**E RE**

**CORDLESS**  
Kitchen Appliance

### Karikues baterie

**HEDC006B**

- Tensioni i hyrjes: 220-240 V
- Tensioni i daljes: 16 V
- Rryma 1.3 A



**Çmimi**  
**790**

**E RE**

**CORDLESS**  
Kitchen Appliance

### Bateri Lithium

**HMDC005S**

- Tensioni i baterisë: 16 V
- Bateria Litium: 2Ah
- I përshtatshëm për të gjitha produktet e serisë 16V



**Çmimi**  
**1.900**

**E RE**

**CORDLESS**  
Kitchen Appliance

### Set blender me bateri 5 në 1

**KMJB042L**

- Fuqia: 60 W
- Tensioni i baterisë: 7.4 V
- Bateria: 1500 mAh
- 2 tehe inoksi
- Enë për copëtim 500 ml
- 1 rrahëse, 1 gotë matëse
- Shkumues qumështi



**Çmimi**  
**4.500**

**E RE**

**CORDLESS**  
Kitchen Appliance

## Blender me bateri

**KMJB022L**

- Fuqja: 120 W
- Tensioni i baterisë: 7.4 V
- Bateria: 2000 mAh
- Kapaciteti: 500 mL
- Enë kundër rrëshqitjes
- 4 tehe inoksi
- Karikues me fishë USB

**Çmimi**  
**4.500**



decalife

CORDLESS  
Kitchen Appliance

## Copëzues ushqimi me bateri

**KMMG008B**

- Fuqja: 30 W
- Tensioni i baterisë: 3.7 V
- Bateria: 1500 mAh
- Kapaciteti: 300 mL
- Enë qelqi 300 ml
- 3 tehe inoksi
- Karikues me fishë USB

**Çmimi**  
**1.990**



decalife

CORDLESS  
Kitchen Appliance

## Mikser dore me bateri

**KMMX018G**

- Fuqja: 25 W
- Tensioni i baterisë: 3.7 V
- Bateria: 1500 mAh
- 3 nivele shpejtësie
- 2 rrahëse inoksi
- Karikues me fishë USB

**Çmimi**  
**1.590**



decaDeal

CORDLESS  
Kitchen Appliance

## Mikser dore me bateri

**KMMX019G**

- Fuqja: 25 W
- Tensioni i baterisë: 3.7 V
- Bateria: 1500 mAh
- 3 nivele shpejtësie
- 2 rrahëse inoksi
- Enë qelqi për copëtim 0.3 L
- Karikues me fishë USB

**Çmimi**  
**1.990**



decaDeal

CORDLESS  
Kitchen Appliance

## Blender portabël me bateri

**KMJB035G**

- Fuqja: 30 W
- Tensioni i baterisë: 3.7 V
- Bateria: 1500 mAh
- Kapaciteti: 300 ml
- 3 nivele shpejtësie
- 2 tehe inoksi
- Karikues me fishë USB

**Çmimi**  
**1.590**



decaDeal

CORDLESS  
Kitchen Appliance

## Blender portabël me bateri

**KMJB035W**

- Fuqja: 30 W
- Tensioni i baterisë: 3.7 V
- Bateria: 1500 mAh
- Kapaciteti: 300 ml
- 3 nivele shpejtësie
- 2 tehe inoksi
- Karikues me fishë USB

**Çmimi**  
**1.590**



decaDeal

CORDLESS  
Kitchen Appliance

## Përpunues ushqimi me bateri

**KMMG005B**

- Fuqja: 200 W
- Tensioni i baterisë: 11.1 V
- Bateria: 2000 mAh
- 3 funksione
- 2 thika inoksi
- Nivelet e funksionimit: P-0-1-2
- Pastrim i lehtë thike

**Çmimi**  
**5.900**



decaPrime

CORDLESS  
Kitchen Appliance

## Set Blender 4 në 1

**KMJB024B**

- Fuqja: 100 W
- Tensioni i baterisë: 11.1 V
- Bateria: 2000 mAh
- 2 thika inoksi
- Bateria: 2000 mAh
- 1 rrahëse, 1 gotë matëse
- Shkumues qumështi

**Çmimi**  
**4.900**



decaPrime

CORDLESS  
Kitchen Appliance

## Mikser me bateri

**E RE**

**KMMX006B**

- Fuqia: 90 W
- Tensioni i baterisë: 11.1 V
- Bateria: 2000 mAh
- 7 nivele shpejtësie
- 2 rrahëse
- 2 përzjerëse
- Shkumues qumështi



**Çmimi**  
**5.900**

decaPrime

## Fshesë portative me bateri

**CORDLESS**  
Kitchen Appliance

**CMPV003W**

- Fuqia: 90 W
- Bateria: 11.1 V
- Motorr pa karbonçina
- Koha e karikimit: 4 orë
- Me kablllo karikimi USB



**Çmimi**  
**5.900**

decalife

**CMPV003B**

## Fshesë portabël me bateri

**CORDLESS**  
Kitchen Appliance

**CUCV001W**

- Fuqia: 140 W
- Bateria: 22.2 V
- Kapaciteti: 0.8 L
- Koha e karikimit: 4 orë
- Filtër HEPA



**Çmimi**  
**7.990**

decalife

## Makinë Rroje me bateri

**E RE**

**KMHS029R**

- Bateria Ni-Cd 600 mAh
- Teh çeliku
- Madhësia: 158 x 37 mm
- Gjatësia e prerjes: e rregullueshme
- Me krehër 3 mm, 6 mm, 9 mm
- Koha e punës: 50 min
- Koha e karikimit: 8 orë
- Kabull USB, furçë, shishe vaji



**Çmimi**  
**790**

## Kafetiere Moka

**KMCF023M**

- Kapaciteti: 6 filnshanë
- Dimensioni: 168 x 105 x 203 mm
- Materiali: Alumin
- Pesha: 380 g (+/- 10 g)
- Dorezë rezistente ndaj nxehtësisë



**Çmimi**  
**990**

decaDeal

## Bërës kafeje Tuke (1-4 filxhan)

**KECF030B**

- Fuqia: 500 W
- Kapaciteti: 250 ml
- Fikje automatike mbas zjerjes
- Tregues i nivelit të ujit
- Lugë mase
- Pllakë ngrohëse: SUS 304



**Çmimi**  
**2.500**

decalife

## Kafe filtër (10 filxhanë)

**KECF001B**

- Fuqia: 750 W
- Kapaciteti: 1.25 L
- Funkzion ruajtje nxehtësie
- Filtër najloni dhe lugë mase
- Buton ndezje ON/OFF
- Mbrojtje nga tharja e zjerjes
- Funkzion kundër pikimit 30 sec



**Çmimi**  
**1.990**

decaDeal

## Fritezë

**E RE**

**KEEC056M**

- Fuqia: 2000 W
- Kapaciteti: 3L
- Tensioni: 220-240 V
- Temp. e rregullueshme: 115-190°C
- Materialet: çelik inoxi
- Me mbrojtje nga mbinxehja
- Enë e brendshme e lehtë për t'u pastruar
- Shportë me dorezë të palosshme



**Çmimi**  
**4.900**



## Copëzues ushqimi

### KEMG013R

- Fuqia: 400 W
- Kapaciteti: 1.5 L
- Motorr me thurrrje bakri
- Thikë me tre helika
- Buton me prekje
- Copëzon edhe akullin



Çmimi  
3.590



## Copëzues ushqimi

**E RE**

### KEMG011B

- Fuqia: 300 W
- Tensioni: 220-240 V
- Kapaciteti: 2 Lt
- 2 nivele shpejtësie
- Enë qelqi, trup inoxi
- Teh i mprehtë me 2 shtresa
- E lehtë për tu pastruar



Çmimi  
2.190

## Grirëse mishi

### KEMG021B

- Fuqia: 600 W
- Kapaciteti: 1.5 kg/min
- Bazament kundra rrëshkitjes
- Rotullim thike para dhe mbrapa
- 1 thikë, 2 pjata dhe 1 kallup



Çmimi  
4.990



## Mikser dore

### KEMX001W

- Fuqia: 200 W
- 6 nivele shpejtësie dhe turbo
- 2 funksione: rrahje dhe përzjerje



Çmimi  
1.790



## Mikser dore

### KEMX016W

- Fuqia: 120 W
- Tensioni: 220-240 V
- 7 nivele shpejtësie
- 2 tehe inoxi
- 2 rrahëse



Çmimi  
990

## Mikser me enë inoxi

### KEMX003B

- Fuqia: 600 W
- Enë inoxi: 5 L
- 7 nivele shpejtësie
- Kokë mikseri e lëvizshme
- Mbrojtëse transparente
- Aksesor rrahje dhe përzjerje



Çmimi  
7.990



## Zjerës vezësh

### KEEG003W

- Fuqia: 350 W
- Kapaciteti: 7 vezë
- Tregues fuqie
- Tabaka e çmontueshme



Çmimi  
1.990



## Shkumues qumështi

### KECF015W

- Fuqia: 550 W
- Kapaciteti për ngrohje: 210 mL
- Kapaciteti për shkumim: 80 mL
- Materiali: çelik karboni
- Koha e shkumimit: 2 min

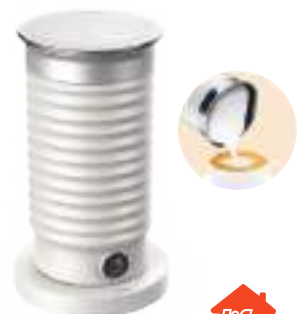

Çmimi  
3.900



### Blender elektrik

#### KEJB045L

- Fuqia: 650 W
- Tensioni: 220-240 V
- Kapaciteti: 1.5 Lt
- 2 nivele shpejtësie
- 6 tehe inoksi, enë qelqi
- Motor me tela bakri
- Kundër rrëshqitjes së këmbëve



**Çmimi**  
**3.900**

### Blender elektrik

**E RE**

#### KEJB001W

- Fuqia: 400 W
- Kapaciteti: 1.5 Lt
- 2 nivele shpejtësie
- Tehe inoksi
- Enë plastike
- Kundër rrëshqitjes



**Çmimi**  
**2.500**

### Ngrohës uji elektrik

#### KEKT002B

- Fuqia: 1500-1800 W
- Kapaciteti: 1.5 L
- Materiali: inoks
- Mbrojtje nga shterimi
- Me llambë treguese
- Filtër i integruar
- Fikje automatike



**Çmimi**  
**1.590**

decaDeal

### Ngrohës uji elektrik

#### KEKT004W

- Fuqia: 1850-2200 W
- Kapaciteti: 1.7 L
- Materiali: inoks
- Mbrojtje nga shterimi
- Me llambë treguese
- Filtër i integruar
- Fikje automatike



**Çmimi**  
**1.990**

decalife

### Pjekëse halogjene

**E RE**

#### KEEC072W

- Fuqia: 1200-1400 W
- Kapaciteti: 12L
- Tensioni: 220-240 V
- Tas qelqi rezistent ndaj nxehtësisë
- Mbrojtje e ulët, mbajtje e lartë
- 1 kapëse
- Gatuesi 2-3 herë më shpejt se furra standarte
- Kursen deri në 60% energji



**Çmimi**  
**4.500**

decalife

### Air fryer

**E RE**

#### KEEC036V

- Fuqia: 1400 W
- Kapaciteti: 3.5 Lt
- Mbrojtje nga mbinxehja
- Depozitë që nuk ngjit
- Temp. e rregullueshme 80-200°C
- Këmbë që nuk rrëshqasin



**Çmimi**  
**3.990**

decalife

### Shtrydhëse frutash

#### KEJC006W

- Fuqia: 40 W
- Kapaciteti: 0.5 L
- Motor rrotullues në dy drejtime
- Kupë transparente



**Çmimi**  
**1.590**

decaDeal

### Shtrydhëse frutash

**E RE**

#### KEJC008B

- Fuqia: 160 W
- Trup inoksi
- Sistem kundër rrëshqitjes
- Filtër i çmontueshëm
- E lehtë për tu pastruar
- Dorezë e gomuar



**Çmimi**  
**3.590**

decalife

## Toster

### KEEC046B

- Fuqia: 750 W
- Kapaciteti i pllakës: 215 x 125 mm
- Temp. e pllakës së gatimit: 180±10°C
- Koha e nxehtjes: 90-150 sek
- Kontroll me termostat
- Veshje kundër ngjites
- Bazament kundër rrëshqitjes



Çmimi  
1.590



## Toster

### KEEC047R

- Fuqia: 750 W
- Kapaciteti i pllakës: 215 x 125 mm
- Temp. e pllakës së gatimit: 180±10°C
- Koha e nxehtjes: 90-150 sek
- Kontroll me termostat
- Veshje kundër ngjites
- Bazament kundër rrëshqitjes



Çmimi  
1.590



## Toster

### KEEC058W

- Fuqia: 650 W
- Kapaciteti i pllakës: 142 x 142 mm
- Temp. e pllakës së gatimit: 200±10°C
- Koha e nxehtjes: 3 min
- Kontroll me termostat
- Veshje kundër ngjites
- Me llambë treguese



Çmimi  
1.990



## Pllakë Grill/ Pllakë Waffle

### KMEC059B

- Pllakë për KEEC058W, KUEC058W
- Pllakë kundër ngjites
- Kapaciteti i pllakës: 142 x 142 mm

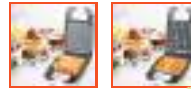

Çmimi  
490



### KMEC061B



## Pllakë Ovale/ për petulla

### KMEC062B

- Pllakë për KEEC058W, KUEC058W
- Pllakë kundër ngjites
- Kapaciteti i pllakës: 142 x 142 mm



### KMEC065B



Çmimi  
490



## Pllakë Rumbullake (për krepja)

### KMEC063B

- Pllakë për KEEC058W, KUEC058W
- Pllakë kundër ngjites
- Kapaciteti i pllakës: 142 x 142 mm



Çmimi  
490



## Thekëse buke me 2 anë

### KETS001W

- Fuqia: 700 W
- Kapaciteti për dy feta
- 6 nivele thekjeje
- Zgara të lëvizshme



Çmimi  
1.590



## Thekëse buke me 4 anë

### KETS011B

- Fuqia: 1200-1400 W
- Kapaciteti për katër feta
- 7 nivele thekjeje
- Funkzioni: ngrohje dhe shkrirje
- Zgara të lëvizshme



Çmimi  
2.690





### Tenxhere presioni Multi Cooker

**E RE**

#### KEER041M

- Fuqia: 900 W
- Kapaciteti: 5L
- Tensioni: 220-240 V
- 9 funksione të parakonfiguruar
- Veshje jo ngjitëse
- 1 lugë, 1 filnxhan matës
- Kabull rryme
- Ekran LED



**Çmimi**  
**6.900**

### Tenxhere presioni

#### KMER018M

- Kapaciteti: 5.5 L
- Presioni: 60-80 kPa
- Tensioni i baterisë: 220-240 V
- Materiali: aliazh alumini A3003
- Lustrim i jashtëm
- Dorezë bakeliti



**Çmimi**  
**3.490**



**decaDeal**

### Tenxhere

#### KMEP007B

- Madhësia: 16 x 7 cm
- Trashësia: 2.0 mm
- Pesha: 750 g
- Materiali: alumin
- Veshje jo ngjitëse me dy shtresa
- Me kapak xhami të temperuar



**Çmimi**  
**990**

**decalife**

### Tenxhere

**E RE**

#### KMEP009B

- Madhësia: 24 x 11 cm
- Trashësia: 2.3 mm
- Pesha: 1.3 Kg
- Materiali: alumin
- Veshje jo ngjitëse me dy shtresa



**Çmimi**  
**1.890**

**decalife**

### Set kuzhine me tenxhere

**E RE**

#### KMEP006B

- Set enë gatimi, 11 copë
- Tenxhere 16 x 7 cm me kapak
- Tenxhere 20 x 8 cm me kapak
- Tenxhere 22 x 10 cm me kapak
- Tenxhere 22 x 4 cm
- 4 spatulla najloni
- Trashësia: 2.1 mm, materiali: alumin



**Çmimi**  
**3.900**

**decalife**

### Tigan për skuqje

**E RE**

#### KMEP001B

- Madhësia: 20 cm
- Trashësia: 2.5 mm
- Pesha: 410 g
- Materiali: alumin
- Veshje jo ngjitëse me dy shtresa



**Çmimi**  
**890**

**decalife**

### Tigan për skuqje

**E RE**

#### KMEP002B

- Madhësia: 24 cm
- Trashësia: 2.5 mm
- Pesha: 553 g
- Materiali: alumin
- Veshje jo ngjitëse me dy shtresa



**Çmimi**  
**990**

**decalife**

### Set enë kuzhine (6 copë)

#### KMTT045B

- Madhësia: najlon, material jo ngjitës
- Lugë me vrime: 30 x 6,5 x 5 cm
- Lugë e fortë: 30 x 6,5 x 5 cm
- Lugë: 30 x 9,5 x 7,5 cm
- Lugë makaronash: 29,5 x 6,5 x 5,5 cm
- Rrotullues me vrime: 31 x 9 x 4,5 cm
- Spatulat: 30 x 9 x 4,5 cm



**Çmimi**  
**750**

**decalife**

## Spatul silikon

**E RE**

**KMTT071R**

- Materiali silikon
- Madhësia: 20.5 x 3.8 cm
- Pesha: 35 g
- Rezistencë ndaj temp. -30°C deri 230°C
- I lehtë për t'u përdorur



**Çmimi**  
**150**



## Presëse pice

**E RE**

**KMTT068B**

- Materiali: inoks
- Dorezë e parrëshqitshme
- Perfekt për prerjen e picës, byrekut, brumit të ëmbëlsirave, etj



**Çmimi**  
**290**



## Shtrydhëse limoni

**E RE**

**KMTT069Y**

- Materiali alumin
- Madhësia: 22 x 7.5 cm
- Pesha: 175 g
- I lehtë për t'u përdorur



**Çmimi**  
**450**



## Prerëse patatesh

**E RE**

**KMTT085W**

- Materiali PP+S/S 201
- Madhësia: 9.6 x 8 x 13.3 cm
- Pesha: 192 g
- Tehet inox
- I dobishëm dhe për përbërës si karrotat, kastravecet, qepët, vezët, djathin, etj



**Çmimi**  
**490**



## Rrahëse inoksi

**KMTT064M**

- Materiali: çelik inoksi
- Përmasat: 30,5 x 6,5 cm
- Pesha: 53.7 g
- Trashësia: 1.4 mm
- I lehtë për t'u pastruar



**Çmimi**  
**150**



**KMTT065M**

## Grirëse qepe manuale

**KMTT084W**

- Materiali: PP+PS+ABS+TPR+S/S 18/0
- Madhësia: 12,5 x 9,3 cm
- Pesha: 195 g
- Kapaciteti: 400 ml
- Tehe inox për prerje efikase
- Kundër rrëshqitjes
- Nuk kërkohet energji elektrike



**Çmimi**  
**450**



## Termus portabel

**E RE**

**KMTT024W**

- Kapaciteti: 566 ml
- Materiali: inoks
- Madhësia: 88 x 175 mm
- Pesha: 300g
- I sigurt në larës enësh
- Me izolim të dyfishtë vakum për të mbrojtur temperaturën



**Çmimi**  
**1.490**



## Formë pjekje keku

**E RE**

**KMTT081B**

- Materiali çelik karboni
- Madhësia: 2.5 x 10.5 cm
- Pesha: 459 g
- Trashësia: 0.4 mm
- Rezistencë ndaj temp. 230°C
- E përkryer për ëmbëlsirat



**Çmimi**  
**450**



## Peshore kuzhine me ekran

### KMTT014P

- Kapaciteti: 2-5000 g
- Fikje automatike
- Ekran LCD
- Temperatura e punës: 5-60°C
- Me buton ON/OFF



**Çmimi**  
1.490



## Peshore kuzhine

### KMTT012B

- Kapaciteti: 2-5000 g
- Fikje automatike
- Ekran LCD
- Temperatura e punës: 5-60°C
- Me buton ON/OFF
- Me enë të përfshirë



**Çmimi**  
1.590



## Fshesë portative 2 në 1

### CECV006B

- Fuqia: 600 W
- Fshesë portative
- Qese pluhuri: 0.6 L
- Gjatësia e kabullit: 3.5 M

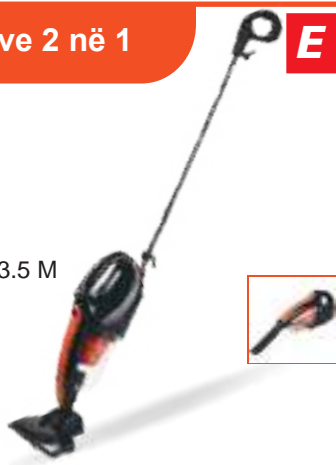

**E RE**

**Çmimi**  
3.900

## Fshesë korenti

### CEVC002B

- Fuqia: 1200 W
- Depozita: 2 L
- Presioni 22 kPa
- Gjatësia e kabullit: 4 m
- Funkzion treguesi të pluhurit
- Rrotullues automatik i kabullit

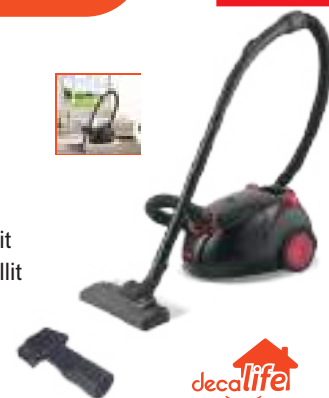

**E RE**

**Çmimi**  
5.990



## Pastruese me avull

### KEEN017W

- Fuqia: 1800 W
- Depozita: 1.5 L
- Presioni: 5 bar
- Gjatësia e kabullit: 2.5 m
- Koha e ngrohjes: 7 min
- Përfshirë 15 aksesore



**Çmimi**  
7.990



## Fshesë robotike

### DECABOT06

- Depozita: 450 ml
- Presioni: 1300 Pa
- Gyroscope style
- Koha e punës: 90 min
- Koha e karikimit: 4-5 orë
- Me furçë elektrike
- Me sensorë kundër ndërprerjeve



**E RE**

**Çmimi**  
15.900



## Hekur me pllakë tefloni

### KEEN019V

- Fuqia: 1200-1400 W
- Kapaciteti i depozitës: 150 ml
- Pllakë teflon
- Përmasa: 183 x100 mm
- Kontroll mekanik temperature
- Shkalla e avullit: 0-15 g/min



**Çmimi**  
1.390



## Hekur me pllakë telfoni

### KEEN001W

- Fuqia: 2000 W - 2400 W
- Kapaciteti i depozitës: 210 ml
- Pllakë telfoni
- 5 nivele nxehtësie
- Përmasa: 223 x 120 mm
- Kontrolli mekanik i temperaturës
- Shkalla e avullit: 30 g/min



**E RE**

**Çmimi**  
2.790





## Hekur me kaldajë

### KEEN006B

- Fuqia: 2000-2250 W
- Kapaciteti i depozitës : 1100 ml
- Pllakë qeramike
- Përmasa: 228 x120 mm
- Ngrohja paraprake: 40 S
- Shkalla e avullit: 40 g/min



**Çmimi**  
6.990



## Tharëse flokësh

### KEHS007W

- Fuqia: 1600 W
- Dorezë e palosshme
- 2 nivele shpejtësie
- 3 nivele nxehtësie
- 200 x 80 x 250 mm
- Gjatësia e kabullit: 1.65 m



**Çmimi**  
1.490

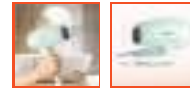

## Tharëse flokësh

**E RE**

### KEHS032L

- Fuqia: 1800-2200 W
- Kokë difuzori
- 2 nivele shpejtësie
- 3 nivele nxehtësie
- Gjatësia e kabullit: 1.8 M
- Difuzor + kokë

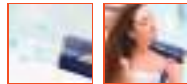

**Çmimi**  
1.990



## Tharëse flokësh

### KEHS011W

- Fuqia: 2200 W
- Funksion jonik
- 2 nivele shpejtësie
- 3 nivele nxehtësie
- 226 x 87 x 260 mm
- Gjatësi kabulli: 1.8 m + difuzor



**Çmimi**  
2.490

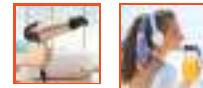

## Piastër flokësh

**E RE**

### KEHS034B

- Fuqia: 43W
- Kapaciteti: 12L
- Tensioni: 220-240 V
- Temperatura maksimale 210°C
- Me pllaka qeramike 120 x 25 mm
- Me funksion ndalimi
- Gjatësia e kabullit 1.7M
- Kursen deri në 60% energji



**Çmimi**  
1.190



## Ngrohëse 2000 W

### KEFH002W

- Fuqia: 2000 W
- Me termostat
- Kontroll automatik
- Mbrojtje nga mbinxehja
- Peshë: 1 kg
- 200 x 80 x 250 mm



**Çmimi**  
1.490



## Ngrohëse 2000 W

### KEFH003W

- Fuqia: 2000 W
- Me termostat
- Kontroll automatik
- Mbrojtje nga mbinxehja
- Peshë: 1.15 kg
- 260 x 260 x 120 mm



**Çmimi**  
1.890



## Ngrohëse me Quartz

### KEFH001B

- Fuqia: 1200 W
- Tensioni: 220-240 V
- 3 grupe ngrohjeje
- Me dorezë portative
- Mbrojtje nga mbinxehja
- Peshë: 1.6 kg
- 320 x 260 x 460 mm



**Çmimi**  
1.990

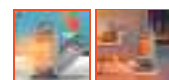

## Ventilator

**E RE**

### KEFC009B

- Fuqja: 60 W
- Tensioni: 220 V
- 3 nivele shpejtësie
- Ventilator 18"
- Diametri i bazës: 500 mm me vrime
- 5 helika plastike, skarë plastike 18"
- Lartësi e rregullueshme



**decaDeal**

**Çmimi**  
**3.390**

## Ventilator 3 në 1

**E RE**

### KEFC008B

- Fuqja: 60 W
- Tensioni: 220 V
- 3 nivele shpejtësie
- Ventilator 3 në 1, 18"
- Diametri i bazës: 500 mm me 5 vrime
- 5 helika plastike, skarë plastike 18"
- Lartësi e rregullueshme, 3 modele



**Çmimi**  
**3.690**

## Tavë elektrike

**E RE**

### KEEC051B

- Fuqja: 1500 W
- Mbrojtje nga mbinxehja
- Madhësia: 300 x 300 mm
- Materiali: jo ngjites me dy shtresa
- Dy doreza të izoluar
- Kapak xhami
- Dritë treguese e ndezjes/fikjes



**Çmimi**  
**2.790**

## Tavë elektrike për pica

### KEEC052B

- Fuqja: 1500 W
- Mbrojtje nga mbinxehja
- Madhësia: 320 x 300 mm
- Materiali: jo ngjites me 2 shtresa
- Doreza të izoluar
- Kapak xhami



**Çmimi**  
**2.590**

**decaDeal**

## Furrë elektrike

**E RE**

### KEEV007B

- Fuqja: 650 W
- Tensioni: 220-240 V
- Kapaciteti: 10 Lt
- Kontrolli i temp. 100°C~230°C
- Elementet ngrohëse me kuarc
- Dorezë inoxi

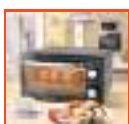

**Çmimi**  
**3.500**

## Mikrovalë

**E RE**

### KEMC007W

- Fuqja: 1150 W
- Tensioni: 220-240 V
- Kapaciteti: 20 L
- 6 nivele të fuqisë së mikrovalës
- Kohëmatësi i gatimit: 30 min
- Tabaka qelqi rrotulluese: 245 mm
- Sinjali i përfundimit të gatimit



**Çmimi**  
**10.500**

## Furnellë elektrike me 2 vatra

**E RE**

### KECC005B

- Fuqja: 1000 W + 1000 W
- Tensioni: 220-240 V
- 2 vatra
- 5 nivele nxehtësie
- Sipërfaqe gize
- E përdorshme tek të gjitha enët e gatimit metal, qelq, qeramikë



**Çmimi**  
**2.190**

**decaLife!**

## Furnellë gazi me 2 vatra

**E RE**

### KMGS013M

- Fuqja: 3.2 Kw + 3.2 Kw
- Presioni: 2800 Pa
- Diametri i vatrës: 90 mm
- Tub gazi në formë L
- Ndezja automatike
- Panel inoxi



**Çmimi**  
**3.790**



## Zgare me gas

### KMGS005B

- Fuqia: 5.5 kW
- Lartësia: 86 cm
- Zona e gatimit: 48.5 x 37.5 cm
- Injektori kryesore 0.84 mm, anësor 0.75 mm
- Valvula alumini
- Tavolinë anësore
- Kapak inoksi, me rrota

### Çmimi

18.500



**E RE**



## Zgarë me gas

### KMGS006B

- Fuqia: 11.5 kW
- Lartësia: 82 cm
- Zona e gatimit: 63 x 37 cm
- Valvula alumini, rrjetë gatimi
- Tavolinë anësore
- Kapak inoksi, me rrota

### Çmimi

37.500



**E RE**



## Zgarë me qymyr

### KMCC008B

- Lartësia: 82 cm, e rregullueshme
- Zona e gatimit: 58 x 42.5 cm
- Tabaka me qymyr
- 2 copë rrjetë gatimi me tela të kromuar
- Raft ngrohës me tela të kromuar
- Me rrota 50 x 25 mm
- Kapak inoksi

### Çmimi

21.500



**E RE**





**Barbekju me qymyr dhe rrota**



**BBQ1145**

- + tavoline dhe mbledhese 47 cm



Çmimi  
**4.290**

**Barbekju me qymyr, raft dhe rrota**



**BBQ1140**

- 50 x 26 cm



Çmimi  
**5.900**

**Barbekju me qymyr, raft dhe rrota**



**BBQ1160**

- Mbledhese hiri F 56cm



Çmimi  
**7.500**

**Barbekju me qymyr, raft dhe rrota**



**BBQ1170**

- 76x40 cm



Çmimi  
**13.500**

**Barbekju me gaz, kapak dhe rrota**



**BBQ2000**

- Fuqia: 7.2 Kw



Çmimi  
**23.500**

**Barbekju me gaz dhe 3 vatra**



**BBQ3000**

- Fuqia: 10.8kW
- Dimensione të rrjetit: 60 x 45cm
- Pa zgare anesore



Çmimi  
**27.900**

**Barbekju me gaz dhe 3 vatra**



**BBQ3100**

- Fuqia: 17.1kW
- Me zgare anesore



Çmimi  
**39.500**

**Rregullator gazi**



**BBQ1008**

- Rregullator gazi me tub
- Gjatesia e tubit ±60cm



Çmimi  
**1.790**

**Barbekju me qymyr dhe rrota**



**99580**

- 47x47x73



Çmimi  
**4.500**

**Tel zgare inoksi dysh**



**BBQ1001**

- Permasa: 35X25 cm



Çmimi  
**1.350**

**Set barbeque valixhe 16 copesh**



**BBQ1015**



Çmimi  
**5.900**

**Furce pastrimi per barbecue**



**BBQ1018**

- Permasa: 21 cm



Çmimi  
**290**

**Barbekju me qymyr, raft dhe rrota**



**99585**

- 82x33x85 cm



Çmimi  
**4.990**

**Tel zgare inoksi dysh me dopio mbajtëse**



Kodi	Te dhena	Paketimi	Cmimi
BBQ1004	35 x 25 cm	1 Cope	1.390
BBQ1011	35 x 25 cm	1 Cope	1.690

**Tel zgare inoksi**



**BBQ1017**

- Permasa: 40x30 cm



Çmimi  
**1.150**

**Tel zgare inoksi dysh per peshk**



**BBQ1019**

- Permasa: 66x14 cm



Çmimi  
**890**

## Zgarë portative me gas



**104997**

- Fuqia: 1.9 kW
- Shtresë jo ngjitëse
- Ideale për pjekje në sgarë
- Sipërfaqja: 27 X 34 cm



Çmimi  
**4.500**

## Zgarë portative me bombël të vogël



**104998**

- Bombël e vogël gazi
- Shtresë inoxi jo ngjitëse
- Ideale për kampe, shëtitje me varkë dhe gatim në natyrë
- Sipërfaqe: 34 X 25 cm



Çmimi  
**4.500**

## Furnellë elektrike



**104991**

- Fuqia: 450W
- Diametri: 90 mm
- Struktura Inoksi



Çmimi  
**1.590**

## Pjatë zgarë



**104987P**

- Pjatë për furnellë 104987
- Material kundër ngjitjes së gatimit
- Përmasa: 27 x 34 cm



Çmimi  
**1.390**

## Ngrohës ushqimi mini me gaz



**1059KIT**

- Ndezje me çentil
- Rregullator flake
- Bombël 227 gr
- Ideale për karamelizimin e ëmbëlsirave, skuqjen e mishit dhe thekjen e farave



Çmimi  
**2.390**

## Kokë për furnellë 106110



**106110**

- E përshtatshme për bombël gazi 2-3-5 Kg
- E sigurt në përdorim
- Kokë e kromuar
- Ideale për kamping dhe gatim në natyrë



Çmimi  
**1.400**

## Tymues ushqimesh



**SB-01**

- Lehtësisht i pastrueshëm
- Ideal për peshk, mish, preime e fruta
- Gjatësia e tubit lidhës 25 cm



Çmimi  
**1.990**

## Lageshtues ambjenti



**UMU-100**

- Depozitë 1.2 Lt
- Konsumi i kufizuar i energjisë
- Ideale për lagështimin e dhomës



Çmimi  
**2.500**



**Largues minjsh dhe gjarpërinjsh**



**AR-T2**

- Largues për minj dhe gjarpërinj me bateri
- Për ambiente deri në 625 m<sup>2</sup>
- Funksionon me tinguj dhe vibrim



Çmimi  
**1.990**

**Neon për vrasës insektesh**



**EIN-16**

- Fuqia: 8 watt
- Neon Rezerve



Çmimi  
**1.990**

**Vrasës mushkonjash me stiv**



**EIN-G**

- E pajisur me llampë 7 W
- E pajisur me kabëll 2 m
- E përshtatshme për çdo lloj
- Ndezje automatike me sensor drite
- ↙ mm 255 x 255 x 1100



Çmimi  
**4.990**

**Reflektor vertikal me tre llampa**



**ALN-1200**

- 3 nivele fuqie: 400/ 800/ 1200 W
- Sipërfaqe mbulimi 25 m<sup>2</sup>
- Lëkundje automatike 180°
- Sistem kundër animit
- Dorezë mbajtëse



Çmimi  
**3.990**

**Vrasëse insektesh elektrike**



**EIN-12**

- Dy llamba neoni 6 W
- Me sinjalizues për kapjen e miut



Çmimi  
**3.900**

**Vrasese insektesh elektrike**



**EIN-6**

- Fuqia: 1000 V
- E pajisur me llampë 6 W
- Rreze veprimi 20 m<sup>2</sup>
- E pajisur me sirtar për grumbullimin e insekteve + grep varës



Çmimi  
**1.590**

**Ngrohës elektrik Convex**



**TC-2000**

- 3 nivele nxehtësie 750/1250/ 2000 W
- Sipërfaqe mbulimi 20 m<sup>2</sup>
- Termostat të rregullueshëm
- Kundër mbinxehjes
- Doreza anësore
- Këmbë plastike kundër gërvishtjeve



Çmimi  
**3.900**

**Kalorifer me vaj**



**ERC2-1507**

- Fuqia: 1500 W
- 3 nivele gradimi
- Numri i fletëve: 7



Çmimi  
**9.900**

**Ngrohës elektrik me programim**



**TC-SPD2000**

- Fuqia 2000 W
- E pajisur me telekomandë
- Sipërfaqe mbulimi 20 m<sup>2</sup>
- Ideale për ngrohje ose ftohje
- Për temp. nga 10° deri në 49°



Çmimi  
**10.500**

**Stativ për reflektorin 65432KW20**



**AA602**

- Reflektor me stativ për ambiente të jashtme 1.5 - 2 Kw
- Llampë halogjene
- Kënd ngrohje i rregullueshëm
- Kënd ngrohje i rregullueshëm
- ↘ mm 590 x 110 x 77



Çmimi  
**5.500**

**Ngrohës me ventilim**



**TV-SL**

- Ngrohës elektrik me ventilim me dy nivele fuqie
- Termostat rregullues për ambientin
- Termostat rregullues për mbi-nxehjen
- ↘ mm 250 x 105 x 270



Çmimi  
**2.990**

**Ngrohës me ventilim**



**TV-T24**

- 2 nivele nxehtësie 1800/ 2000 W
- Siperfaqe mbulimi 20 m<sup>2</sup>
- Termostat të rregullueshëm
- Kundër mbinxehjes
- Funkzioni i ajrosjes gjatë verës
- Dorezë në pjesën e pasme



Çmimi  
**3.990**

**Reflektor muri**



**65432KW20**

- Reflektor muri për ambiente të jashtme 2 Kw
- Llampë halogjene
- Kënd ngrohje i rregullueshëm
- Kabëll 5.0 m
- Rezistente ndaj ujit
- ↘ mm 615 x 110 x 160



Çmimi  
**8.500**

**Ngrohëse me ventilim**



**TV-EC**

- Ngrohës me ventilim me 2 gradime ventilim dhe mbrojtje termike 2000W
- Temperaturë e rregullueshme
- I përshtatshëm për ambiente të vogla
- Me dorezë mbajtëse
- ↘ mm 205 x 130 x 250



Çmimi  
**1.990**

**Mini ngrohëse qeramike**



**CM-1500**

- Mini ngrohëse me pllakë qeramike
- Dy nivele fuqie 1000/ 1500 W
- Mbrojtje termike
- Termostat sigurie
- E pajisur me filtër ajri
- Sipërfaqe mbulimi 20 m<sup>2</sup>



Çmimi  
**3.900**

**Ngrohës me ventilim**



**BEH5200**

- 2 nivele nxehtësie 1000/ 2000 W
- Mbrojtje nga mbinxehja
- Termostat të rregullueshëm
- Kundër mbinxehjes
- Funkzioni i ajrosjes gjatë verës
- Dorezë në pjesën e pasme



Çmimi  
**3.900**

## Ngrohës me ventilim



### BEH5210

- 2 nivele nxehtësie 1000/ 2000 W
- Mbrojtje nga mbinxehja
- Termostat të rregullueshëm
- Kundër mbinxehjes
- Funkzioni i ajrosjes gjatë verës
- Dorezë në pjesën e pasme



Çmimi

**1.900**

## Ventilator tavoline



### BFN2025

- Fuqia: 40W
- 3 nivele shpejtesie
- 3 helika
- Ngjyra e bardhe



Çmimi

**2.990**

## Freskuese me shume helika



### BFN4015

- Fuqia: 45W
- 3 nivele shpejtesie
- 3 helika
- Ngjyra e bardhe



Çmimi

**6.500**

## Kondicioner per ftohje i bardhe



### BFN5615

- Fuqia: 65 W
- Me rrota dhe telekomande
- Depozite uji: 6 L
- Me 3 nivele shpejtesie
- Motor alumini



**IRI**

Çmimi

**7.990**

## Ventilator tavoline



### BFN1025

- Fuqia: 40W
- Diameter: 30 cm



Çmimi

**2.690**

## Ventilator Industrial



### BFN8115

- Fuqia: 80W
- Dimensioni: 50 cm
- 3 nivele shpejtesie
- 3 helika



Çmimi

**5.990**

## Freskuese murale



### BFN6110

- Fuqia: 70 W
- Permasa: 120 cm
- Me telekomande dhe drite



Çmimi

**12.900**

## Kondicioner



### BFN5610

- Fuqia: 80 W
- Dimensionet: 25 x 26.5 x 57 cm
- Me rrota dhe telekomande
- Depozite uji: 4 L
- Furnizimi me ajer: 300m<sup>3</sup>/h
- Motor alumini
- Pesha: 4.46 kg



Çmimi

**8.900**



## PRODUKTE SHTEPIAKE

Te lehta, elegante dhe perfekte për çdo ambient.

Komode dhe lehtësisht te palosshme dhe magazinueshme.

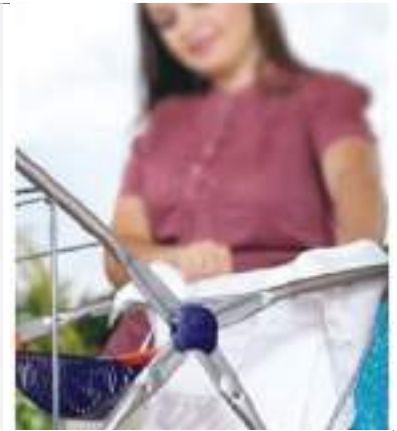

### Tavoline hekurosje Lux Tach

**2302**

- Sipërfaqja e sipërme e hekurosjes me rrjetë
- Mbulesa teflon rezistente ndaj nxehtë-
- Dizajn i veçantë për të lehtësuar hekurosjen
- Gjatesia: 1.75m, Gjerësia: 0.38m  
Lartësia: 1.48m, Pesha 4.6 kg



Çmimi  
**2.900**

### Tavoline hekurosje Evita

**2201**

- Rregullimi automatik i lartësisë 60 deri në 90 cm
- Sipërfaqja e sipërme e hekurosjes me rrjetë
- Dizajn i veçantë për të lehtësuar hekurosjen
- Gjatesia: 1.42m, Gjerësia: 0.34m  
Lartësia: 0.9m, Pesha 5.2 kg



Çmimi  
**3.390**

### Tavoline hekurosje Europa Capitol

**2206**

- Sipërfaqja e sipërme e hekurosjes me rrjetë
- Mbulesa teflon rezistente ndaj nxehtësisë
- Dizajn i veçantë për të lehtësuar hekurosjen
- Gjatesia: 1.43m, Gjerësia: 0.38m  
Lartësia: 0.9m, Pesha 7.21 kg

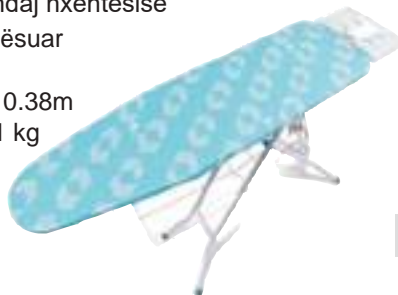

Çmimi  
**3.990**

### Tavoline hekurosje Rayan

**2226**

- Rregullimi automatik i lartësisë 60 deri në 90 cm
- Sipërfaqja e sipërme e hekurosjes me rrjetë
- Dizajn i veçantë për të lehtësuar hekurosjen
- Gjatesia: 1.55m, Gjerësia: 0.42m  
Lartësia: 0.91m, Pesha 7.8 kg



Çmimi  
**4.990**

### Tavoline hekurosje Flash New

**2228**

- Rregullimi automatik i lartësisë 60 deri në 90 cm
- Sipërfaqja e sipërme e hekurosjes me rrjetë
- Dizajn i veçantë për të lehtësuar hekurosjen
- Gjatesia: 1.67m, Gjerësia: 0.42m  
Lartësia: 0.9m, Pesha 8.5 kg



Çmimi  
**5.500**

### Tavoline hekurosje Flash New

**2229**

- Rregullimi automatik i lartësisë 60 deri në 90 cm
- Sipërfaqja e sipërme e hekurosjes me rrjetë
- Dizajn i veçantë për të lehtësuar hekurosjen
- Gjatesia: 1.58m, Gjerësia: 0.46m  
Lartësia: 0.95m, Pesha 9.35 kg



Çmimi  
**5.990**

**ERE**

**Nderese rrobash Platine Liva**

**3315**

- Nderese rrobash metalike
- Gjatesia: 1.80m, Gjeresia: 0.54m  
Lartesia: 1.15m, Pesha 2.85 kg

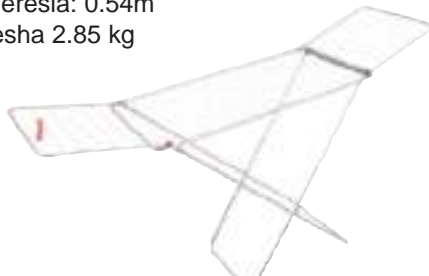

Çmimi  
**1.490**

**Nderese rrobash Caprice**

**3304**

- Nderese rrobash metalike
- Gjatesia: 1.74m, Gjeresia: 0.55m  
Lartesia: 1.11m, Pesha 4.10 kg

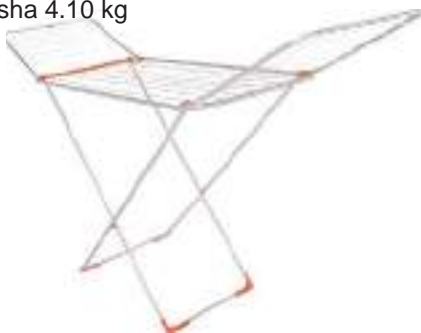

Çmimi  
**2.590**

**Nderese rrobash Define**

**ERE**

**3312**

- Nderese rrobash metalike
- Gjatesia: 1.80m, Gjeresia: 0.56m  
Lartesia: 1.17m, Pesha 2.55 kg



Çmimi  
**4.290**

**Mbulese per tavoline hekurosje**

**2701**

- Permasa: 130 x 45 cm



Çmimi  
**950**

**Nderese rrobash Rennie M**

**ERE**

**3302**

- Nderese rrobash m
- Gjatesia: 1.89m, Gjeresia: 0.61m  
Lartesia: 0.9m, Pesha 4.1 kg



Çmimi  
**1.490**

**Nderese rrobash Begonia**

**ERE**

**3308**

- Nderese rrobash metalike me mbajtese te dyfishte
- Gjatesia: 1.80m, Gjeresia: 0.38m  
Lartesia: 0.5m, Pesha 2.11 kg



Çmimi  
**3.790**

**Nderese rrobash Cabrice**

**ERE**

**3316**

- Nderese rrobash metalike
- Gjatesia: 1.80m, Gjeresia: 0.60m  
Lartesia: 1.60m, Pesha 7 kg

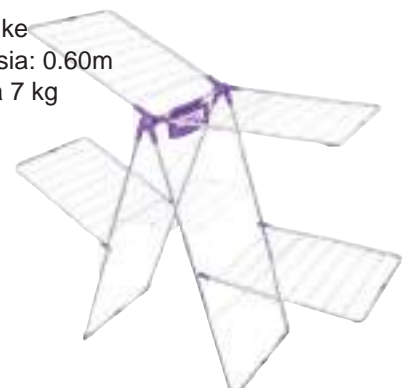

Çmimi  
**4.290**

**Mbulese per tavoline hekurosje**

**2702**

- Permasa: 140 x 52 cm



Çmimi  
**990**



**Cader per kopesht me bazament**

**BSP1030**

- Lartesia: 3 m
- Bazamenti: 48 mm



Çmimi  
**9.900**

**Cader per kopesht**

**BSP1035**

- Lartesia: 3 m
- Diametri i tubit: 3 mm



Çmimi  
**6.500**

**Set per verande**

**BSP1168**

- Karrige njevendeshe x 2
- Nje karrige dyvendeshe x1
- Tavoline katrore xhami



Çmimi  
**19.900**

**Lekundese per 3 persona**

**BSP1050**

- Struktura metalike
- Permasa: 170x100x153 cm
- 3 Persona



Çmimi  
**12.500**

**Lekundese per kopesht**

**BSP1122**

- Permasa: 275x140 cm



Çmimi  
**2.290**

**Karrige per verande ngjyre gri**

**BSP1130**

- Permasa: 55x78x91 cm



Çmimi  
**3.690**





**Tavoline xhami per verande**

**BSP1140**

- Permasa: 150x90x72 cm
- Struktura metalike



Çmimi  
**11.900**

**Set me 4 karrige te palosshme**

**BSP1152**

- Strukture metalike
- Ngjyra: Gri



Çmimi  
**4.690**

**Tavoline plastike me xham te zi**

**BSP1156**

- Permasat: 150x90x72 cm
- Strukture alumini



Çmimi  
**16.900**

**Tavoline xhami per verande**

**BSP1145**

- Permasa: 60x72 cm
- E rrumbullaket
- Struktura metalike



Çmimi  
**3.990**

**Jastek per karrige te jashtme**

**BSP1154**

- Permasat: 50x100x8 Cm



Çmimi  
**2.200**

**Karrige metal gri e palosshme**

**BSP1164**

- Strukture metalike
- Permasa: 52x43x80 cm



Çmimi  
**2.990**

**Tavoline pikniku e palosshme**

**BSP1149**

- Permasa: 80x60x70 cm
- Kembe metalike

**ERE**



Çmimi  
**3.200**

**Tavoline dhe 4 karrige potative**

**BSP1150**

- Alumini

**ERE**



Çmimi  
**5.990**

**Tende e palosshme**

**BSP1025**

- Permasa: 3x3 m
- Rezistente ndaj ujit
- E palosshme

**ERE**



Çmimi  
**10.500**

**Cader plazhi me korniza metali**

**BSP1037**

- Permasa: 200xH200 cm

**ERE**



Çmimi  
**2.200**

**Bazament per cader kopeshti**

**BSP1040**

- Diameter bishti: 38/48 mm

**ERE**



Çmimi  
**3.690**

**Shezllon me strukture metali**

**BSP1170**

- Permasa: 66x153x104 cm
- Kapacitet: 100 kg
- Gri

**ERE**



Çmimi  
**5.500**

**Karrige portative plazhi gri**

**BSP1176**

- Struktura metalike
- Permasa: 53x55x73 cm

**ERE**



Çmimi  
**1.890**

**Karrige portative plazhi blu**

**BSP1175**

- Struktura Metalike
- Permasa: 66x153x104 cm

**ERE**



Çmimi  
**1.790**

**Poltrol lekundes**

**BSP1166**

- Permasa: 95 x 95 x 196 cm

**ERE**



Çmimi  
**29.900**



**Kuti magazinimi plastike**

**BPC5000**

- Permasa: 8.7x4x12.2 cm

**ERE**



Çmimi  
**5.990**

**Dollap plastik**

**BPC4000**

- 1 Ndarje
- Permasa: 92x68x36 cm

**ERE**



Çmimi  
**7.500**

**Dollap plastik me 4 ndarje**

**BPC7000**

- 4 Ndarje
- Permasa: 171x68x38 cm

**ERE**



Çmimi  
**11.500**

**Dollap plastik me 3 ndarje**

**BPC6000**

- 3 Ndarje
- Permasa: 171x68x38 cm

**ERE**



Çmimi  
**9.900**

**Raft I palosshem per garderobe**

**BPC1500**

Permasa 130 x 45 x 175 cm  
Bazament Metalik

**ERE**



Çmimi  
**3.990**

**Raft metali me 3 ndarje**

**BTW9044**

- Per lavatrice
- Permasa: 68x25x166 cm
- I bardhe

**ERE**



Çmimi  
**3.500**



**Tapet bari artificial**

**ERE**

Kodi	Permasa	Çmimi
<b>BPN2110</b>	20 mm x 1 m x 25 m	<b>29.000</b>
<b>BPN2130</b>	20 mm x 2 m x 10 m	<b>29.900</b>

**Shtrese per tapete bari**

**ERE**

Kodi	Permasa	Çmimi
<b>BPN1300</b>	1 m x 10 m 90 Gsm	<b>990</b>
<b>BPN1305</b>	2 m x 50 m 90 Gsm	<b>7.500</b>

**Pani rjete hije per mbulim serash**

Kodi	Permasa	Çmimi
<b>SN1500</b>	125Gsm 90%, 1x50m	<b>5.990</b>
<b>SN1550</b>	125Gsm 90%, 1,5x50m	<b>9.900</b>
<b>SN2050</b>	125Gsm 90%, 2x50m	<b>11.500</b>
<b>SN3050</b>	125Gsm 90%, 3x50m	<b>18.500</b>
<b>SN4050</b>	125Gsm 90%, 4x50m	<b>22.500</b>
<b>SN5050</b>	125Gsm 90%, 5x50m	<b>27.500</b>
<b>SN6050</b>	125Gsm 90%, 6x50m	<b>35.900</b>

**MBULESE UNIVERSALE**

Kodi	Permasa	Çmimi
<b>BTR2000</b>	2 m x 3 m 60 Gr	<b>490</b>
<b>BTR2040</b>	4 m x 6 m 60 Gr	<b>1.900</b>
<b>BTR2050</b>	5 m x 8 m 60 Gr	<b>2.500</b>
<b>BTR2060</b>	6 m x 10 m 60 Gr	<b>4.250</b>

**Rrjete dekorative me gjethe**
**BPN1200**

- Gjatesia: 3 x 1 m

**Çmimi**  
**4.900**

**Mbulese per hije**

**88740**

- Gjatesia: 1.5m x 10 m,  
90 gsm

**Çmimi**  
**2.500**

**Rrjete sigurie plastike per ballkone**



Kodi	Permase	Çmimi
<b>BPN1450</b>	1 m x 50 m E bardhe	<b>8.900</b>
<b>BPN1550</b>	1 m x 50 m E zeze	<b>8.900</b>
<b>BPN1650</b>	1 m x 50 m Gri	<b>8.900</b>
<b>BPN1750</b>	1 m x 50 m Jeshile	<b>8.900</b>

**Rrjete sigurie plastike per ballkone**



**ERE**

Kodi	Permase	Çmimi
<b>BPN1850</b>	1.2 m x 50 m E bardhe	<b>9.900</b>
<b>BPN1950</b>	1.2 m x 50 m E zeze	<b>9.900</b>
<b>BPN2050</b>	1.2 m x 50 m Gri	<b>9.900</b>

**Top rrjete teli zingato me saldim**



**ERE**

Kodi	Permase	Çmimi
<b>BDA2020</b>	1 m x 25 m / 12.2 Kg	<b>7.500</b>
<b>BDA2025</b>	1 m x 25 m / 8.3 Kg	<b>5.390</b>

**Top rrjete teli zingato**



**ERE**

Kodi	Permase	Çmimi
<b>BDA2000</b>	0.8 m x 25 m / 6.6 Kg	<b>2.990</b>
<b>BDA2005</b>	1.0 m x 25 m / 8.3 Kg	<b>3.590</b>
<b>BDA2010</b>	1.0 m x 25 m / 9.9 Kg	<b>4.590</b>
<b>BDA2015</b>	1.2 m x 25 m / 4.8 Kg	<b>2.390</b>

**Top rrjete gri per dritare**



**ERE**

Kodi	Permase	Çmimi
<b>BDA2030</b>	0.8 m x 30 m / 1/2"	<b>3.590</b>
<b>BDA2035</b>	1.0 m x 30 m / 1/2"	<b>4.290</b>
<b>BDA2040</b>	1.2 m x 30 m / 1/2"	<b>5.290</b>
<b>BDA2045</b>	1.5 m x 30 m / 1"	<b>6.390</b>

**Mbulese universale shiu**

**VOREL**



Kodi	Permase	Çmimi
<b>85122</b>	2m x 3m, 57 gsm	<b>250</b>
<b>85124</b>	4m x 5m, 57 gsm	<b>950</b>
<b>85116</b>	5m x 8m, 75 gsm	<b>2.500</b>
<b>85118</b>	6m x 10m, 75 gsm	<b>2.900</b>

## PROFESSIONAL SERVICE

Jemi të lumtur t'ju shërbejmë edhe pas shitjes. Ne ju ofrojmë një shërbim të shkëlqyer servisi, që bën dallimin midis një blerjeje rutinë dhe një partneriteti afatgjatë. Ecuria jonë e gjatë në fushën e shërbimit teknik na ka lejuar të krijojmë një rrjet të fortë bashkëpunimi me klientët tanë, duke u ofruar atyre jo vetëm një shërbim cilësor, por edhe një eksperiencë të paharrueshme. Me poshtë do të gjeni listën e çmimeve të shërbimit të servisit, ku vegla juaj do të kthehet në gjendje funksionale e gatshme për të kryer punët sikur të ishte e re. Ne jemi këtu për t'ju ndihmuar në çdo mënyrë që të mundemi.



KATEGORIA	LLOJI I DIFEKTIT	EASY PRO	COMFORT PRO	PREMIUM PRO
ELEKTROKOSA, FRYRESE GJETHESH ELEKTRIKE	DIFEKT MEKANIK	1,500	2,500	3,500
	DIFEKT ELEKTRIK	1,900	2,900	4,500
KORRESE BARI ELEKTRIKE, ELEKTROSHARRA KRASITASE LIGUSTRASH	DIFEKT MEKANIK	3,500	4,500	6,900
	DIFEKT ELEKTRIK	4,500	4,900	7,900
TRAPAN ELEKTRIK GURE FLEKSIBEL I VOGEL	DIFEKT MEKANIK	1,500	2,500	3,500
	DIFEKT ELEKTRIK	1,900	2,900	4,500
TRAPAN ME BATERI	DIFEKT MEKANIK	1,500	2,500	3,900
	DIFEKT ELEKTRIK	1,900	2,900	5,500
MATRAPIK SDS-PLUS GURE FLEKSIBEL I MADH,	DIFEKT MEKANIK	3,500	4,500	6,900
	DIFEKT ELEKTRIK	4,500	5,500	7,900
MATRAPIK SDS-MAX	DIFEKT MEKANIK	5,900	8,900	14,500
	DIFEKT ELEKTRIK	6,900	9,900	16,500



KATEGORIA	LLOJI I DIFEKTIT	EASY PRO	COMFORT PRO	PREMIUM PRO
POMPA UJI SIPERFAQESORE	DIFEKT MEKANIK	1,500	2.500	3.500
	DIFEKT ELEKTRIK	1,900	2,900	3,900
POMPA ZHYTESE PUSI 4"	DIFEKT MEKANIK	5,500	7.900	12,500
	DIFEKT ELEKTRIK	6,500	8,900	14,500
LARESE ME PRESION DHE ASPIRATORË	DIFEKT MEKANIK/ ELEKTRIK	4,500	6,500	9,500
MAKINERI ME MOTOR 2T ME BENZINE MOTOKOSA MOTOSHARRA	DIFEKT MEKANIK	3,900	4,900	6,900
	DIFEKT MOTORIK	4,900	6.900	9,900
MAKINERI ME MOTOR 4T ME BENZINE KORRESE BARI FREZA	DIFEKT MEKANIK	5,900	7,500	11,500
	DIFEKT MOTORIK	7,900	9,900	14,500
SHARRA ME MAJA SHARRA RRETHORE ZMERILUESE ELEKTRIKE	DIFEKT MEKANIK	2,500	3.500	5,500
	DIFEKT ELEKTRIK	2,900	3,900	7,500
TRONKATRICE ELEKTRIKE	DIFEKT MEKANIK	5,900	7.500	11,500
	DIFEKT ELEKTRIK	7,900	9.900	14,500
VEGLA ME AJER	DIFEKT MEKANIK	2,500	3.500	4.500
KOMPRESORET 24-50 LIT	DIFEKT MEKANIK	3,500	5,500	6,500
	DIFEKT ELEKTRIK	4.500	6.500	7,500
KOMPRESORET 100-200 LIT	DIFEKT MEKANIK	12.500	14,500	17,500
	DIFEKT ELEKTRIK	13.500	16,500	19,500
KOMPRESORET 300-500 LIT	DIFEKT MEKANIK	24,500	34,500	45,500
	DIFEKT ELEKTRIK	27,500	37,500	49,500

## PROFESSIONAL SERVICE



Ne ju garantojmë pjesët origjinale, për të gjitha makineritë e shitura nga ne, në 10 vitet e fundit. Të gjitha këto pjesë mund të porositen, me çmimet më të mira në treg, në pikat më të afërta të shitjes, si edhe pranë serviseve të autorizuara. Aktualisht ne kemi investuar në një stok të qëndrueshëm me rreth 3.000 pjesë këmbimi.

MOTOKOSE

52 CC

CGTB52



1E44F-2A-1

1E44F-2A.1

1E44F-2A.1



Cilinder

1E44F-2A.2-1



Karburator

1E44F-2A.2-4



Bobine ndezese

1E40F-5A.4.1



Piston

1E40F-5.11



Fasho pistoni

1E40F-5.7-1



Serbator

CG305F.1-4



Starter komplet



Starter i brendshem



Dado e kundert

MOTOKOSE

43-33-25.4 CC

CGTB43-33-25cc



CG415.2

1E34F.13

1E34F-12



Xhunto transmi.

CG330B.1



Karburator

1E32FL.6.2



Bobine ndezese

1E40F-5B.4.1



Tub + shufer  
trasmisioni

CG420.2-3



Tape serbatori

CG260B-CE.1.1



Serbator

CG260.2.1



Shufer transmisioni



Doreze gazi



Kembane freksioni

## GJENERATOR 63CC

### LT950DC



305800LT950DC



Cilinder

3058000005001



Guarnicion cilindri

30580KLT950DC



Koke cilindri

3058000031003



Piston

30580ULT950DC



Fasho pistoni

3012002000001



Celes

3058000037001



Karburator

3058000028001



Kollodok + bielle

3058000012001



Kapak starteri

## MOTOR ME BENZINE

208 CC

### LT210



G1214E1201000



Cilinder

G1311E0101000



Piston

G1320E0101000



Fasho pistoni

G1230E0102000



Guarnicion cilindri

G1501E0101H20



Sinjalizues vaji

1E40F-5B.4.1



Celes fikje

G1668E0101010



Valvul kontrolli

CG260B-CE.1.1



Tape benzine

CG260.2.1



Kapak starteri

## GJENERATOR ME NAFTE 2 KW

### LDG2200CLE



46LTP



Rrota rezerve 8"

2019000205001



3049010400500



Piston

2010000003000



Depozite benzine

## POMPA VOLUMETRIKE

### FB60/ FB70/FB80



FB60-H/FGPB125



Helike pompe FB60

FB60-P/FGP125



Permistop FB60

FB80-H



Helike pompe FB80

FB70-P



Permistop FB70

## POMPA PRESIONI

### FET100- 200



FET100-H



Helike pompe FET100

FET150-H



Helike pompe FET15

FET200-H



Helike pompe FET200

FXH-2540



MUFTE KABLLI POMPE PUSI

## POMPA CENTRIFUGALE

### FCP130 - FCP170-H



FCP130-H



Helike pompe FCP130

FCP158-H



Helike pompe FCP158

FCP170-H



Helike pompe FCP170

FCP200-H



Helike pompe FCP130



## KORRESE BARI

51 cm

GLM196201



GLM196201-SP-103



Piston

GLM196201-SP-2



Kapak starteri

GLM196201-SP-63



Filter ajri

GLM196201-SP-71



Karburator

GLM196201-SP-B15



Rrote komplet 8"



Thike

## GJENERATOR NAFTE SILENCIOZ

GSE50003



GSE50003-SP-1-7-8



Rregullator tensioni

GSE50003-SP-B10-11



Rregullator rryme karikimi

GSE50003-SP-B10-9



Pakete

GSE50003-SP-B2-5



Helike motor

GSE50003-SP-B7-22



Filter benzine

GSE50003-SP-B9-1



Celes starti

## POMPE CENTRIFUGALE

CPM7508



CPM7508-SP-10



Premistop

CPM7508-SP-18



Kondesator

CPM7508-SP-39



Freskuese

CPM7508-SP-40



Mbrojtese ventitalori

CPM7508-SP-9



## FREZE TOKE

6.5 hp

GC6101



GC6101-SP-7-1



Thike freze e majte

GC6101-SP-8-7



Koperton gome 3.5-6

GC6101-SP-E6-5



Kapak starti

GC6101-SP-E7-1



Bobine

## POMPE UJI

370 W

VPM37018



VPM37018-SP-11



Premistop

VPM37018-SP-15



Kapak i siperm

VPM37018-SP-26



Freskuese

VPM37018-SP-6



Valvul sigurie

VPM37018-SP-7



Unaze

VPM37018-SP-8



Helike

## POMPE JET

750 W

JP07508



JP07508-SP-15



Helike

JP07508-SP-16



Premistop

JP07508-SP-43



Freskuese

JPT07508-SP-47



Tub flesibel

## MOTOSHARRE KRASITSE ME BENZINE

GCS5261011



GCS5261011-SP-16    GCS5261011-SP-24-26    GCS5261011-SP-33



Pompe vaji



Freksion



Filter benzine

GCS5261011-SP-55    GCS5261011-SP-56    GCS5261011-SP-59



Piston



Fasho Pistoni



Cilinder per motosharre krasitese

GCS5261011-SP-67    GCS5261011-SP-80    GCS5261011-SP-95



Bobine ndezje



Kapak starti



Karburator

## KORRESE ELEKTRIKE

380 cm 1600 W

LM385



LM385-SP-11    LM385-SP-28    LM385-SP-30



Kase plastike



Rrip motori



Thike per Korrese

LM385-SP-36    LM385-SP-4-13    LM385-SP-7



Set rotash



Motori elektrik



Kuzhinete

## MOTOPOMPE BENZINE

2"

GWP202



GWP202-SP-12    GWP202-SP-1-25    GWP202-SP-1-39



Helike



Karburator



Piston

GWP202-SP-1-52    GWP202-SP-1-54



Kapak starteri



Bobine ndezje

## MOTOKOSE

52 CC

GBC5524421



GBC5524421-SP-1-22    GBC5524421-SP-1-36    GBC5524421-SP-1-40



Filter ajri sfungjer



Karburator



Bobine ndezese

GBC5524421-SP-1-41    GBC5524421-SP-1-5    GBC5524421-SP-1-52



Cilinder



Starter komplet



Fasho pistoni

GBC5524421-SP-1-53-5    GBC5524421-SP-1-57    GBC5524421-SP-1-8



Piston komplet



Serbator



Starter i brendshem

## KORRESE BARI

46 cm

GLM141181



GLM141181-SP-27    GLM141181-SP-50    GLM141181-SP-90-B39



Karburator



Piston



Tel Gazi

GLM141181-SP-90-B3    GLM141181-SP-96    GLM141181-SP-90-B12



Thike



Kapak starteri



Set rotash 8"

## MOTOPOMPE NAFTE

2"

GEP201



GEP201-SP-38    GEP201-SP-44



Rubinet benzine



Filter benzine

GEP201-SP-47    GEP201-SP-A.F.A



Injektor nafte



Filter ajri

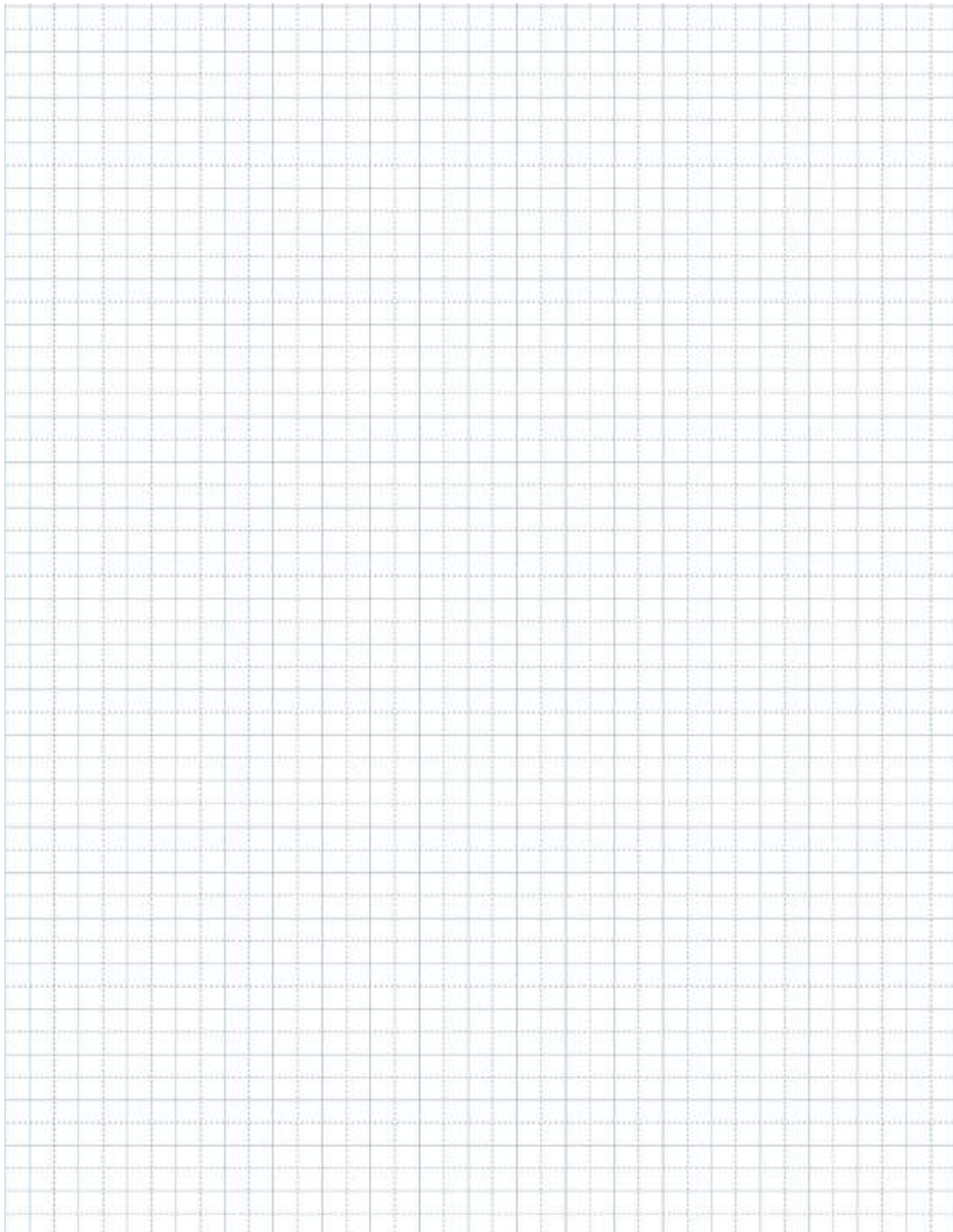



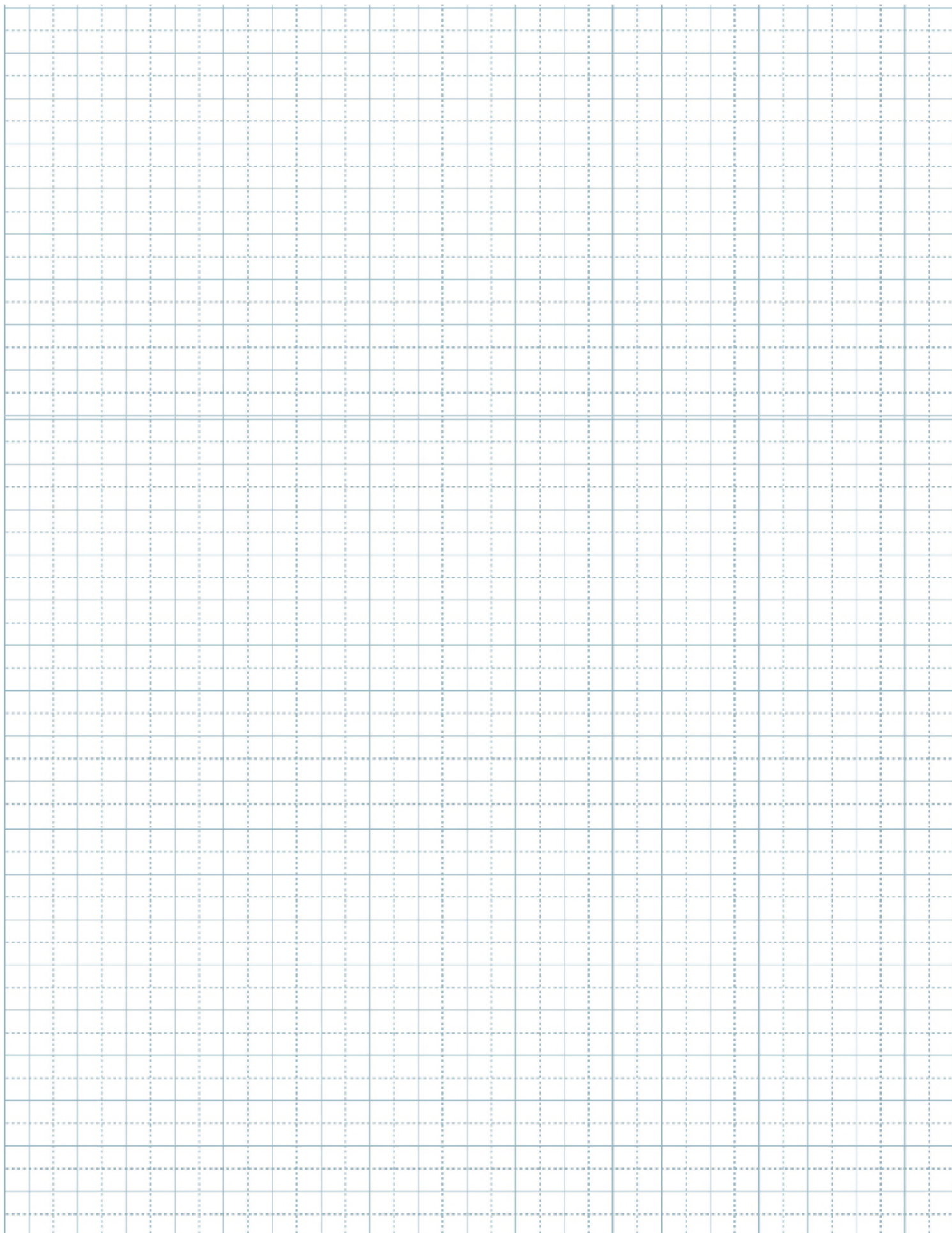





## GM1200



Çmimi  
**21.500**

### Motor i jashtëm elektrik

- Fuqia: 480 W
- Shpejtesi: 5 përpara 3 mbrapsht
- Helika: 210 mm
- Lartësia e aksit: 91.4 cm
- Ideal për varka të vogla
- Lartësi e rregullueshme

## GM1500



Çmimi  
**27.500**

### Motor i jashtëm 4-kohësh

- Fuqia: 1.5 HP
- Autonomia: 40 min
- Helika: 180 mm
- Lartësia e aksit: 43 cm
- Ideal si motor ndihmes
- Lartësi e rregullueshme

## GM2500



Çmimi  
**59.900**

### Motor i jashtëm 4-kohësh

- Fuqia: 6.5 HP
- Ftohje me ujë
- Helika: 200 mm
- Lartësia e aksit: 43 cm
- Ideal si motor ndihmes
- Lartësi e rregullueshme